



CITYMULTI[®] CATALOG

VARIABLE REFRIGERANT FLOW ZONING SYSTEMS



CITY MULTI CATALOG | 05.2018 | ©2018 MITSUBISHI ELECTRIC TRANE US HVAC, LLC.

trane.com/ductless

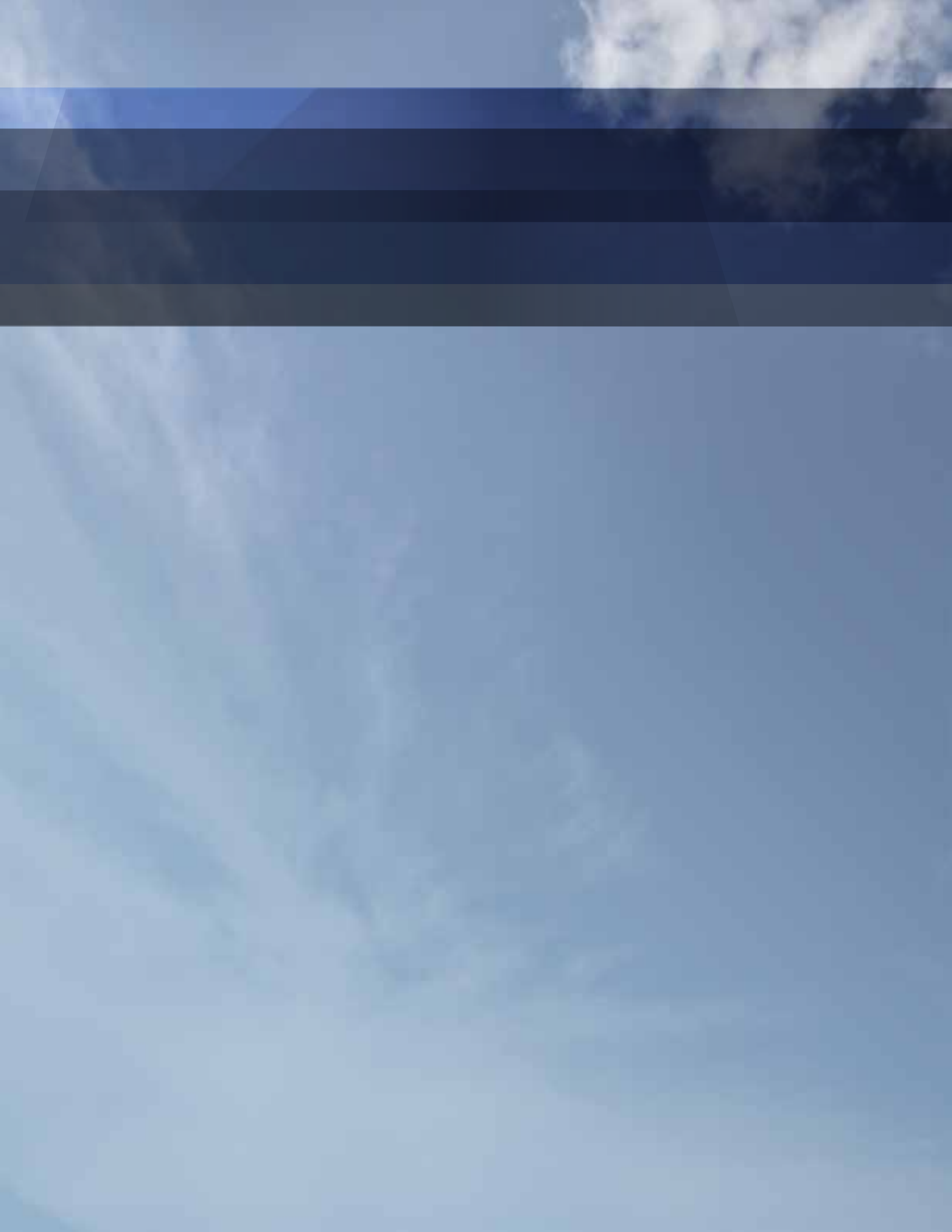

TABLE OF CONTENTS

Overview of CITY MULTI®	5
Product Advantages	10

OUTDOOR UNITS

Outdoor Units Showcase.	14
R2-Series.	17
Y-Series.	20
H2i® R2-Series	22
H2i® Y-Series.	23
S-Series (PUMY)	25
W-Series	26
Low Ambient Cooling Kit.	28
Cold Weather Solutions Guide	29
Linear Expansion Valve (LEV) Kit	31

INDOOR UNITS

Indoor Units Overview	34
PKFY (Wall-mounted).	35
PLFY (Four-way Ceiling Cassette)	36
PMFY (One-way Ceiling Cassette)	39
PCFY (Ceiling-suspended)	40
PEFY (Ceiling-concealed Ducted)	41
FB (M,L,H) Filter Boxes	43
PFFY (Floor-standing).	44
PVFY (Multi-position Air Handler).	45
PWFY (Hydronic Heat Exchanger).	46

VENTILATION

Lossnay® Energy Recovery Ventilators (ERVs)	50
Dedicated Outdoor Air System (DOAS).	51
Controls Network	54

CONTROLS AND SOFTWARE TOOLS

Integrated Centralized Control Web	55
License Options For Centralized Controllers	56
Centralized Controller AE-200A/AE-50A	57
Centralized Controller EW-50A	59
Centralized Controller TC-24B.	60
Input/Output Controllers	61
Zone Controllers	63
kumo cloud®.	65
Zone Controllers	65
AdvancedHVAC Controller	66
System Integration	67
Diamond Controls®.	68
Diamond Controls Applications.	69
Diamond System Builder®	70
Maintenance Tool	72

SPECIFICATIONS 73



WHY CITY MULTI® VRF SYSTEMS?

CITY MULTI ADVANTAGES:

- ▶ **Ultra-efficient design** to ensure total comfort in any commercial space.
- ▶ **Advanced INVERTER technology** varies the speed of the compressor for more efficient cooling and heating.
- ▶ **Complete zoning control** so you heat and cool the areas that need it without paying for the ones that don't.
- ▶ **Design flexibility** for any application, from modern designs to historic renovations.
- ▶ **Complete product family** to handle every job from the smallest spaces to the largest buildings and campuses.
- ▶ **Sustainable technology** that contributes to Leadership in Energy & Environmental Design (LEED) credits and saves energy.
- ▶ **Quiet operation** that's even softer than a human whisper.
- ▶ **Simultaneous operation** to cool and heat with just two refrigerant pipes.

QUIET OPERATION

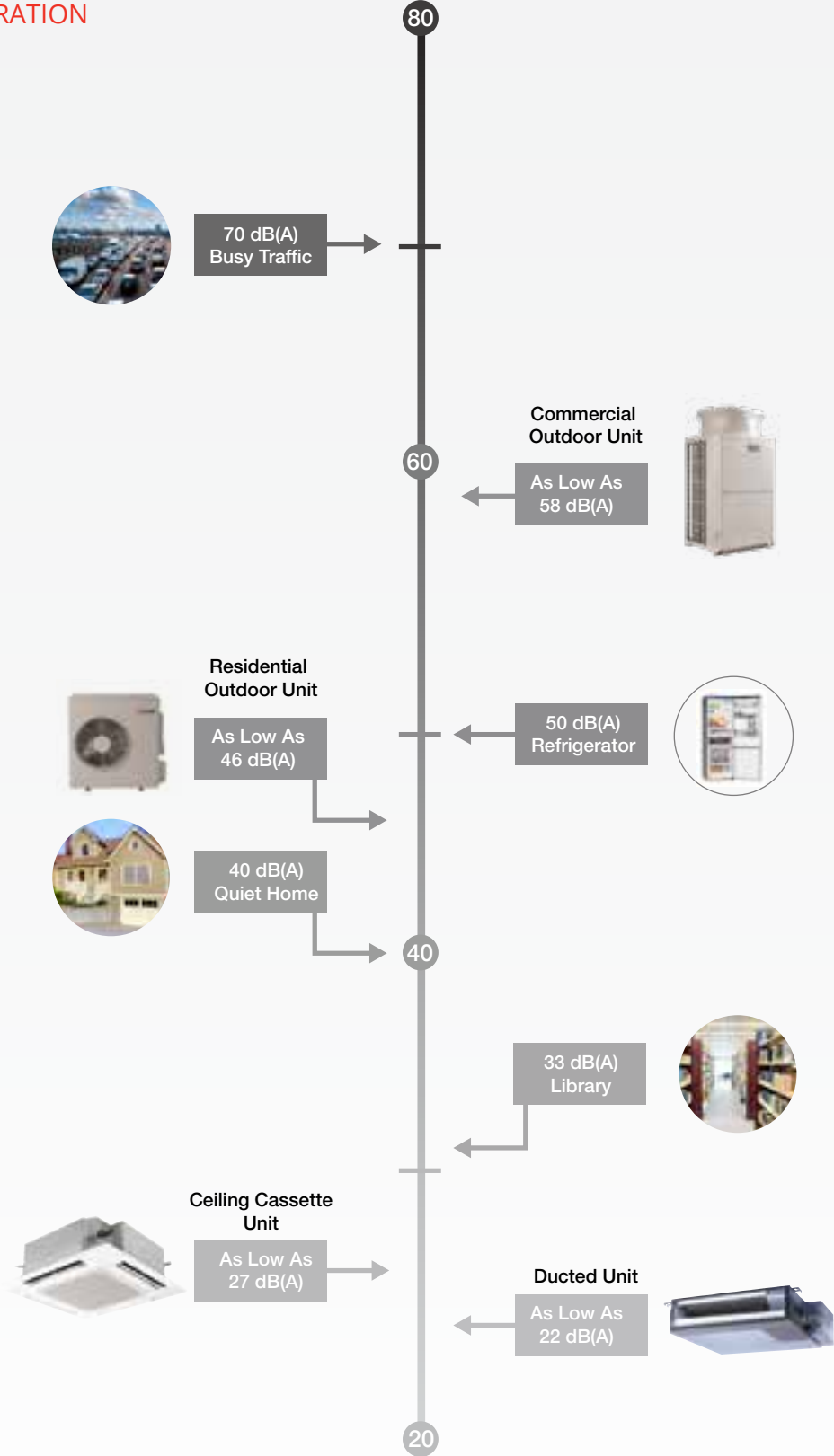

PRODUCT OVERVIEW

OUTDOOR UNITS

We offer an extensive air-source and water-source unit lineup that can be tailored to any application's requirements.

AIR-SOURCE HEAT RECOVERY



H2i® R2-Series



R2-Series

AIR-SOURCE HEAT PUMPS



H2i® Y-Series



WY-Series

WATER-SOURCE HEAT PUMP



WR2-Series

WATER-SOURCE HEAT RECOVERY



Y-Series



S-Series



INDOOR UNITS

Our wide range of indoor units enables you to choose the style and size that meets your requirements for layout and design.



PKFY
Wall-mounted



PMFY
Ceiling Cassette (1-way)



PCFY
Ceiling-suspended



PVFY
Multi-position Air Handler



PLFY-NEMU (33"x33")
PLFY-NCMU (22"x22")
Ceiling Cassette (4-way)



PWFY-NMU-E2-AU (HEX)
PWFY-NMU-E-BU (Booster)
Hydronic Heat Exchanger



PEFY-NMSU Low Profile
PEFY-NMAU Medium Static
PEFY-NMHU /NMHSU High Static
Ceiling-concealed Ducted



PFFY-NEMU Exposed
PFFY-NRMU Concealed
Floor-standing

CITY MULTI® CONTROLS NETWORK (CMCN)

The flexibility of CITY MULTI controls allow you to select the level of control and integration that fits the application's needs.

CENTRALIZED CONTROLLERS



AE-200A/AE-50A
Touch Screen
Centralized Controllers
(Browser Capable)



EW-50A
Centralized Controller
(Browser Capable)



TC-24B
Touch Screen
Centralized Controller



ICCW
Integrated Centralized
Control Web

ZONE CONTROLLERS



PAR-FL32MA
Wireless MA
Remote Controller



PAC-YT53CRAU
Simple MA
Remote Controller



PAR-33MAA
Wired MA
Remote Controller



PAR-U01MEDU
SmartME
Remote Controller



PZ-60DR
Lossnay® Remote Controller



PZ-43SMF
Lossnay® Remote Controller



kumo cloud®
App-based Controller

CUSTOM CONTROL SOLUTIONS



PAC-YG60MCA (PI)
PAC-YG63MCA (AI)
PAC-YG66DCA (DIDO)
I/O Control Boards



AHA-01(-04)-A
AdvancedHVAC
Applications



LMAP04U
LonWorks® Interface



DC-8000
Diamond Controls™ Building
Management System



PAC-US444CN
Thermostat Interface

PRODUCT ADVANTAGES

CITY MULTI® HIGH-PERFORMANCE, MODULAR VRF SYSTEMS

CITY MULTI outdoor units feature a lightweight modular design with a minimal footprint, lower sound level, easy piping, maintenance and much more.

1. INVERTER-DRIVEN COMPRESSOR TECHNOLOGY

The compressor varies its speed to match the indoor cooling or heating demand to consume only the energy required. No other compressor design can match the efficient performance.

2. EASY MAINTENANCE

In many cases, the systems allow an indoor unit to be serviced while other indoor units within the same piping system are still in operation. Indoor units only require periodic filter changes and cleaning. Protective coating comes standard on air-source outdoor units to lengthen coil life while additional Bermuda Special treatment, designated -BS within the model number, provides enhanced protection for the rest of the outdoor unit in sea-coast environments.

3. LONG LINE LENGTHS

The R2- and Y-Series outdoor units allow for long line lengths to the connected indoor units. Maximum total length of refrigerant piping is up to 2,624 feet for R2-Series and up to 3,280 feet for Y-Series.

4. ADJUSTABLE STATIC PRESSURE

R2-, Y- and H2i® R2- and Y-Series outdoor fan features adjustable static pressure up to 0.24" W.G., enabling the use of louvers or ductwork in its installation. The static pressure setting is adjustable by changing a dip switch. The default setting is 0" W.G., with options for 0.12" and 0.24" W.G.

5. QUIET OPERATION

CITY MULTI air-source outdoor units operate at sound levels as low as 58 dB(A)—the level of a common office environment, restaurant conversation or background music. Water-source units operate as low as 47 dB(A). Contributing features include our INVERTER-driven compressor compartment sealed by insulation-lined metal panels, vibration-absorbing compressor mounts, INVERTER-driven fan and Low Noise operating mode.

LOW AMBIENT OPERATION

CITY MULTI systems provide 100% cooling capacity down to -10° F with the optional low ambient kit. Systems provide guaranteed heating operation down to -13° F. See pages 28 and 29 (Low Ambient Cooling) for more information.



ILLUSTRATION PURPOSES ONLY



Outdoor units featuring cold weather accessories, including hail and snow guards.

OUTDOOR UNITS

R2-Series/H2i® R2-Series/Y-Series/H2i® Y-Series/S-Series/W-Series



OUTDOOR UNITS SHOWCASE

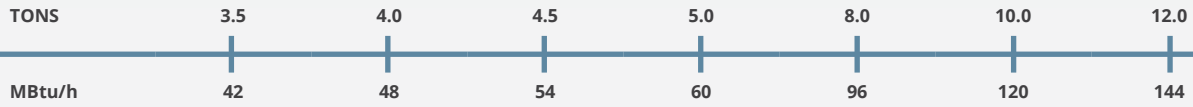

R2-Series Heat Recovery
PURY up to 50 indoor units



72
80

R2-Series H2i® Heat Recovery
PURY up to 48 indoor units



72
80

Y-Series Heat Pump
PUHY up to 50 indoor units



72
80

Y-Series H2i Heat Pump
PUHY up to 41 indoor units



72
80

WR2-Series Water-source Heat Recovery
PQRY up to 50 indoor units



72
80

WY-Series Water-source Heat Pump
PQHY up to 50 indoor units



72
80

S-Series Heat Pump
PUMY up to 12 indoor units



36 60
40 66

CAPACITY RANGE

HEATING **COOLING**

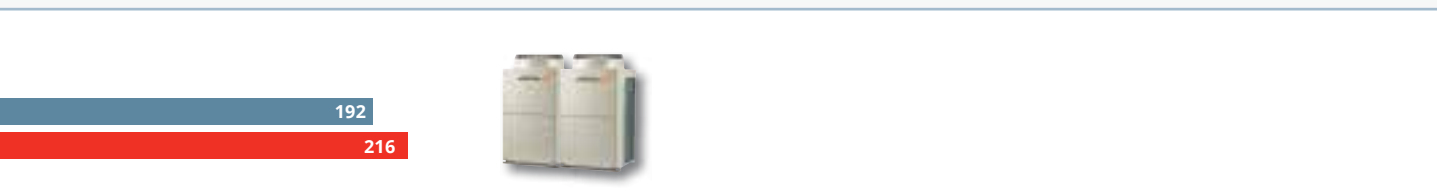
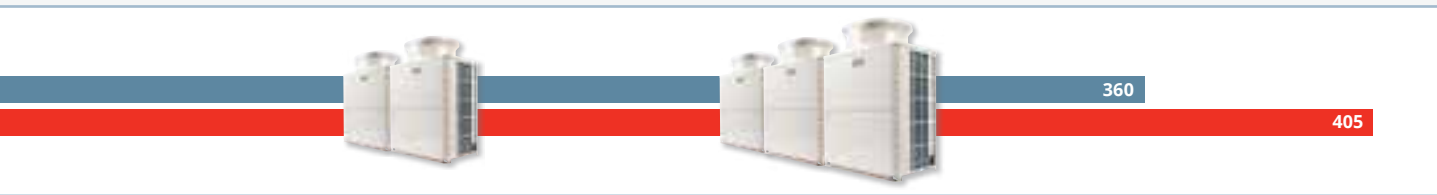
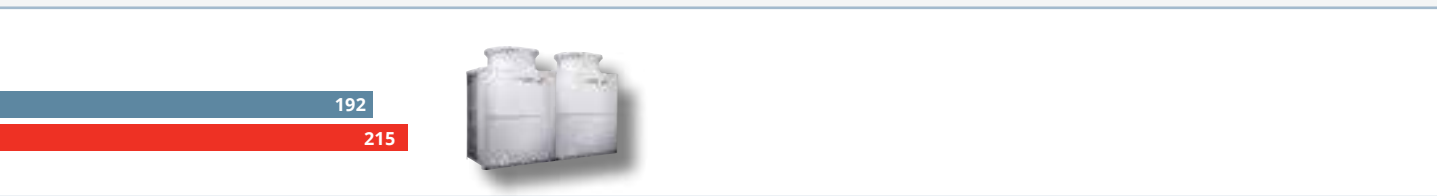
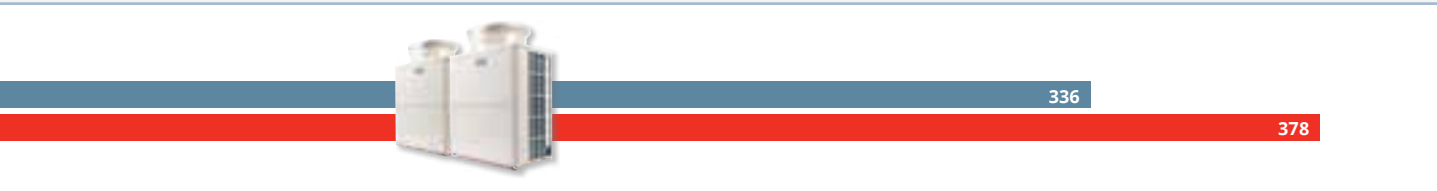
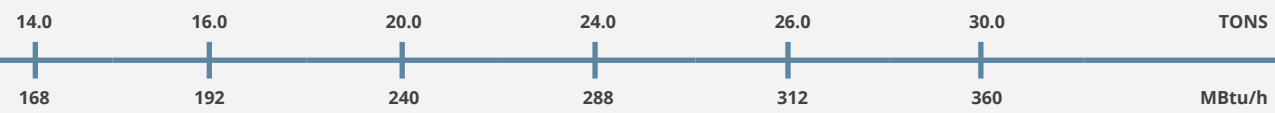

CITY MULTI OUTDOOR UNIT OPERATING RANGES

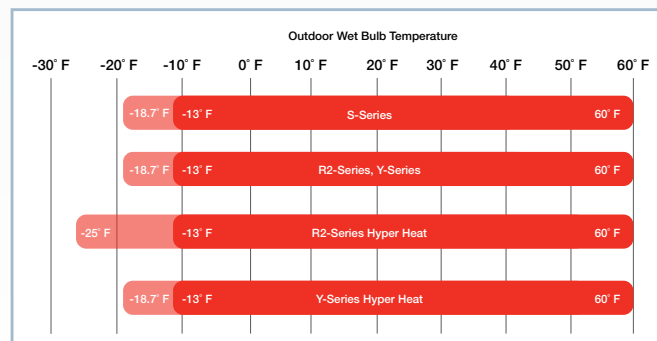
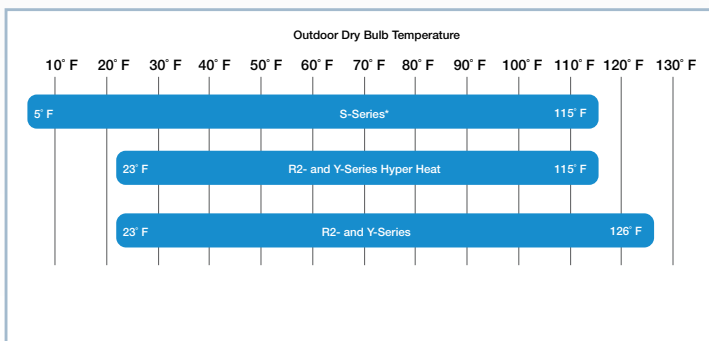

*Low ambient operation may require the use of low ambient accessories.



R2-SERIES

The R2-Series simultaneously cools and heats different zones within a building to provide energy saving heat recovery operation through the use of the Branch Circuit (BC) Controller.



KEY FEATURES: L-GENERATION

- ▶ Up to 54% increase in efficiency ratings vs. prior generations.
- ▶ Single modules up to 14 tons with the ability to combine modules for systems up to 28 tons.
- ▶ HexiCoil™ aluminum flat tube heat exchanger technology, eliminating copper tubing from the coil.
- ▶ Significantly less refrigerant charge required vs. prior generations.
- ▶ Supports up to 50 indoor units per system.
- ▶ Optimized refrigerant circuit and component design for improved flow distribution, allowing maximum energy transfer with minimal power input.
- ▶ Superior high-ambient cooling performance with guaranteed operation to 126°F.
- ▶ Extended 10-year parts and compressor warranty available.

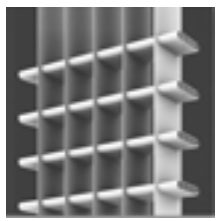

HEXICOIL™ CONDENSER COIL TECHNOLOGY

- ▶ Tubulated tube walls and optimized cross section ensure maximum heat transfer.
- ▶ Zinc coated for long-term corrosion resistance.
- ▶ Unique fin shape and coating provide water shedding capability.
- ▶ Capillary tube system leading to even fluid distribution.

Refrigerant Piping Lengths (Maximum Feet)	
Total Length¹	1,761–3,073
Farthest Indoor from Outdoor	541 (623 equivalent)
Maximum Length between Outdoor and Single/Main BC Controller	360
Maximum Length between Single/Main BC Controller & Indoor	131–197
Vertical Separation Between Components (Maximum Feet)	
Indoor/Outdoor (Outdoor Higher)³	164
Indoor/Outdoor (Outdoor Lower)⁴	131
Indoor/BC Controller (Single/Main)²	49
Indoor/Indoor	98
Main Controller/Sub BC Controller	49

1. Maximum Total Length is dependent on the outdoor unit model and distance between BC Controller.
 2. Maximum length between single/main BC Controller and indoor is dependent upon the vertical differential between the single/main BC Controller and the indoor unit.
 3. 295' is available depending on model and installation conditions. For more detailed information, contact your local sales office.
 4. 197' is available depending on model and installation conditions. For more detailed information, contact your local sales office.

SIMULTANEOUS OPERATION

CITY MULTI® VRF systems provide simultaneous cooling and heating any time of year. This innovation transfers heat from one zone, normally ejected outside the building, to be used in another zone within the building.

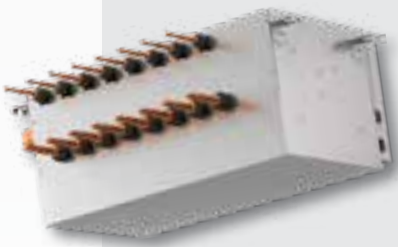
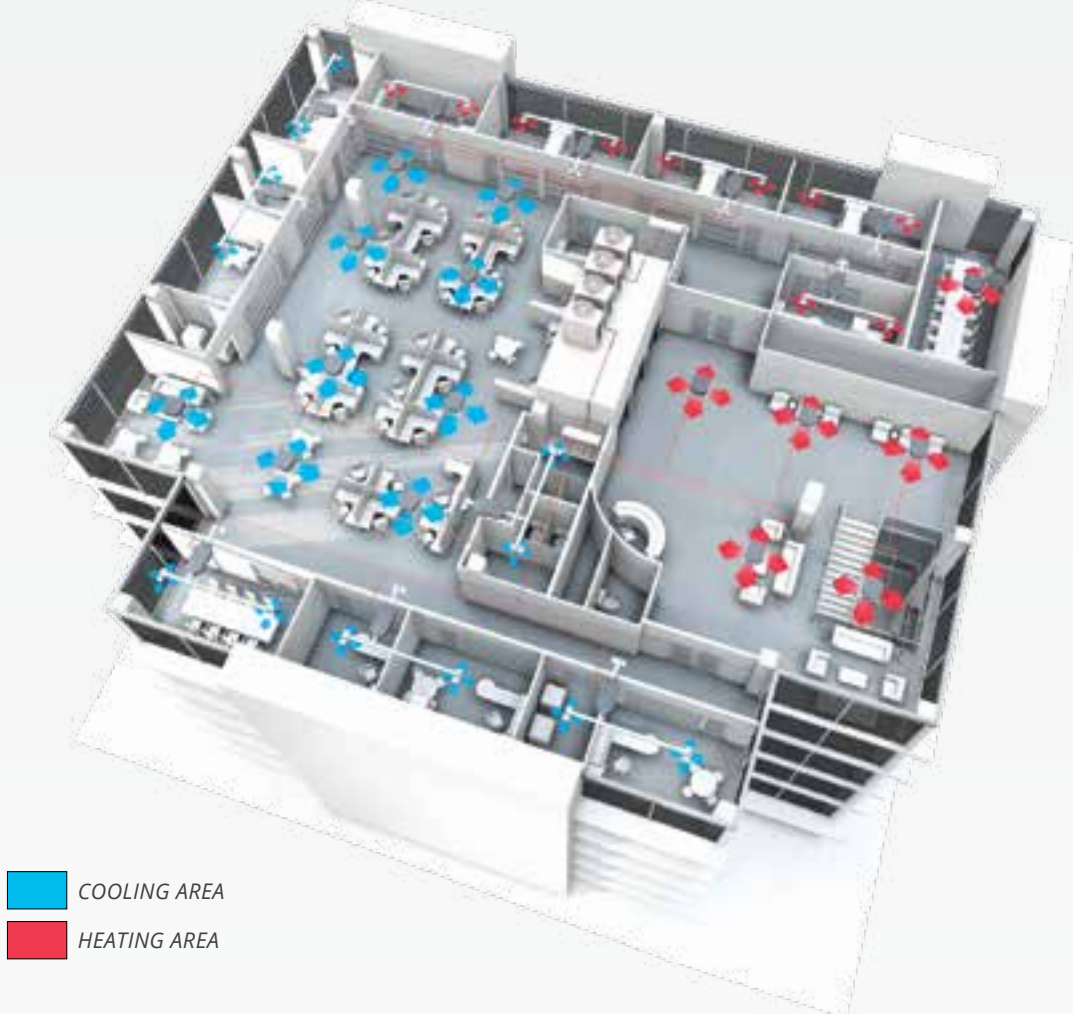

Branch Circuit Controller

The BC Controller is the technological heart of the CITY MULTI R2-Series. It works in unison with the outdoor unit to provide simultaneous cooling and heating, something no other two-pipe system can do.

Single BC Controller:

For systems with up to 120,000 Btu/h nominal cooling capacity that require only one BC Controller.

Main BC Controller:

For larger systems that require the use of Sub BC Controllers.

Sub BC Controller:

Used with a Main BC Controller to connect additional indoor units. A maximum of two Sub BC Controllers can be connected to one Main BC Controller per system.

THE TWO-PIPE ADVANTAGE

CITY MULTI heat recovery systems provide simultaneous cooling and heating with just two refrigerant pipes. As the number of indoor units grow, so do the two-pipe installations savings, in terms of connections (refrigerant and electrical) as well as maintenance access.

FEWER CONNECTIONS REQUIRED FOR SIMULTANEOUS OPERATION

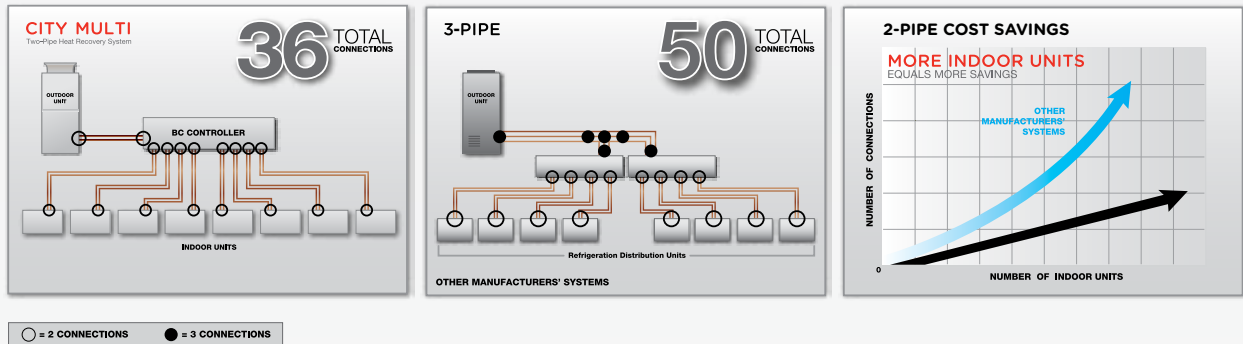

EFFECTIVE ENERGY USAGE

The total applied capacity of the R2-Series system's indoor units can be up to 150% of the capacity of the outdoor units. This is made possible by taking advantage of load diversity and simultaneous cooling and heating operation. CITY MULTI VRF systems can satisfy a significantly higher building load by efficiently distributing the capacity to the outdoor units and indoor units while using much less energy. CITY MULTI systems, in combination with our Integrated Centralized Control Web configured with optional Energy Allocation software, appropriately allocates the cooling and heating usage among the tenants. The allocation is based on each tenant's usage of comfort control based on the temperature setting on their system controller. Energy Allocation can control up to 2,000 indoor units from a single PC.

MODULAR SCALABILITY

With the Twinning Kit accessory, the modular units easily combine in the field to create a larger capacity system. Only two refrigerant pipes need to be twinned, saving time and materials. Oil and pressure equalization lines aren't needed when combining modules. This also helps to reduce installation cost.

SIMULTANEOUS OPERATING RANGE

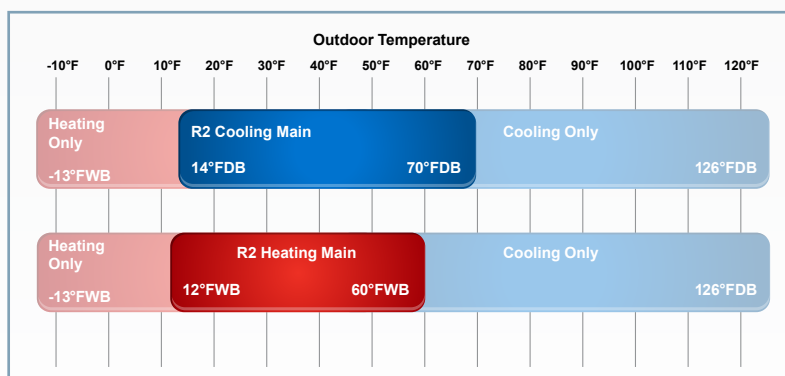

Y-SERIES

Two-pipe zoned heat pump system

Y-Series outdoor units are flexible enough to cool or heat up to 50 individual zones, maximizing building design options. The modular unit design features a small footprint and low operating sound.

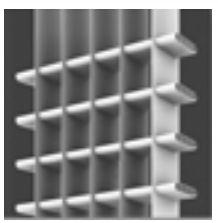

KEY FEATURES: L-GENERATION

- ▶ Up to 54% increase in efficiency ratings vs. prior generations.
- ▶ Single modules up to 14 tons with the ability to combine modules for systems up to 30 tons.
- ▶ HexiCoil™ aluminum flat tube heat exchanger technology, eliminating copper tubing from the coil.
- ▶ Significantly less refrigerant charge required vs. prior generations.
- ▶ Supports up to 50 indoor units per outdoor unit.
- ▶ Optimized refrigerant circuit and component design for improved flow distribution, allowing maximum energy transfer with minimal power input.
- ▶ Superior high-ambient cooling performance with guaranteed operation to 126° F.
- ▶ Extended 10-year parts and compressor warranty available.

HEXICOIL™ CONDENSER COIL TECHNOLOGY

- ▶ Tubulated tube walls and optimized cross section ensure maximum heat transfer.
- ▶ Zinc coated for long-term corrosion resistance.
- ▶ Unique fin shape and coating provide water shedding capability.
- ▶ Capillary tube system leading to even fluid distribution.

Maximum Refrigerant Piping Lengths (Feet)	
Total Length	3,280
Indoor to Outdoor	541
Indoor to First Branch	295
Vertical Differentials Between Units (Maximum Feet)	
Indoor/Outdoor (Outdoor Higher) ¹	164
Indoor/Outdoor (Outdoor Lower) ²	131
Indoor/Indoor	98

1. 295' is available depending on model and installation conditions. For more detailed information, contact your local sales office.
 2. 197' is available depending on model and installation conditions. For more detailed information, contact your local sales office.

*Benefits***ULTIMATE IN ZONING**

The CITY MULTI® Y-Series uses a two-pipe system with a wide variety of indoor units and individual zone controllers to provide the ultimate zoning system. Headers and T-branches simplify the piping design and provide design freedom for placement of both piping and indoor units. Individual zones are managed by remote controllers placed in each zone or by the centralized controller.

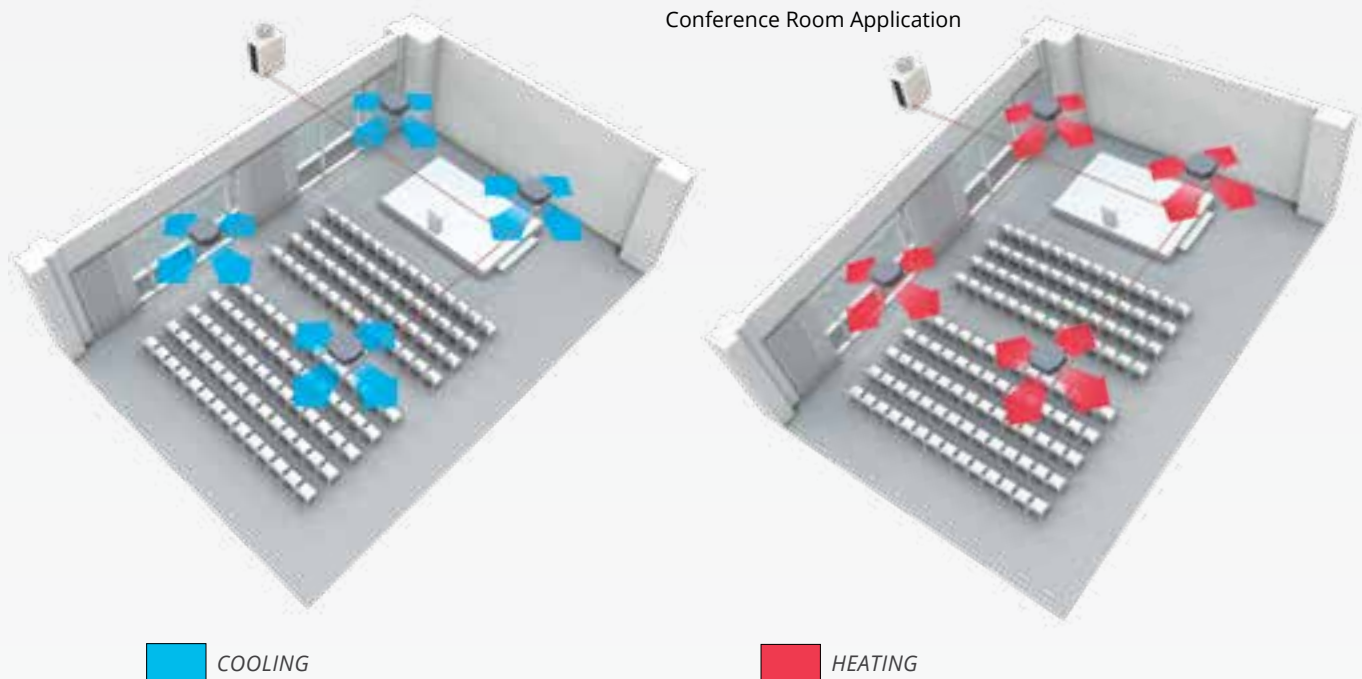
**INTELLIGENT ENERGY USAGE**

The highly responsive INVERTER technology and customized zone control of the CITY MULTI Y-Series provides year-round savings. In warm summer months, the Y-Series provides exceptional zoned cooling, and in cold winter months, the INVERTER-driven compressor provides outstanding heating performance. CITY MULTI systems, in combination with our Integrated Centralized Control Web configured with optional Energy Allocation software, appropriately allocates the cooling and heating usage among the tenants. The allocation is based on each tenant's usage of comfort control based on the temperature setting on their system controller. Energy Allocation can control up to 2,000 indoor units from a single PC.

DESIGN FLEXIBILITY

Flexibility is the key with the CITY MULTI Y-Series. The Y-Series, just like the R2-Series, can condition up to 50 zones. By using T-branches and headers, the Y-Series provides the ultimate in piping design flexibility that is truly simple in application.

H2i® R2-SERIES

Bringing year-round comfort to extreme climates with energy recovery

The Hyper-Heating INVERTER (H2i®) R2-Series simultaneously cools and heats different zones within a building to provide energy saving heat recovery operation. Our 2-pipe H2i® R2-Series gives you the flexibility to fit the specific needs of any building and provides reliable cold-climate heating performance.



KEY FEATURES

- ▶ 2-pipe, simultaneous operation for up to 48 zones.
- ▶ Available sizes: 6- , 8- , 12- , and 16-ton.
- ▶ 50%–150% connectable capacity.
- ▶ Extreme performance provides up to 100% heating output at 0° F and 83% heating capacity at -13° F.
- ▶ Simultaneous cooling and heating possible down to -5.8° F.
- ▶ Uses BC Controllers and headers to provide piping design flexibility and simultaneous operation.
- ▶ INVERTER-driven compressor for outstanding performance and optimized energy usage.
- ▶ Connects to CITY MULTI® indoor units; controlled via CITY MULTI Controls Network (CMCN).

Maximum Refrigerant Piping Lengths (Feet)	
Total Length <i>(Maximum Total Length is dependent on the outdoor unit model and distance between BC Controller)</i>	1,804–2,460
Farthest Indoor from Outdoor	541 (623 equivalent)
Maximum Length between Outdoor & Single/Main BC Controller	360
Maximum Length between Single/Main BC Controller and Indoor	131-197
Vertical Differentials Between Components (Maximum Feet)	
Indoor/Outdoor (Outdoor Higher)	164
Indoor/Outdoor (Outdoor Lower)	131
Indoor/BC Controller (Single/Main) <i>(Maximum length between single/main BC Controller and indoor is dependent upon the vertical differential between the single/main BC Controller and the indoor unit)</i>	49
Indoor/Indoor	49
Controller/Sub BC Controller	49

H2i® Y-SERIES

Bringing year-round comfort to extreme climates

Hyper-Heating INVERTER (H2i®) technology enhances the Y-Series by providing full heating capacity to -4° F outdoor ambient temperature. H2i® technology is exclusive to our products and is available in select CITY MULTI® VRF models.



KEY FEATURES

- ▶ Heat pump that provides either all-cool or all-heat operation in up to 41 zones.
- ▶ Available sizes: 6- , 8- , 12- , and 16-ton.
- ▶ 50%–130% connectable capacity.
- ▶ Extreme performance provides up to 100% heating output at -4° F and 85% heating capacity at -13° F.
- ▶ Uses T-branches and headers to provide piping design flexibility.
- ▶ INVERTER-driven compressor for outstanding performance and optimized energy usage.
- ▶ Connects to CITY MULTI® indoor units; controlled via CITY MULTI Controls Network (CMCN).

Maximum Refrigerant Piping Lengths (Feet)	
Total Length	984
Indoor to Outdoor	492
Indoor to First Branch	131
Vertical Differentials Between Units (Maximum Feet)	
Indoor/Outdoor (Outdoor Higher)	164
Indoor/Outdoor (Outdoor Lower)	131
Indoor/Indoor	49

EXTREME HEATING PERFORMANCE

With its expanded heating capabilities, the CITY MULTI® H2i R2- and Y-Series provides year-round comfort, even in extreme climates.

- ▶ At -13° F outdoor temperature, the H2i system can provide 100° F discharge air temperature from the indoor unit.
- ▶ At 5° F outdoor temperature and above, the discharge temperature reaches an impressive 110° F.
- ▶ At start-up, a special circuit assures that normally dormant refrigerant quickly enters the conditioning cycle. This process rapidly increases the mass flow rate in the system, which quickly provides comfortable discharge temperatures from the indoor units.

UNEQUALED COMFORT

The patented flash injection process cools the compressor, allowing higher speeds at a lower outdoor temperature without overheating. This also allows the system to maintain indoor coil temperatures providing phenomenal heating performance at low temperatures. The Hyper-Heating INVERTER combines the ultimate in application flexibility and powerful conditioning capabilities to deliver personalized comfort control to multiple zones of a commercial or institutional building. The outdoor units deliver full-sized performance from a compact, space-saving design for ease of transportation and installation. The INVERTER-driven scroll compressor delivers the precise amount of comfort to the zones as required.

HYPER-HEATING INVERTER VS. OTHERS

(72,000 Btu/h, 70° F W.B. entering Indoor Unit)

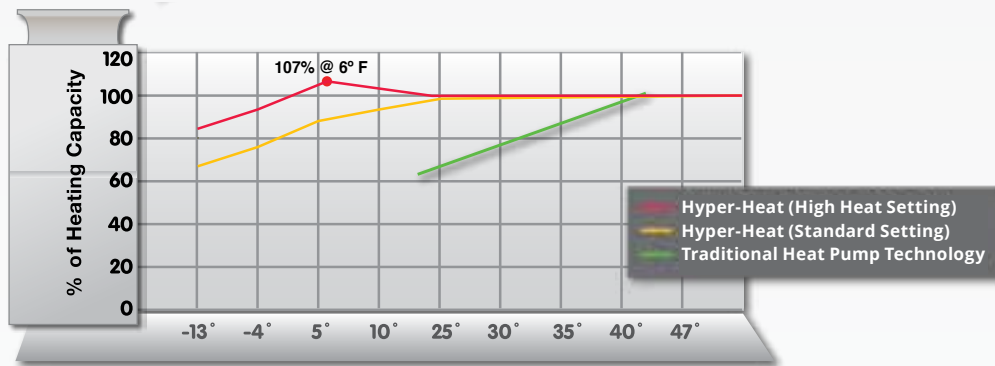

INDOOR UNIT HEATING DISCHARGE TEMPERATURE

(PEFY-P24 NMAU-E with 70° F Entering Air)

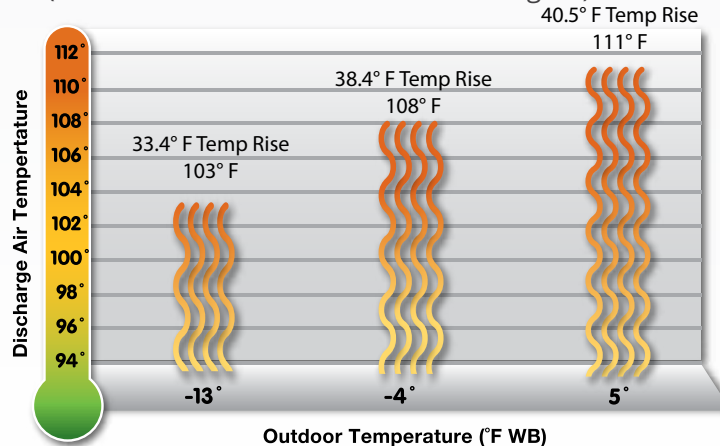

S-SERIES (PUMY)

Solutions for light commercial and large residential applications

The CITY MULTI® S-Series (PUMY) is a single-phase heat pump system ideal for light commercial or large residential applications. Featuring best-in-class efficiency ratings and ENERGY STAR® qualification, PUMY systems are designed to deliver operational cost savings and long-time performance to a homeowner or building owner. It uses the CITY MULTI Controls Network (CMCN) to cool or heat up to 12 individual zones with a choice of indoor unit styles.



KEY FEATURES

- ▶ Single phase 208/230V operation allows use in residential and light commercial applications.
- ▶ Systems available from 36,000–60,000 BTU/H.
- ▶ All models are Energy Star qualified.
- ▶ SEER rating improvement of 29% (*average vs. prior generation*).
- ▶ HSPF rating improvement of 27% (*average vs. prior generation*).
- ▶ Blue-fin condenser coating standard on all models.
- ▶ Extended heating operating range down to -13° F.
- ▶ Extended cooling operating range down to 5° F.
- ▶ Connects up to 12 indoor units.

*Low ambient operation requires the use of low ambient accessories such as a WB-PA3 Wind Baffle.

Maximum Refrigerant Piping Lengths (Feet)	
Total Length	984 ¹
Indoor to Outdoor	492 ²
Indoor to First Branch	98
Vertical Differentials Between Units (Maximum Feet)	
Indoor/Outdoor (Outdoor Higher)	164
Indoor/Outdoor (Outdoor Lower)	131
Indoor/Indoor	49

1. Applies to P36 and P48 models only. P60 is 492'.

2. Applies to P36 and P48 models only. P60 is 262'.

W-SERIES

Modular heat pump systems that combine the convenience of water source with VRF technology

W-Series units are easily installed indoors, which means that system performance efficiency is independent of outdoor ambient temperatures. W-Series includes WR2 models for simultaneous cooling and heating, and WY models for independent cooling and heating operation.



WY- and
WR2-Series

KEY FEATURES: L-GENERATION

- ▶ Single modules up to 20 tons with the ability to combine single modules for systems up to 30 tons.
- ▶ 208/230V, 3-Phase, 60 Hz and 460V, 3-Phase, 60 Hz options.
- ▶ 0-10V output signal to modulate water flow for compliance with energy codes.
- ▶ Enhanced water-side heat exchanger design for improved efficiency and reduced risk of clogging.
- ▶ Designed for closed water loops.
- ▶ Connects to CITY MULTI indoor units and controlled via CITY MULTI Controls Network (CMCN).
- ▶ Stack multiple units on a field-supplied rack to take advantage of vertical space when available.
- ▶ Extended 10-year parts and compressor warranty available.
- ▶ Unlike previous versions, water flow can be stopped while the unit is in a thermo-off state, saving on pump energy consumption. For twinned systems, both modules must be thermo-off to stop water flow.
- ▶ -A1 water-source units feature Variable Evaporating Temperature (VET) technology. This enables the condensing unit to raise the target evaporation temperature based on the difference between set point and return air temperature, saving energy.

Benefits

CITY MULTI SYSTEMS AND GEOTHERMAL APPLICATIONS

CITY MULTI water-cooled systems, used in geothermal and other types of applications, work by taking heat or rejecting heat from/to the ground. Closed loop systems accomplish this by circulating water through a series of wells or loops that are installed in the ground, turning the ground into a large heat exchanger. Because the ground remains relatively unaffected by outdoor ambient temperatures, the loop runs at temperatures lower than ambient temperatures throughout the cooling season and higher than ambient temperatures throughout the heating season.

Benefits

DOUBLE-HEAT RECOVERY

The double-heat recovery feature of the WR2-Series helps recover energy that would normally be rejected to the condensing water loop. First, within the system, energy is absorbed in units providing cooling. The energy is redirected by refrigerant to units that are in heating mode. Secondly, energy can be recovered between systems through the water loop.

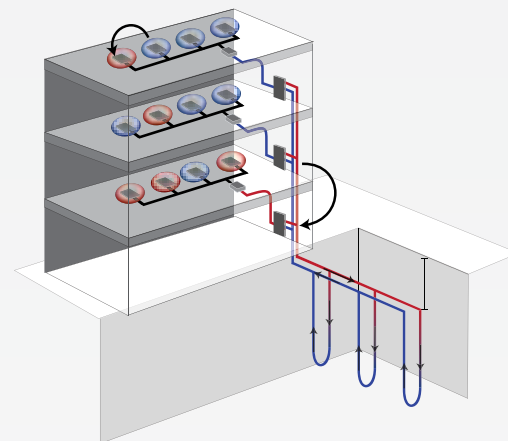
**EXTENDED TEMPERATURE RANGE**

WR2- and WY-Series CITY MULTI® water-source units can handle entering water temperatures down to 23° F (with the addition of glycol to the condenser water loop) in both heating and cooling mode allowing more possibilities for geothermal applications. Coupling the water-source units with a geothermal loop will not only provide the benefit of higher efficiencies by using a lower entering water temperature but will also provide all the benefit of an INVERTER-driven CITY MULTI system.

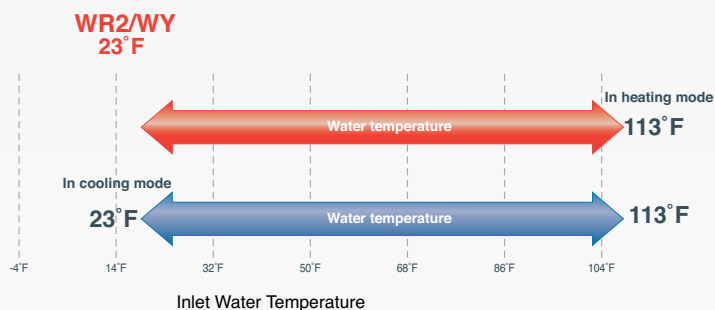
**VARIABLE EVAPORATING TEMPERATURE (VET)**

Variable Evaporating Temperature (VET) technology enables the condensing unit to raise the target evaporation temperature based on the difference between set point and return air temperature.

- ▶ Once all indoor units are within 1.8° F of set point, the target evaporating temperature will rise in a linear fashion the closer the indoor unit gets to set point.
- ▶ Four levels of VET are available (32° F, 37° F, 41° F and 43° F), offering energy efficiency improvements of 25%–45%.

ELECTRONIC PRESSURE INDEPENDENT VALVE (ePIV)

- ▶ The ePIV receives a 0–10V input signal from the condensing unit. This allows water flow to vary from nominal down to minimum, as demand is reduced.
- ▶ The valve eliminates power input penalties and capacity loss due to lower design flow at full load operation, while saving on pump energy at reduced load conditions.
- ▶ The valve contains a built-in ultrasonic flow meter with direct feedback into the valve actuator. This eliminates the balancing valve, along with labor to install it, for minimum and maximum flow and provides an integral flow switch function.

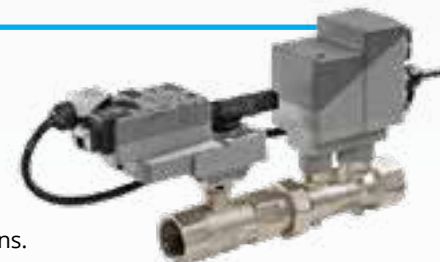

LOW AMBIENT COOLING KIT

Full cooling performance at extreme conditions

The specially designed wind deflectors will block unwanted wind that could impede operation and will allow full airflow when required at higher ambient temperatures or in heating mode. The assembly also provides a more efficient defrost cycle when the unit is operating in heating mode. Complete Low Ambient Kit requires hood with control damper assembly and wind deflectors.



PATENTED TECHNOLOGY

Low ambient hood (LAHK-1 and LAHK-2), Side Deflector (SWDK1), and Rear Deflector (RWDK1).

KEY FEATURES

Allows system to operate at 100% cooling capacity at reduced outdoor temperatures:

- ▶ Y-Series Outdoor Units (down to -10° FDB Outdoor Temp.)
- ▶ R2-Series (includes H2i® R2-Series) Outdoor Units (down to -10° FDB Outdoor Temp.)

ADDITIONAL FEATURES

- ▶ Hood and wind deflectors constructed of 20 gauge hot-dipped galvanized G-90 steel.
- ▶ Heavy-duty polyester-based powder paint finish.
- ▶ Designed to work with both 208/230 and 460V 3-phase units.
- ▶ NEMA 4X control box protects electrical components from the elements.
- ▶ Kit easily connects to outdoor unit with plug-in electrical connections.
- ▶ Wind deflectors easily install in place of existing wire guard.

APPLYING TO MULTIPLE OUTDOOR UNITS

For outdoor units with multiple modules, a minimum 1-3/16" separation between the modules is recommended. If modules are placed more than 15" apart, more than one set of side wind deflectors may be needed. For multiple units or module sets placed in a row, only one side wind deflector is needed for each of the outside module coil surfaces.

COLD WEATHER SOLUTIONS



Low Ambient Cooling (LAHK Series)

The specially designed wind deflectors block unwanted wind that could impede operation and allow full airflow when required at higher ambient temperatures or in heating mode. The wind deflectors also provide a more efficient defrost cycle when the unit is operating in heating mode. The complete Low Ambient Kit requires a hood with a control damper assembly and wind deflectors. With the addition of wind deflectors, CITY MULTI® Y-Series and R2-Series outdoor units feature 100% cooling capacity at outdoor temperatures down to -10° F. The wind deflector kit easily installs in the place of the existing wire guard, and the hood connects to the outdoor unit with plug-in electrical connections.



Hail/Snow Guards (SGK Series)

The hail/snow guards are designed to protect the outdoor unit coil surfaces from hail damage or snow buildup in severe climates. Made of 20-gauge, hot-dipped galvanized G-90 steel, the hail/snow guards feature a heavy-duty polyester-based powder paint finish to match the outdoor units. Using existing wire guard fasteners, the hail/snow guards are easily installed to the sides and rear of the unit in just minutes.

SGK-Series is compatible with K- and L-Generation.



Hail/Snow Hoods (SHK Series)

The hail/snow hoods are made to the same specifications as the hail/snow guards, and protect the outdoor unit fan guard from hail damage and snow buildup in severe climates. Using existing wire guard fasteners, the hail/snow hoods are easily installed to the sides and rear of the unit in just minutes. Hail/snow hoods are sold separately.

SHK-Series is compatible with K- and L-Generation.

Base Pan Heaters

Our base pan heaters feature a heating coil controlled by the CITY MULTI outdoor unit which prevents ice buildup. The base pan heater is ideal for low temperature, high humidity environments where the outdoor unit will be operating in heating mode for an extended period of time.

A complete base pan heater order should include a relay box, the heating element(s), required mounting brackets, and all other associated items required for installation.

Note: Snow hoods and side/rear snow guards are also recommended for installations with base pan heaters.



BASE PAN HEATER
CONTROL BOX

Supplemental Base Pan Heaters

Available for K & L-Generation Outdoor Units, Supplemental Base Pan Heaters provide additional heat to keep Base Pans clear of ice buildup in extreme weather conditions.



Cold weather stands and supports

We feature multiple configurations of stands and supports for M-Series, P-Series, and CITY MULTI outdoor units.

The sturdy stands and supports are designed to keep the outdoor unit above or off the ground and away from snow drifts in cold weather climates.

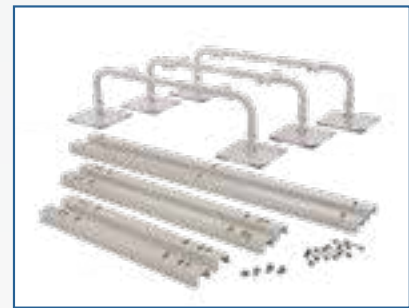

SuperStands

SuperStands provide secure mounting support and height above ground to keep CITY MULTI outdoor units out of normal snow accumulations. Available in 12", 18", and 24" leg heights for varying mounting options. The stands lock together to make one continuous interlocked stand for almost any number of outdoor units.

- ▶ Rubber roof friendly.
- ▶ Adjustable height in ¼" and ½" increments.
- ▶ U-Bars made from 11 gauge steel square tubing.
- ▶ Available leg heights: 12", 18", and 24".



Outdoor unit must be mounted at least 12" off the ground or 12" above the highest average snow depth, whichever is greater. The outdoor unit may require additional mounting restraints depending on the mounting location.

LINEAR EXPANSION VALVE (LEV) KIT

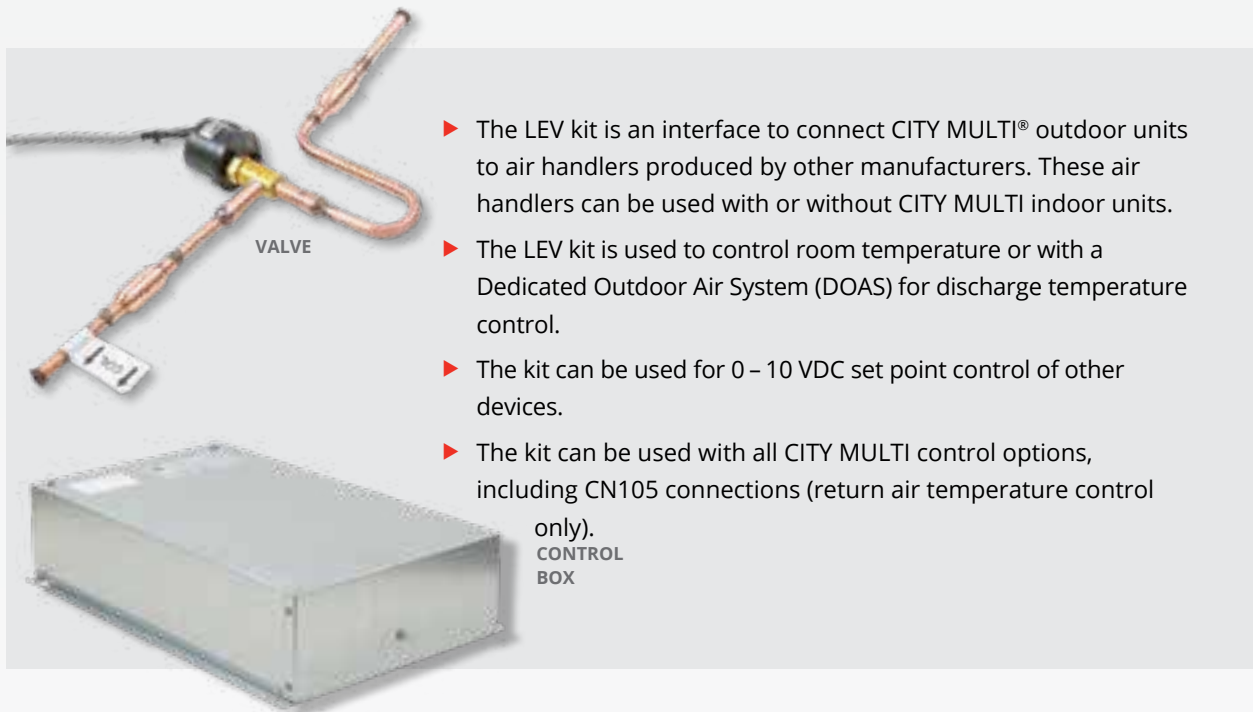

- ▶ The LEV kit is an interface to connect CITY MULTI® outdoor units to air handlers produced by other manufacturers. These air handlers can be used with or without CITY MULTI indoor units.
- ▶ The LEV kit is used to control room temperature or with a Dedicated Outdoor Air System (DOAS) for discharge temperature control.
- ▶ The kit can be used for 0 – 10 VDC set point control of other devices.
- ▶ The kit can be used with all CITY MULTI control options, including CN105 connections (return air temperature control only).

LEV Assembly Model*	Capacity Code Setting [Ton]	Design Capacity Range [Btu/h]
LEV PAC-LV24AC-1	0.5, 0.7, 1, 1.25, 1.5, 2	4,800–24,000
LEV PAC-LV48AC-1	2.25, 2.5, 3, 4	24,000–48,000
LEV PAC-LV60AC-1	4.5, 5	48,000–60,000
LEV PAC-LV96AC-1	6, 8	60,000–96,000
LEV PAC-LV120AC-1	10	96,000–120,000
LEV PAC-LV96AC-1 (x2)	12, 14, 16	120,000–192,000
LEV PAC-LV120AC-1 (x2)	18, 20	192,000–240,000

* Control box assembly required (PAC-AH001-1)

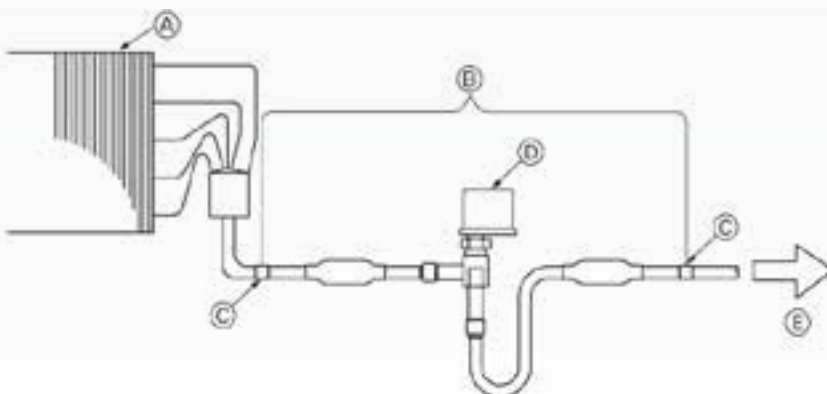

- Ⓐ AHU Heat Exchanger (field supplied)
- Ⓑ LEV Assembly
- Ⓒ Brazing
- Ⓓ LEV
- Ⓔ To Outdoor Unit





INDOOR UNITS

*PKFY Wall-mounted/PLFY Ceiling Cassette/PMFY Ceiling Cassette /
PCFY Ceiling-suspended/PEFY Ceiling-concealed Ducted /
PFFY Floor-standing/PVIFY Multi-position*



INDOOR UNITS

Complete Building Comfort Solutions

All models feature quiet operation, easy maintenance, and the ultimate in personalized comfort control. The chart below gives the capacity size for each model.

Capacity Code	Nominal Btu/h												
	6,000	8,000	12,000	15,000	18,000	24,000	27,000	30,000	36,000	48,000	54,000	72,000	96,000
Wall-mounted PKFY-P-N*MU-E 	•	•	•	•	•	•		•					
Ceiling Cassette (4-way) PLFY-P-NEMU 		•	•	•	•	•		•	•	•			
Ceiling Cassette (4-way) PLFY-P-NCMU 		•	•	•									
Ceiling Cassette (1-way) PMFY-P-NBMU 	•	•	•	•									
Ceiling-suspended PCFY-P-NKMU 				•		•		•	•				
Ceiling-concealed (Ducted Low-Profile) PEFY-P-NMSU 	•	•	•	•	•	•							
Ceiling-concealed (Ducted Medium-Static) PEFY-P-NMAU 	•	•	•	•	•	•	•	•	•	•	•		
Ceiling-concealed (Ducted High-Static) PEFY-P-NMHU/NMHSU 				•	•	•	•	•	•	•	•	•	•
Floor-standing (Exposed/ Concealed) PFFY-P-NEMU/NRMU 	•	•	•	•	•	•							
Multi-position PVFY-P-NAMU 			•		•	•		•	•	•	•		
PWFY-P-NMU-E2-AU PWFY-P-NMU-E-BU 									•			•	-AU only

PKFY (Wall-mounted)

Elegant design and compact dimensions

Whatever the size or shape of your room, there's a PKFY wall-mounted unit that is just right for you. PKFY units mount high on the wall and blend beautifully into any space. Perfect for hotels, assisted living facilities, offices, residences and other applications where wall space is available.



KEY FEATURES

- ▶ Ranges from 6,000 to 30,000 Btu/h.
- ▶ Compact, lightweight and features a built-in wireless sensor for use with an optional wireless remote controller.
- ▶ Extremely quiet: as low as 32 dB(A).
- ▶ Multiple fan speed settings.
- ▶ Multiple vane settings and swing setting adjust airflow in vertical directions.
- ▶ Front panel opens easily—no tools are needed to gain access to the filter.
- ▶ Refrigerant and drain piping can be connected from the rear, right, base, or left of the unit.
- ▶ Condensate Pump Systems are available when gravity drainage is not available.

Benefits

EASY FILTER CLEANING

The front grille hinges open easily—no tools are needed to gain quick access to the filter. The filter can be removed and cleaned as needed.

QUIET OPERATION

The unit incorporates a random-pitch fan to assure quiet operation. The optimal design of the airflow passage features a small fan diameter to allow for a compact installation. Thanks to practical casing configuration, airflow generated by the fan is uniformly distributed.

SUPERIOR AIR DISTRIBUTION

A user-selectable vane swing setting with the SmartME and SimpleMA remote controllers enhances air distribution in the conditioned space.

FLEXIBLE INSTALLATION

Refrigerant and drain piping can be connected from the rear, right, base, or left of the unit, providing much greater flexibility for piping and selecting an installation site.

PLFY (Four-way Ceiling Cassette)

Adjustable airflow to meet your every need

The PLY-Series four-way ceiling cassette provides exceptional performance and air coverage. Two styles are available: the PLY-P-NEMU and the PLY-P-NCMU. Both models can be accessorized with installation trim panels (PLY-ITP1 and PLY-ITP2) to ensure a seamless integration into suspended ceilings.



PLY-P-NEMU

KEY FEATURES

- ▶ 33" x 33" cabinet size.
- ▶ Capacity range of 8,000 to 48,000 Btu/h.
- ▶ Sound levels as low as 27 dB(A).
- ▶ Ventilation air connection (Second connection found in Multi-function Casement).
- ▶ High-efficiency filter option (MERV-10 requires Multi-function Casement).
- ▶ Branch ducting capability.
- ▶ Four-speed fan settings.
- ▶ Integrated condensate lift mechanism to provide up to 33-7/16" of lift.



PLY-P-NCMU

KEY FEATURES

- ▶ 22" x 22" cabinet size to fit in standard T-grid ceiling.
- ▶ Capacity range of 8,000 to 15,000 Btu/h.
- ▶ Sound levels as low as 29 dB(A).
- ▶ Ventilation air connection.
- ▶ Four-speed fan settings.
- ▶ Integrated condensate lift mechanism to provide up to 19-11/16" of lift.

Benefits

HIGH PERFORMANCE AND VERSATILITY

The four-way ceiling cassette is compact and recesses easily into a ceiling space, so all you see is an attractive flush-mounted grille. The PLFY-P-NEMU has a unit height of only 10-3/16" or 11-3/4", depending on the model. At 8-3/16" in height and 22-7/16" x 22-7/16" width, the PLFY-NCMU makes satisfying even the tightest of ceiling installations a possibility.

QUIET OPERATION

This powerful indoor unit is whisper-quiet, down to 27 dB(A) for the PLFY-P-NEMU and 29 dB(A) for the PLFY-NCMU.

CUSTOMIZE THE AIRFLOW PATTERN TO MEET YOUR NEEDS

The different airflow options provide the best solution for a variety of room layouts and air-conditioning requirements. For extra versatility, you can select up to 72 airflow patterns with two-, three-, or four-way airflow.

BUILT-IN CONDENSATE LIFT MECHANISM

The drain piping of the PLFY-P-NEMU can be positioned anywhere up to 33-7/16" from the ceiling's surface, allowing for long piping and versatility. The PLFY-NCMU model has a built-in pump that lifts condensate 20" from the ceiling's surface. The unit recognizes if there is a pump failure and safeguards against leaks.

CORNER-POCKET DESIGN SIMPLIFIES MAINTENANCE AND INSTALLATION

PLFY-P-NEMU allows access through the pockets equipped on each of four corners of the grille to complete installation, maintenance work, and height adjustment.

EASY MAINTENANCE, LONG-LIFE FILTER

The washable filter provides about 2,500 hours of use in a normal office environment before cleaning is needed.

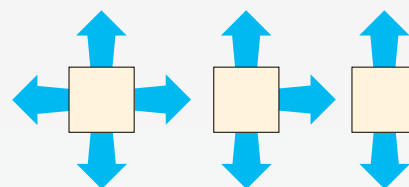
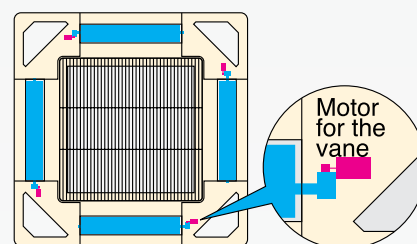
4-, 3-, OR 2-WAY AIRFLOW**FIXED AIRFLOW DIRECTION PER VANE****INDEPENDENT VANE MOTOR CONTROL**

The 3D i-see Sensor™ detects the number of occupants in a room and adjusts the temperature accordingly, making automatic energy-saving operation possible in places where the number of occupants frequently changes. Additionally, when the area is continuously unoccupied, the system switches to an enhanced power-saving mode.

- ▶ Detects occupant location
- ▶ Detects size, temperature, and movement of occupants (heat source). Once an occupant is detected, the angle of the indoor unit's vane(s) is automatically adjusted. Each vane can be independently set to "Direct Airflow" or "Indirect Airflow" according to user preference
- ▶ Highly accurate temperature detection
- ▶ The sensor can detect 1,856 points of surface temperature, rotating a full 360° in 3-minute intervals
 - This is a significant improvement over the previous version of the i-see Sensor, which had a single element and did not detect room occupants
- ▶ Room occupancy energy-saving mode
 - When the occupancy rate is approximately 30%, energy consumption is reduced by



offsetting the temperature by $\pm 2^{\circ}$ F

- ▶ No occupancy energy-saving mode
 - When the 3D i-see Sensor detects that no one is in the room, and 60 minutes have elapsed, the room temperature is offset by $\pm 4^{\circ}$ F
- ▶ No occupancy Auto-OFF mode
 - When the room remains unoccupied for a user specified period of time, the indoor unit turns off automatically, providing even greater energy savings. The time period can be set, in 10-minute intervals, from 60 to 180 minutes



PMFY (One-way Ceiling Cassette)

Compact and lightweight, perfect for office spaces with windows

The PMFY model is a ductless, one-way, ceiling cassette that moves air in one direction, and has the capability of introducing ventilation air. The PMFY can be accessorized with an installation trim panel (PMFY-ITP1) to ensure a seamless integration into suspended ceilings.



KEY FEATURES

- ▶ The PMFY is available in 6,000, 8,000, 12,000 and 15,000 Btu/h.
- ▶ Standardized cabinet size for all models: 31-31/32".
- ▶ Airflow control technology operates as low as 27 dB(A) for industry-leading quiet performance.
- ▶ Integrated condensate lift mechanism to provide up to 23-5/8" of lift.
- ▶ Full unit access through front cover panel.

Benefits

QUIET OPERATION

Specialized airflow control technology operates as low as 27 dB(A) for industry-leading sound performance.

BUILT-IN CONDENSATE LIFT MECHANISM

The drain pipe can be extended anywhere up to 23-5/8" above the ceiling's surface.

EASY INSTALLATION AND MAINTENANCE

PMFY body size has been standardized for all models at 31-31/32" for easier installation. With a height of only 9-1/16", the profile is one of the smallest of all CITY MULTI ceiling models. This unit is one of the lightest available with a weight of only 31 pounds for the main unit and seven pounds for the panel.

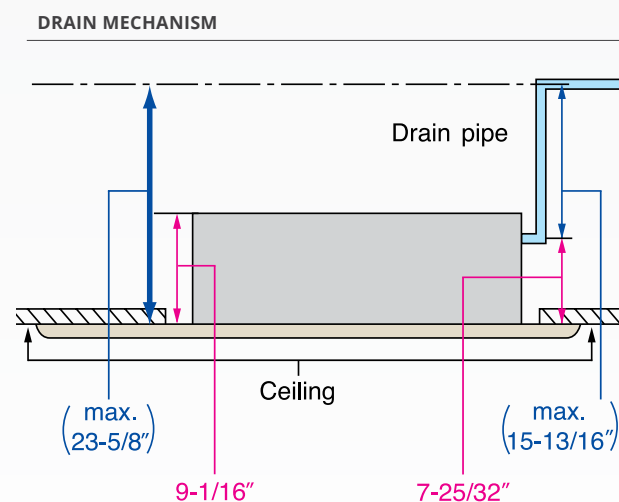

PCFY (Ceiling-suspended)

Compact design ideal for classrooms, restaurants and stores

The PCFY model features powerful air throw to cover entire spaces quietly and efficiently.



KEY FEATURES

- ▶ Available in 15,000, 24,000, 30,000, and 36,000 Btu/h capacities.
- ▶ Auto-vane and wide-range outlet provides uniformly distributed conditioned air to all corners of the room.
- ▶ Four-speed fan settings.
- ▶ Accessory filters are available to increase filtration effectiveness.
- ▶ Optional pump kit is available for condensate removal.

Benefits

POWERFUL PERFORMANCE

The easy-to-install, ceiling-suspended unit delivers enough cold or hot air to make any space more comfortable. Manually adjusted, oversized swing louvers direct the airflow left or right, covering the entire space quietly and efficiently.

3D I-SEE SENSOR™ ACCESSORY

This amazing technology constantly monitors and adjusts temperatures for maximum comfort and efficiency.

- ▶ Measures infrared rays generated from surrounding walls and surface angles.
- ▶ Rotates 90 degrees in five-second intervals.
- ▶ Efficiently adjusts temperatures to ideal comfort levels for occupants.

QUIET, EFFICIENT AIRFLOW

Appropriate airflow can be selected to enhance space conditioning efficiency and comfort while operating at a low sound level. PCFY's auto-vane and wide-range outlet swings the conditioned air and distributes it uniformly to all corners of the room.

EASY INSTALL

The PCFY's direct suspension allows installation on most ceiling surfaces quickly and securely using only suspension bolts and the durable attachment fixture. An optional pump kit is available to dispose of condensate.

PEFY (Ceiling-concealed Ducted)

Flexible design allows elegant interior layout

The PEFY models are high-performance, ceiling-concealed, ducted indoor units. An excellent choice for office buildings, schools, hotels, assisted-living facilities and other applications where ceiling space is available.

KEY FEATURES

- ▶ External static pressure settings are adjustable to meet varying application conditions.
- ▶ Choice of fan speed settings.
- ▶ Side access to control panel.
- ▶ Integrated condensate lift mechanism (low-static, mid-static and NMHU-E2 models).



LOW PROFILE (NMSU)

- ▶ Extremely quiet, with sound ratings as low as 26 dB(A).
- ▶ Capacities range from 6,000 to 24,000 Btu/h.
- ▶ Integrated condensate lift mechanism to provide up to 21-11/16" of lift.



MEDIUM STATIC (NMAU)

- ▶ Provides up to 0.60" external static pressure.
- ▶ Extremely quiet, with sound ratings as low as 26 dB(A).
- ▶ Capacities range from 6,000 to 54,000 Btu/h.
- ▶ Integrated condensate lift mechanism to provide up to 27-9/16" of lift.



HIGH STATIC (NMHU-E2/NMHSU)

- ▶ Provides up to 1.00" external static pressure.
- ▶ Extremely quiet, with sound ratings as low as 36 dB(A).
- ▶ Capacities range from 15,000 to 96,000 Btu/h.
- ▶ Integrated condensate lift mechanism to provide up to 27-9/16" of lift.
(Note: Not applicable to P72 and P96 models).

CHOICE OF EXTERNAL STATIC PRESSURE

Additional external static pressure capacity provides flexibility for duct extension, branching, and air outlet configuration. The factory setting can be field-adjusted to match the installed ductwork for PEFY indoor units. The PEFY indoor unit is available in a low-profile option with up to 0.20" W.G. and a high-static option for up to 1.00" W.G.

QUIET OPERATION

The specially designed centrifugal fan provides exceptionally quiet operation, even at high operating speeds.

OPERATING SOUND RANGE

		PEFY-P-NMAU	P06	P08	P12	P15	P18	P24	P27	P30	P36	P48	P54
Sound Level dB(A)	Fan Speed												
	Low-High		26-29		28-34		28-35	29-36		30-38		32-41	35-44

		PEFY-P-NMSU	P06	P08	P12	P15	P18	P24
Sound Level dB(A)	Fan Speed							
	Low-High		22-28	23-30	23-35	28-33	30-37	30-40

		PEFY-P-NMHS(U)	P15	P18	P24	P27	P30	P36	P48	P54	P72	P96
Sound Level dB(A)	Fan Speed											
	Low-High		34-39	36-41	35-41	38-43		38-44		36-43		39-46

BUILT-IN CONDENSATE LIFT MECHANISM

The drain piping can be positioned anywhere up to 21-11/16" for NMSU or 27-9/16" for NMAU and NMH(S)U. from the ceiling's surface, allowing for long piping and versatility. A built-in safety switch halts operation if the pump experiences a problem or the drain becomes clogged, ensuring no water leaks occur.

COMPACT OPTIONS (PEFY-P-NMSU)

The PEFY-P-NMSU-E model is very compact, with a height of 7-7/8". Standard features include brazed refrigerant connections, rear air return, and auto fan mode. The unit operates as low as 22 dB(A), and the control panel is located on the opposite side from other ducted models. This unit is an ideal choice for guest rooms in hotels, dormitories, assisted living centers or any application with tight vertical clearances and minimal duct work.

FB (M, L, H) FILTER BOXES

Designed for CITY MULTI® Ceiling-concealed Ducted Indoor Units

Low-Profile FBL1 boxes include 1"-thick pleated MERV 8 filter(s).

Medium-Static FBM2 boxes include 2"-thick pleated MERV 13 filter(s).

High-Static FBH4 boxes include 4"-thick pleated MERV 13 filter(s).



KEY FEATURES

- ▶ Rated Class 2 under UL Standard 900.
- ▶ Cabinet is constructed of non-insulated 20 gauge G-60 galvanized steel.
- ▶ Foam gasket provides airtight connection to indoor unit and access door.
- ▶ Return connection in rear easily field converted to bottom.

Part Number	Used on CITY MULTI Models	Filters Included	Net Weight (lbs.)
FBL1-1	PEFY-P06, P08, P12-NMSU	(1) — 13" x 25" x 1"	12
FBL1-2	PEFY-P15, P18-NMSU	(1) — 12" x 20" x 1" (1) — 12" x 14" x 1"	15
FBL1-3	PEFY-P24-NMSU	(3) — 12" x 20" x 1"	18

Part Number	Used on CITY MULTI Models	Filters Included	Net Weight (lbs.)
FBM2-1	PEFY-P06, P08, P12-NMAU	(1) — 14" x 25" x 2"	20
FBM2-2	PEFY-P15, P18-NMAU	(1) — 14" x 20" x 2" (1) — 14" x 14" x 2"	26
FBM2-3	PEFY-P24, P27, P30-NMAU	(2) — 14" x 20" x 2"	32
FBM2-4	PEFY-P36, P48-NMAU	(2) — 14" x 20" x 2" (1) — 14" x 14" x 2"	41
FBM2-5	PEFY-P54-NMAU	(3) — 14" x 20" x 2"	46

Part Number	Used on CITY MULTI Models	Filters Included	Net Weight (lbs.)
FBH2-1	PEFY-P15, P18, P24-NMHU	(1) — 20" x 24" x 2"	14
FBH2-2	PEFY-P27, P30-NMHU	(1) — 20" x 16" x 2", (1) — 20" x 20" x 2"	24
FBH2-3	PEFY-P36, P48, P54-NMHU	(2) — 20" x 20" x 2"	27
FBH4-4	PEFY-P72, P96NMHSU	(2) — 24" x 24" x 4"	40

PFFY (Floor-standing)

Effectively use perimeter areas for space conditioning

PFFY floor-standing models are available as exposed or concealed indoor units. At less than nine inches deep, these units are easy to install in peripheral spaces, yet offer highly efficient cooling and heating performance. Their low operating sound and compact size make them ideal for hotel rooms, schools and office buildings.



PFFY-P-NRMU
Concealed Type



PFFY-P-NEMU
Exposed Type

KEY FEATURES

- ▶ PFFY-NRMU—designed for applications requiring a built-in, concealed, floor-standing unit.
- ▶ PFFY-NEMU—exposed-type model, perfect for most applications and requires no finish work.
- ▶ Available in 6,000, 8,000, 12,000, 15,000, 18,000 and 24,000 Btu/h.
- ▶ Two-speed fan settings.
- ▶ The PFFY-P-NRMU unit can be field converted from top discharge to front discharge.

Benefits

OPTIONAL MOUNTING FOR REMOTE CONTROLLER

PFFY units can house a remote controller in the top corner (under a cover panel). The remote controller can be mounted on the wall or in the PFFY unit.

INSTALLATION FLEXIBILITY

The PFFY-P-NRMU-E unit can be field converted from top discharge to front discharge to increase installation flexibility.

INSTALLATION FLEXIBILITY

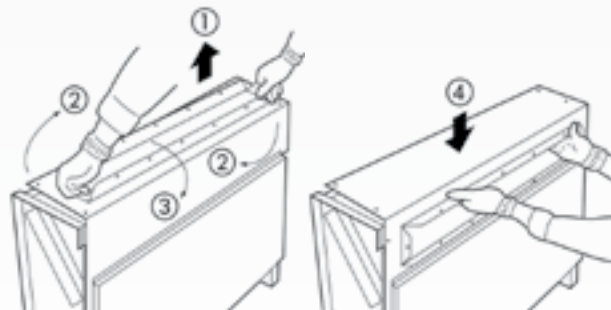

PVFY (Multi-position Air Handler)

Ideal for closet, attic, or equipment room installations

PVFY multi-position air handlers can be connected to a system with other CITY MULTI® indoor units for complete system design flexibility. The multi-position design is suitable for any application, making it ideal for installation in a closet, attic, or an equipment room.



Capacity Range:
12,000–54,000 Btu/h

KEY FEATURES

- ▶ Selectable external static pressure up to 0.80.
- ▶ Reusable standard-size 1" filter.
- ▶ Side return available (P12-P24 only).
- ▶ Unique cabinet insulation design allows for no thermal penetration into the coil section.
- ▶ Cabinet can be disassembled to install in very tight spaces.
- ▶ Heavy gauge, high-gloss powder coat finish steel cabinets with 1" fiberglass-free foam insulation (R-4.2 insulation value).
- ▶ Accessories available for various custom applications, including two-stage auxiliary heat, fan speed indication, humidifier control, and more.
- ▶ Cabinet sections are embossed with fan, coil, and other components for easy identification and maintenance.

VERTICAL AIRFLOW

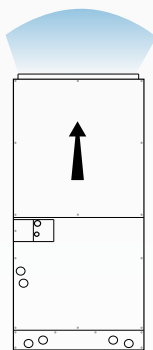

HORIZONTAL LEFT AIRFLOW

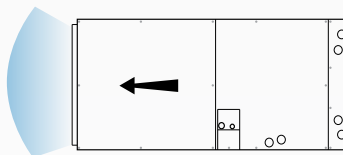

HORIZONTAL RIGHT AIRFLOW

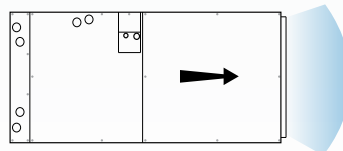

DOWNFLOW

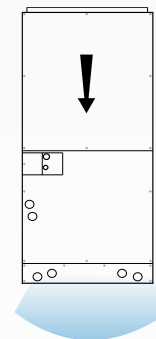

For downflow configurations, the CMA-1 is recommended for proper management of condensate to prevent water blowoff in certain conditions.

PWFY (Hydronic Heat Exchanger)

Heat and cool water, quickly and efficiently

The PWFY Hydronic Heat Exchanger is available in two configurations, the HEX (-AU) and the Booster (-BU). Each provides unique solutions to incorporate into an existing VRF system for an efficient means to heat and cool non potable water. The PWFY is a closed-circuit water heater that works with the Y-Series or R2-Series outdoor units.



Available Sizes:
36,000 and 72,000 Btu/h

PWFY-P36/72NMU-E2-AU

KEY FEATURES

- ▶ Heats water to 113° F.
- ▶ Hydronic heat exchanger transfers energy from refrigerant to water.
- ▶ Can be used to recover waste heat from cooling operation to water when combined with any R2-Series, resulting in large energy savings.
- ▶ Cools water to 41° F to be used for cooling outside air, cooling pool water, misting stations, process cooling and more.
- ▶ Applications include radiant heating, snow melting, reheating air, pre-heating hot water and more.



Available Sizes:
36,000 Btu/h

PWFY-P36NMU-E-BU

KEY FEATURES

- ▶ Heats water to 160° F.
- ▶ Hydronic heat exchanger transfers energy from refrigerant to water.
- ▶ Compatible with R2- and WR2-Series.
- ▶ Can be used to recover waste heat from cooling operation to water, resulting in large energy savings.
- ▶ Includes R134A compressor circuit for boosting water temperature.
- ▶ Applications include radiant heating, hot water preheating, snow melting, reheating air, warming pools, and more.



VENTILATION

Lossnay[®] Energy Recovery Ventilators (ERVs)/DOAS

LOSSNAY® ENERGY RECOVERY VENTILATORS (ERVs)

Outdoor air solutions for improved indoor environmental quality



KEY FEATURES

- ▶ Lossnay core.
- ▶ Over 50% enthalpy exchange efficiency.
- ▶ Four fan speeds on 300, 470, 600 models: extra low, low, high, extra high.
- ▶ M-NET connectivity for use with CITY MULTI® central controllers and BMS interfaces.
- ▶ Sound pressure level: maximum sound level 40.5 dB(A).
- ▶ Three ventilation modes: Auto, Bypass, Heat Recovery.

Benefits

INTERLOCK

Networking systems has never been easier. The M-NET adapter comes standard, and there is no need to purchase additional parts. Systems can be assembled simply and logically, reducing construction time and keeping initial costs low.

SYSTEM COMPATIBILITY

The LGH-F-RX5 series is fully compatible with our controls network, further increasing the scope of total system management.

MULTI-FUNCTION LCD REMOTE CONTROLLER

The compact and attractive remote controller with a liquid crystal display is designed for easy visibility.

- ▶ ON/OFF, Run mode, and Ventilation mode
- ▶ Filter Maintenance Display
- ▶ Controls up to 16 Lossnay units in a single group
- ▶ Night Purge
- ▶ Timer Operations

BYPASS VENTILATION STANDARD

Lossnay models offer three ventilation modes:

- ▶ Energy Recovery—Heat Exchange
- ▶ Bypass—No Exchange
- ▶ Automatic—Heat Exchange/Bypass

With conventional ERVs, bypass ventilation was impossible without attaching additional dampers and adapters. With the LGH-F-RX5 series, however, this mode is available without the use of other parts. An automatic mode allows the system to select recovery or bypass as required. Mode selection is easy when interlocked with M-NET systems using the PZ-60DR remote controller, which is sold separately.



PZ-43SMF



PZ-60DR

DEDICATED OUTDOOR AIR SYSTEM (DOAS)

Provides pre-conditioned outdoor air

The award-winning PEFY-AF Dedicated Outside Air System comes in two configurations, the CFM and the CFMR. Both configurations offer high capacity coils that will condition incoming air, making it suitable for distribution to downstream fan coil units.

KEY FEATURES

- ▶ Single-speed 1200 CFM fan.
- ▶ Multiple external static pressure set points.
- ▶ Large DX coil with high latent capacity.
- ▶ Entering air temperature and humidity sensors factory installed.
- ▶ Thin 18-9/16" high cabinet installs in small areas.
- ▶ Drain lift mechanism up to 21-11/16" included as standard.
- ▶ 50° F to 70° F saturated air available in cooling mode (CFM/PUHY-P120).
- ▶ Reheat capabilities using recovered energy from cooling through the branch controller (CFMR/PURY-P120).
- ▶ 50° F to 60° F saturated air available leaving cooling coil (CFMR/PURY-P120).
- ▶ 63° F to 83° F leaving air temperature available leaving reheat coil (CFMR/PURY-P120).

CFM

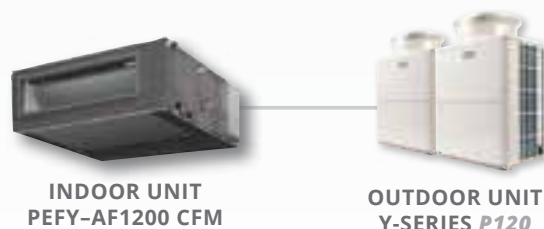

CFMR

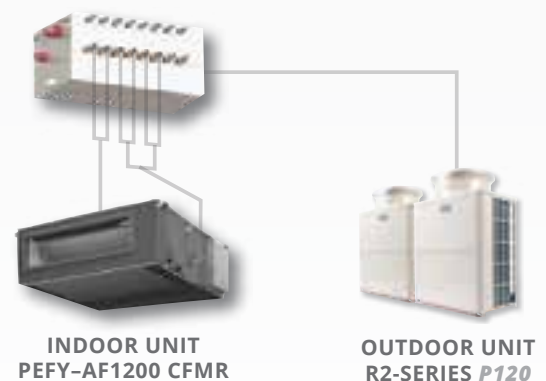



CONTROLS AND SOFTWARE SOLUTIONS



CONTROLS NETWORK

Our CITY MULTI® Controls Network (CMCN) makes it easy to manage your building.

The Integrated Centralized Control Web (ICCW) manages up to 2,000 indoor units from a single networked PC or tablet. The ICCW puts individual, personalized comfort in the hands of the tenants and the building manager.



Benefits

FLEXIBLE DESIGN FOR CUSTOMIZED, INDIVIDUAL ZONE CONTROL

Building owners and engineers can select from a wide variety of remote controllers and other devices to satisfy the exact level of tenant control on a zone-by-zone basis, while providing the ultimate in personal comfort control. The versatility of the CMCN enables each building's controls network to address the specific design and tenant requirements, while providing unparalleled occupant comfort.

OPTIONAL EASY-TO-USE CONTROL VIA PC WEB BROWSER

From a web browser on a PC or tablet, the building manager can now monitor, operate and schedule the HVAC system through the central controller. Plus, the building manager can enable tenants to control their own individual zones via a personal web browser on their networked PC, tablet, or smartphone.

EASY INSTALLATION

The CMCN uses simple, non-polar, two-wire control connections. All components are daisy chained and added onto the M-NET communication bus. It all adds up to less labor and materials with quicker installation.

SINGLE-SOURCE CONTROL FOR UP TO 2,000 INDOOR UNITS

You can control up to 2,000 units with central controllers, empowering the building manager to control the HVAC system for multiple buildings in a business park, educational campus or retirement facility.

ENERGY ALLOCATION

A centralized controller network configured with the energy allocation option and watt-hour meter(s) can calculate the HVAC energy consumption relative to each indoor unit on a per-tenant basis and generate a CITY MULTI energy allocation per tenant. The Energy Allocation feature is available through the AE-200A/AE-50A/EW-50A centralized controllers.

SYSTEM INTEGRATION

Not only can our CMCN act as a standalone building management system, it can also integrate with existing systems via LonWorks® or BACnet®.

INTEGRATED CENTRALIZED CONTROL WEB

The Integrated Centralized Control Web (ICCW) enables the user to control multiple AE-200A/ AE-50A /EW-50A centralized controllers and provide enhanced functions from any networked PC, tablet or smart phone. ICCW is capable of controlling up to 2,000 indoor units in conjunction with our centralized controllers.



ENERGY ALLOCATION

KEY FEATURES

- ▶ Allocates the energy cost of the outdoor unit(s) power consumption to building tenants based on the capacity used by their indoor units.
- ▶ Great for condos and multiple tenant spaces.
- ▶ Requires a software license (SW-Charge).

TABLET

FLOOR PLAN:



SCHEDULE:



ALL GROUPS:



HOME SCREEN (TABLET):



SMART PHONE



Note: requires a license (SW-PWeb)

LICENSE OPTIONS FOR CENTRALIZED CONTROLLERS

Centralized controllers support operations that supercede simple control of the HVAC system and include system configuration, scheduling, batch operation, and malfunction monitoring through license options. These license options further expand the functionality of our centralized controller offerings.

OPTIONAL LICENSES

PERSONAL WEB BROWSER (SW-PWEB)

Allows facility managers individual users to control their zone conditioning via personal networked PC, tablet or smart phone with or without remote controllers. Personal web browser is only supported on AE-200A, AE-50A, and EW-50A centralized controllers.

BACnet TCP/IP COMMUNICATION (SW-BACNET)

Allows for BACnet TCP/IP communication from a centralized controller to third-party building management software via an Ethernet connection. The BACnet license is only supported on the AE-200A, AE-50A, and EW-50A centralized controllers.

ENERGY ALLOCATION (SW-CHARGE)

Provides the ability for the AE-200A to allocate the outdoor unit(s) power consumption to building tenants based on the capacity used by their indoor units. Note that there are additional components required to complete a full Energy Allocation installation.

	Part Number	Description	AE-200A	AE-50A	EW-50A
OPTIONAL LICENSES	SW-Charge	Energy Allocation	•	•	•
	SW-Pweb	Personal Web Browser	•	•	•
	SW-BACnet	BACnet(R) TCP/IP communication	•	•	•
OPTIONAL ACCESSORIES	PAC-YG84UTB-J	Electric Box	•	•	
	PAC-YG86TK-J	Mounting Kit (for control panel)	•	•	
	PAC-YG82TB-J	Mounting Attachment (for wall surface)	•	•	
	PAC-YG72CWL-J	Surface cover with USB port	•	•	



PAC-YG82TB-J



PAC-YG84UTB-J



PAC-YG86TK-J



PAC-YG72CWL-J

CENTRALIZED CONTROLLER AE-200A/AE-50A

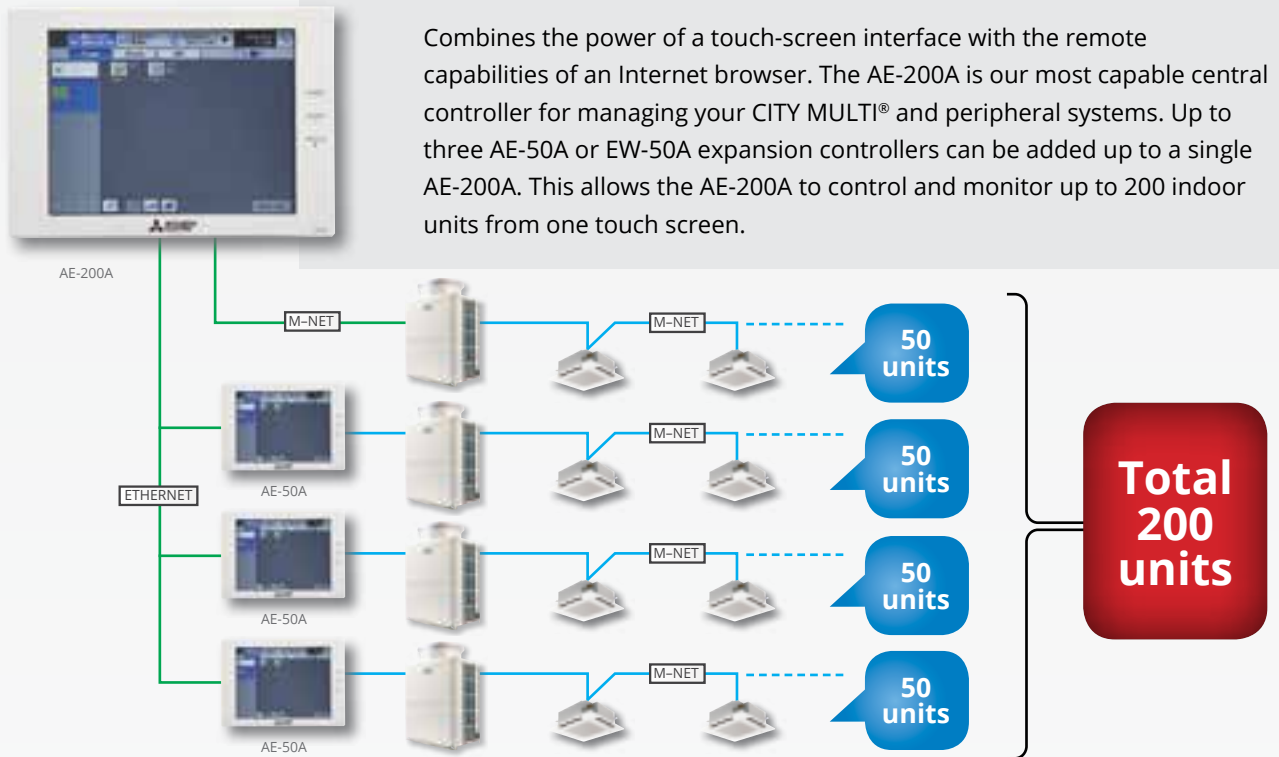

Combines the power of a touch-screen interface with the remote capabilities of an Internet browser. The AE-200A is our most capable central controller for managing your CITY MULTI® and peripheral systems. Up to three AE-50A or EW-50A expansion controllers can be added up to a single AE-200A. This allows the AE-200A to control and monitor up to 200 indoor units from one touch screen.

PROVIDE ASSISTANCE IN IDENTIFYING ENERGY SAVINGS BY COMPREHENSIVELY SHOWING THE ENERGY CONSUMPTION OF HVAC EQUIPMENT

Energy consumption of HVAC equipment by individual area is displayed graphically on the controller's interface. This enables comparisons with the previous year's power consumption as well as provides a view to performance against electric usage targets. Floor layout is displayed on the 10.4" LCD touch panel which facilitates easier operation of HVAC equipment.

ESTABLISH THE OPTIMAL SYSTEM BASED ON THE SCALE OF YOUR FACILITY

The AE-200A allows a user to control up to 50 indoor units. The AE-200A can increase its control capabilities to a maximum of 200 indoor units with the addition of three AE-50A expansion controllers. A PC or tablet connection enables the control of more than 200 indoor units via the ICCW browser.

DUAL SET POINT

When the operation mode is set to Auto (dual set point), two preset temperatures can be set. Depending on the room temperature, the indoor unit will automatically operate in either the Cool or Heat mode to keep the room temperature within the preset range.

MONITOR AND OPERATE THE HOT WATER HEAT PUMP THROUGH THE ADDITION OF A PWFY

Centralized batch control with the PWFY is made possible through the use of an AE-200A/AE-50A.

CENTRALIZED CONTROLLER AE-200A/AE-50A



The AE-50A centralized controller can only expand an AE-200A controller, it cannot be used by itself. Three AE-50A controllers can expand an AE-200A to monitor 200 indoor units. It features advanced functionality with expanded monitoring, control, dual set point and trending abilities.

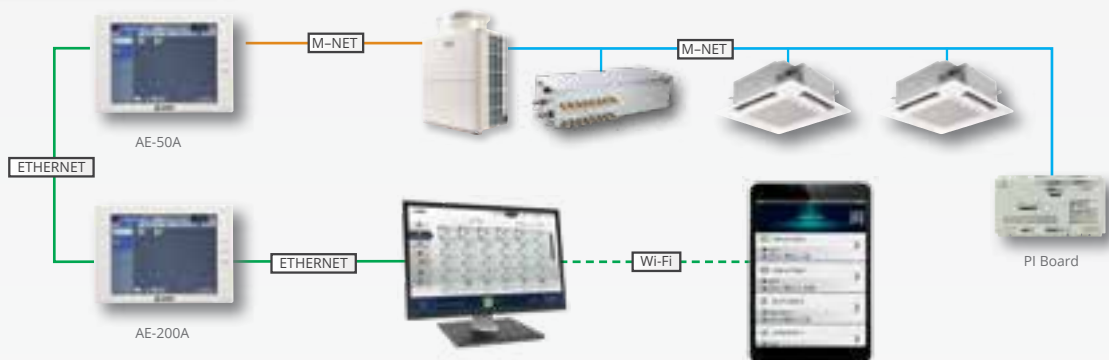

CONTROL SCREEN FOR POWER CONSUMPTION

Energy consumption of an applicable area can be displayed by the month, day, and/or hour. Energy consumption of two different units, groups and block, can be compared within the software. The energy consumption of the fan(s), along with operation time, can be displayed as well.

Energy consumption of the HVAC equipment is ranked and displayed by each unique area, thus visualizing high-load components within the system. In addition, a comparison of energy consumption alongside target electric energy usage is possible.

STANDARD FEATURES

Function	Description
Touch Screen	10.4" high resolution color touch screen
Max No. of Indoor Units	Up to 200 indoor units can be controlled and monitored when three expansion controllers (AE-50A and/or EW-50A) are networked together.
ON/OFF	On/Off operation for a single group and batch operation
Operation Mode	Setback/Cool/Dry/Auto (R2- and WR2-Series)/Fan/Heat
Temperature Setting	Supports single and dual set point operation with extended set temperature range
Fan Speed Setting	Hi/Mid-2/Mid-1 /Low/Auto (Available fan speed settings depending on indoor unit)
Airflow Direction Setting	Swing/Horizontal/Mid-0/Mid-1/Mid-2/Mid-3/Auto (settings vary depending on indoor unit model)
Permit/Prohibit Function	Individual prohibit operations for each remote controller function (ON/OFF, Set Temperature, Operation Mode and Filter Reset)
Indoor Return Air Temperature	Displays the measured return air temperature from each group
Error Indication	Displays a four-digit code and the affected unit address
Test Run Function	Allows indoor units to operate in test mode
Ventilation Interlock	Allows the group to be interlocked with Lossnay unit
Schedule Operation	Annual, Weekly, and Today schedules
External Input/Output	Inputs: Level Signal — Batch Start/Stop, Batch Emergency Stop Outputs: Start/Stop Status, Error/Normal Status
Power Supply	Built-in
Dimensions — (H x W x D)	7-27/32" x 11-5/32" x 2-17/32"

CENTRALIZED CONTROLLER EW-50A



The EW-50A centralized controller is a web browser-only centralized controller for managing CITY MULTI® and peripheral systems. The EW-50A can also connect to an AE-200A over Ethernet to expand its monitoring capability to up to 200 indoor units when three EW-50A units are used. The EW-50A features advanced functionality with expanded monitoring, control, dual set point and trending abilities.

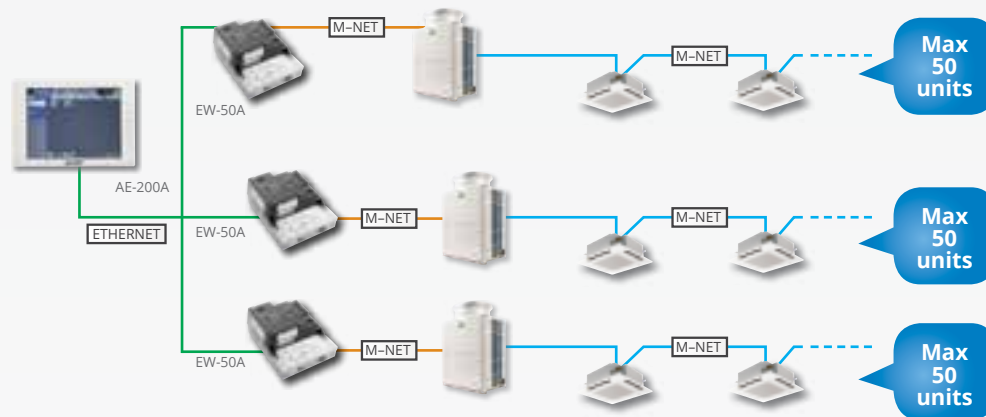

STANDARD FEATURES

FUNCTION	DESCRIPTION
Max No. of Indoor Units	Up to 50 indoor units can be controlled and monitored
ON/OFF	On/Off operation for a single group and batch operation
Operation Mode	Setback /Cool/Dry/Auto (R2- and WR2-Series)/Fan/Heat
Function	Hold (temporarily disables schedules)/Initial setting/Operation data back-up
Displays	CITY MULTI compressor speed and hi/low pressure/AdvancedHVAC Controller (DC-AIO) input/output status/Space temperature and humidity (from SmartME or AI controller)/Error code (four-digit code and the affected unit address)/Unoccupied setback temperature range/Occupancy and brightness status from the SmartME remote controller
Temperature Setting	Supports single and dual set point operation with extended set temperature range
Fan Speed Setting	Hi/Mid-2/Mid-1/Low/Auto (Available fan speed settings depending on indoor unit)
Airflow Direction Setting	Swing/Horizontal/Mid-0/Mid-1/Mid-2/Mid-3/Auto (settings vary depending on indoor unit model)
Permit/Prohibit Function	Individual prohibit operations for each remote controller function include ON/OFF/Set Temperature/Fan speed and direction/Operation Mode/Filter Reset
Ventilation Interlock	Allows the group to be interlocked with Lossnay unit
Schedule Operation	Annual, Today, and Weekly schedules
External Input/Output	Inputs: Level Signal-Batch Start/Stop, Batch Emergency Stop Outputs: Start/Stop Status, Error/Normal Status (requires PAC-YG10HA)
Trending Data	Fan operation time/Thermo-on time/Set temperature/Room temperature/AI controller temperature and humidity
Power Supply	Built-in
Dimensions - (H x W x D)	8-4/16" x 6-13/16" x 3-10/16"

CENTRALIZED CONTROLLER TC-24B



Customized individual zone control via a bright and easy-to-use touchscreen interface. The TC-24B is perfect for light commercial and residential applications.

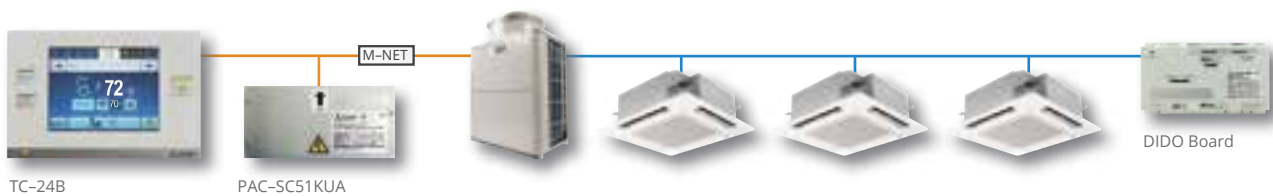

STANDARD FEATURES

Function	Description
Max No. of Indoor Units	Up to 24 indoor units can be connected
ON/OFF	On/Off operation for a single group and batch operation
Operation Mode	Setback /Cool/Dry/Auto (R2- and WR2-Series)/Fan/Heat
Temperature Setting	Supports single and dual set point modes/Set temperature from 57° F – 87° F depending on operation mode and indoor unit
Fan Speed Setting	Hi/Mid-2/Mid-1 /Low/Auto (Available fan speed settings depending on indoor unit)
Airflow Direction Setting	Airflow angles: 100° – 80° – 60° – 40° and swing/Airflow direction settings vary depending on indoor unit model
Permit/Prohibit Function	Individual prohibit operations for each remote controller function (ON/OFF, Set Temperature, Operation Mode and Filter Reset)
Indoor Return Air Temperature	Displays the measured return air temperature from each group
Error Indication	Displays a four-digit code and the affected unit address
Ventilation Interlock	Allows the group to be interlocked with Lossnay unit
Schedule Operation	Weekly schedule can be set by groups based on operation pattern
External Input/Output	Inputs: Level Signal–Batch Start/Stop, Batch Emergency Stop Outputs: Start/Stop Status, Error/Normal Status
Power Supply	PAC-SC51KUA
Dimensions – (H x W x D)	4-3/4" x 7-1/8" x 1-3/16"

INPUT/OUTPUT CONTROLLERS

PAC-YG60MCA PULSE INPUT (PI) CONTROLLER

The Pulse Input (PI) controller makes it possible to perform energy saving and energy allocation initiatives. A maximum of four (4) measurement meters (WHM, gas meter, water meter, and calorie meter) can be connected to the PI Controller and trended within the Centralized Controller. *(Note: 24VDC power needs to be provided on-site.)*

STANDARD FEATURES

Function	Description
Display	Displays measurement data via AE-200A, AE-50A, and EW-50A web browser
Monitor	Watt-hour meter, water meter, gas meter, calorimeter
Input	Quantity of 4 non-voltage pulse inputs
Fail-safe device	An internal capacitor will continue to track time for one week in the event of a power failure
Power Supply	24 VDC, 5 W, 0.2 A
Communication	M-NET
Dimensions — (H x W x D)	1-13/16" x 7-7/8" x 4-3/4"

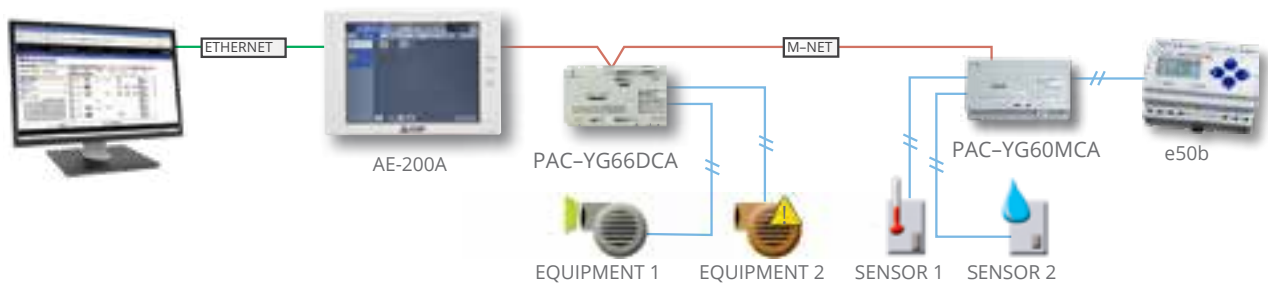

INPUT/OUTPUT CONTROLLERS

PAC-YG66DCA DIGITAL INPUT DIGITAL OUTPUT (DIDO) CONTROLLER

The DIDO controller makes it possible to control general-purpose equipment with an AE-200A, AE-50A, EW-50A, or TC-24B centralized controller. Connect up to six (6) pieces of equipment to the DIDO controller. The equipment can either be scheduled or interlocked with indoor units through the use of a centralized controller. *(Note: 24 VDC power is required on-site.)*

STANDARD FEATURES

Function	Description
Inputs	Qty two Digital Status Inputs and 2 Digital Error Inputs (Non-Voltage Contacts)
Outputs	Qty two Digital Outputs (Non-Voltage Relay Contact Use only VDC with outputs)
Monitor	Status, Fault Requires AE-200A, AE-50A, EW-50A, or TC-24B Centralized Controller
Control	On/Off, Start/Stop, Enable/Disable Requires AE-200A, AE-50A, EW-50A, or TC-24B Centralized Controller
Schedule Operation	Weekly schedule can be set by groups based on operation pattern Requires AE-200A, AE-50A, EW-50A, or TC-24B Centralized Controller
Interlock Function	Interlock M-NET devices and output contacts according to status of input contacts
Power Supply	24 VDC (5W plus loads)
Communication	M-NET
Dimensions — (H x W x D)	4-3/4" x 7-7/8" x 1-13/16"

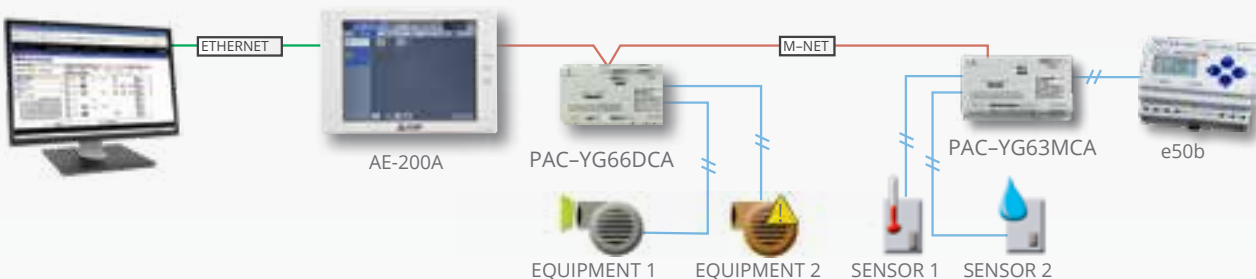

PAC-YG63MCA ANALOG INPUT (AI) CONTROLLER

The AI Controller makes it possible to monitor values measured by the temperature and humidity sensors connected to the AI Controller. The AI Controller has two input and two output channels and is required to be connected with an AE-200A, AE-50A, or EW-50A centralized controller. The user can trend measured data on a Web browser and set alarms to output via e-mail when data exceeds a preset upper or lower limit. *(Note: 24 VDC power is required on-site.)*

STANDARD FEATURES

Function	Description
Inputs	Qty two Analog Inputs (0/10 VDC, 4/20 mA, 1-5 VDC)
Monitor	Temperature and/or Humidity Requires AE-200A, AE-50A or EW-50A centralized controller and field supplied sensor
Interlock Function	Interlock M-NET devices and output contacts according to measured values on inputs
Alarms	Generate alarm based on user defined high and low limits
Power Supply	24 VDC (5W)
Communication	M-NET
Dimensions — (H x W x D)	4-3/4" x 7-7/8" x 1-13/16"

ZONE CONTROLLERS

Remote Controller for CITY MULTI systems featuring an intuitive touch screen interface with dual set point functionality and LED status indicator



PAR-U01MEDU

SMARTME

KEY FEATURES

- ▶ Intuitive backlit touch screen.
- ▶ Group control up to 16 indoor units in a single zone.
- ▶ Onboard temperature, humidity, occupancy, and brightness sensors.
- ▶ Monitors third-party equipment through AdvancedHVAC controller.
- ▶ Supports dual set point and setback functions.
- ▶ Improved scheduling.
- ▶ Color glow status indicator LED bar.
- ▶ Dimensions (H x W x D): 4-3/4" x 5-9/16" x 1".

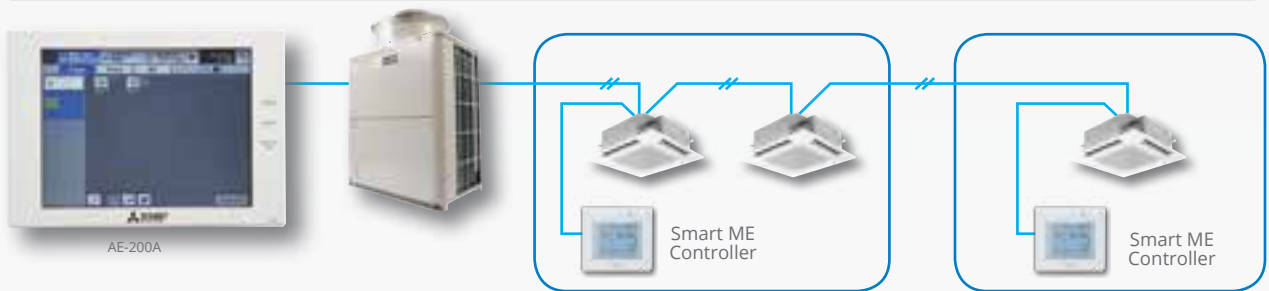

COLOR GLOW STATUS INDICATOR

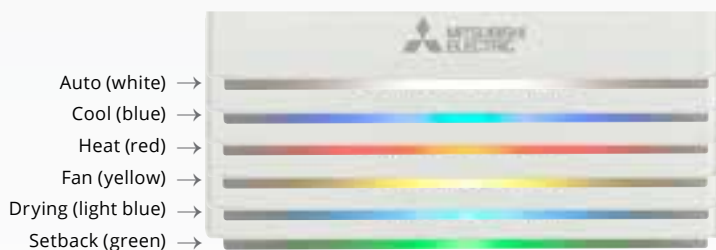

The LED bar indicates the operation status by lighting and blinking with different colors and brightness (High/Low), or by turning off. Multiple operation status indicators include blue (Cooling), light blue (Drying), yellow (Fan), white (Auto), green (Setback), red (Heating) and lime (Energy Save). Advanced settings are available for selecting desired color per mode, LED brightness (in conjunction with room brightness sensor), and temperature range indicator.

ENERGY SAVE FUNCTION

The Energy Save function reduces energy consumption during vacancy. The user can select a mode for the Energy Save function which is activated based on vacancy detection in a room, including the following:

- ▶ Thermo-off: Puts the unit into the Thermo-off state.
- ▶ Set temperature offset: Offsets the set temperature.
- ▶ Fan speed down: Sets the fan speed to Low.
- ▶ ON/OFF: Turns off the unit.
- ▶ Operation mode: Sets the operation mode to Setback.

OCCUPANCY SENSOR

The built-in Occupancy Sensor is used to detect movement in a room. If the sensor detects no movement (or "vacancy") it will activate the selected Energy saving function mode. The Occupancy Sensor returns the system to original operating status after detecting movement. The user can adjust the away time and detection sensitivity threshold level for the Occupancy Sensor. Brightness can also be used in conjunction with motion to determine occupancy.

ZONE CONTROLLERS

Wired remote controller ideal for easy operation, convenience, and energy savings



PAR-33MAA

WIRED MA REMOTE CONTROLLER

KEY FEATURES

- ▶ Controls up to 16 zones
- ▶ Large easy-to-see backlit LCD with two display modes: Full or Basic
- ▶ Interlock and control Lossnay units
- ▶ Operation modes: Auto, Cool, Heat, Dry, Fan
- ▶ Fan speed settings
- ▶ Controls air direction (vane direction and ventilation)
- ▶ Dimensions: 4-3/4" x 3/4" x 4-3/4"
- ▶ Dual set point functionality
- ▶ Daylight Saving Time (DST) included

Easy-to-use remote for temperature and operation mode control



PAC-YT53CRAU

SIMPLE MA

KEY FEATURES

- ▶ Controls up to 16 zones.
- ▶ Backlit LCD.
- ▶ Operation modes of Cool, Heat, Dry, Fan, Auto, Ventilation, Setback (depending on connected equipment).
- ▶ Fan speed settings.
- ▶ Controls air direction (vane direction and ventilation).
- ▶ Dimensions: 2-3/4" x 1-5/8" x 4-3/4".
- ▶ Dual set point functionality.

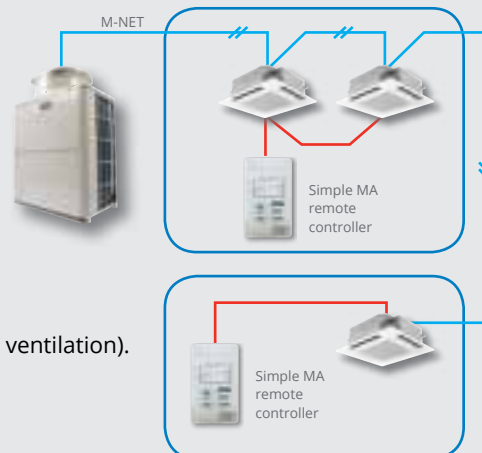

ZONE CONTROLLERS

Easy-to-use hand-held remote for temperature and operation mode control for CITY MULTI® and P-Series systems



PAR-FL32MA

WIRELESS MA REMOTE CONTROLLER AND MA RECEIVER

KEY FEATURES

- ▶ Hand-held wireless remote control of up to 16 indoor units.
- ▶ Operation modes of Cool, Heat, Dry, Fan, Auto, Ventilation.
- ▶ Fan speed, airflow direction settings.
- ▶ Compatible with P-Series and CITY MULTI systems.
- ▶ Requires PAR-FA32MA Wireless Receiver. (Built-in as standard on PKFY models).
- ▶ Dimensions — Remote: 2-5/16" x 3/4" x 5-1/4".
Receiver: 2-3/4" x 7/8" x 4-12/16".

kumo cloud®



KEY FEATURES

- ▶ Compatible with CITY MULTI and M- and P-Series systems *without* a central controller
- ▶ Requires the Wireless Interface (PAC-USWHS002-WF-1)
- ▶ Easy to connect the device to your router using the kumo cloud app
- ▶ App compatible software platforms:
 - Apple iOS 8.0 or later
 - Android 4.1 or later
 - Fire OS 4.1 or later
- ▶ Intuitive settings for simplified use:
 - Group units together
 - Organize groups into sites
 - Batch command units
- ▶ Error and filter status pop-up
- ▶ Advanced functions settings for M- and P-Series equipment

ADVANCEDHVAC CONTROLLER

AdvancedHVAC Controller

The AdvancedHVAC controller features customizable applications for integrating CITY MULTI indoor units with third-party equipment. Physical inputs and outputs can be used for reading sensors and energizing relays. An analog output accessory can be added for modulating third-party equipment signals. Status of inputs and outputs are displayed on the AE-200A, AE-50A, EW-50A web browser and the PAR-U01MEDU SmartME Remote Controller screen.



Auxiliary Heat



Y-Series Changeover



Humidity Control



Ventilation Control

SYSTEM INTEGRATION

The CMCN supports integration with Building Management Systems (BMS) via LonWorks® and BACnet®

The LonWorks® interface, LMAP04U, supports up to 50 indoor units with a variety of network variables on a per indoor unit basis. Input variables include, but are not limited to: On/Off, Operation Mode, Fan Speed, Prohibit Remote Controller, and Filter Sign Reset. Output variables include but are not limited to: Model Size, Alarm State, Error Code, and Error Address.



LONWORKS® INTERFACE

KEY FEATURES

- ▶ Up to 50 units (CITY MULTI, M-Series, P-Series and/or Lossnay) can be connected with one LonWorks interface.
- ▶ Operation/Setting: Request On/Off, Set Point, Request Lossnay Mode, Request Fan Speed, Request Local Prohibit On/Off and Set Point, Request Forced Thermostat Off, Filter Sign Reset, Time Stamp, Request Limit Temperature Setting Range, Request Simplified Locking.
- ▶ Features a built-in power supply (208/230 VAC).
- ▶ Dimensions: 13-7/16" x 14-3/16" x 2-3/8".

The AE-200A/AE-50A/EW-50A centralized controllers are BTL® (BACnet Testing Laboratories) listed, demonstrating their compliance with ASHRAE standards and their compatibility with building management systems supporting the BACnet TCP/IP communication protocol.

BACNET® LICENSE

KEY FEATURES

- ▶ Connect up to 50 indoor units per licensed controller.
- ▶ Supports the monitoring and operation of CITY MULTI indoor units, M- and P-Series indoor units (requires additional adapter), and Lossnay ERV units.
- ▶ BACnet TCP/IP
- ▶ Licensed feature of the centralized controller

DIAMOND CONTROLS®

A branded, bundled, and seamless building controls solution packaged with our variable refrigerant flow (VRF).

Diamond Controls is powered by the industry-leading Niagara 4 Framework®, the industry's first software technology designed to integrate diverse building systems and devices into one seamless system. Niagara supports a wide range of protocols, including LonWorks™, BACnet™, Modbus®, oBIX and Internet standards. The Niagara 4 Framework also includes integrated network management tools to support the design, configuration, installation and maintenance of interoperable networks.



DC-8000

The DC-8000 is an embedded controller/server platform that combines integrated control, supervision, data logging, alarming, scheduling and network management functions into a small, compact platform with network connectivity and web serving capabilities. The DC-8000 makes it possible to control and manage external devices over the network, presenting real-time information to users in web-based graphical views.



DCPro

The DCPro is a flexible network server for all connected DC-8000 stations. The DCPro provides efficient integration of standard open protocols. The DCPro creates a powerful network environment with comprehensive database management functionality, alarm management, and messaging services. DCPro can manage global control functions, support data passing over multiple networks, connect to enterprise-level software applications, and host multiple, simultaneous client workstations connected over a local network or the Internet.

CONTROLS SOLUTIONS

Controls Solutions is a group of industry experts located across the country who are ready to assist with every aspect of our heating and cooling systems. By utilizing Controls Solutions, a building owner has peace of mind that the project will seamlessly move forward with minimal hiccups. With one company providing the equipment and the controls, project execution is much more efficient.

Controls Solutions offerings include:

- ▶ Project Supervision
- ▶ Owner Training
- ▶ System Start-up
- ▶ Project Training
- ▶ System Commissioning
- ▶ Design Support
- ▶ Retro-commissioning
- ▶ System Evaluation

DIAMOND CONTROLS APPLICATIONS



HIGH-RESOLUTION 3D GRAPHICS

Diamond Controls enables a new graphical user experience for variable refrigerant flow (VRF) zoning systems with the inclusion of high resolution three-dimensional floor plan graphics of your building.

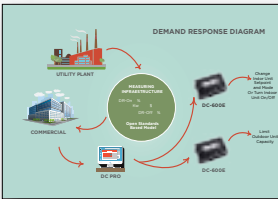

DEMAND RESPONSE COMPLIANCE

Demand Response programs help utilities maintain grid reliability and enable customers to realize significant value. Diamond Controls provides Demand Response compliance to a building owner through OpenADR.



LIGHTING CONTROL

Diamond Controls can manage a building's lighting system without requiring integration with third-party equipment. Lighting control provides a building manager the ability to set lighting schedules, which can be overridden by local switches if necessary.



CENTRAL PLANT CONTROL

Diamond Controls can monitor, control, and schedule a central plant to provide chilled or hot water for the building's needs without requiring additional third-party controls.



ADVANCED ALARMING

Diamond Controls advanced logic enables superior alarming capabilities for building awareness, as well as VRF zoning systems. The building owner can set up multiple alarm conditions ranging from simple out-of-range alarms to advanced condition alarms.



HVAC EQUIPMENT INTEGRATION

Diamond Controls can schedule, monitor, control, and integrate advanced logic within various HVAC manufacturers' equipment. Diamond Controls can also easily integrate into an existing building management system (BMS).

DIAMOND SYSTEM BUILDER™

Diamond System Builder is an interactive system layout tool providing a simple and efficient means of system design.

Diamond System Builder (DSB) helps users determine the cooling and heating output of selected equipment for project-specific conditions. The program has error indicators and built-in safeguards against exceeding limitations, assuring line lengths, maximum connected capacities, component selections, control schemes, etc. are within the system requirements.



PROJECT PROPERTIES

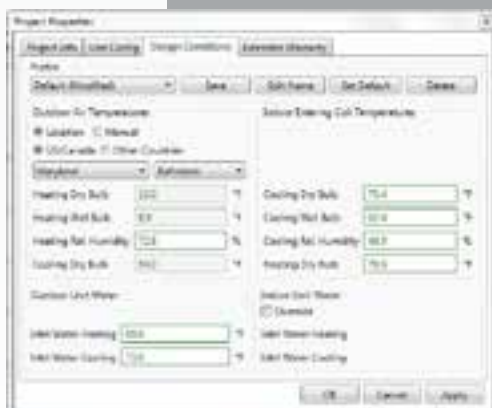

System design conditions, such as indoor and outdoor design conditions, are easily entered for both cooling and heating. Customer and project names can be entered to identify the job on the outputs.

DSB INTERFACE



Optional functions to customize the system layout to your project are available, such as labeling groups with a room name, adding equipment tags to pieces of equipment, and giving each system a project-specific name. Other features, like a custom equipment schedule, submittal packages, and AutoCAD drawings are available once the system layout has been finalized.

REVIT AND AUTOCAD OUTPUTS



MAINTENANCE TOOL

Easy-to-use, Windows®-based Maintenance Tool software

Use Maintenance Tool software to monitor pressure and temperature readings from CITY MULTI system sensors, display and control system LEV settings, and display and remotely control all connected indoor units. Maintenance Tool software also allows the technician to record and save system operational data for the purposes of trending and system analysis off-site as well as display malfunction logs and email error reports to personnel responsible for servicing the system.



CMS-MNG-E

MN CONVERTER

KEY FEATURES

- ▶ Allows technicians to monitor and collect CITY MULTI system data and control various functions.
- ▶ System monitoring accomplished through direct connection between your PC and the M-NET bus line using the MN-Converter.

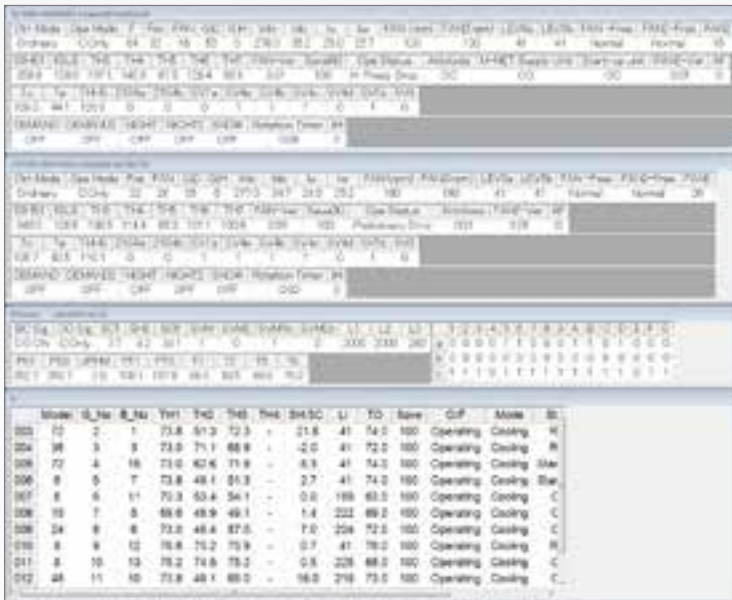

The mode select screen allows the user to select the method for connection to the CITY MULTI system, whether direct or remotely, or choose to analyze previously recorded data offline.

The operation status monitor screen displays the operational data for the connected system, including system pressures, temperatures, LEV settings, compressor frequency, current operational mode, and more. Pre-recorded data can also be viewed in an off-line version of this screen.

SPECIFICATION TABLES

SPECIFICATIONS: L-GENERATION R2-SERIES ▼



PURY-P** (T/Y) LMU-A

Model Name			208V /230V	PURY-P72TLMU-A (-BS)	PURY-P96TLMU-A (-BS)	PURY-P120TLMU-A (-BS)	PURY-P144TLMU-A (-BS)	PURY-P168TLMU-A (-BS)
			460V	PURY-P72YLMU-A (-BS)	PURY-P96YLMU-A (-BS)	PURY-P120YLMU-A (-BS)	PURY-P144YLMU-A (-BS)	PURY-P168YLMU-A (-BS)
Power Source			208/230V, 3-Phase, 60Hz 460V, 3-Phase, 60Hz					
Capacity (Nominal) *1	Cooling	Btu/h Capacity	72,000	96,000	120,000	144,000	168,000	
	Heating	Btu/h Capacity	80,000	108,000	135,000	160,000	188,000	
Electrical Supply	MCA	A	24/22 11	33/30 15	42/39 19	52/48 24	68/63 31	
	MOP	A	35/35 20	50/50 25	60/60 30	80/70 35	110/100 50	
Fan	Type X Quantity		Propeller Fan x 1			Propeller Fan x 2		
	Airflow Rate	CFM	6,550			11,300		
	External Static Pressure		Selectable; 0, 0.12 or 0.24"W.G.; factory set to 0"W.G.					
Compressor	Type X Quantity		INVERTER-driven Scroll Hermetic x 1					
	Operating Range		13% to 100%		15% to 100%		12% to 100%	
	Lubricant		MEL32					
Refrigerant	Type		R410A					
External Finish			Precoated galvanized steel sheet (plus powder Coating for -BS type) <MUNSELL 5Y 8/1 or similar>					
Dimensions H x W x D	Height	In.	64-31/32					
	Width	In.	36-1/4	48-1/16	68-29/32			
	Depth	In.	29-5/32					
Net Weight	Pounds		444 474	503 534	695 730	702 730		
	Sound Pressure Level (Measured In Anechoic Room)		dB(A)		58.0	60.0	61.0	
Protection Devices	High Pressure Protection		High pressure sensor, High pressure switch					
	Inverter Circuit (Compressor/Fan)		Over-current protection					
Refrigerant Pipe Dimensions	Liquid (High Pressure) (Brazed)	In.	5/8	3/4			7/8	
	Gas (Low Pressure) (Brazed)	In.	3/4	1-1/8	7/8	1-1/8		
Indoor Unit	Total Capacity		50% to 150% of outdoor unit capacity					
Connectable	Model/Quantity		P06 - P72/1 to 18	P06 - P96/1 to 24	P06 - P96/1 to 30	P06 - P96/1 to 36	P06 - P96/1 to 42	
Operating Temperature Range	Cooling	D.B.	**Outdoor: 23° to 126° F					
	Heating	W.B.	Outdoor: -13° to 60° F					
Efficiency Ratings *2								
EER (Ducted/Non-Ducted) *2			13.5/14.8	12.0/14.1	12.8/14.7	12.2/14.0	10.6/11.2	
IEER (Ducted/Non-Ducted) *2			23.1/28.1	24.1/27.0	19.9/24.6	19.7/24.3	15.9/19.6	
COP (Ducted/Non-Ducted) *2			3.65/4.30	3.53/4.00	3.52/3.99	3.38/3.72	3.24/3.49	
SCHE (Ducted/Non-Ducted) *2			25.9/28.4	23.5/31.5	25.3/30.3	24.8/27.7	24.7/28.3	

Notes:

*1. Rating Conditions:
Cooling | Indoor: 80°F (26.7°C) DB/67°F (19°C) WB; Outdoor: 95°F (35°C) DB.
Heating | Indoor: 70°F (21.1°C) DB; Outdoor: 47°F (8.3°C) DB/43°F (6°C) WB.
*2. Efficiency values based on AHRI 1230 test method

LIMITED WARRANTY | Seven-year warranty on compressor. One-year warranty on parts. See our website for details on specific additional application installation coverage. Specifications are subject to change.

** Extended ambient cooling operation range down to -10° F DB Low Ambient Kit required.

-BS indicates Seacoast Protection option.



PURY-P** (T/Y) LMU-A

Model Name		208V /230V	PURY-P144TSLMU-A (-BS) *2 With 2 PURY-P72TLMU-A (-BS) *3	PURY-P168TSLMU-A (-BS) *2 With 1 PURY-P72TLMU-A (-BS) and 1 PURY-P96TLMU-A (-BS) *3	PURY-P192TSLMU-A (-BS) *2 With 2 PURY-P96TLMU-A (-BS) *3	PURY-P216TSLMU-A (-BS) *2 With 1 PURY-P96TLMU-A (-BS) and 1 PURY-P120TLMU-A (-BS) *3	PURY-P240TSLMU-A (-BS) *2 With 2 PURY-P120TLMU-A (-BS) *3	
		460V	PURY-P144YSLMU-A (-BS) *2 With 2 PURY-P72YLMU-A (-BS) *3	PURY-P168YSLMU-A (-BS) *2 With 1 PURY-P72YLMU-A (-BS) and 1 PURY- P96YLMU-A (-BS) *3	PURY-P192YSLMU-A (-BS) *2 With 2 PURY-P96YLMU-A (-BS) *3	PURY-P216YSLMU-A (-BS) *2 With 1 PURY-P96YLMU-A (-BS) and 1 PURY- P120YLMU-A (-BS) *3	PURY-P240YSLMU-A (-BS) *2 With 2 PURY-P120YLMU-A (-BS) *3	
Power Source		208V/230V, 3-Phase, 60Hz 460V, 3-Phase, 60Hz						
Capacity (Nominal) *1	Cooling	Btu/h Capacity	144,000	168,000	192,000	216,000	240,000	
	Heating	Btu/h Capacity	160,000	188,000	215,000	243,000	270,000	
Fan	Type X Quantity		Refer to: PURY-P72TLMU-A (-BS) PURY-P72YLMU-A (-BS)	Refer to: PURY-P72TLMU-A (-BS)/ PURY-P96TLMU-A (-BS) PURY-P72YLMU-A (-BS)/ PURY-P96YLMU-A (-BS)	Refer to: PURY-P96TLMU-A (-BS) PURY-P96YLMU-A (-BS)	Refer to: PURY-P96TLMU-A (-BS)/ PURY-P120TLMU-A (-BS) PURY-P96YLMU-A (-BS)/ PURY-P120YLMU-A (-BS)	Refer to: PURY-P120TLMU-A (-BS) PURY-P120YLMU-A (-BS)	
	Airflow Rate							CFM
	External Static Pressure							
Compressor	Type X Quantity		6% to 100%			5% to 100%		
	Operating Range							
Refrigerant	Lubricant							
	Type		Refer to: PURY-P72TLMU-A (-BS) PURY-P72YLMU-A (-BS)			Refer to: PURY-P96TLMU-A (-BS) PURY-P96YLMU-A (-BS)		
External Finish		Refer to: PURY-P120TLMU-A (-BS) PURY-P120YLMU-A (-BS)						
Dimensions H x W x D	Height	In.						
	Width	In.						
	Depth	In.						
Net Weight		Pounds						
Sound Pressure Level (Measured In Anechoic Room)		dB(A)	61.0			62.0		
Protection Devices	High Pressure Protection		High pressure sensor, High pressure switch					
	Inverter Circuit (Compressor/Fan)		Over-current protection					
Refrigerant Pipe Dimensions	Gas (Low Pressure) (Brazed)	In.	7/8			1-1/8		
	Liquid (High Pressure) (Brazed)	In.	1-1/8			1-3/8		
Indoor Unit Connectable	Total Capacity		50% to 150% of outdoor unit capacity					
	Model/Quantity		P06-P96/1 to 36	P06-P96/1 to 42	P06-P96/1 to 48	P06-P96/2 to 50 *4	P06-P96/2 to 50 *4	
Operating Temperature Range	Cooling	D.B.	**Outdoor: 23° to 126° F					
	Heating	W.B.	Outdoor: -13° to 60° F					
Efficiency Ratings *5								
EER (Ducted/Non-Ducted) *5		12.3/14.2		11.0/12.6	11.4/12.1	11.7/12.4	11.8/12.9	
IEER (Ducted/Non-Ducted) *5		21.2/26.6		19.9/24.8	23.5/23.9	21.5/22.9	19.0/22.3	
COP (Ducted/Non-Ducted) *5		3.58/4.07		3.39/3.77	3.53/3.59	3.52/3.59	3.45/3.64	
SCHE (Ducted/Non-Ducted) *5		25.0/28.8		24.9/29.4	23.0/28.0	22.7/26.9	22.9/26.8	

Notes:

*1 Rating Conditions:

Cooling | Indoor: 80°F (26.7°C) DB/67°F (19°C) WB; Outdoor: 95°F (35°C) DB.
Heating | Indoor: 70°F (21.1°C) DB; Outdoor: 47°F (8.3°C) DB/43°F (6°C) WB.

*2 Twinning Kit is required for combining two individual outdoor units in the field for PURY-P-T(Y)SLMU combined systems.

*3 Each individual outdoor unit requires a separate electrical connection. Reference electrical data for each individual outdoor unit.

*4 Maximum connectable number of branch pipes is 48.

*5 Efficiency values based on AHRI 1230 test method

** Extended ambient cooling operation range down to -10° F DB Low Ambient Kit required.

NOTES: In systems with considerably long piping runs, the outdoor units may exhibit slightly louder than normal sound pressure levels when in heating mode.

The outdoor twinning kit (low pressure) should be connected to the low pressure side of the outdoor unit. If the connected units are different capacities, the outdoor twinning kit (low pressure) should be installed in the unit with the largest capacity.

-BS indicates Seacoast Protection option.

LIMITED WARRANTY | Seven-year warranty on compressor. One-year warranty on parts. See our website for details on specific additional application installation coverage.

Specifications are subject to change.

SPECIFICATIONS: L-GENERATION ▼



PURY-P** (T/Y) LMU-A

Model Name			208V /230V	PURY-P264TSLMU-A (-BS) *2 With 1 PURY-P120TLMU-A (-BS) and 1 PURY-P144TLMU-A (-BS) *3	PURY-P288TSLMU-A (-BS) *2 With 2 PURY-P144TLMU-A (-BS) *3	PURY-P312TSLMU-A (-BS)*2 With 1 PURY-P144TLMU-A (-BS) and 1 PURY-P168TLMU-A (-BS) *3	PURY-P336TSLMU-A (-BS)*2 With 2 PURY-P168TLMU-A (-BS) *3
			460V	PURY-P264YSLMU-A (-BS) *2 With 1 PURY-P120YLMU-A (-BS)* and 1 PURY-P144YLMU-A (-BS) *3	PURY-P288YSLMU-A (-BS) * *2 With 2 PURY-P144YLMU-A (-BS) *3	PURY-P312YSLMU-A (-BS) * *2 With 1 PURY-P144YLMU-A (-BS) and 1 PURY-P168YLMU-A (-BS) *3	PURY-P336YSLMU-A (-BS) * *2 With 2 PURY-P168YLMU-A (-BS) *3
Power Source			208/230V 3-Phase, 60Hz 460V, 3-Phase, 60Hz				
Capacity (Nominal) *1	Cooling	Btu/h Capacity	264,000	288,000	312,000	336,000	
	Heating	Btu/h Capacity	295,000	323,000	350,000	378,000	
Fan	Type X Quantity		Refer to: PURY-P120TLMU-A (-BS)/ PURY-P144TLMU-A (-BS) PURY-P120YLMU-A (-BS)/ PURY-P144YLMU-A (-BS)	Refer to: PURY-P144TLMU-A (-BS) PURY-P144YLMU-A (-BS)	Refer to: PURY-P144TLMU-A (-BS) PURY-P168TLMU-A PURY-P144YLMU-A (-BS) PURY-P168YLMU-A	Refer to: PURY-P168TLMU-A (-BS) PURY-P168YLMU-A (-BS)	
	Airflow Rate						CFM
Compressor	Type X Quantity		7% to 100%			6% to 100%	
	Operating Range						
Refrigerant	Type		Refer to: PURY-P120TLMU-A (-BS)/ PURY-P144TLMU-A (-BS)	Refer to: PURY-P144TLMU-A (-BS) PURY-P144YLMU-A (-BS)	Refer to: PURY-P144TLMU-A (-BS) PURY-P168TLMU-A	Refer to: PURY-P168TLMU-A (-BS) PURY-P168YLMU-A (-BS)	
External Finish							
Dimensions H x W x D	Height	In.					
	Width	In.	PURY-P120YLMU-A (-BS)/ PURY-P144YLMU-A (-BS)				
	Depth	In.	PURY-P144YLMU-A (-BS) PURY-P168YLMU-A				
Net Weight		Pounds					
Sound Pressure Level (Measured In Anechoic Room)		dB(A)	63.5	64.0			
Protection Devices	High Pressure Protection		High pressure sensor, High pressure switch				
	Inverter Circuit (Compressor/Fan)		Over-current protection				
Refrigerant Pipe Dimensions	Gas (Low Pressure) (Brazed)	In.	1-1/8				
	Liquid (High Pressure) (Brazed)	In.	1-3/8	1-5/8			
Indoor Unit Connectable	Total Capacity		50% to 150% of outdoor unit capacity				
	Model/Quantity		P06 – P96/2 to 50 *4				
Operating Temperature Range	Cooling	D.B.	**Outdoor: 23° to 126° F				
	Heating	W.B.	Outdoor: -13° to 60° F				
Efficiency Ratings *5							
EER (Ducted/Non-Ducted) *5			11.5/12.5	11.3/12.2	10.5/11.0	9.9/9.7	
IEER (Ducted/Non-Ducted) *5			18.7/21.9	18.5/21.9	16.9/19.7	15.3/17.6	
COP (Ducted/Non-Ducted) *5			3.36/3.49	3.28/3.38	3.24/3.27	3.19/3.23	
SCHE (Ducted/Non-Ducted) *5			22.3/25.7	21.7/24.5	20.6/23.8	20.4/23.4	

Notes:

*1 Rating Conditions:

Cooling | Indoor: 80°F (26.7°C) DB/67°F (19°C) WB; Outdoor: 95°F (35°C) DB.

Heating | Indoor: 70°F (21.1°C) DB; Outdoor: 47°F (8.3°C) DB/43°F (6°C) WB.

*2 Twinning Kit is required for combining two individual outdoor units in the field for PURY-P-T(Y)SLMU combined systems.

*3 Each individual outdoor unit requires a separate electrical connection. Reference electrical data for each individual outdoor unit.

*4 Maximum connectable number of branch pipes is 48.

*5 Efficiency values based on AHRI 1230 test method

** Extended ambient cooling operation range down to -10° F DB Low Ambient Kit required.

NOTES: In systems with considerably long piping runs, the outdoor units may exhibit slightly louder than normal sound pressure levels when in heating mode.

The outdoor twinning kit (low pressure) should be connected to the low pressure side of the outdoor unit. If the connected units are different capacities, the outdoor twinning kit (low pressure) should be installed in the unit with the largest capacity.

-BS indicates Seacoast Protection option.

LIMITED WARRANTY | Seven-year warranty on compressor. One-year warranty on parts. See our website for details on specific additional application installation coverage.

Specifications are subject to change.



SPECIFICATIONS: L-GENERATION Y-SERIES ▼

PUHY-P** (T/Y) LMU-A

Model Name		208V/ 230V	PUHY-P72TLMU-A (-BS)	PUHY-P96TLMU-A (-BS)	PUHY-P120TLMU-A (-BS)	PUHY-P144TLMU-A (-BS)	PUHY-P168TLMU-A (-BS)
		460V	PUHY-P72YLMU-A (-BS)	PUHY-P96YLMU-A (-BS)	PUHY-P120YLMU-A (-BS)	PUHY-P144YLMU-A (-BS)	PUHY-P168YLMU-A (-BS)
Power Source		208/230V, 3-Phase, 60Hz/ 460V, 3-Phase, 60Hz					
Capacity (Nominal) *1	Cooling	Btu/h Capacity	72,000	96,000	120,000	144,000	168,000
	Heating	Btu/h Capacity	80,000	108,000	135,000	160,000	188,000
Electrical Supply	MCA	A	24/22 11	32/29 14	42/39 19	46/43 21	58/54 26
	MOP	A	35/35 15	50/45 20	60/60 30	70/70 35	90/80 40
Fan	Type X Quantity	Propeller Fan x 1		Propeller Fan x 2			
	Airflow Rate	CFM	6,200	6,700	11,300		12,700
	External Static Pressure	Selectable; 0, 0.12 or 0.24"WG; factory set to 0"W.G.					
Compressor	Type X Quantity	INVERTER-driven Scroll Hermetic x 1					
	Operating Range	13% to 100%			15% to 100%		12% to 100%
	Lubricant	MEL32					
Refrigerant	Type	R410A					
External Finish	Precoated galvanized steel sheet (plus powder Coating for -BS type) <MUNSELL 5Y 8/1 or Similar>						
Dimensions H X W X D	Height	In.	64-31/32				
	Width	In.	36-1/4	48-1/16	68-29/32		
	Depth	In.	29-5/32"				
Net Weight	Pounds	435 468	499 532	671 706		673 702	
Sound Pressure Level (Measured In Anechoic Room)	dB(A)	58.0		60.0	61.0		62.0
Protection Devices	High Pressure Protection	High pressure sensor, High pressure switch					
	Inverter Circuit (Compressor/Fan)	Over-current protection					
Refrigerant Pipe Dimensions	Liquid (High Pressure) (Brazed)	In.	3/8	3/8 (1/2", length to first joint ≥ 295')	3/8 (1/2", length to first joint ≥ 131')	1/2	5/8
	Gas (Low Pressure) (Brazed)	In.	7/8		1-1/8		
Indoor Unit Connectable	Total Capacity	50% to 130% of outdoor unit capacity					
	Model/Quantity	P06 - P72/1 to 15		P06 - P96/1 to 20	P06 - P96/1 to 26	P06 - P96/1 to 31	P06 - P96/1 to 36
Operating Temperature Range	Cooling	D.B.	**Outdoor: 23° to 126° F				
	Heating	W.B.	Outdoor: -13° to 60° F				
System Efficiencies *2							
EER (Ducted/Non-Ducted) *2		13.7/16.4		13.1/15.5	13.2/14.9	12.5/14.0	11.6/12.5
IEER (Ducted/Non-Ducted) *2		23.1/28.1		23.1/28.2	21.9/25.3	21.2/24.7	18.7/22.2
COP (Ducted/Non-Ducted) *2		3.84/4.44		3.79/4.27	3.71/4.17	3.55/3.88	3.47/3.77

Notes:

*1 Rating Conditions:

Cooling | Indoor: 80°F (26.7°C) DB/67°F (19°C) WB; Outdoor: 95°F (35°C) DB.

Heating | Indoor: 70°F (21.1°C) DB; Outdoor: 47°F (8.3°C) DB/43°F (6°C) WB.

*2 Efficiency values based on AHRI 1230 test method.

** Extended ambient cooling operation range down to -10° F DB Low Ambient Kit required.

-BS indicates Seacoast Protection option.

LIMITED WARRANTY | Seven-year warranty on compressor. One-year warranty on parts. See our website for details on specific additional application installation coverage.

Specifications are subject to change.



SPECIFICATIONS: L-GENERATION ▼

PUHY-P** (T/Y) LMU-A

Model Name			208V/ 230V	PUHY-P144TSLMU-A (-BS) *2	PUHY-P168TSLMU-A (-BS) *2	PUHY-P192TSLMU-A (-BS) *2	PUHY-P216TSLMU-A (-BS) *2	PUHY-P240TSLMU-A (-BS) *2
			460V	With 2 PUHY-P72TLMU-A (-BS) *3	With 1 PUHY-P72TLMU-A (-BS) and 1 PUHY- P96TLMU-A (-BS) *3	With 1 PUHY-P72TLMU-A (-BS) and 1 PUHY- P120TLMU-A (-BS)	With 1 PUHY-P96TLMU-A (-BS) and 1 PUHY- P120TLMU-A (-BS) *3	With 2 PUHY-P120TLMU-A (-BS) *3
				PUHY-P144YSLMU-A (-BS) *2	PUHY-P168YSLMU-A (-BS) *2	PUHY-P192YSLMU-A (-BS) *2	PUHY-P216YSLMU-A (-BS) *2	PUHY-P240YSLMU-A (-BS) *2
				With 2 PUHY-P72YLMU-A (-BS) *3	With 1 PUHY-P72YLMU-A (-BS) and 1 PUHY- P96YLMU-A (-BS) *3	With 1 PUHY-P72YLMU (-BS) and 1 PUHY-P120YLMU- A (-BS) *3	With 1 PUHY-P96YLMU-A (-BS) and 1 PUHY- P120YLMU-A (-BS) *3	With 2 PUHY-P120YLMU-A (-BS) *3
Power Source			208/230V, 3-Phase, 60Hz 460V, 3-Phase, 60Hz					
Capacity (Nominal) *1	Cooling	Btu/h Capacity	144,000	168,000	192,000	216,000	240,000	
	Heating	Btu/h Capacity	160,000	188,000	215,000	243,000	270,000	
Fan	Type X Quantity		Refer to: PUHY-P72TLMU-A (-BS) PUHY-P72YLMU-A (-BS)	Refer to: PUHY-P72TLMU-A (-BS)/ PUHY-P96TLMU-A (-BS)	Refer to: PUHY-P72TLMU-A (-BS) / PUHY-P120TLMU-A (-BS)	Refer to: PUHY-P96TLMU-A (-BS)/ PUHY-P120TLMU-A (-BS)	Refer to: PUHY-P120TLMU-A (-BS)	
	Airflow Rate	CFM						
	External Static Pressure							
Compressor	Type X Quantity		6% to 100%	5% to 100%	7% to 100%			
	Operating Range							
	Lubricant							
Refrigerant	Type		Refer to: PUHY-P72TLMU-A (-BS)	Refer to: PUHY-P72TLMU-A (-BS)/ PUHY-P96TLMU-A (-BS)	Refer to: PUHY-P72TLMU-A (-BS) / PUHY-P120TLMU-A (-BS)	Refer to: PUHY-P96TLMU-A (-BS)/ PUHY-P120TLMU-A (-BS)	Refer to: PUHY-P120TLMU-A (-BS)	
External Finish	Type		PUHY-P72YLMU-A (-BS)	PUHY-P72YLMU-A (-BS)/ PUHY-P96YLMU-A (-BS)	PUHY-P72YLMU-A (-BS)/ PUHY-P120YLMU-A (-BS)	PUHY-P96YLMU-A (-BS)/ PUHY-P120YLMU-A (-BS)	PUHY-P120YLMU-A (-BS)	
Dimensions H X W X D	Height	In.	PUHY-P72YLMU-A (-BS)	PUHY-P72YLMU-A (-BS)/ PUHY-P96YLMU-A (-BS)	PUHY-P72YLMU-A (-BS)/ PUHY-P120YLMU-A (-BS)	PUHY-P96YLMU-A (-BS)/ PUHY-P120YLMU-A (-BS)	PUHY-P120YLMU-A (-BS)	
	Width	In.						
	Depth	In.						
Net Weight	Pounds							
Sound Pressure Level (Measured In Anechoic Room)	dB(A)		61.0	62.5	63.0			
Protection Devices	High Pressure Protection		High pressure sensor, High pressure switch					
	Inverter Circuit (Compressor/Fan)		Over-current protection					
Refrigerant Pipe Dimensions	Liquid (High Pressure) (Braze)	In.	1/2	5/8				
	Gas (Low Pressure) (Braze)	In.	1-1/8					
Indoor Unit Connectable	Total Capacity		50% to 130% of outdoor unit capacity					
	Model/Quantity		P06 - P96/1 to 31	P06 - P96/1 to 36	P06 - P96/1 to 41	P06 - P96/2 to 46	P06 - P96/2 to 50	
Operating Temperature Range	Cooling	D.B.	**Outdoor: 23° to 126° F					
	Heating	W.B.	Outdoor: -13 to 60° F					
System Efficiencies *4								
EER (Ducted/Non-Ducted) *4			12.6/14.6	12.0/14.0	12.4/13.5	12.1/13.3	12.1/13.1	
IEER (Ducted/Non-Ducted) *4			21.3/26.0	21.0/25.0	21.1/24.5	21.0/24.5	20.8/23.5	
COP (Ducted/Non-Ducted) *4			3.60/4.10	3.50/3.90	3.61/3.70	3.56/3.64	3.52/3.67	

Notes:

- *1 Rating Conditions:
Cooling | Indoor: 80°F (26.7°C) DB/67°F (19°C) WB; Outdoor: 95°F (35°C) DB.
Heating | Indoor: 70°F (21.1°C) DB; Outdoor: 47°F (8.3°C) DB/43°F (6°C) WB.
- *2 Twinning Kit is required for combining two or three individual outdoor units in the field for PUHY-P(T)YSLMU combined systems.
- *3 Each individual outdoor unit requires a separate electrical connection. Reference electrical data for each individual outdoor unit.
- *4 Efficiency values based on AHRI 1230 test method.

** Extended ambient cooling operation range down to -10° F DB Low Ambient Kit required.

-BS indicates Seacoast Protection option.

LIMITED WARRANTY | Seven-year warranty on compressor. One-year warranty on parts. See our website for details on specific additional application installation coverage.

Specifications are subject to change.



SPECIFICATIONS: L-GENERATION ▼

PUHY-P** (T/Y) LMU-A

Model Name			208V/ 230V	PUHY-P264TSLMU-A (-BS) *2 With 2 PUHY-P72TLMU-A (-BS) and 1 PUHY- P120TLMU-A (-BS) *3	PUHY-P288TSLMU-A (-BS) *2 With PUHY-P72TLMU-A (-BS)/PUHY-P96TLMU-A (-BS)/PUHY-P120TLMU-A (-BS) *3	PUHY-P312TSLMU-A (-BS) *2 With 1 PUHY-P72TLMU-A (-BS) and 2 PUHY- P120TLMU-A (-BS) *3	PUHY-P336TSLMU-A (-BS) *2 With 1 PUHY-P96TLMU-A (-BS) and 2 PUHY- P120TLMU-A (-BS) *3	PUHY-P360TSLMU-A (-BS) *2 With 3 PUHY-P120TLMU-A (-BS) *3
			460V	PUHY-P264YSLMU-A (-BS) *2 With 2 PUHY-P72YLMU-A (-BS) and 1 PUHY- P120YLMU-A (-BS) *3	PUHY-P288YSLMU-A (-BS) *2 With PUHY-P72YLMU-A (-BS)/PUHY-P96YLMU-A (-BS)/ PUHY-P120YLMU-A (-BS) *3	PUHY-P312YSLMU-A (-BS) *2 With 1 PUHY-P72YLMU-A (-BS) and 2 PUHY- P120YLMU-A (-BS) *3	PUHY-P336YSLMU-A (-BS) *2 With 1 PUHY-P96YLMU-A (-BS) and 2 PUHY- P120YLMU-A (-BS) *3	PUHY-P360YSLMU-A (-BS) *2 With 3 PUHY-P120YLMU-A (-BS) *3
Power Source			208/230V, 3-Phase, 60Hz 208/230v					
Capacity (Nominal) *1	Cooling	Btu/h Capacity	264,000	288,000	312,000	336,000	360,000	
	Heating	Btu/h Capacity	295,000	323,000	350,000	378,000	405,000	
Fan	Type X Quantity	CFM	Refer to: PUHY-P72TLMU-A (-BS)/ PUHY-P120TLMU-A (-BS)	Refer to: PUHY-P72TLMU-A (-BS)/ PUHY-P96TLMU-A (-BS)/ PUHY-P120TKMU (-BS)	Refer to: PUHY-P72TLMU-A (-BS)/ PUHY-P120TLMU-A (-BS)	Refer to: PUHY-P96TLMU-A (-BS)/ PUHY-P120TLMU-A (-BS)	Refer to: PUHY-P120TLMU-A (-BS)	
	Airflow Rate							External Static Pressure
Compressor	Type X Quantity		PUHY-P72YLMU-A (-BS)/ PUHY-P120YLMU-A (-BS)	PUHY-P72YLMU-A (-BS)/ PUHY-P96YLMU-A (-BS)/ PUHY-P120YLMU-A (-BS)	PUHY-P72YLMU-A (-BS)/ PUHY-P120YLMU-A (-BS)	PUHY-P96YLMU-A (-BS)/ PUHY-P120YLMU-A (-BS)	PUHY-P120YLMU-A (-BS)	
	Operating Range	W	4% to 100%		3% to 100%		5% to 100%	
	Crankcase Heater	Lubricant	Refer to: PUHY-P72TLMU-A (-BS)/ PUHY-P120TLMU-A (-BS)	Refer to: PUHY-P72TLMU-A (-BS)/ PUHY-P96TLMU-A (-BS)/ PUHY-P120TKMU (-BS)	Refer to: PUHY-P72TLMU-A (-BS)/ PUHY-P120TLMU-A (-BS)	Refer to: PUHY-P96TLMU-A (-BS)/ PUHY-P120TLMU-A (-BS)	Refer to: PUHY-P120TLMU-A (-BS)	
Refrigerant	Type		PUHY-P72YLMU-A (-BS)/ PUHY-P120YLMU-A (-BS)	PUHY-P72YLMU-A (-BS)/ PUHY-P96YLMU-A (-BS)/ PUHY-P120YLMU-A (-BS)	PUHY-P72YLMU-A (-BS)/ PUHY-P120YLMU-A (-BS)	PUHY-P96YLMU-A (-BS)/ PUHY-P120YLMU-A (-BS)	PUHY-P120YLMU-A (-BS)	
External Finish			PUHY-P72YLMU-A (-BS)/ PUHY-P120YLMU-A (-BS)					
Dimensions H X W X D	Height	In.	PUHY-P72YLMU-A (-BS)/ PUHY-P120YLMU-A (-BS)					
	Width	In.						
	Depth	In.						
Net Weight		Pounds	PUHY-P72YLMU-A (-BS)/ PUHY-P96YLMU-A (-BS)/ PUHY-P120YLMU-A (-BS)					
Sound Pressure Level (Measured In Anechoic Room)		dB(A)	63.5	64.0	64.5		65.0	
Protection Devices	High Pressure Protection		High pressure sensor, High pressure switch					
	Inverter Circuit (Compressor/Fan)		Over-current protection					
Refrigerant Pipe Dimensions	Liquid (High Pressure) (Brazed)	In.	3/4					
	Gas (Low Pressure) (Brazed)	In.	1-3/8			1-5/8		
Indoor Unit Connectable	Total Capacity		50 to 130% of outdoor unit capacity					
	Model/Quantity		P06 - P96/2 to 50					
Operating Temperature Range	Cooling	D.B.	**Outdoor: 23° to 126° F					
	Heating	W.B.	Outdoor: -13° to 60° F					
System Efficiencies *4								
EER (Ducted/Non-Ducted) *4			12.4/13.6	12.0/13.5	12.0/13.4	11.8/13.2	11.8/13.1	
IEER (Ducted/Non-Ducted) *4			21.1/24.0	20.4/24.0	20.3/23.4	20.3/23.4	20.1/22.7	
COP (Ducted/Non-Ducted) *4			3.60/3.75	3.47/3.70	3.45/3.66	3.43/3.52	3.41/3.51	

Notes:

- *1 Rating Conditions:
Cooling | Indoor: 80°F (26.7°C) DB/67°F (19°C) WB; Outdoor: 95°F (35°C) DB.
Heating | Indoor: 70°F (21.1°C) DB; Outdoor: 47°F (8.3°C) DB/43°F (6°C) WB.
- *2 Twinning Kit is required for combining two or three individual outdoor units in the field for PUHY-P(T)YSLMU combined systems.
- *3 Each individual outdoor unit requires a separate electrical connection. Reference electrical data for each individual outdoor unit.
- *4 Efficiency values based on AHRI 1230 test method.

** Extended ambient cooling operation range down to -10° F DB Low Ambient Kit required.
-BS indicates Seacoast Protection option.

LIMITED WARRANTY | Seven-year warranty on compressor. One-year warranty on parts.
See our website for details on specific additional application installation coverage.
Specifications are subject to change.



SPECIFICATIONS: K-GENERATION R2-SERIES ▼

PURY-P***T(Y)SKMU-A

Model Name		208V /230V	PURY-P72TKMU-A (-BS)	PURY-P96TKMU-A (-BS)	PURY-P120TKMU-A (-BS)	PURY-P144TKMU-A (-BS)
		460V	PURY-P72YKMU-A (-BS)	PURY-P96YKMU-A (-BS)	PURY-P120YKMU-A (-BS)	PURY-P144YKMU-A (-BS)
Power Source		208/230V, 3-Phase, 60Hz/460V, 3-Phase, 60Hz				
Capacity (Nominal) *1	Cooling	Btu/h Capacity	72,000	96,000	120,000	144,000
		kW Power Input	4.4	7.05	9.44	11.2
		A Current Input	13.5/12.2/6.1	21.7/19.6/9.8	29.1/26.3/13.1	34.5/31.2/15.6
	Heating	Btu/h Capacity	80,000	108,000	135,000	160,000
		kW Power Input	5.92	8.28	10.86	13.54
		A Current Input	18.2/16.5/8.2	25.5/23.0/11.5	33.4/30.7/15.1	41.7/37.7/18.8
Electrical Supply	MCA	A	23/21/11	34/31/15	45/42/21	53/48/24
	Recommended Fuse Size	A	25/15	35/20	50/25	60/25
Fan	Type X Quantity		Propeller Fan x 1		Propeller Fan x 2	
	Airflow Rate	CFM	6,200		11,300	11,300
	External Static Pressure		Selectable; 0, 0.12 or 0.24"W.G.; factory set to 0"W.G.			
Compressor	Type X Quantity		INVERTER-driven Scroll Hermetic x 1			
	Operating Range		17% to 100%	16% to 100%	15% to 100%	
	Lubricant		MEL32			
Refrigerant	Type		R410A			
External Finish		Precoated galvanized steel sheet (plus powder Coating for -BS type) <Munsell 5Y 8/1 or similar>				
Dimensions H x W x D	Height	In.	64-31/32			
	Width	In.	48-1/16	68-29/32		
	Depth	In.	29-5/32			
Net Weight	Pounds		503/534	538/574	715/743	
Sound Pressure Level (As Measured in an Anechoic Room)	dB(A)		58.0		60.0	61.0
Protection Devices	High Pressure Protection		High pressure sensor, High pressure switch			
	Inverter Circuit (Compressor/Fan)		Over-current protection			
	Fan Motor		Thermal switch			
Refrigerant Pipe Dimensions	Liquid (High Pressure) (Brazed)	In.	5/8	3/4		7/8
	Gas (Low Pressure) (Brazed)	In.	3/4	7/8	1-1/8	
Indoor Unit Connectable	Total Capacity		50% to 150% of outdoor unit capacity			
	Model/Quantity		P06 - P96/1 to 18	P06 - P96/1 to 24	P06 - P96/1 to 30	P06 - P96/1 to 36
Operating Temperature Range	Cooling	D.B.	**Outdoor: 23° to 115° F			
	Heating	W.B.	Outdoor: -13° to 60° F			
Efficiency Ratings *2						
EER (Ducted/Non-Ducted) *2			13.9/15.5	12.2/13.6	11.7/12.2	11.7/12.7
IEER (Ducted/Non-Ducted) *2			21.1/22.1	19.7/20.9	18.6/20.8	18.0/20.9
COP (Ducted/Non-Ducted) *2			3.81/3.72	3.64/3.71	3.45/3.61	3.41/3.28
SCHE (Ducted/Non-Ducted) *2			23.6/24.48	17.4/23.5	16.8/19.7	18.2/20.2

Notes:

*1 Rating Conditions:
 Cooling | Indoor: 80°F (26.7°C) DB/67°F (19°C) WB; Outdoor: 95°F (35°C) DB.
 Heating | Indoor: 70°F (21.1°C) DB; Outdoor: 47°F (8.3°C) DB/43°F (6°C) WB.

*2. Efficiency values based on AHRI 1230 test method.

** Extended ambient cooling operation range down to -10° F DB Low Ambient Kit required.

-BS indicates Seacoast Protection option.

Specifications are subject to change without notice.

LIMITED WARRANTY | Seven-year compressor and one year parts. See our website for details on specific additional application installation coverage.



SPECIFICATIONS: K-GENERATION R2-SERIES ▼

PURY-P***T(Y)SKMU-A

Model Name			208V /230V	PURY-P168TSKMU-A (-BS) *2		PURY-P192TSKMU-A (-BS) *2		PURY-P216TSKMU-A (-BS) *2			
				With 1 PURY-P72TKMU-A (-BS) and 1 PURY-P96TKMU-A (-BS) *3		With 2 PURY-P96TKMU-A (-BS) *3		With 1 PURY-P96TKMU-A (-BS) and 1 PURY-P120TKMU-A (-BS) *3			
Power Source			460V, 3-Phase, 60Hz	208V/230V, 3-Phase, 60Hz/460V, 3-Phase, 60Hz							
				PURY-P144YSKMU-A (-BS) *2		PURY-P168YSKMU-A (-BS) *2		PURY-P192YSKMU-A (-BS) *2		PURY-P216YSKMU-A (-BS) *2	
Capacity (Nominal) *1			With 2 PURY-P72YKMU-A (-BS) *3		With 1 PURY-P72YKMU-A (-BS) and 1 PURY-P96YKMU-A (-BS) *3		With 2 PURY-P96YKMU-A (-BS) *3		With 1 PURY-P96YKMU-A (-BS) and 1 PURY-P120YKMU-A (-BS) *3		
			Capacity (Nominal) *1	Cooling	Btu/h Capacity	144,000	168,000	192,000	216,000		
kW Power Input	10.31	12.8 *3			15.61 *3	18.22 *3					
A Current Input	14.3 *3	39.4/35.7/17.8 *3			48.1/43.5/15.61 *3	56.1/50.8/25.4 *3					
Heating	Btu/h Capacity	160,000		188,000	215,000	243,000					
	kW Power Input	12.54 *3		14.91 *3	17.2 *3	19.89 *3					
	A Current Input	17.4		45.9/41.5/20.7 *3	53.9/47.9/23.9 *3	61.3/55.4/27.7 *3					
Fan	Type X Quantity		Refer to: PURY-P72YKMU-A (-BS)	Refer to: PURY-P72TKMU-A (-BS)/ PURY-P96TKMU-A (-BS)	Refer to: PURY-P96TKMU-A (-BS)	Refer to: PURY-P96YKMU-A (-BS)	Refer to: PURY-P96TKMU-A (-BS)/ PURY-P120TKMU-A (-BS)	Refer to: PURY-P96TKMU-A (-BS)/ PURY-P120TKMU-A (-BS)	Refer to: PURY-P96TKMU-A (-BS)/ PURY-P120TKMU-A (-BS)	Refer to: PURY-P96TKMU-A (-BS)/ PURY-P120TKMU-A (-BS)	
	Airflow Rate	CFM									
	External Static Pressure										
Compressor	Type X Quantity		15% to 100%	7% to 100%	8% to 100%	8% to 100%	Refer to: PURY-P96TKMU-A (-BS)	Refer to: PURY-P96TKMU-A (-BS)	Refer to: PURY-P96TKMU-A (-BS)	Refer to: PURY-P96TKMU-A (-BS)/ PURY-P120TKMU-A (-BS)	
	Operating Range										
	Crankcase Heater	W									
Lubricant			Refer to: PURY-P72YKMU-A (-BS)	Refer to: PURY-P72TKMU-A (-BS) / PURY-P96TKMU-A (-BS)	Refer to: PURY-P96TKMU-A (-BS)	Refer to: PURY-P96YKMU-A (-BS)	Refer to: PURY-P96TKMU-A (-BS)/ PURY-P120TKMU-A (-BS)	Refer to: PURY-P96TKMU-A (-BS)/ PURY-P120TKMU-A (-BS)	Refer to: PURY-P96TKMU-A (-BS)/ PURY-P120TKMU-A (-BS)		
Refrigerant Type											
External Finish											
Dimensions H x W x D	Height	In.	Refer to: PURY-P72YKMU-A (-BS)	Refer to: PURY-P72TKMU-A (-BS) / PURY-P96TKMU-A (-BS)	Refer to: PURY-P96TKMU-A (-BS)	Refer to: PURY-P96YKMU-A (-BS)	Refer to: PURY-P96TKMU-A (-BS)/ PURY-P120TKMU-A (-BS)	Refer to: PURY-P96TKMU-A (-BS)/ PURY-P120TKMU-A (-BS)	Refer to: PURY-P96TKMU-A (-BS)/ PURY-P120TKMU-A (-BS)		
	Width	In.									
	Depth	In.									
Net Weight		Pounds	61.0	61.0	61.0	61.0	61.0	61.0	61.0		
Sound Pressure Level (As Measured in an Anechoic Room)		dB(A)									
Protection Devices											
Protection Devices	High Pressure Protection		High pressure sensor, High pressure switch								
	Inverter Circuit (Compressor/Fan)		Over-current protection								
	Fan Motor		Thermal switch								
Refrigerant Pipe Dimensions	Liquid (High Pressure) (Braze)	In.	7/8					1-1/8			
	Gas (Low Pressure) (Braze)	In.	1-1/8								
Indoor Unit Connectable	Total Capacity		50% to 150% of outdoor unit capacity								
	Model/Quantity		P06-P96/1 to 36	P06-P96/1 to 42	P06-P96/1 to 48	P06-P96/2 to 50 *4					
Operating Temperature Range	Cooling	D.B.	**Outdoor: 23° to 115° F								
	Heating	W.B.	Outdoor: -13° to 60° F								
Efficiency Ratings *5											
EER (Ducted/Non-Ducted) *5			12.0/14.4	12.1/12.9	11.6/11.9	11.4/11.3					
IEER (Ducted/Non-Ducted) *5			18.8/20.6	19.4/19.1	19.3/18.2	18.7/18.3					
COP (Ducted/Non-Ducted) *5			3.54/3.65	3.63/3.52	3.64/3.47	3.54/3.43					
SCHE (Ducted/Non-Ducted) *5			21.8/24.0	20.0/22.6	17.4/21.81	17.1/20.11					

Notes:

*1 Rating Conditions:

Cooling | Indoor: 80°F (26.7°C) DB/67°F (19°C) WB; Outdoor: 95°F (35°C) DB.
Heating | Indoor: 70°F (21.1°C) DB; Outdoor: 47°F (8.3°C) DB/43°F (6°C) WB.

*2 Twinning Kit is required for combining two individual outdoor units in the field for PURY-P-T(Y)SKMU combined systems.

*3 Each individual outdoor unit requires a separate electrical connection.

Reference electrical data for each individual outdoor unit.

*4 Maximum connectable number of branch pipes is 48.

*5 Efficiency values based on AHRI 1230 test method.

** Extended ambient cooling operation range down to -10° F DB Low Ambient Kit required.

In systems with considerably long piping runs, the outdoor units may exhibit slightly louder than normal sound pressure levels when in heating mode.

The outdoor twinning kit (low pressure) should be connected to the low pressure side of the outdoor unit. If the connected units are different capacities, the outdoor twinning kit (low pressure) should be installed in the unit with the largest capacity.

-BS indicates Seacoast Protection option.

Specifications are subject to change without notice.

LIMITED WARRANTY | Seven-year compressor and one year parts. See our website for details on specific additional application installation coverage.



SPECIFICATIONS: K-GENERATION R2-SERIES ▼

PURY-P***T(Y)SKMU-A

Model Name		208V /230V	PURY-P240TSKMU-A (-BS) *2	PURY-P264TKMU-A (-BS) *2	PURY-P288TSKMU-A (-BS) *2	
		460V	With 2 PURY-P120TKMU-A (-BS) *3	With 1 PURY-P120TKMU-A (-BS) and 1 PURY-P144TKMU-A (-BS) *3	With 2 PURY-P144TKMU-A (-BS) *3	
Power Source		208/230V 3-Phase, 60Hz/460V, 3-Phase, 60Hz				
Capacity (Nominal) *1	Cooling	Btu/h Capacity	240,000	264,000	288,000	
	Heating	Btu/h Capacity	270,000	295,000	320,000	
Fan	Type X Quantity		Refer to: PURY-P120TKMU-A (-BS) PURY-P120YKMU-A (-BS)	Refer to: PURY-P120TKMU-A (-BS)/ PURY-P144TKMU-A (-BS) PURY-P120YKMU-A (-BS)/ PURY-P144YKMU-A (-BS)	Refer to: PURY-P144TKMU-A (-BS) PURY-P144YKMU-A (-BS)	
	Airflow Rate	CFM				
	External Static Pressure					
Compressor	Type X Quantity		Refer to: PURY-P120TKMU-A (-BS) PURY-P120YKMU-A (-BS)	Refer to: PURY-P120TKMU-A (-BS)/ PURY-P144TKMU-A (-BS) PURY-P120YKMU-A (-BS)/ PURY-P144YKMU-A (-BS)	Refer to: PURY-P144TKMU-A (-BS) PURY-P144YKMU-A (-BS)	
	Operating Range					7% to 100%
	Crankcase Heater	W				
Lubricant						
Refrigerant	Type		PURY-P120YKMU-A (-BS)	PURY-P120YKMU-A (-BS)/ PURY-P144YKMU-A (-BS)	PURY-P144YKMU-A (-BS)	
External Finish						
Dimensions H x W x D	Height	In.				
	Width	In.				
	Depth	In.				
Net Weight		Pounds				
Sound Pressure Level (As Measured in an Anechoic Room)		dB(A)	63.0	63.5	64.0	
Protection Devices	High Pressure Protection		High pressure sensor, High pressure switch			
	Inverter Circuit (Compressor/Fan)		Over-current protection			
Refrigerant Pipe Dimensions	Liquid (High Pressure) (Brazed)	In.	1-1/8			
	Gas (Low Pressure) (Brazed)	In.	1-3/8			
Indoor Unit Connectable	Total Capacity		50% to 150% of outdoor unit capacity			
	Model/Quantity		P06-P96/2 to 50 *4			
Operating Temperature Range	Cooling	D.B.	**Outdoor: 23° to 115° F			
	Heating	W.B.	Outdoor: -13° to 60° F			
Efficiency Ratings* 5						
EER (Ducted/Non-Ducted) *5		10.9/10.9		11.0/11.0	11.2/11.3	
IEER (Ducted/Non-Ducted) *5		17.8/18.5		17.7/18.4	17.6/18.6	
COP (Ducted/Non-Ducted) *5		3.38/3.42		3.4/3.25	3.41/3.20	
SCHE (Ducted/Non-Ducted) *5		16.5/18.6		17.3/18.7	18.2/19.0	

Notes:

- *1 Rating Conditions:
Cooling | Indoor: 80°F (26.7°C) DB/67°F (19°C) WB; Outdoor: 95°F (35°C) DB.
Heating | Indoor: 70°F (21.1°C) DB; Outdoor: 47°F (8.3°C) DB/43°F (6°C) WB.
- *2 Twinning Kit is required for combining two individual outdoor units in the field for PURY-P-T(Y)SKMU combined systems.
- *3 Each individual outdoor unit requires a separate electrical connection. Reference electrical data for each individual outdoor unit.
- *4 Maximum connectable no. of branch pipes is 48.
- *5 Efficiency values based on AHRI 1230 test method.
- * 264 and 288 require use -HA, BC controller
- ** Extended ambient cooling operation range down to -10° F DB Low Ambient Kit required.

Notes:

- In systems with considerably long piping runs, the outdoor units may exhibit slightly louder than normal sound pressure levels when in heating mode.
- The outdoor twinning kit (low pressure) should be connected to the low pressure side of the outdoor unit. If the connected units are different capacities, the outdoor twinning kit (low pressure) should be installed in the unit with the largest capacity.
- BS indicates Seacoast Protection option.

Specifications are subject to change without notice.

LIMITED WARRANTY | Seven-year compressor and one year parts. See our website for details on specific additional application installation coverage.

PURY-HP***T(S)KMU-A

Model Name		208/230V	PURY-HP72TKMU-H-A	PURY-HP96TKMU-H-A	PURY-HP144TSKMU-H-A *2 With 2 PURY-HP72TKMU-H-A *3	PURY-HP192TSKMU-H-A *2 With 2 PURY-HP96TKMU-H-A *3
		460V	PURY-HP72YKMU-A	PURY-HP96YKMU-A	PURY-HP144YSKMU-A *2 With 2 PURY-HP72YKMU-A *3	PURY-HP192YSKMU-A *2 With 2 PURY-HP96YKMU-A *3
Electrical Power Requirements	Voltage, Phase, Hertz	208/230V, 3-phase, 60Hz 460V, 3-phase, 60Hz				
Nominal Cooling	Capacity *1	Btu/h	72,000	96,000	144,000	192,000
Nominal Heating	Capacity *1	Btu/h	80,000	108,000	160,000	215,000
Electrical Supply	MCA	A	44/40 26	60/54 32	Refer to: PURY-HP72TKMU-H-A PURY-HP72YKMU-A	Refer to: PURY-HP96TKMU-H-A PURY-HP96YKMU-A
	Recommended Fuse/Breaker Size	A	50 30	65 35		
	Maximum Fuse Size	A	60 30	80 35		
Fan	Type x Quantity	Propeller Fan x 1				
	Airflow Rate	CFM	6,200			
Compressor	Operating Range	Cooling	30% to 100%	23% to 100%	15% to 100%;	12% to 100%;
		Heating	15% to 100%	13% to 100%	7% to 100%	6% to 100%
	Type x Quantity	Inverter-driven Scroll Hermetic x 1				
	Lubricant	MEL32				
Refrigerant	Type	R410A				
External Finish	Precoated galvanized steel sheet					
Dimensions	Height	In.	64-31/32			
	Width		48-1/16			
	Depth		29-5/32			
Net Weight	Lbs.	552 574	552 576			
Sound Pressure Levels	dB(A)	58			61	
Protection Devices	High-pressure	High pressure sensor, High pressure switch at 4.15 MPa (601 psi)				
	Inverter circuit (COMP./FAN)	Over-current protection				
Refrigerant Pipe Dimensions	Liquid (High Pressure) (Brazed)	In.	5/8	3/4	7/8	
	Gas (Low Pressure) (Brazed)		3/4	7/8	1-1/8	
Indoor Unit Connectable	Total Capacity	50 to 150% of Outdoor Unit Capacity				
	Model/Quantity *4	P06 to P96/1 to 18	P06 to P96/1 to 24	P06 ~ P96/1 to 36	P06 ~ P96/1 to 48	
Operating Temperature Range	Cooling (Outdoor) **	23 ~ 115° F (-5 ~ +46° C) D.B.				
	Heating (Outdoor)	-13 ~ +60° F (-25 ~ +15.5° C) W.B.				
Efficiency Ratings (Ducted/Non-Ducted) *5	EER	12.9/13.0	11.4/12.5	12.5/12.6	11.1/12.1	
	IEER	17.2/18.4	16.5/17.1	16.7/17.9	16.1/16.6	
	COP	3.61/3.55	3.46/3.44	3.47/3.41	3.32/3.31	
	SCHE *2	22.7/22.6	17.4/22.0	22.1/22.0	16.9/21.4	

Notes:

- *1 Rating Conditions:
Cooling | Indoor: 80°F (26.7°C) DB/67°F (19°C) WB; Outdoor: 95°F (35°C) DB.
Heating | Indoor: 70°F (21.1°C) DB; Outdoor: 47°F (8.3°C) DB/43°F (6°C) WB.
- *2 Twinning Kit is required for combining two individual outdoor units in the field for PURY-HP-T(Y)SKMU combined systems.
- *3 Each individual outdoor unit requires a separate electrical connection. Reference electrical data for each individual outdoor unit.
- *4 Maximum connectable number of branch pipes is 48.
- *5 Efficiency values based on AHRI 1230 test method.
- ** Low Ambient Kit is required for extended ambient cooling operation range down to -10° F DB.

In systems with considerably long piping runs, the outdoor units may exhibit slightly louder than normal sound pressure levels when in heating mode.

The outdoor twinning kit (low pressure) should be connected to the low pressure side of the outdoor unit. If the connected units are different capacities, the outdoor twinning kit (low pressure) should be installed in the unit with the largest capacity.

Specifications are subject to change without notice.

LIMITED WARRANTY | Seven-year compressor and one year parts. Extended warranty of up to 10 years is available. See our website for details on specific additional application installation coverage.

SPECIFICATIONS: BC CONTROLLER ▼

CMB-P-NU-G1 (Single BC)

Model Name			CMB-P105NU-G1	CMB-P106NU-G1	CMB-P108NU-G1	CMB-P1010NU-G1	CMB-P1013NU-G1	CMB-P1016NU-G1	
Number of Branches			5	6	8	10	13	16	
Power Source			208/230V, 1-phase, 60 Hz						
Power Input	Cooling	W	73	86	112	138	178	217	
	Heating	W	33	40	53	66	86	106	
Current (208/230V)	Cooling	A	0.35/0.32	0.41/0.37	0.54/0.49	0.66/0.60	0.86/0.77	1.04/0.94	
	Heating	A	0.16/0.14	0.19/0.17	0.25/0.23	0.32/0.29	0.41/0.37	0.51/0.46	
External Finish			Unit: Galvanized steel plate; Drain pan: Precoated galvanized sheets plus powder coating						
Dimensions	Height	Inches	11-3/16						
	Width	Inches	25-17/32				43-1/4		
	Depth	Inches	17-1/32						
Net Weight			Pounds	72	76	84	94	126	138
Refrigerant Pipe Dimensions	To Indoor Unit *1	Liquid Pipe (In.)	3/8 Brazed						
		Gas Pipe (In.)	5/8 (Brazed)						
Max. Connected Capacity for All Branches			Btu/h	189,000	189,000	189,000	189,000	189,000	189,000
Indoor Unit Capacity Connectable to One Branch			54,000 Btu/h or less per branch						
Drain Pipe			O.D. 1-1/4"						

Notes:

*1 BC controller includes reducers for all branches. 5/8" flare to 1/2" braze, 3/8" flare to 1/4" braze.

Specifications are subject to change without notice.

CMB-P-NU-GA1/HA1 (Main BC)

Model Name			CMB-P1013NU-GA1	CMB-P108NU-HA1	CMB-P1010NU-HA1	CMB-P1016NU-HA1	
Number of Branches			13	8	10	16	
Power Source			208/230V, 1-phase, 60 Hz				
Power Input	Cooling	W	178	152/196	183/236	274/353	
	Heating	W	86	76/98	92/118	137/177	
Current (208/230V)	Cooling	A	0.86/0.77	0.074/0.086	0.88/1.03	1.32/1.54	
	Heating	A	0.41/0.37	0.37/0.43	0.45/0.52	0.66/0.77	
External Finish			Unit: Galvanized steel plate; Drain pan: Precoated galvanized sheets plus powder coating				
Dimensions	Height	Inches	11-13/32	11-7/16			
	Width	Inches	43-3/4				
	Depth	Inches	20-1/2				
Net Weight			Pounds	148	124	131	172
Refrigerant Pipe Dimensions	To Indoor Unit *1	Liquid Pipe (In.)	3/8 Brazed				
		Gas Pipe (In.)	5/8 (Brazed)				
Max. connected capacity for all branches			Btu/h	360,000	360,000	360,000	432,000
Max. Connected Capacity to Sub BC Controller(s) *2			Btu/h	126,000	126,000	126,000	126,000
Indoor Unit Capacity Connectable to One Branch			54,000 Btu/h or less per branch				
Drain Pipe			O.D. 1-1/4"				

Notes:

*1 BC controller includes reducers for all branches. 5/8" flare to 1/2" braze, 3/8" flare to 1/4" braze.

*2 If two sub BC controllers are connected and at least one is a CMB-P1016NU-HB, the maximum connected capacity is 168,000 Btu/h.

Specifications are subject to change without notice.

CMB-P-NU-GB1/HB1 (Sub BC)

Model Name			CMB-P104NU-GB1	CMB-P108NU-GB1	CMB-P1016NU-HB1
Number of Branches			4	8	16
Power Source			208/230V, 1-phase, 60 Hz		
Power Input	Cooling	W	53	106	314
	Heating	W	27	53	157
Current (208/230V)	Cooling	A	0.25/0.23	0.51/0.46	1.17/1.37
	Heating	A	0.13/0.12	0.25/0.23	0.59/0.69
External Finish			Unit: Galvanized steel plate; Drain pan: Precoated galvanized sheets plus powder coating		
Dimensions	Height	Inches	11-3/16		
	Width	Inches	25-17/32		43-1/4
	Depth	Inches	17-1/32		
Net Weight		Pounds	62	82	136
Refrigerant Pipe Dimensions	To Indoor Unit *1	Liquid Pipe (In.)	3/8 Brazed		
		Gas Pipe (In.)	5/8 Brazed		
Max. Connected Capacity for All Branches		Btu/h	126,000	126,000	126,000
Indoor Unit Capacity Connectable to One Branch			54,000 Btu/h or less per branch		
Drain Pipe			O.D. 1-1/4"		

Notes:

*1 BC controller includes reducers for all branches. 5/8" flare to 1/2" braze, 3/8" flare to 1/4" braze.

Specifications are subject to change without notice.

Refrigerant Line Sizes from Main BC Controller to Sub BC Controller(s)

	Liquid (High Pressure)	Gas (Low Pressure)	Liquid Pipe
Total downstream capacity < 72,000 Btu/h (nominal cooling capacity)	5/8" (Brazed)	3/4" (Brazed)	3/8" (Brazed)
Total downstream capacity between 73,000 – 108,000 Btu/h (nominal cooling capacity)	3/4" (Brazed)	7/8" (Brazed)	3/8" (Brazed)
Total downstream capacity between 109,000 – 126,000 Btu/h (nominal cooling capacity)	3/4" (Brazed)	1-1/8" (Brazed)	1/2" (Brazed)
Total downstream capacity between 127,000 – 144,000 Btu/h (nominal cooling capacity)	7/8" (Brazed)	1-1/8" (Brazed)	1/2" (Brazed)
Total downstream capacity between 145,000 – 168,000 Btu/h (nominal cooling capacity)	7/8" (Brazed)	1-1/8" (Brazed)	5/8" (Brazed)

Specifications are subject to change without notice.

DIAMONDBACK™ BV-Series Ball Valves



Model numbers:

BV14BBSI/ BV38BBSI/ BV12BBSI/ BV58BBSI

- Size available: 1/4", 1/2", 3/8"; 5/8".
- Fully factory assembled.
- Furnace brazed and pressure tested.
- Each ball valve is equipped with 1/4" Schrader® Valve for refrigerant service.
- Design working pressure: 700 PSIG.
- Temperature range: -40° F to +325° F (-40° C to +149° C).
- Forged and machined brass unibody designed with forged brass seal cap.
- Polytetrafluoroethylene (PTFE) seals and gaskets (no synthetic O-rings).
- Seal cap design permits valve operation without removal of seal cap.
- One year limited materials and workmanship warranty on Ball Valves.



- Full Port Design.
- 800 PSIG Rated.
- R-410A Compatible.
- Brazed Connections.



*Ball valves come with an insulation piece.

Part Number	SAE Braze	A	B	C	D	E
BV14BBSI	1/4"	6.5	3.06	1.81	1.81	1.42
BV38BBSI	3/8"	6.5	3.06	1.81	1.81	1.42
BV12BBSI	1/2"	6.5	3.06	1.81	1.81	1.42
BV58BBSI	5/8"	6.5	3.06	1.81	1.81	1.42

Schrader® is a registered trademark of Schrader-Bridgeport Inc.



SPECIFICATIONS: K-GENERATION Y-SERIES ▼

PUHY-P**T(Y)SKMU-A

Model Name			208V/ 230V	PUHY-P72TKMU-A (-BS)	PUHY-P96TKMU-A (-BS)	PUHY-P120TKMU-A (-BS)	PUHY-P144TKMU-A (-BS)
			460V	PUHY-P72YKMU-A (-BS)	PUHY-P96YKMU-A (-BS)	PUHY-P120YKMU-A (-BS)	PUHY-P144YKMU-A (-BS)
Power Source			208/230V, 3-Phase, 60Hz 460V, 3-Phase, 60Hz				
Capacity (Nominal) *1	Cooling	Btu/h Capacity	72,000	96,000	120,000	144,000	
	Heating	Btu/h Capacity	80,000	108,000	135,000	160,000	
Electrical Supply	MCA	A	25/23 12	34/31 15	45/42 20	53/49 24	
	Recommended Fuse Size	A	30 15	35 20	50 25	60 25	
Fan	Type X Quantity		Propeller Fan x 1		Propeller Fan x 2		
	Airflow Rate	CFM	6,200			11,300	
	External Static Pressure		Selectable; 0, 0.12 or 0.24" W.G.; factory set to 0" W.G.				
Compressor	Type X Quantity		INVERTER-driven Scroll Hermetic x 1				
	Operating Range		15% to 100%	16% to 100%	15% to 100%	14% to 100%	
	Lubricant		MEL32				
Refrigerant	Type		R410A				
External Finish			Precoated galvanized steel sheet (plus powder Coating for -BS type) <Munsell 5Y 8/1 or Similar>				
Dimensions H X W X D	Height	In.	64-31/32				
	Width	In.	36-1/4	48-1/16	68-29/32		
	Depth	In.	29-5/32				
Net Weight		Pounds	430 463	532 558	697 726		
Sound Pressure Level (As Measured in an Anechoic Room)		dB(A)	58.0	58.0	60.0	61.0	
Protection Devices	High Pressure Protection		High pressure sensor, High pressure switch				
	Inverter Circuit (Compressor/Fan)		Over-current protection				
	Fan Motor		Thermal switch				
Refrigerant Pipe Dimensions	Liquid (High Pressure) (Brazed)	In.	3/8	3/8 (1/2", length to first joint ≥ 295')	3/8 (1/2", length to first joint ≥ 131')	1/2	
	Gas (Low Pressure) (Brazed)	In.	7/8		1-1/8		
Indoor Unit Connectable	Total Capacity		50% to 130% of outdoor unit capacity				
	Model/Quantity		P06 - P96/1 to 15	P06 - P96/1 to 20	P06 - P96/1 to 26	P06 - P96/1 to 31	
Operating Temperature Range	Cooling	D.B.	**Outdoor: 23° to 115° F				
	Heating	W.B.	Outdoor: -13° to 60° F				
Efficiency Ratings (Ducted/ Non-Ducted) *2	EER		13.0/14.2	12.6/13.7	12.5/12.7	11.6/11.8	
	IEER		19.8/21.3	19.7/20.7	19.1/19.1	19.3/20.2	
	COP		3.83/4.19	3.95/4.22	3.66/3.83	3.56/3.72	

Notes:

*1 Rating Conditions:

Cooling | Indoor: 80°F (26.7°C) DB/67°F (19°C) WB; Outdoor: 95°F (35°C) DB.

Heating | Indoor: 70°F (21.1°C) DB; Outdoor: 47°F (8.3°C) DB/43°F (6°C) WB.

*2 Efficiency values based on AHRI 1230 test method.

** Low Ambient Kit is required for extended ambient cooling operation range down to -10° F DB.

-BS indicates Seacoast Protection option.

Specifications are subject to change without notice.

LIMITED WARRANTY | Seven-year compressor and one year parts. Extended warranty of up to 10 years is available. See our website for details on specific additional application installation coverage.



SPECIFICATIONS: K-GENERATION Y-SERIES ▼

PUHY-P**T(Y)SKMU-A

Model Name	208V/230V		PUHY-P168TSKMU-A (-BS) *2	PUHY-P192TSKMU-A (-BS) *2	PUHY-P216TSKMU-A (-BS) *2	PUHY-P240TSKMU-A (-BS) *2	
	460V		With 1 PUHY-P72TKMU-A (-BS) and 1 PUHY-P96TKMU-A (-BS) *3	With 1 PUHY-P72TKMU-A (-BS) and 1 PUHY-P120TKMU-A (-BS)	With 1 PUHY-P96TKMU-A (-BS) and 1 PUHY-P120TKMU-A (-BS) *3	With 2 PUHY-P120TKMU-A (-BS) *3	
	PUHY-P144YSKMU-A (-BS) *2		PUHY-P168YSKMU-A (-BS) *2	PUHY-P192YSKMU-A (-BS) *2	PUHY-P216YSKMU-A (-BS) *2	PUHY-P240YSKMU-A (-BS) *2	
Power Source		460V, 3-Phase, 60Hz		208/230V, 3-Phase, 60Hz 460V, 3-Phase, 60Hz			
Capacity (Nominal) *1	Cooling	Btu/h Capacity	144,000	168,000	192,000	216,000	240,000
	Heating	Btu/h Capacity	160,000	188,000	215,000	243,000	270,000
Fan	Type X Quantity		Refer to: PUHY-P72YKMU-A (-BS)	Refer to: PUHY-P72TKMU-A (-BS)/ PUHY-P96TKMU-A (-BS) PUHY-P72YKMU-A (-BS)/ PUHY-P96YKMU-A (-BS)	Refer to: PUHY-P72TKMU-A (-BS)/ PUHY-P120TKMU-A (-BS)	Refer to: PUHY-P96TKMU-A (-BS)/ PUHY-P120TKMU-A (-BS) PUHY-P96YKMU-A (-BS)/ PUHY-P120YKMU-A (-BS)	Refer to: PUHY-P120TKMU-A (-BS) PUHY-P120YKMU-A (-BS)
	Airflow Rate	CFM					
	External Static Pressure						
Compressor	Type X Quantity		9% to 100%	6% to 100%	6% to 100%	8% to 100%	8% to 100%
	Operating Range	W	Refer to: PUHY-P72YKMU-A (-BS)	Refer to: PUHY-P72TKMU-A (-BS)/ PUHY-P96TKMU-A (-BS)	Refer to: PUHY-P72TKMU-A (-BS)/ PUHY-P120TKMU-A (-BS)	Refer to: PUHY-P96TKMU-A (-BS)/ PUHY-P120TKMU-A (-BS)	Refer to: PUHY-P120TKMU-A (-BS)
	Crankcase Heater						
Lubricant							
Refrigerant	Type						
External Finish						PUHY-P96YKMU-A (-BS)/ PUHY-P120YKMU-A (-BS)	PUHY-P120YKMU-A (-BS)
Dimensions H X W X D	Height	In.					
	Width	In.					
	Depth	In.					
Net Weight	Pounds						
Sound Pressure Level (As Measured in an Anechoic Room)	dB(A)		61.0	61.0	62.5	62.5	63.0
Protection Devices	High Pressure Protection		High pressure sensor, High pressure switch				
	Inverter Circuit (Compressor/Fan)		Over-current protection				
	Fan Motor		Thermal switch				
Refrigerant Pipe Dimensions	Liquid (High Pressure) (Braze)	In.	1/2	5/8			
	Gas (Low Pressure) (Braze)	In.	1-1/8				
Indoor Unit Connectable	Total Capacity		50% to 130% of outdoor unit capacity				
	Model/Quantity		P06 - P96/1 to 31	P06 - P96/1 to 36	P06 - P96/1 to 41	P06 - P96/2 to 46	P06 - P96/2 to 50
Operating Temperature Range	Cooling	D.B.	**Outdoor: 23 to 115° F				
	Heating	W.B.	Outdoor: -13 to 60° F				
Efficiency Ratings (Ducted/ Non-Ducted) *4	EER		12.8/13.2	12.6/12.9	12.4/12.5	12.3/12.3	12.1/12.0
	IEER		19.3/20.3	19.6/19.7	18.9/19.1	18.9/18.6	18.6/18.1
	COP		3.79/3.95	3.78/3.83	3.63/3.61	3.65/3.56	3.55/3.53

Notes:

- *1 Rating Conditions:
Cooling | Indoor: 80°F (26.7°C) DB/67°F (19°C) WB; Outdoor: 95°F (35°C) DB.
Heating | Indoor: 70°F (21.1°C) DB; Outdoor: 47°F (8.3°C) DB/43°F (6°C) WB.
- *2 Twinning Kit is required for combining two or three individual outdoor units in the field for PUHY-P(T)YSKMU combined systems.
- *3 Each individual outdoor unit requires a separate electrical connection. Reference electrical data for each individual outdoor unit.
- *4 Efficiency values based on AHRI 1230 test method.

** Low Ambient Kit is required for extended ambient cooling operation range down to -10° F DB.

-BS indicates Seacoast Protection option.

Specifications are subject to change without notice.

LIMITED WARRANTY | Seven-year compressor and one year parts. Extended warranty of up to 10 years is available. See our website for details on specific additional application installation coverage.



SPECIFICATIONS: K-GENERATION Y-SERIES ▼

PUHY-P**T(Y)SKMU-A

Model Name		208V/230V		PUHY-P264TSKMU-A (-BS) *2	PUHY-P288TSKMU-A (-BS) *2	PUHY-P312TSKMU-A (-BS) *2	PUHY-P336TSKMU-A (-BS) *2	PUHY-P360TSKMU-A (-BS) *2
		460V		With 2 PUHY-P72TKMU-A (-BS) and 1 PUHY-P120TKMU-A (-BS) *3	With 1 PUHY-P72TKMU-A (-BS) and 1 PUHY-P96TKMU-A (-BS) and PUHY-P120TKMU-A (-BS) *3	With 1 PUHY-P72TKMU-A (-BS) and 2 PUHY-P120TKMU-A (-BS) *3	With 1 PUHY-P96TKMU-A (-BS) and 2 PUHY-P120TKMU-A (-BS) *3	With 3 PUHY-P120TKMU-A (-BS) *3
Power Source		208/230V, 3-Phase, 60Hz 460V, 3-Phase, 60Hz						
Capacity (Nominal) *1	Cooling	Btu/h Capacity	264,000	288,000	312,000	336,000	360,000	
	Heating	Btu/h Capacity	295,000	323,000	350,000	378,000	405,000	
Fan	Type X Quantity		Refer to: PUHY-P72TKMU-A (-BS)/ PUHY-P120TKMU-A (-BS)	Refer to: PUHY-P72TKMU-A (-BS)/ PUHY-P96TKMU-A (-BS)/ PUHY-P120TKMU-A (-BS)	Refer to: PUHY-P72TKMU-A (-BS)/ PUHY-P120TKMU-A (-BS)	Refer to: PUHY-P96TKMU-A (-BS)/ PUHY-P120TKMU-A (-BS)	Refer to: PUHY-P120TKMU-A (-BS)	
	Airflow Rate	CFM						
Compressor	External Static Pressure		PUHY-P72YKMU-A (-BS)/ PUHY-P120YKMU-A (-BS)	PUHY-P72YKMU-A (-BS)/ PUHY-P96YKMU-A (-BS)/ PUHY-P120YKMU-A (-BS)	PUHY-P72YKMU-A (-BS)/ PUHY-P120YKMU-A (-BS)	PUHY-P96YKMU-A (-BS)/ PUHY-P120YKMU-A (-BS)	PUHY-P120YKMU-A (-BS)	
	Type X Quantity		5% to 100%	4% to 100%	4% to 100%	5% to 100%	5% to 100%	
Refrigerant	Operating Range	W	Refer to: PUHY-P72TKMU-A (-BS)/ PUHY-P120TKMU-A (-BS)	Refer to: PUHY-P72TKMU-A (-BS)/ PUHY-P96TKMU-A (-BS)/ PUHY-P120TKMU-A (-BS)	Refer to: PUHY-P72TKMU-A (-BS)/ PUHY-P120TKMU-A (-BS)	Refer to: PUHY-P96TKMU-A (-BS)/ PUHY-P120TKMU-A (-BS)	Refer to: PUHY-P120TKMU-A (-BS)	
	Crankcase Heater	Lubricant						
External Finish		Type						
Dimensions H X W X D	Height	In.	PUHY-P72YKMU-A (-BS)/ PUHY-P120YKMU-A (-BS)	PUHY-P72YKMU-A (-BS)/ PUHY-P96YKMU-A (-BS)/ PUHY-P120YKMU-A (-BS)	PUHY-P72YKMU-A (-BS)/ PUHY-P120YKMU-A (-BS)	PUHY-P96YKMU-A (-BS)/ PUHY-P120YKMU-A (-BS)	PUHY-P120YKMU-A (-BS)	
	Width	In.						
	Depth	In.						
Net Weight		Pounds						
Sound Pressure Level (As Measured in an Anechoic Room)		dB(A)	63.5	64.0	64.5		65.0	
Protection Devices	High Pressure Protection		High pressure sensor, High pressure switch					
	Inverter Circuit (Compressor/Fan)		Over-current protection					
	Fan Motor		Thermal switch					
Refrigerant Pipe Dimensions	Liquid (High Pressure) (Brazed)	In.	3/4					
	Gas (Low Pressure) (Brazed)	In.	1-3/8		1-5/8			
Indoor Unit Connectable	Total Capacity		50 to 130% of outdoor unit capacity					
	Model/Quantity		P06 - P96/2 to 50					
Operating Temperature Range	Cooling	D.B.	*Outdoor: 23° to 115° F					
	Heating	W.B.	Outdoor: -13° to 60° F					
Efficiency Ratings (Ducted/Non-Ducted) *4	EER		12.5/12.5	12.4/12.4	12.1/12.1	11.9/12.0	11.7/11.8	
	IEER		19.0/18.7	19.0/18.7	18.4/18.1	18.2/17.8	17.8/17.2	
	COP		3.68/3.6	3.68/3.59	3.54/3.45	3.5/3.36	3.39/3.22	

Notes:

*1 Rating Conditions:

Cooling | Indoor: 80°F (26.7°C) DB/67°F (19°C) WB; Outdoor: 95°F (35°C) DB.
Heating | Indoor: 70°F (21.1°C) DB; Outdoor: 47°F (8.3°C) DB/43°F (6°C) WB.

*2 Twinning Kit is required for combining two or three individual outdoor units in the field for PUHY-P(T)YSKMU combined systems.

*3 Each individual outdoor unit requires a separate electrical connection. Reference electrical data for each individual outdoor unit.

*4 Efficiency values based on AHRI 1230 test method.

** Low Ambient Kit is required for extended ambient cooling operation range down to -10° F DB.

-BS indicates Seacoast Protection option.

Specifications are subject to change without notice.

LIMITED WARRANTY | Seven-year compressor and one year parts. Extended warranty of up to 10 years is available. See our website for details on specific additional application installation coverage.



SPECIFICATIONS: K-GENERATION H2i® Y-SERIES ▼

PUHY-HP**T(S)JMU-A

Model Name			PUHY-HP72TJMU-A (-BS)	PUHY-HP96TJMU-A (-BS)	PUHY-HP144TSJMU-A (-BS) *2	PUHY-HP192TSJMU-A (-BS) *2
					With 2 PUHY-HP72TJMU-A (-BS)	With 2 PUHY-HP96TJMU-A (BS)
Power Source			208/230V, 3-Phase, 60Hz			
Capacity *1	Cooling	Btu/h	72,000	96,000	144,000	192,000
	Heating	Btu/h	80,000	108,000	160,000	216,000
Electrical Supply	MCA	A	59/54	74/68	59 + 59/54 + 54 *3	74 + 74/68 + 68 *3
	Recommended Fuse/Breaker Size	A	60/60	75/75	60 + 60 *3	75 + 75 *3
	Maximum Fuse Size	A	100/90	120/110	100 + 100/90 + 90 *3	120 + 120/110 + 110 *3
Fan	Type x Quantity		Propeller Fan x 1		Refer to PUHY-HP72TJMU (-BS) Specifications	Refer to PUHY-HP96TJMU (-BS) Specifications
	Airflow Rate	CFM	6,180	7,950		
	Motor Output	kW	0.92			
Compressor	Operating Range	Cooling	30% to 100%	23% to 100%	15% to 100%	12% to 100%
		Heating	16% to 100%	13% to 100%	8% to 100%	6% to 100%
	Type		Inverter Scroll Hermetic		Refer to PUHY-HP72TJMU (-BS) Specifications	Refer to PUHY-HP96TJMU (-BS) Specifications
	Motor Output	kW	5.3	6.7		
	Crankcase Heater	W	45			
	Lubricant		MEL32			
Refrigerant	Type	R410A				
External Finish			Precoated Galvanized Sheets (plus powder-coating for -BS types) <Munsell No. 5Y 8/1 or Similar>			
Dimensions	Height	In.	65		Refer to PUHY-HP72TJMU (-BS) Specifications	Refer to PUHY-HP96TJMU (-BS) Specifications
	Width	In.	36-1/4	48-1/16		
	Depth	In.	29-15/16			
Net Weight		Lbs.	497	585		
Sound Pressure Level (As Measured in an Anechoic Room)		dB(A)	56 (61 in Heating at -5° F Outdoor Temperature)	57 (62 in Heating at -5° F Outdoor Temperature)	59 (64 in Heating at -5° F Outdoor Temperature)	60 (65 in Heating at -5° F Outdoor Temperature)
Protection Devices	High Pressure Protection		High-pressure Sensor, High-pressure Switch			
	Compressor/Fan		Overheat Protection/Thermal Switch			
	Inverter		Overheat and Overcurrent Protection			
Refrigerant Pipe Dimensions	Liquid (High Pressure) (Braze)	In.	1/2		5/8	
	Gas (Low Pressure) (Braze)	In.	3/4	7/8	1-1/8	
Indoor Unit	Total Capacity		50 to 130% of Outdoor Unit Capacity			
	Quantity		P06-P72/1-15	P06-P96/1-20	P06-P96/1-31	P06-P96/1-41
Operating Temperature Range	Cooling		**Outdoor: 23° F D.B. to 109° F D.B.			
	Heating		Outdoor: -13° F W.B. to +60° F W.B.			
Efficiency Ratings (Ducted/Non-Ducted) *4	EER		11.70/11.30	11.35/11.30	11.30/10.90	10.90/10.90
	IEER		16.80/16.20	16.00/15.40	14.40/13.85	13.60/13.10
	COP		3.66/3.35	3.39/3.35	3.56/3.25	3.29/3.25

Notes:

*1 Rating Conditions:

Cooling | Indoor: 80°F (26.7°C) DB/67°F (19°C) WB; Outdoor: 95°F (35°C) DB.
Heating | Indoor: 70°F (21.1°C) DB; Outdoor: 47°F (8.3°C) DB/43°F (6°C) WB.

*2 Twinning Kit CMY-Y100VBK2 is required for combining two individual outdoor units in the field for PUHY-HP-TSJMU combined systems.

*3 Each individual outdoor unit requires a separate electrical connection. Reference electrical data for each individual outdoor unit.

*4 Efficiency values based on AHRI 1230 test method.

** For details on extended ambient cooling operation range down to 0° FDB see Low Ambient Cooling section.

-BS indicates Seacoast Protection option.

Specifications are subject to change without notice.

LIMITED WARRANTY | Seven-year compressor and one year parts. Extended warranty of up to 10 years is available. See our website for details on specific additional application installation coverage.



SPECIFICATIONS: S-SERIES ▼

PUMY-P**NKMU1

Model Name			PUMY-P36NKMU1(-BS)	PUMY-P48NKMU1(-BS)	PUMY-P60NKMU1(-BS)
Power Source			208/230V, 1-Phase, 60Hz		
Capacity *1	Cooling	Btu/h	36,000	48,000	60,000
	Heating	Btu/h	42,000	54,000	66,000
Electrical Supply	MCA	A	31	31	36
	Maximum Fuse Size	A	44		42
Fan	Type x Quantity		Propeller Fan x 2		
	Airflow Rate	CFM	3,885		4,879
	Motor Output	kW	0.074		0.2
Compressor	Type		INVERTER-driven Scroll Hermetic		
	Operating Range	Cooling	29% to 100%	23% to 100%	36% to 100%
		Heating	24% to 100%	22% to 100%	22% to 100%
	Motor Output	kW	2.8	3.3	4.1
Lubricant		FV50S			
Refrigerant			R410A		
External Finish			Galvanized Sheets (plus Powder Coating for -BS Model) Munsell 3Y 7.8/1.1		
Dimensions	Height	In.	52-11/16		
	Width	In.	41-11/32		
	Depth	In.	13 (+1)		
Net Weight		Pounds	269		306
Sound Pressure Levels (As Measured in an Anechoic Room)		dB(A)	49/53	51/54	58/59
Protection Devices	High Pressure Protection		High Pressure Switch		
	Compressor/Fan		Discharge Thermo and Over-current Protection		Compressor Thermo/Over-current Protection
	Inverter		Over-current/Overheat Protection		Over-current/Voltage Protection
Refrigerant Pipe Dimensions	Liquid (High Pressure) (Flare)	In.	3/8		
	Gas (Low Pressure) (Flare)	In.	5/8	3/4	
Indoor Unit	Total Capacity		50 - 130% of Outdoor Unit Capacity		
	Quantity		P06-36/1-7	P06-P54/1-10	P06-P72/1-12
Operating Temperature Range	Cooling		Outdoor: 5° to 115° F D.B. *3 *4		
	Heating		Outdoor: -13° to +59° F W.B.		
Efficiency Ratings *2					
EER (Ducted/Non-Ducted) *2			12.6/14.2	11.3/12.6	11.1/12.5
SEER (Ducted/Non-Ducted) *2			15.6/21.0	16.5/20.2	17.0/18.6
COP (Ducted/Non-Ducted) *2			3.60/ 3.90	3.30/3.80	3.7/3.5
HSPF (Ducted/Non-Ducted) *2			10.5/11.5	11.0/11.7	10.7/11.4

Notes:

- *1 Rating Conditions:
Cooling | Indoor: 80° F (26.7° C) DB/67° F (19.4° C) WB; Outdoor: 95° F (35° C) DB.
Heating | Indoor: 70° F (21.1° C) DB; Outdoor: 47° F (8.3° C) DB/43° F (6.1° C) WB.
- *2 Efficiencies values based in AHRI 210/240 test method.
- *3 When using Wind Baffles [WB-PA3], the minimum operating range is 5° F.
Without Wind Baffles, the minimum operating range is 23° F.
- *4 When connecting PKFY-P06NBMU/P08NBMU, PFFY-P06/08/12NEMU or PFFY-P06/08/12NRMU indoor units, the minimum operating range is 50° F.

-BS indicates Seacoast Protection option.

LIMITED WARRANTY | Seven-year warranty on compressor. One-year warranty on parts. See our website for details on specific additional application installation coverage.

Specifications are subject to change.



SPECIFICATIONS: L-GENERATION W-SERIES ▼

PQRY-P**T(Y)LMU-A1

Model Name			208/230V	PQRY-P72TLMU-A1	PQRY-P96TLMU-A1	PQRY-P120TLMU-A1	PQRY-P144TLMU-A1
			460V	PQRY-P72YLMU-A1	PQRY-P96YLMU-A1	PQRY-P120YLMU-A1	PQRY-P144YLMU-A1
Power Source			208/230V, 3-Phase, 60Hz 460V, 3-Phase, 60Hz				
Capacity (Nominal) *1	Cooling	Btu/h	72,000	96,000	120,000	144,000	
	Heating	Btu/h	69,000	92,000	114,000	137,000	
Electrical Supply	MCA	A	13/12	19/17	29/26	35/32	
			6	9	13	16	
	MOP	A	20/20	30/25	50/45	60/50	
			15	15	20	25	
Compressor	Type x Quantity		INVERTER-driven Scroll Hermetic x 1				
	Operating Range		24% to 100%	18% to 100%	14% to 100%	19% to 100%	
	Lubricant		MEL32				
Circulating Water	Water Flow Rate	GPM	25.4	25.4	25.4	31.7	
	Pressure Drop	Ft. (psi)	8 (3.48)	8 (3.48)	8 (3.48)	15 (6.38)	
	Max Water Pressure 290 PSI/2 MPA						
Refrigerant	Type	R410A					
External Finish			Galvanized steel sheets				
Dimensions	Height	In.	43-5/16			57-1/8	
	Width	In.	34-11/16				
	Depth	In.	21-11/16				
Net Weight	Pounds	382				481	
		406				508	
Sound Pressure Level (As Measured in an Anechoic Room)		dB(A)	46	48	54		
Protection Devices	High Pressure Protection		High pressure sensor, High pressure switch				
	Compressor		Over-heat protection, Over-current protection				
	Inverter		Over-heat protection				
Refrigerant Pipe Dimensions	Liquid (High Pressure) (Brazed)	In.	5/8	3/4		7/8	
	Gas (Low Pressure) (Brazed)	In.	3/4	7/8		1-1/8	
Indoor Unit Connectable	Total Capacity		50 to 150% of water-source unit capacity				
	Model/Quantity		P06~P96/1~18	P06~P96/1~24	P06~P96/1~30	P06~P96/1~36	
Operating Temperature Range	Cooling	W.B.	Indoor: 59 to 75° F				
	Heating	D.B.	Indoor: 50 to 113° F				
Inlet Water Temperature Range	Cooling		50 to 113° F				
	Heating		50 to 113° F				
Efficiency Ratings (Ducted/ Non-Ducted) *2	EER		16.7/20.1	15.2/18.7	13.4/15.6	12.1/15.4	
	IEER		24.2/28.1	25.0/30.4	23.2/29.0	19.5/23.1	
	COP		5.51/6.05	5.77/5.93	5.51/5.60	4.90/5.50	

Notes:

*1 Rating Conditions:
Cooling | Indoor: 81° F (27° C) D.B./66° F (19° C) W.B.; Water Temperature: 86° F (30° C)
Heating | Indoor: 68° F (20° C) D.B.; Water Temperature: 68° F (20° C).

*2 Efficiency values based on AHRI 1230 test method.

Specifications are subject to change without notice.

LIMITED WARRANTY | Seven-year compressor and one year parts.
See our website for details on specific additional application installation coverage.



SPECIFICATIONS: L-GENERATION W-SERIES ▼

PQR-Y-P**T(Y)LMU-A1

Model Name			208/230V	PQR-Y-P168TLMU-A1	PQR-Y-P192TLMU-A1	PQR-Y-P216TLMU-A1	PQR-Y-P240TLMU-A1
			460V	PQR-Y-P168YLMU-A1	PQR-Y-P192YLMU-A1	PQR-Y-P216YLMU-A1	PQR-Y-P240YLMU-A1
Power Source							
Capacity (Nominal) *1	Cooling	Btu/h	168,000	192,000	216,000	240,000	
	Heating	Btu/h	161,000	183,000	206,000	228,000	
Electrical Supply	MCA	A	44/39	54/49	69/63	79/71	
			20	25	31	36	
	MOP	A	70/70	90/80	110/110	125/125	
			35	40	50	60	
Compressor	Type x Quantity		INVERTER-driven Scroll Hermetic x 1				
	Operating Range		16% to 100%	14% to 100%	13% to 100%	12% to 100%	
	Lubricant		MEL32				
Circulating Water	Water Flow Rate	GPM	31.7	31.7	50.7	50.7	
	Pressure Drop	Ft. (psi)	15 (6.38)	15 (6.38)	15 (6.53)	15 (6.53)	
	Max Water Pressure 290 PSI/2 MPA						
Refrigerant	Type		R410A				
External Finish			Galvanized steel sheets				
Dimensions	Height	In.	57-1/8				
	Width	In.	34-11/16				
	Depth	In.	21-11/16				
Net Weight	Pounds		481		558		
			508		574		
Sound Pressure Level (As Measured in an Anechoic Room)			56	58			
Protection Devices	High Pressure Protection		High pressure sensor, High pressure switch				
	Compressor		Over-heat protection, Over-current protection				
	Inverter		Over-heat protection				
Refrigerant Pipe Dimensions	Liquid (High Pressure) (Brazed)	In.	7/8		7/8 (1-1/8 for the part that exceeds 65 m)		
	Gas (Low Pressure) (Brazed)	In.	1-1/8			1-3/8	
Indoor Unit Connectable	Total Capacity		50 to 150% of water-source unit capacity				
	Model/Quantity		P06-P96/1-42	P06-P96/1-48	P06-P96/2-50 (Connectable branch pipe number is max. 48.)	P06-P96/2-50 (Connectable branch pipe number is max. 48.)	
Operating Temperature Range	Cooling	W.B.	Indoor: 59 to 75° F				
	Heating	D.B.	Indoor: 50 to 113° F				
Inlet Water Temperature Range	Cooling		50 to 113° F				
	Heating		50 to 113° F				
Efficiency Ratings (Ducted/ Non-Ducted) *2	EER		15.1/18.6	11.9/13.5	14.8/17.1	11.5/12.4	
	IEER		22.5/26.1	18.0/21.8	23.6/25.8	18.4/21.7	
	COP		5.29/5.94	4.73/5.39	5.57/5.67	4.60/5.15	

Notes:

*1 Rating Conditions:
Cooling | Indoor: 81° F (27° C) D.B./66° F (19° C) W.B.; Water Temperature: 86° F (30° C)
Heating | Indoor: 68° F (20° C) D.B.; Water Temperature: 68° F (20° C).

*2 Efficiency values based on AHRI 1230 test method.

Specifications are subject to change without notice.

LIMITED WARRANTY | Seven-year compressor and one year parts.
See our website for details on specific additional application installation coverage.



SPECIFICATIONS: L-GENERATION W-SERIES ▼

PQRY-P**T(Y)SLMU-A1

Model Name		208/230V	PQRY-P144TSLMU-A1 *2	PQRY-P168TSLMU-A1 *2	PQRY-P192TSLMU-A1 *2	PQRY-P216TSLMU-A1 *2	PQRY-P240TSLMU-A1 *2
			With 2 PQRY-P72TLMU-A1 *3	With 1 PQRY-P72TLMU-A1 and 1 PQRY-P96TLMU-A1 *3	With 2 PQRY-P96TLMU-A1 *3	With 1 PQRY-P96TLMU-A1 and 1 PQRY-P120TLMU-A1 *3	With 2 PQRY-P120TLMU-A1 *3
		460V	PQRY-P144YSLMU-A1 *2	PQRY-P168YSLMU-A1 *2	PQRY-P192YSLMU-A1 *2	PQRY-P216YSLMU-A1 *2	PQRY-P240YSLMU-A1 *2
			With 2 PQRY-P72YLMU-A1 *3	With 1 PQRY-P72YLMU-A1 and 1 PQRY-P96YLMU-A1 *3	With 2 PQRY-P96YLMU-A1 *3	With 1 PQRY-P96YLMU-A1 and 1 PQRY-P120YLMU-A1 *3	With 2 PQRY-P120YLMU-A1 *3
Power Source		208/230V, 3-Phase, 60Hz 460V, 3-Phase, 60Hz					
Capacity (Nominal) *1	Cooling	Btu/h	144,000	168,000	192,000	216,000	240,000
	Heating	Btu/h	160,000	188,000	215,000	243,000	270,000
Compressor		Operating Range	12% to 100%	10% to 100%	9% to 100%	8% to 100%	7% to 100%
		Type x Quantity	Refer to:	Refer to:	Refer to:	Refer to:	Refer to:
		Lubricant					
Circulating Water	Water Flow Rate	GPM (L/s)	PQRY-P72TLMU-A1	PQRY-P72TLMU-A1	PQRY-P96TLMU-A1	PQRY-P96TLMU-A1	PQRY-P120TLMU-A1
	Pressure Drop	Ft. (psi)		PQRY-P96TLMU-A1		PQRY-P120TLMU-A1	
	Operation Volume Range	GPM (L/m)		PQRY-P72YLMU-A1	PQRY-P96YLMU-A1	PQRY-P96YLMU-A1	PQRY-P120YLMU-A1
Refrigerant	Type		PQRY-P72YLMU-A1	PQRY-P72YLMU-A1	PQRY-P96YLMU-A1	PQRY-P96YLMU-A1	PQRY-P120YLMU-A1
External Finish							
Dimensions	Height	In.					
	Width	In.		PQRY-P96YLMU-A1		PQRY-P120YLMU-A1	
	Depth	In.					
Net Weight		Pounds					
Sound Pressure Level (As Measured in an Anechoic Room)		dB(A)	49	50	51	55	57
Protection Devices	High Pressure Protection		High pressure sensor, High pressure switch				
	Compressor/Fan		Overheat protection/Thermal switch				
	Inverter		Overheat and Overcurrent Protection				
Refrigerant Pipe Dimensions	Liquid (High Pressure) (Brazed)	In.	7/8			7/8 (1-1/8 for the part that exceeds 65 m)	
	Gas (Low Pressure) (Brazed)	In.	1-1/8				1-3/8
Indoor Unit Connectable	Total Capacity		50 to 150% of outdoor unit capacity				
	Model/Quantity		P06-P96/1-36	P06-P96/1-42	P06-P96/1-48	P06-P96/2-50 (Connectable branch pipe number is max. 48.)	P06-P96/2-50 (Connectable branch pipe number is max. 48.)
Inlet Water Temperature Range	Cooling		50 to 113° F				
	Heating		50 to 113° F				
Efficiency Ratings (Ducted/ Non-Ducted) *4	EER		14.4/16.2	11.2/10.9	13.5/14.9	10.8/11.0	12.5/13.8
	IEER		24.4/26.4	19.0/21.2	23.5/25.9	18.8/21.2	22.4/25.7
	COP		5.77/5.53	4.75/5.23	5.64/5.40	4.52/5.05	5.46/5.32

Notes:

- *1 Rating Conditions:
Cooling | Indoor: 81° F (27° C) D.B./66° F (19° C) W.B.; Water Temperature: 86° F (30° C)
Heating | Indoor: 68° F (20° C) D.B.; Water Temperature: 68° F (20° C).
- *2 Twinning kit is required for combining two individual outdoor units in the field for PQRY-P-T(Y)SLMU-A1.
- *3 Each individual outdoor unit requires a separate electrical connection. Reference electrical data for each individual outdoor unit.
- *4 Efficiency values based on AHRI 1230 test method.

Specifications are subject to change without notice.

LIMITED WARRANTY | Seven-year compressor and one year parts. See our website for details on specific additional application installation coverage.



SPECIFICATIONS: L-GENERATION W-SERIES ▼

PQRYSLMU-A1

Model Name		208/230V	PQRY-P288TSLMU-A1 *2 With 2 PQRY-P144TLMU-A1 *3	PQRY-P312TSLMU-A1 *2 With 1 PQRY-P72TLMU-A1 and 1 PQRY-P96TLMU-A1 *3	PQRY-P336TSLMU-A1 *2 With 2 PQRY-P168TLMU-A1 *3
		460V	PQRY-P288YSLMU-A1 *2 With 2 PQRY-P144YLMU-A1 *3	PQRY-P312YSLMU-A1 *2 With 1 PQRY-P72YLMU-A1 and 1 PQRY-P96YLMU-A1 *3	PQRY-P336YSLMU-A1 *2 With 2 PQRY-P168YLMU-A1 *3
Power Source		208/230V, 3-Phase, 60Hz 460V, 3-Phase, 60Hz			
Capacity (Nominal) *1	Cooling	Btu/h	288,000	312,000	336,000
	Heating	Btu/h	275,000	297,000	320,000
Compressor		Operating Range	9% to 100%	9% to 100%	8% to 100%
		Type x Quantity	Refer to: PQRY-P144TLMU-A1	Refer to: PQRY-P168TLMU-A1 PQRY-P144TLMU-A1	Refer to: PQRY-P168TLMU-A1
		Lubricant			
Circulating Water	Water Flow Rate	GPM (L/s)	PQRY-P144YLMU-A1	PQRY-P168YLMU-A1 PQRY-P144YLMU-A1	PQRY-P168YLMU-A1
	Pressure Drop	Ft. (psi)			
	Operation Volume Range	GPM (L/m)			
Refrigerant	Type		PQRY-P144YLMU-A1	PQRY-P168YLMU-A1 PQRY-P144YLMU-A1	PQRY-P168YLMU-A1
External Finish					
Dimensions	Height	In.			
	Width	In.			
	Depth	In.			
Net Weight		Pounds	57	58	59
Sound Pressure Level (As Measured in an Anechoic Room)		dB(A)	57	58	59
Protection Devices	High Pressure Protection		High pressure sensor, High pressure switch		
	Compressor/Fan		Overheat protection/Thermal switch		
	Inverter		Overheat and Overcurrent Protection		
Refrigerant Pipe Dimensions	Liquid (High Pressure) (Brazed)	In.	1-1/8		
	Gas (Low Pressure) (Brazed)	In.	1-3/8		
Indoor Unit Connectable	Total Capacity		50 to 150% of outdoor unit capacity		
	Model/Quantity		P06-P96/2-50 (Connectable branch pipe number is max. 48.)	P06-P96/2-50 (Connectable branch pipe number is max. 48.)	P06-P96/2-50 (Connectable branch pipe number is max. 48.)
Inlet Water Temperature Range	Cooling		50 to 113° F		
	Heating		50 to 113° F		
Efficiency Ratings (Ducted/ Non-Ducted) *4	EER		11.4/13.7	11.2/13.0	11.1/12.3
	IEER		18.5/20.6	17.6/20.4	16.8/20.1
	COP		4.90/5.25	4.78/5.24	4.66/5.23

Notes:

*1 Rating Conditions:

Cooling | Indoor: 81° F (27° C) D.B./66° F (19° C) W.B.;
Water Temperature: 86° F (30° C)

Heating | Indoor: 68° F (20° C) D.B.; Water Temperature: 68° F (20° C).

*2 Twinning kit is required for combining two individual outdoor units in the field for PQRYSLMU-A1.

*3 Each individual outdoor unit requires a separate electrical connection. Reference electrical data for each individual outdoor unit.

*4 Efficiency values based on AHRI 1230 test method.

Specifications are subject to change without notice.

LIMITED WARRANTY | Seven-year compressor and one year parts. See our website for details on specific additional application installation coverage.



SPECIFICATIONS: L-GENERATION W-SERIES ▼

PQHY-P**T(Y)LMU-A1

Model Name			208/230V	PQHY-P72TLMU-A1	PQHY-P96TLMU-A1	PQHY-P120TLMU-A1	PQHY-P144TLMU-A1
			460V	PQHY-P72YLMU-A1	PQHY-P96YLMU-A1	PQHY-P120YLMU-A1	PQHY-P144YLMU-A1
Power Source			208/230V, 3-Phase, 60Hz 460V, 3-Phase, 60Hz				
Capacity (Nominal) *1	Cooling	Btu/h	72,000	96,000	120,000	144,000	
	Heating	Btu/h	69,000	92,000	114,000	137,000	
Electrical Supply	MCA	A	13/12	19/17	29/26	35/32	
			6	9	13	16	
	MOP	A	20/20	30/25	50/45	60/50	
			15	15	20	25	
Compressor	Type x Quantity		INVERTER-driven Scroll Hermetic x 1				
	Operating Range		24% to 100%	18% to 100%	14% to 100%	19% to 100%	
	Lubricant		MEL32				
Circulating Water	Water Flow Rate	GPM	25.4	25.4	25.4	31.7	
	Pressure Drop	Ft. (psi)	8 (3.48)	8 (3.48)	8 (3.48)	15 (6.38)	
	Max Water Pressure 290 PSI/2 MPA						
Refrigerant	Type		R410A				
External Finish			Galvanized steel sheets				
Dimensions	Height	In.	43-5/16			57-1/8	
	Width	In.	34-11/16				
	Depth	In.	21-11/16				
Net Weight	Pounds		375			474	
			400			501	
Sound Pressure Level (As Measured in an Anechoic Room)		dB(A)	46	48	54		
Protection Devices	High Pressure Protection		High pressure sensor, High pressure switch				
	Compressor		Over-heat protection, Over-current protection				
	Inverter		Over-heat protection				
Refrigerant Pipe Dimensions	Liquid (High Pressure) (Brazed)	In.	3/8	3/8 (1/2, total length >= 90 m)		1/2	
	Gas (Low Pressure) (Brazed)	In.	3/4	7/8		1-1/8	
Indoor Unit Connectable	Total Capacity		50 to 150% of water-source unit capacity				
	Model/Quantity		P06~P96/1~15	P06~P96/1~20	P06~P96/1~26	P06~P96/1~31	
Operating Temperature Range	Cooling	W.B.	Indoor: 59 to 75° F				
	Heating	D.B.	Indoor: 50 to 113° F				
Inlet Water Temperature Range	Cooling		50 to 113° F				
	Heating		50 to 113° F				
Efficiency Ratings (Ducted/ Non-Ducted) *2	EER		17.4/20.7	15.3/19.4	13.5/15.9	12.1/15.6	
	IEER		24.2/28.1	25.0/30.4	23.2/29.0	19.5/23.1	
	COP		5.62/6.15	5.80/6.02	5.55/5.66	4.92/5.56	

Notes:

*1 Rating Conditions:
Cooling | Indoor: 81° F (27° C) D.B./66° F (19° C) W.B.; Water Temperature: 86° F (30° C)

Heating | Indoor: 68° F (20° C) D.B.; Water Temperature: 68° F (20° C).

*2 Efficiency values based on AHRI 1230 test method.

Specifications are subject to change without notice.

**LIMITED WARRANTY | Seven-year compressor and one year parts.
See our website for details on specific additional application installation coverage.**



SPECIFICATIONS: L-GENERATION W-SERIES ▼

PQHY-P**T(Y)LMU-A1

Model Name			208/230V	PQHY-P168TLMU-A1	PQHY-P192TLMU-A1	PQHY-P216TLMU-A1	PQHY-P240TLMU-A1
			460V	PQHY-P168YLMU-A1	PQHY-P192YLMU-A1	PQHY-P216YLMU-A1	PQHY-P240YLMU-A1
Power Source							
Capacity (Nominal) *1	Cooling	Btu/h	168,000	192,000	216,000	240,000	
	Heating	Btu/h	161,000	183,000	206,000	228,000	
Electrical Supply	MCA	A	44/39	54/49	69/63	79/71	
			20	25	31	36	
	MOP	A	70/70	90/80	110/110	125/125	
			35	40	50	60	
Compressor	Type x Quantity		INVERTER-driven Scroll Hermetic x 1				
	Operating Range		16% to 100%	14% to 100%	13% to 100%	12% to 100%	
	Lubricant		MEL32				
Circulating Water	Water Flow Rate	GPM	31.7	31.7	50.7	50.7	
	Pressure Drop	Ft. (psi)	15 (6.38)	15 (6.38)	15 (6.53)	15 (6.53)	
	Max Water Pressure 290 PSI/2 MPA						
Refrigerant	Type		R410A				
External Finish			Galvanized steel sheets				
Dimensions	Height	In.	57-1/8				
	Width	In.	34-11/16				
	Depth	In.	21-11/16				
Net Weight	Pounds	474			552		
		501			567		
Sound Pressure Level (As Measured in an Anechoic Room)		dB(A)	56	58			
Protection Devices	High Pressure Protection		High pressure sensor, High pressure switch				
	Compressor		Over-heat protection, Over-current protection				
	Inverter		Over-heat protection				
Refrigerant Pipe Dimensions	Liquid (High Pressure) (Brazed)	In.	5/8				
	Gas (Low Pressure) (Brazed)	In.	1-1/8				
Indoor Unit Connectable	Total Capacity		50 to 150% of water-source unit capacity				
	Model/Quantity		P06-P96/1-36	P06-P96/1-41	P06-P96/2-46	P06-P96/2-50	
Operating Temperature Range	Cooling	W.B.	Indoor: 59 to 75° F				
	Heating	D.B.	Indoor: 50 to 113° F				
Inlet Water Temperature Range	Cooling		50 to 113° F				
	Heating		50 to 113° F				
Efficiency Ratings (Ducted/ Non-Ducted) *2	EER		15.2/19.0	12.0/13.6	15.0/17.3	11.5/12.5	
	IEER		22.5/26.1	18.0/21.8	23.6/25.8	18.4/21.7	
	COP		5.32/6.01	4.76/5.43	5.61/5.72	4.62/5.19	

Notes:

*1 Rating Conditions:
 Cooling | Indoor: 81° F (27° C) D.B./66° F (19° C) W.B.; Water Temperature: 86° F (30° C)
 Heating | Indoor: 68° F (20° C) D.B.; Water Temperature: 68° F (20° C).

*2 Efficiency values based on AHRI 1230 test method.

Specifications are subject to change without notice.

LIMITED WARRANTY | Seven-year compressor and one year parts.
 See our website for details on specific additional application installation coverage.



SPECIFICATIONS: L-GENERATION W-SERIES ▼

PQHY-P**T(Y)SLMU-A1

Model Name	208/230V	PQHY-P144TSLMU-A1 *2		PQHY-P168TSLMU-A1 *2		PQHY-P192TSLMU-A1 *2		PQHY-P216TSLMU-A1 *2		PQRY-P240TSLMU-A1 *2	
		With 2 PQHY-P72TLMU-A1 *3		With 1 PQHY-P72TLMU-A1 and 1 PQHY-P96TLMU-A1 *3		With 2 PQHY-P96TLMU-A1 *3		With 1 PQHY-P96TLMU-A1 and 1 PQHY-P120TLMU-A1 *3		With 2 PQHY-P120TLMU-A1 *3	
		PQHY-P144YSLMU-A1 *2		PQHY-P168YSLMU-A1 *2		PQHY-P192YSLMU-A1 *2		PQHY-P216YSLMU-A1 *2		PQHY-P240YSLMU-A1 *2	
	460V	With 2 PQHY-P72YLMU-A1 *3		With 1 PQHY-P72YLMU-A1 and 1 PQHY-P96YLMU-A1 *3		With 2 PQHY-P96YLMU-A1 *3		With 1 PQHY-P96YLMU-A1 and 1 PQHY-P120YLMU-A1 *3		With 2 PQHY-P120YLMU-A1 *3	
Power Source		208/230V, 3-Phase, 60Hz 460V, 3-Phase, 60Hz									
Capacity (Nominal) *1	Cooling	Btu/h	144,000	168,000	192,000	216,000	240,000				
	Heating	Btu/h	160,000	188,000	215,000	243,000	270,000				
Compressor	Operating Range		12% to 100%	10% to 100%	9% to 100%	8% to 100%	7% to 100%				
	Type x Quantity										
Circulating Water	Lubricant		Refer to: PQHY-P72TLMU-A1								
	Water Flow Rate	GPM (L/s)	Refer to: PQHY-P72TLMU-A1 PQHY-P96TLMU-A1								
	Pressure Drop	Ft. (psi)	Refer to: PQHY-P96TLMU-A1 PQHY-P120TLMU-A1								
Operation Volume Range	GPM (L/m)										
	Type		PQHY-P72YLMU-A1	PQHY-P72YLMU-A1 PQHY-P96YLMU-A1	PQHY-P96YLMU-A1	PQRY-P96YLMU-A1 PQRY-P120YLMU-A1	PQHY-P120YLMU-A1				
Refrigerant											
External Finish											
Dimensions	Height	In.									
	Width	In.									
	Depth	In.									
Net Weight	Pounds		49	50	51	55	57				
Protection Devices	High Pressure Protection		High pressure sensor, High pressure switch								
	Compressor/Fan		Overheat protection/Thermal switch								
	Inverter		Overheat and Overcurrent Protection								
Refrigerant Pipe Dimensions	Liquid (High Pressure) (Braze)	In.	1/2	5/8							
	Gas (Low Pressure) (Braze)	In.	1-1/8								
Indoor Unit Connectable	Total Capacity		50 to 150% of outdoor unit capacity								
	Model/Quantity		P06~P96/1~31	P06~P96/1~36	P06~P96/1~41	P06~P96/2~46	P06~P96/2~50				
Inlet Water Temperature Range	Cooling		50 to 113° F								
	Heating		50 to 113° F								
Efficiency Ratings (Ducted/Non-Ducted) *4	EER		14.5/16.4	11.3/10.9	13.6/15.0	10.8/11.0	12.5/13.9				
	IEER		24.4/26.4	19.0/21.2	23.5/25.9	18.8/21.2	22.4/25.7				
	COP		5.80/5.57	4.77/5.26	5.68/5.43	4.54/5.08	5.49/5.35				

Notes:

- *1 Rating Conditions:
Cooling | Indoor: 81° F (27° C) D.B./66° F (19° C) W.B.; Water Temperature: 86° F (30° C)
Heating | Indoor: 68° F (20° C) D.B.; Water Temperature: 68° F (20° C).
- *2 Twinning kit is required for combining two individual outdoor units in the field for PQRY-P-T(Y)SLMU-A1.
- *3 Each individual outdoor unit requires a separate electrical connection. Reference electrical data for each individual outdoor unit.
- *4 Efficiency values based on AHRI 1230 test method.

Specifications are subject to change without notice.

LIMITED WARRANTY | Seven-year compressor and one year parts. See our website for details on specific additional application installation coverage.

SPECIFICATIONS: L-GENERATION W-SERIES ▼



PQHY-P**T(Y)SLMU-A1

Model Name		208/230V		PQHY-P288TSLMU-A1 *2	PQHY-P312TSLMU-A1 *2	PQHY-P336TSLMU-A1 *2	PQHY-P360TSLMU-A1 *2	
		With 2 PQHY-P144TLMU-A1 *3		With 1 PQHY-P144TLMU-A1 and 1 PQHY-P168TLMU-A1 *3	With 2 PQHY-P168TLMU-A1 *3	With 1 PQHY-P168TLMU-A1 and 1 PQHY-P192TLMU-A1 *3		
		460V	PQHY-P288YSLMU-A1 *2	PQHY-P312YSLMU-A1 *2	PQHY-P336YSLMU-A1 *2	PQHY-P360YSLMU-A1 *2		
			With 2 PQHY-P144YLMU-A1 *3	With 1 PQHY-P144YLMU-A1 and 1 PQHY-P168YLMU-A1 *3	With 2 PQHY-P168YLMU-A1 *3	With 1 PQHY-P168YLMU-A1 and 1 PQHY-P192YLMU-A1 *3		
Power Source		208/230V, 3-Phase, 60Hz 460V, 3-Phase, 60Hz						
Capacity (Nominal) *1	Cooling	Btu/h	288,000	312,000	336,000	360,000		
	Heating	Btu/h	323,000	350,000	378,000	405,000		
Compressor	Operating Range		9% to 100%		9% to 100%		8% to 100%	
	Type x Quantity		Refer to:		Refer to:		Refer to:	
	Lubricant		PQHY-P144TLMU-A1		PQHY-P72TLMU-A1 PQHY-P96TLMU-A1		PQHY-P168TLMU-A1	
Circulating Water	Water Flow Rate	GPM (L/s)	PQHY-P144TLMU-A1		PQHY-P72TLMU-A1 PQHY-P96TLMU-A1		PQHY-P168TLMU-A1 PQHY-P192TLMU-A1	
	Pressure Drop	Ft. (psi)	PQHY-P144TLMU-A1		PQHY-P72TLMU-A1 PQHY-P96TLMU-A1		PQHY-P168TLMU-A1 PQHY-P192TLMU-A1	
	Operation Volume Range	GPM (L/m)	PQHY-P144TLMU-A1		PQHY-P72TLMU-A1 PQHY-P96TLMU-A1		PQHY-P168TLMU-A1 PQHY-P192TLMU-A1	
Refrigerant	Type		PQHY-P144YLMU-A1		PQHY-P72YLMU-A1 PQHY-P96YLMU-A1		PQHY-P168YLMU-A1 PQHY-P192YLMU-A1	
External Finish		PQHY-P144YLMU-A1						
Dimensions	Height	In.	PQHY-P144YLMU-A1		PQHY-P72YLMU-A1 PQHY-P96YLMU-A1		PQHY-P168YLMU-A1 PQHY-P192YLMU-A1	
	Width	In.	PQHY-P144YLMU-A1		PQHY-P72YLMU-A1 PQHY-P96YLMU-A1		PQHY-P168YLMU-A1 PQHY-P192YLMU-A1	
	Depth	In.	PQHY-P144YLMU-A1		PQHY-P72YLMU-A1 PQHY-P96YLMU-A1		PQHY-P168YLMU-A1 PQHY-P192YLMU-A1	
Net Weight	Pounds		PQHY-P144YLMU-A1		PQHY-P72YLMU-A1 PQHY-P96YLMU-A1		PQHY-P168YLMU-A1 PQHY-P192YLMU-A1	
Sound Pressure Level (As Measured in an Anechoic Room)	dB(A)		57	58	59	60		
Protection Devices	High Pressure Protection		High pressure sensor, High pressure switch					
	Compressor/Fan		Overheat protection/Thermal switch					
	Inverter		Overheat and Overcurrent Protection					
Refrigerant Pipe Dimensions	Liquid (High Pressure) (Brazed)	In.	3/4					
	Gas (Low Pressure) (Brazed)	In.	1-3/8			1-5/8		
Indoor Unit Connectable	Total Capacity		50 to 150% of outdoor unit capacity					
	Model/Quantity		P06~P96/2~50	P06~P96/2~50	P06~P96/2~50	P06~P96/2~50		
Inlet Water Temperature Range	Cooling		50 to 113° F					
	Heating		50 to 113° F					
Efficiency Ratings (Ducted/ Non-Ducted) *4	EER		11.4/13.8	11.2/13.0	11.1/12.3	11.2/12.1		
	IEER		18.5/20.6	17.6/20.4	16.8/20.1	17.5/20.3		
	COP		4.92/5.27	4.80/5.26	4.67/5.25	4.64/5.14		

Notes:

- *1 Rating Conditions:
Cooling | Indoor: 81° F (27° C) D.B./66° F (19° C) W.B.; Water Temperature: 86° F (30° C)
Heating | Indoor: 68° F (20° C) D.B.; Water Temperature: 68° F (20° C).
- *2 Twinning kit is required for combining two individual outdoor units in the field for PQRY-P-T(Y)SLMU-A1.
- *3 Each individual outdoor unit requires a separate electrical connection. Reference electrical data for each individual outdoor unit.
- *4 Efficiency values based on AHRI 1230 test method.

Specifications are subject to change without notice.

LIMITED WARRANTY | Seven-year compressor and one year parts. See our website for details on specific additional application installation coverage.



PWFY-PNMU-E(E2)-AU/BU**

Model Name			PWFY-P36NMU-E2-AU	PWFY-P72NMU-E2-AU	PWFY-P36NMU-E-BU
Power Source			208/230V, 1-phase, 60Hz		
Cooling Capacity *1	Btu/h		36,200	72,000	-
Heating Capacity *1	Btu/h		39,900	79,800	39,900
Power Consumption	Cooling	kW	0.025 – 0.028		N/A
	Heating	kW	0.025 – 0.028		2.48
Current	Cooling	A	0.145 – 0.150		N/A
	Heating	A	0.145 – 0.150		12.30 /11.12
External Finish			Galvanized-steel Sheet		
Dimensions	Height	In.	31-1/2		
	Width	In.	17-3/4		
	Depth	In.	11-13/16		
Net Weight	Unit	Pounds	73	80	133
Operating Outdoor Temperature Range	Cooling		23° F to 115° F D.B. (PURY/PUHY/PURY-HP) 23° F to 109° F D.B. (PUHY-HP)		-
	Heating		-4 F to 90 F W.B. (PURY/PUHY) -13 F to 60 F W.B. (PURY-HP/PUHY-HP)		-4 ° F to 90° F W.B.
Circulating Water Operation Volume Range	GPM (L/m)		4.8 – 9.4 (18-36)	7.9 – 18.9 (30-72)	2.6 – 9.6 (10-36)
Circulating Water Design Pressure		MPa (psi)	1 (145)		
Water Piping Dimensions	Inlet	In.	3/4 FPT	1 FPT	3/4 FPT
	Outlet	In.	3/4 FPT	1 FPT	3/4 FPT
Refrigerant Pipe Dimensions	Liquid (High Pressure) (Braze)	In.	3/8	3/8	3/8
	Gas (Low Pressure) (Braze)	In.	5/8	3/4	5/8
Drainpipe Dimensions (O.D.)		In.	1-1/4		
Sound Pressure Levels		dB(A)	29		44
Connectable Outdoor Units			PURY-P72-288T/Y(S)KMU (-BS) PURY-HP72-192T/Y(S)KMU (-BS) PUHY-P72-360T/Y(S)KMU (-BS) PURY-P72-336T/Y(S)LMU-A (-BS) PQRV-P72-336T/Y(S)LMU-A1 (-BS) PUHY-P72-360T/Y(S)LMU-A (-BS) PQHY-P72-360T/Y(S)LMU-A1 (-BS)		PURY-P72-288T/Y(S)KMU (-BS) PURY-HP72-192T/Y(S)KMU (-BS) PURY-P72-336T/Y(S)LMU-A (-BS) PQRV-P72-336T/Y(S)LMU-A1 (-BS)

Notes:

*1 Nominal heating conditions (PWFY conditions are indicated in the parentheses).

(W-Series)

Outdoor Temp.: 47° F D.B./43° F W.B. (8.3° C D.B./6.1° C W.B.)
 Pipe length: 25 ft (7.6 m)
 Level difference: 0 ft (0 m)
 (Inlet water Temp.: 149° F (65°C) Water flow rate: 9.4 gpm (2.15 m³/h))

(WR2-Series)

Circulating water Temp.: 70° F (21.1° C)
 Pipe length: 25 ft (7.6 m)
 Level difference: 0 ft (0 m)
 (Inlet water Temp.: 149° F (65° C) Water flow rate 9.2 gpm (2.15 m³/h))

Note: Consult Application Note 2014 — Designing with PWFY for additional design assistance.

Note: The design water pressure drop and flow. Note that the pressure drop doesn't include strainers.

Specifications are subject to change without notice.

LIMITED WARRANTY | Seven-year compressor and one year parts. Extended warranty of up to 10 years is available. See our website for details on specific additional application installation coverage.

SPECIFICATIONS: PKFY ▼

WALL-MOUNTED INDOOR UNIT



PKFY-PN(H,K)MU-E2**

Model Name			PKFY-P06NBMU-E2R1	PKFY-P08NHMU-E2	PKFY-P12NHMU-E2	PKFY-P15NHMU-E2	PKFY-P18NHMU-E2	PKFY-P24NK-MU-E2.TH	PKFY-P30NK-MU-E2.TH
Power Source			208/230V, 1-Phase, 60Hz						
Cooling Capacity	Btu/h *1		6,000	8,000	12,000	15,000	18,000	24,000	30,000
Heating Capacity	Btu/h *1		6,700	9,000	13,500	17,000	20,000	27,000	34,000
Power Consumption	Cooling	W	8	30				70	
	Heating	W	30	30				70	
Current	Cooling	A	.15	.30				0.50	
	Heating	A	.15	.30				0.50	
External Finish	Munsell No.		1.0Y 9.2/0.2						
Dimensions	Height	In.	11-5/8					14-3/8	
	Width	In.	32-1/8	35-3/8				46-1/16	
	Depth	In.	8-7/8	9-13/16				11-5/8	
Net Weight	Unit	Pounds	22	29				46	
Heat Exchanger			Cross Fin (Aluminum Plate Fin and Copper Tube)						
Fan	Type x Quantity		Line Flow Fan x 1						
	Airflow Rate *2	CFM	170 – 180 – 200 – 210	320 – 370 – 413			320 – 370 – 425	570 – 920	710 – 920
	Motor Type		Single-phase Induction Motor	Direct-driven DC Motor					
Air Filter			Polypropylene Honeycomb						
Refrigerant Pipe Dimensions	Liquid (High Pressure) (Flare)	In.	1/4					3/8	
	Gas (Low Pressure) (Flare)	In.	1/2					5/8	
Drain Pipe Dimension (I.D.)		In.	5/8						
Sound Pressure Levels *2		dB(A)	32 – 33 – 35 – 36	34 – 39 – 43			36 – 41 – 45	39 – 49	43 – 49

Notes:

*1 Cooling/Heating Capacity indicates the maximum value at operation under the following conditions:

Cooling | Indoor: 80° F (27° C) D.B./67° F (19° C) W.B.; Outdoor: 95° F (35° C) D.B.

Heating | Indoor: 70° F (21° C) D.B.; Outdoor: 45° F (7° C) D.B./43° F (6° C) W.B.

*2 Airflow Rate/Sound Pressure Levels are at Lo-Mid1-Mid2-Hi, Lo-Mid-Hi, or Lo-Hi.

Specifications are subject to change without notice.

LIMITED WARRANTY | Seven-year compressor and one year parts. Extended warranty of up to 10 years is available. See our website for details on specific additional application installation coverage.



SPECIFICATIONS: PLFY

CEILING CASSETTE INDOOR UNIT

PLFY-P**NEMU-E

Model Name			PLFY-P08NEMU-E	PLFY-P12NEMU-E	PLFY-P15NEMU-E	PLFY-P18NEMU-E
Power Source			208/230V, 1-Phase, 60Hz			
Cooling Capacity	Btu/h *1		8,000	12,000	15,000	18,000
Heating Capacity	Btu/h *1		9,000	13,500	17,000	20,000
Power Consumption	Cooling	W	20			
	Heating	W	20			
Current	Cooling	A	0.25	0.26	0.29	
	Heating	A	0.20	0.21	0.24	
External Finish Color (Munsell No.)			Grille 6.4Y 8.9/0.4			
Dimensions	Height	In.	10-3/16			
	Width	In.	33-3/32			
	Depth	In.	33-3/32			
Net Weight *2	Unit/Panel	Pounds	42/11			
Heat Exchanger			Cross Fin (Aluminum Plate Fin and Copper Tube)			
Fan	Type x Quantity		Turbo Fan x 1			
	Airflow Rate *3	CFM	424 - 459 - 494 - 530	459 - 494 - 530 - 565	459 - 494 - 530 - 600	459 - 494 - 565 - 636
	Motor Type		DC Motor			
	Motor Output	W	50			
Air Filter			Polypropylene Honeycomb			
Refrigerant Pipe Dimensions	Liquid (High Pressure) (Flare)	In.	1/4			
	Gas (Low Pressure) (Flare)	In.	1/2			
Drain Pipe Dimension (O.D.)		In.	1-1/4			
Sound Pressure Levels (As Measured in an Anechoic Room)*3	(Low-Mid1-Mid2-High)	dB(A)	27 - 29 - 30 - 31	27 - 29 - 30 - 31	28 - 29 - 30 - 31	28 - 30 - 31 - 32
Model Name			PLFY-P24NEMU-E	PLFY-P30NEMU-E	PLFY-P36NEMU-E	PLFY-P48NEMU-E
Power Source			208/230, 1-phase, 60Hz			
Cooling Capacity	Btu/h *1		24,000	30,000	36,000	48,000
Heating Capacity	Btu/h *1		34,000	40,000	54,000	20,000
Power Consumption	Cooling	W	40	50	80	100
	Heating	W	40	50	80	100
Current	Cooling	A	0.41	0.56	0.90	0.99
	Heating	A	0.36	0.51	0.85	0.94
External Finish Color (Munsell No.)			Grille 6.4Y 8.9/0.4			
Dimensions	Height	In.	11-3/4			
	Width	In.	33-3/32			
	Depth	In.	33-3/32			
Net Weight *2	Unit/Panel	Pounds	46/11	46/11	51/11	55/11
Heat Exchanger			Cross Fin (Aluminum Plate Fin and Copper Tube)			
Fan	Type x Quantity		Turbo Fan x 1			
	Airflow Rate *3	CFM	494 - 565 - 671 - 777	494 - 600 - 742 - 883	706 - 883 - 1060 - 1201	742 - 918 - 1060 - 1236
	Motor Type		DC Motor			
	Motor Output	W	50			120
Air Filter			Polypropylene Honeycomb			
Refrigerant Pipe Dimensions	Liquid (High Pressure) (Flare)	In.	3/8			
	Gas (Low Pressure) (Flare)	In.	5/8			
Drain Pipe Dimension (O.D.)		In.	1-1/4			
Sound Pressure Levels (As Measured in an Anechoic Room)*3	(Low-Mid1-Mid2-High)	dB(A)	28 - 31 - 34 - 37	28 - 32 - 35 - 38	35 - 38 - 41 - 44	36 - 39 - 42 - 45

Notes:

- *1 Cooling/Heating capacity indicates the maximum value at operation under the following conditions:
Cooling | Indoor: 80° F (26.7° C) DB/67° F (19.4° C) WB; Outdoor: 95° F (35° C) DB.
Heating | Indoor: 70° F (21° C) DB; Outdoor: 47° F (8° C) DB/43° F (6° C) WB.
- *2 Net weight is shown for unit/grille.
- *3 Airflow rate/sound pressure levels are at (Low-Mid1-Mid2-High).

Ventilation Air: Providing sufficient ventilation air is an important part of every building design ASHRAE Standard 62 provides the minimum ventilation air requirements. Also check local codes.

LIMITED WARRANTY | Seven-year warranty on compressor. One-year warranty on parts. See our website for details on specific additional application installation coverage.

Specifications are subject to change.



SPECIFICATIONS: PLFY ▼

CEILING CASSETTE INDOOR UNIT

PLFY-P**NCMU-ER2

Model Name			PLFY-P08NCMU-ER2	PLFY-P12NCMU-ER2	PLFY-P15NCMU-ER2
Power Source			208/230V, 1-phase, 60Hz		
Cooling Capacity		Btu/h *1	8,000	12,000	15,000
Heating Capacity		Btu/h *1	9,000	13,500	17,000
Power Consumption	Cooling	W	50	60	
	Heating	W	50	60	
Current	Cooling	A	0.23	0.28	
	Heating	A	0.23	0.28	
External Finish (Munsell No.)			Grille: White (6.4Y 8.9/0.4)		
Dimensions	Height	In.	8-3/16		
	Width	In.	22-7/16		
	Depth	In.	22-7/16		
Net Weight *2	Unit/Panel	Pounds	34/7	37/7	
Heat Exchanger			Cross Fin (Aluminum Plate Fin and Copper Tube)		
Fan	Type x Quantity		Turbo Fan x 1		
	Airflow Rate *3	CFM	280-320-350	320-350-390	
	Motor Type		Single-phase Induction Motor		
Air Filter			Polypropylene Honeycomb		
Refrigerant Pipe Dimensions	Liquid (High Pressure) (Flare)	In.	1/4		
	Gas (Low Pressure) (Flare)	In.	1/2		
Condensate Lift Mechanism (Standard)		In.	19-11/16		
Drain Pipe Dimension (O.D.)		In.	1-1/4		
Sound Pressure Levels (As Measured in an Anechoic Room) *3	(Low-Mid-High)	dB(A)	29-32-38	30-34-39	31-35-40

Notes:

*1 Cooling/Heating capacity indicates the maximum value at operation under the following conditions:
 Cooling | Indoor: 80° F (27° C) D.B./67° F (19° C) W.B.; Outdoor: 95° F (35° C) D.B.
 Heating | Indoor: 70° F (21° C) D.B.; Outdoor: 47° F (8° C) D.B./43° F (6° C) W.B.

*2 Net weight is shown for unit/grille.

*3 Airflow rate/sound pressure levels are at (Low-Mid-High).

Ventilation Air: Providing sufficient ventilation air is an important part of every building design. ASHRAE Standard 62 provides the minimum ventilation air requirements. Also check local codes.

Specifications are subject to change without notice.

LIMITED WARRANTY | Seven-year compressor and one year parts. Extended warranty of up to 10 years is available. See our website for details on specific additional application installation coverage.



PMFY-P**NBMU-ER5

Model Name			PMFY-P06NBMU-ER5	PMFY-P08NBMU-ER5	PMFY-P12NBMU-ER5	PMFY-P15NBMU-ER5
Power Source			208/230V, 1-phase, 60Hz			
Cooling Capacity	Btu/h *1		6,000	8,000	12,000	15,000
Heating Capacity	Btu/h *1		6,700	9,000	13,500	17,000
Power Consumption	Cooling	W	40			50
	Heating	W	40			50
Current	Cooling	A	0.20		0.21	0.26
	Heating	A	0.20		0.21	0.26
External Finish Color (Munsell No.)			Grille: 6.4Y 8.9/0.4			
Dimensions	Height	In.	9-1/16			
	Width	In.	31-31/32			
	Depth	In.	15-9/16			
Net Weight	Unit	Pounds	31			
Heat Exchanger			Cross Fin			
Fan	Type x Quantity		Line flow fan x 1			
	Airflow Rate *2	CFM	230 - 254 - 283 - 307	258 - 283 - 304 - 328	258 - 283 - 304 - 328	272 - 307 - 343 - 378
	Motor Type		DC Brushless Motor			
Air Filter			Polypropylene Honeycomb			
Refrigerant Pipe Dimensions	Liquid (High Pressure) (Flare)	In.	1/4			
	Gas (Low Pressure) (Flare)	In.	1/2			
Condensate Lift Mechanism (Standard)		In.	23-5/8			
Drain Pipe Dimension (O.D.)		In.	1			
Sound Pressure Levels (As Measured in an Anechoic Room) *2	(Low-Mid1-Mid2-High)	dB(A)	27 - 30 - 33 - 35	32 - 34 - 36 - 37	32 - 34 - 36 - 37	33 - 35 - 37 - 39

Notes:

*1 Cooling/Heating capacity indicates the maximum value at operation under the following conditions:
 Cooling | Indoor: 80° F (27° C) D.B./67° F (19° C) W.B.; Outdoor: 95° F (35° C) D.B.
 Heating | Indoor: 70° F (21° C) D.B.; Outdoor: 47° F (8° C) DB/43° F (6° C) W.B.

*2 Airflow rate/sound levels are at (Low-Mid1-Mid2-High).

Ventilation Air: Providing sufficient ventilation air is an important part of every building design.

ASHRAE standard 62 provides the minimum ventilation air requirements. Also check local codes.

Specifications are subject to change without notice.

LIMITED WARRANTY | Seven-year compressor and one year parts. Extended warranty of up to 10 years is available. See our website for details on specific additional application installation coverage.



SPECIFICATIONS: PCFY ▼

CEILING-SUSPENDED INDOOR UNIT

PCFY-P**NKMU-ER1

Model Name			PCFY-P15NKMU-ER1	PCFY-P24NKMU-ER1	PCFY-P30NKMU-ER1	PCFY-P36NKMU-ER1
Power Source			208/230V, 1 Phase, 60Hz			
Cooling Capacity		Btu/h *1	15,000	24,000	30,000	36,000
Heating Capacity		Btu/h *1	17,000	27,000	34,000	40,000
Power Consumption	Cooling	W	30	40	90	110
	Heating	W	30	40	90	110
Current	Cooling	A	0.35	0.41	0.83	0.97
	Heating	A	0.35	0.41	0.83	0.97
External Finish		Munsell No.	6.4Y 8.9/0.4			
Dimensions	Height	In.	9-1/16			
	Width	In.	37-13/16	50-3/8	63	
	Depth	In.	26-3/4			
Net Weight	Unit	Pounds	53	71	79	84
Heat Exchanger			Cross Fin (Aluminum Plate Fin and Copper Tube)			
Fan	Type x quantity		Sirocco Fan x 2	Sirocco Fan x 3	Sirocco Fan x 4	
	Airflow Rate *2	CFM	353 - 388 - 424 - 459	494 - 530 - 565 - 636	703 - 777 - 883 - 989	742 - 847 - 953 - 1,095
	Motor Type		Direct - driven DC Motor			
Air Filter			Polypropylene Honeycomb			
Refrigerant Pipe Dimensions	Liquid (High Pressure) (Flare)	In.	1/4	3/8		
	Gas (Low Pressure) (Flare)	In.	1/2	5/8		
Drain Pipe Dimension (O.D.)		In.	1			
Sound Pressure Levels *2	Lo-Mid1-Mid2-Hi	dB(A)	29 - 32 - 34 - 36	31 - 33 - 35 - 37	34 - 37 - 40 - 43	36 - 39 - 42 - 44

Note:

*1 Cooling/Heating Capacity indicates the maximum value at operation under the following conditions:
 Cooling | Indoor: 80° F (27° C) D.B./67° F (19° C) W.B.; Outdoor 95° F (35° C) D.B.
 Heating | Indoor: 70° F (21° C) D.B.; Outdoor: 45° F (7° C) D.B./43° F (6° C) W.B.

*2 Airflow rate/sound pressure levels are at Low-Mid1-Mid2-Hi.

Ventilation Air: Providing sufficient ventilation air is an important part of every building design. ASHRAE Standard 62 provides the minimum air requirements. Also check local codes.

Specifications are subject to change without notice.

LIMITED WARRANTY | Seven-year compressor and one year parts. Extended warranty of up to 10 years is available. See our website for details on specific additional application installation coverage.

SPECIFICATIONS: PEFY ▼
CEILING-CONCEALED INDOOR UNIT



PEFY-P**NMSU-ER2

Model Name			PEFY-P06NM-SU-ER2* 1	PEFY-P08NM-SU-ER2	PEFY-P12NM-SU-ER2	PEFY-P15NMSU-ER2	PEFY-P18NMSU-ER2	PEFY-P24NMSU-ER2	
Power Source			208/230V, 1-phase, 60Hz						
Cooling Capacity *2		Btu/h	6,000	8,000	12,000	15,000	18,000	24,000	
Heating Capacity *2		Btu/h	6,700	9,000	13,500	17,000	20,000	27,000	
Power Consumption	Cooling	W	50/50	60/60	70/70		90/90	120/120	
	Heating	W	30/30	40/40	50/50		70/70	100/100	
Current	Cooling	A	0.42/0.41	0.51/0.49	0.56/0.53	0.57/0.55	0.74/0.70	0.98/0.93	
	Heating	A	0.32/0.31	0.41/0.39	0.46/0.43	0.47/0.45	0.64/0.60	0.88/0.83	
External Finish			Galvanized Steel Sheets						
Dimensions	Height	In.	7-7/8						
	Width	In.	31-1/8			39		46-7/8	
	Depth	In.	27-9/16						
Net Weight	Unit	Pounds	42	46	54	62			
Heat Exchanger			Cross Fin (Aluminum Plate Fin and Copper Tube)						
Fan	Type x Quantity		Sirocco Fan x 2			Sirocco Fan x 3		Sirocco Fan x 4	
	Airflow Rate *3	CFM	176 – 212 – 247	194 – 247 – 317	211 – 282 – 370	282 – 335 – 388	353 – 441 – 529	423 – 565 – 706	
	External Static Pressure *4	In. W.G.	0.02 – 0.06 – 0.14 – 0.20						
	Motor Type		DC Brushless Motor						
Air Filter			Polypropylene Honeycomb Fabric (washable)						
	Liquid (High Pressure) (Brazed)	In.	1/4					3/8	
Refrigerant Pipe Dimensions	Gas (Low Pressure) (Brazed)	In.	1/2					5/8	
Condensate Lift Mechanism (standard)		In.	21 – 4/16						
Drain Pipe Dimensions (O.D.)		In.	1 – 1/4						
Sound Pressure Levels *3	Low-Mid-High	dB(A)	22 – 24 – 28	23 – 26 – 30	23 – 28 – 35	28 – 30 – 33	30 – 34 – 37	30 – 35 – 40	

Notes:

*1 Not compatible with PUHY/PURY-P-TGMU or PQHY/PQRY-P-TGMU units.

*2 Cooling/Heating capacity indicates the maximum value at operation under the following conditions:
Cooling | Indoor: 80° F (27° C) D.B./67° F (19° C) W.B.; Outdoor: 95° F (35° C) D.B.
Heating | Indoor: 70° F (21° C) D.B.; Outdoor: 47° F (8° C) D.B./43° F (6° C) W.B.

*3 Airflow rate/sound pressure levels are at (Low-Mid-High).

*4 External static pressure is factory set to 0.06" W.G.

Ventilation Air: Providing sufficient ventilation air is an important part of every building design
ASHRAE Standard 62 provides the minimum air requirements. Also check local codes.

Specifications are subject to change without notice.

LIMITED WARRANTY | Seven-year compressor and one year parts. Extended warranty of up to 10 years is available. See our website for details on specific additional application installation coverage.



SPECIFICATIONS: PEFY ▼

CEILING-CONCEALED INDOOR UNIT

PEFY-P**NMAU-E3

Model Name			PEFY-P06NMAU-E3	PEFY-P08NMAU-E3	PEFY-P12NMAU-E3	PEFY-P15NMAU-E3	PEFY-P18NMAU-E3	PEFY-P24NMAU-E3
Power Source			208/230V, 1-Phase, 60Hz					
Cooling Capacity		Btu/h *1	6,000	8,000	12,000	15,000	18,000	24,000
Heating Capacity		Btu/h *1	6,700	9,000	13,500	17,000	20,000	27,000
Power Consumption	Cooling	W	60		90		110	170
	Heating	W	40		70		90	150
Current	Cooling	A	0.56/0.52		0.66/0.62	0.67/0.63	0.77/0.73	1.31/1.27
	Heating	A	0.45/0.41		0.55/0.51	0.56/0.52	0.66/0.62	1.20/1.16
External Finish			Galvanized Steel Sheet					
Dimensions	Height	In.	9-7/8					
	Width	In.	27-9/16			35-7/16		43-5/16
	Depth	In.	28-7/8					
Net Weight	Unit	Pounds	49			58	67	
Heat Exchanger			Cross Fin (Aluminum plate fin and copper tube)					
Fan	Type x Quantity		Sirocco Fan x 1					Sirocco Fan x 2
	Airflow Rate *2	CFM	212 - 265 - 300		265 - 318 - 371	353 - 424 - 494	424 - 512 - 600	618 - 742 - 883
	External Static Pressure	In. W.G.	0.14 - 0.20 - 0.28 - 0.40 - 0.60					
	Motor Type		Direct-driven DC Brushless Motor					
Air Filter			Polypropylene Honeycomb					
Refrigerant Pipe Dimensions	Liquid (High Pressure) (Braze)	In.	1/4					3/8
	Gas (Low Pressure) (Braze)	In.	1/2					5/8
Drain Pipe Dimension (O.D.)		In.	1-1/4"					
Sound Pressure Levels	Lo-Mid-Hi	dB(A)	26 - 28 - 29		28 - 30 - 34		26 - 28 - 29	

Model Name			PEFY-P27NMAU-E3	PEFY-P30NMAU-E3	PEFY-P36NMAU-E3	PEFY-P48NMAU-E3	PEFY-P54NMAU-E3
Power Source			208/230V, 1-Phase, 60Hz				
Cooling Capacity		Btu/h *1	27,000	30,000	36,000	48,000	54,000
Heating Capacity		Btu/h *1	30,000	34,000	40,000	54,000	60,000
Power Consumption	Cooling	W	170		240	340	360
	Heating	W	150		220	320	340
Current	Cooling	A	1.31/1.27		1.50/1.46	2.08/2.04	2.24/2.2
	Heating	A	1.20/1.16		1.39/1.35	1.97/1.93	2.13/2.09
External Finish			Galvanized Steel Sheet				
Dimensions	Height	In.	9-7/8				
	Width	In.	43-5/16		55-1/8		63
	Depth	In.	28-7/8				
Net Weight	Unit	Pounds	67		86		93
Heat Exchanger			Cross Fin (Aluminum plate fin and copper tube)				
Fan	Type x Quantity		Sirocco Fan x 2				
	Airflow Rate *2	CFM	618 - 742 - 883		812 - 989 - 1,165	989 - 1,201 - 1,412	1,042 - 1,254 - 1,483
	External Static Pressure	In. W.G.	0.14 - 0.20 - 0.28 - 0.40 - 0.60				
	Extended Static Motor Type		Direct-driven DC Brushless Motor				
Air Filter			Polypropylene Honeycomb				
Refrigerant Pipe Dimensions	Liquid (High Pressure) (Braze)	In.	3/8				
	Gas (Low Pressure) (Braze)	In.	5/8				
Drain Pipe Dimension (O.D.)		In.	1-1/4				
Sound Pressure Levels	Lo-Mid-Hi	dB(A)	28 - 30 - 34v		32 - 37 - 41	35 - 40 - 44	36 - 41 - 45

Notes:

*1 Cooling/Heating Capacity indicates the maximum value at operation under the following conditions:
 Cooling | Indoor: 80° F (27° C) D.B./67° F (19° C) W.B.; Outdoor 95° F (35° C) D.B.
 Heating | Indoor: 70° F (21° C) D.B.; Outdoor: 45° F (7° C) D.B./43° F (6° C) W.B.

*2 Airflow rate/sound pressure levels are at Low-Mid-Hi.

Ventilation Air: Providing sufficient ventilation air is an important part of very building design
 ASHRAE Standard 62 provides the minimum air requirements. Also check local codes.

Specifications are subject to change without notice.
LIMITED WARRANTY | Seven-year compressor and one year parts. Extended warranty of up to 10 years is available. See our website for details on specific additional application installation coverage.



SPECIFICATIONS: PEFY ▼

CEILING-CONCEALED INDOOR UNIT

PEFY-PNMH(S)U-E(2)**

Model Name			PEFY-P15NMHU-E2	PEFY-P18NMHU-E2	PEFY-P24NMHU-E2	PEFY-P27NMHU-E2	PEFY-P30NMHU-E2
Power Source			208/230V, 1-phase, 60Hz				
Cooling Capacity *1	Btu/h		15,000	18,000	24,000	27,000	30,000
Heating Capacity *1	Btu/h		17,000	20,000	27,000	30,000	34,000
Power Consumption	Cooling	W	270/280	270/280	330/320	390	450
	Heating	W	250/260	250/260	310/300	370	430
Current	Cooling	A	1.32/1.25	1.32/1.25	1.61/1.43	1.90/1.73	2.20/2.00
	Heating	A	1.21/1.14	1.21/1.14	1.50/1.32	1.79/1.62	2.09/1.89
External Finish			Unit: Galvanized Steel Plate				
Dimensions	Height	In.	15	15	15	15	15
	Width	In.	29-3/8	29-3/8	29-3/8	40-9/16	40-9/16
	Depth	In.	35-7/16	35-7/16	35-7/16	35-7/16	35-7/16
Net Weight	Unit	Pounds	98	98	100	124	124
Heat Exchanger			Cross Fin (Aluminum Plate Fin and Copper Tube)				
Fan	Type x Quantity		Sirocco Fan x 1	Sirocco Fan x 1	Sirocco Fan x 1	Sirocco Fan x 1	Sirocco Fan x 2
	Airflow Rate *2	CFM	353 - 494	353 - 494	477 - 671	547 - 777	636 - 883
	Ext. Static Pressure (208/230V)	In. W.G.	0.40 - 1.00/0.60 - 1.00				
	Motor Type		Single-phase Induction Motor				
Air Filter			Optional Part				
Refrigerant Pipe Dimensions	Liquid (High Pressure) (Flare)	In.	1/4	1/4	3/8	3/8	3/8
	Gas (Low Pressure) (Flare)	In.	1/2	1/2	5/8	5/8	5/8
Drain Pipe Dimension (O.D.)	In.	1 - 1/4	1 - 1/4	1 - 1/4	1 - 1/4	1 - 1/4	
Sound Pressure Levels (Low-High) *2	dB(A) at 230V		39 - 45	39 - 45	40 - 46	38 - 44	38 - 43

Model Name			PEFY-P36NMHU-E2	PEFY-P48NMHU-E2	PEFY-P54NMHU-E2	PEFY-P72NMHSU-E	PEFY-P96NMHSU-E	
Power Source			208/230V, 1-phase, 60Hz					
Cooling Capacity *1	Btu/h		36,000	48,000	54,000	72,000	96,000	
Heating Capacity *1	Btu/h		40,000	54,000	60,000	80,000	108,000	
Power Consumption	Cooling	W	620/610	620/610	630/620	63	82	
	Heating	W	600/590	600/590	610/600	63	82	
Current	Cooling	A	3.10/2.74	3.10/2.74	3.11/2.78	3.67/3.32	4.89/4.43	
	Heating	A	2.99/2.63	2.99/2.63	3.00/2.67	3.67/3.32	4.89/4.43	
External Finish			Unit: Galvanized Steel Plate					
Dimensions	Height	In.	15	15	15	18-9/16		
	Width	In.	47-1/16	47-1/16	47-1/16	49-1/4		
	Depth	In.	35-7/16	35-7/16	35-7/16	44-1/8		
Net Weight	Unit	Pounds	153	153	157	214	221	
Heat Exchanger			Cross Fin (Aluminum Plate Fin and Copper Tube)					
Fan	Type x Quantity		Sirocco Fan x 2	Sirocco Fan x 2	Sirocco Fan x 2	Sirocco Fan x 2	Sirocco Fan x 2	
	Airflow Rate *2	CFM	936 - 1,342	936 - 1,342	989 - 1,412	1,766 - 2,154 - 2,542	2,048 - 2,507 - 2,966	
	Ext. Static Pressure (208/230V)	In. W.G.	0.40 - 1.00/0.60 - 1.00				0.20 - 0.40 - 0.60 - 0.80 - 1.00	
	Motor Type		Single-phase Induction Motor				DC Motor	
Air Filter			Optional Part					
Refrigerant Pipe Dimensions	Liquid (High Pressure)	In.	3/8 (Flare)	3/8 (Flare)	3/8 (Flare)	3/8 (Brazed)	3/8 (Brazed)	
	Gas (Low Pressure)	In.	5/8 (Flare)	5/8 (Flare)	5/8 (Flare)	3/4 (Brazed)	7/8 (Brazed)	
Drain Pipe Dimension (O.D.)	In.	1-1/4	1-1/4	1-1/4	1-1/4	1-1/4		
Sound Levels *2 (Low-High or Low-Mid-High)	dB(A) at 230V		40 - 46	40 - 46	41 - 47	36 - 39 - 43	39 - 42 - 46	

Notes:

*1 Cooling/Heating capacity indicates the maximum value at operation under the following conditions:
 Cooling | Indoor: 80° F (27° C) D.B./67° F (19° C) W.B.; Outdoor: 95° F (35° C) D.B.
 Heating | Indoor: 70° F (21° C) D.B.; Outdoor: 47° F (8° C) D.B./43° F (6° C) W.B.

*2 Airflow rate/sound levels are at (Low-High or Low-Mid-High).

Ventilation Air: Providing sufficient ventilation air is an important part of every building design.

ASHRAE standard 62 provides the minimum ventilation air requirements. Also check local codes.

Specifications are subject to change without notice.

LIMITED WARRANTY | Seven-year compressor and one year parts. Extended warranty of up to 10 years is available. See our website for details on specific additional application installation coverage.



SPECIFICATIONS: PFFY-P-NEMU/NRMU ▼

FLOOR-STANDING INDOOR UNIT

PFFY-P**N(E,R)MU-E

Model			PFFY-P06NEMU-E	PFFY-P08NEMU-E	PFFY-P12NEMU-E	PFFY-P15NEMU-E	PFFY-P18NEMU-E	PFFY-P24NEMU-E
Power Source			208/230V, 1 Phase, 60Hz					
Cooling Capacity		Btu/h *1	6,000	8,000	12,000	15,000	18,000	24,000
Heating Capacity		Btu/h *1	6,700	9,000	13,500	17,000	20,000	27,000
Power Consumption	Cooling	W	51/61	51/61	55/67	65/78	78/93	96/114
	Heating	W	51/61	51/61	55/67	65/78	78/93	96/114
Current	Cooling	A	0.25/0.27	0.25/0.27	0.27/0.30	0.32/0.35	0.38/0.42	0.47/0.51
	Heating	A	0.25/0.27	0.25/0.27	0.27/0.30	0.32/0.35	0.38/0.42	0.47/0.51
External Finish (Munsell No.)			Acrylic Painted (5Y 8/1)					
Dimensions	Height	In.	24-13/16	24-13/16	24-13/16	24-13/16	24-13/16	24-13/16
	Width	In.	41-11/32	41-11/32	46-3/32	46-3/32	55-17/32	55-17/32
	Depth	In.	8-11/16	8-11/16	8-11/16	8-11/16	8-11/16	8-11/16
Net Weight	Unit	Pounds	67	67	71	73	84	89
Heat Exchanger			Cross Fin (Aluminum Plate Fin and Copper Tube)					
Fan	Type x Quantity		Sirocco Fan x 1	Sirocco Fan x 1	Sirocco Fan x 2	Sirocco Fan x 2	Sirocco Fan x 2	Sirocco Fan x 2
	Airflow Rate *2	CFM	194 – 229	194 – 229	247 – 317	300 – 388	353 – 459	353 – 494
	Motor Type		Single Phase Induction Motor					
	Motor Output	W	15	15	18	30	35	63
Air Filter			Standard Filter					
Refrigerant Pipe Dimension	Liquid (High Pressure) (Flare)	In.	1/4	1/4	1/4	1/4	1/4	3/8
	Gas (Low Pressure) (Flare)	In.	1/2	1/2	1/2	1/2	1/2	5/8
Drain Pipe Dimension		In.	O.D. 1-3/32					
Sound Levels *2	(Low-High)	dB(A)	36 – 41	36 – 41	37 – 41	38 – 43	38 – 43	40 – 46

Note:

*1 Cooling/Heating capacity indicates the maximum value at operation under the following conditions:
Cooling | Indoor: 80° F (27° C) D.B./67° F (19° C) W.B.; Outdoor: 95° F (35° C) D.B.

Heating | Indoor: 70° F (21° C) D.B.; Outdoor: 45° F (7° C) DB/43° F (6° C) W.B.

*2 Airflow rate/sound levels are at (Low-High)

Ventilation Air: Providing sufficient ventilation air is an important part of every building design
ASHRAE standard 62 provides the minimum ventilation air requirements.
Also check local codes.

Specifications are subject to change without notice.

LIMITED WARRANTY | Seven-year compressor and one year parts. Extended warranty of up to 10 years is available. See our website for details on specific additional application installation coverage.



Model			PFFY-P06NRMU-E	PFFY-P08NRMU-E	PFFY-P12NRMU-E	PFFY-P15NRMU-E	PFFY-P18NRMU-E	PFFY-P24NRMU-E
Power Source			208/230V, 1 Phase, 60Hz					
Cooling Capacity		Btu/h *1	6,000	8,000	12,000	15,000	18,000	24,000
Heating Capacity		Btu/h *1	6,700	9,000	13,500	17,000	20,000	27,000
Power Consumption	Cooling	W	51/61	51/61	55/67	65/78	78/93	96/114
	Heating	W	51/61	51/61	55/67	65/78	78/93	96/114
Current	Cooling	A	0.25/0.27	0.25/0.27	0.27/0.30	0.32/0.35	0.38/0.42	0.47/0.51
	Heating	A	0.25/0.27	0.25/0.27	0.27/0.30	0.32/0.35	0.38/0.42	0.47/0.51
External Finish (Munsell No.)			Galvanized Sheet Metal					
Dimensions	Height	In.	25-3/16	25-3/16	25-3/16	25-3/16	25-3/16	25-3/16
	Width	In.	34-29/32	34-29/32	39-5/8	39-5/8	49-1/16	49-1/16
	Depth	In.	8-11/16	8-11/16	8-11/16	8-11/16	8-11/16	8-11/16
Net Weight	Unit	Pounds	51	51	58	60	69	71
Heat Exchanger			Cross Fin (Aluminum Plate Fin and Copper Tube)					
Fan	Type x Quantity		Sirocco Fan x 1	Sirocco Fan x 1	Sirocco Fan x 2	Sirocco Fan x 2	Sirocco Fan x 2	Sirocco Fan x 2
	Airflow Rate *2	CFM	194 – 229	194 – 229	247 – 317	300 – 388	353 – 459	353 – 494
	Motor Type		Single Phase Induction Motor					
	Motor Output	kW	0.015	0.015	0.018	0.030	0.035	0.063
Air Filter			Standard Filter					
Refrigerant Pipe Dimension	Liquid (High Pressure) (Flare)	In.	1/4	1/4	1/4	1/4	1/4	3/8
	Gas (Low Pressure) (Flare)	In.	1/2	1/2	1/2	1/2	1/2	5/8
Drain Pipe Dimension		In.	O.D. 1-3/32					
Sound Levels *2	(Low-High)	dB(A)	36 – 41	36 – 41	37 – 41	38 – 43	38 – 43	40 – 46

Notes:

*1 Cooling/Heating capacity indicates the maximum value at operation under the following conditions:
Cooling | Indoor: 80° F (27° C) D.B./67° F (19° C) W.B.; Outdoor: 95° F (35° C) D.B.
Heating | Indoor: 70° F (21° C) D.B.; Outdoor: 45° F (7° C) D.B./43° F (6° C) W.B.

*2 Airflow rate/sound levels are at (Low-High).

Ventilation Air: Providing sufficient ventilation air is an important part of every building design
ASHRAE standard 62 provides the minimum ventilation air requirements.
Also check local codes.

Specifications are subject to change without notice.

LIMITED WARRANTY | Seven-year compressor and one year parts. Extended warranty of up to 10 years is available. See our website for details on specific additional application installation coverage.



SPECIFICATIONS: PVFY ▼

MULTI-POSITION AIR HANDLER

PVFY-P**NAMU-E1

Model Name			PVFY-P12NAMU-E1	PVFY-P18NAMU-E1	PVFY-P24NAMU-E1	PVFY-P30NAMU-E1	PVFY-P36NAMU-E1	PVFY-P48NAMU-E1	PVFY-P54NAMU-E1
Power Source			208/230V, 1-phase, 60Hz						
Cooling Capacity		Btu/h *1	12,000	18,000	24,000	30,000	36,000	48,000	54,000
Heating Capacity		Btu/h *1	13,500	20,000	27,000	34,000	40,000	54,000	60,000
Dimensions	Height	In.	50-1/4			54-1/4		59-1/2	
	Width	In.	17			21		25	
	Depth	In.	21-5/8						
Net Weight	Unit	Pounds	113			141		172	
Heat Exchanger			Cross fin (Aluminum fin and copper tube)						
Fan	Type x Qty.		Sirocco fan x 1						
	Airflow Rate *2	CFM	280 – 340 – 400	410 – 497 – 585	515 – 625 – 735	613 – 744 – 875	767 – 931 – 1,095	980 – 1,190 – 1,400	1,040 – 1,262 – 1,485
	External Static Pressure	In. W.G.	0.30 – 0.50 – 0.80 (selectable)						
	Motor Type		DC motor						
Filter			Polypropylene Honeycomb						
Refrigerant Pipe Dimensions	Liquid (High Pressure) (Braze)	In.	1/4			3/8			
	Gas (Low Pressure) (Braze)	In.	1/2			5/8			
Drain Pipe Dimensions		In.	3/4 FPT						
Sound Pressure Levels (As Measured in an Anechoic Room) *2	Pressure	dB(A)	27 – 31 – 35	28 – 32 – 36	30 – 34 – 38	32 – 36 – 40	35 – 39 – 43	35 – 39 – 43	36 – 40 – 44

Notes:

*1 Cooling/Heating capacity indicates the maximum value at operation under the following conditions:
 Cooling | Indoor: 80° F (27° C) D.B./67° F (19° C) W.B.; Outdoor: 95° F (35° C) D.B.
 Heating | Indoor: 70° F (21° C) D.B.; Outdoor: 47° F (8° C) D.B./43° F (6° C) W.B.

*2 Airflow rate/sound pressure levels are at (Low-Med-High).

Ventilation Air: Providing sufficient ventilation air is an important part of every building design. ASHRAE standard 62 provides the minimum ventilation air requirements. Also check local codes.

Specifications are subject to change without notice.

LIMITED WARRANTY | Seven-year compressor and one year parts. Extended warranty of up to 10 years is available. See our website for details on specific additional application installation coverage



SPECIFICATIONS: LOSSNAY® ENERGY ▼

ENERGY RECOVERY VENTILATOR (ERV)

LGH-F***RX5-E1

Model Name		LGH-F300RX5-E1							
Power source		208/230V, 1-phase, 60Hz							
Ventilation mode		Lossnay ventilation				Bypass ventilation			
Speed		Extra high	High	Low	Extra Low	Extra high	High	Low	Extra Low
Current	A	1.33/1.35	1.12/1.18	0.81/0.86	0.32/0.36	1.33/1.35	1.12/1.18	0.81/0.86	0.32/0.36
Input	W	274/300	232/268	168/197	67/82	274/300	232/268	168/197	67/82
Air volume	CFM	300/300	260/300	203/235	91/112	300/300	260/300	203/235	91/112
External static pressure	In. W.G.	0.60/0.78	0.46/0.54	0.28/0.33	0.06/0.08	0.60/0.78	0.46/0.54	0.28/0.33	0.06/0.08
Temperature recovery efficiency (%)		65.5/65.5	67.5/65.5	71/69	81/79	-	-	-	-
Enthalpy recovery efficiency (%)	Heating	63/63	65/63	68/66	79/77	-	-	-	-
	Cooling	50/50	52/50	55/53	63/61	-	-	-	-
Sound Pressure (Measured at 1.5m under level the center of the unit)	dB(A)	34/37	30.5/33	25.5/27.5	18/18	35/37.5	31.5/34.5	25.5/28.5	18/18.5
Weight	Pounds	73							
Starting current		2.5A							
Filter Specification		Standard Filter Provided (MERV 6)							

Model Name		LGH-F470RX5-E1							
Power source		208/230V, 1-phase, 60Hz							
Ventilation mode		Lossnay ventilation				Bypass ventilation			
Speed		Extra high	High	Low	Extra Low	Extra high	High	Low	Extra Low
Current	A	2.40/2.50	2.10/2.20	1.59/1.71	0.60/0.64	2.40/2.50	2.10/2.20	1.59/1.71	0.60/0.64
Input	W	485/538	425/490	330/393	120/145	485/538	425/490	330/393	120/145
Air volume	CFM	470/470	420/470	330/365	147/177	470/470	420/470	330/365	147/177
External static pressure	In. W.G.	0.80/0.96	0.54/0.66	0.33/0.40	0.07/0.09	0.80/0.96	0.54/0.66	0.33/0.40	0.07/0.09
Temperature recovery efficiency (%)		69/69	70.5/69	74/72	82/80	-	-	-	-
Enthalpy recovery efficiency (%)	Heating	64/64	66/64	70/68	80/78	-	-	-	-
	Cooling	51/51	53/51	58/55	69/67	-	-	-	-
Sound Pressure (Measured at 1.5m under level the center of the unit)	dB(A)	36/38	33/35.5	28.5/31	18/18.5	36/39	33/36	28.5/31.5	18/18
Weight	Pounds	119							
Starting current		4.5A							
Filter Specification		Standard Filter Provided (MERV 6)							

Specifications are subject to change without notice.

LIMITED WARRANTY | Seven-year compressor and one year parts. Extended warranty of up to 10 years is available. See our website for details on specific additional application installation coverage

SPECIFICATIONS: LOSSNAY® ENERGY ▼

ENERGY RECOVERY VENTILATOR (ERV)

LGH-F***RX5-E1

Model		LGH-F600RX5-E1							
Power source		208/230V, 1-phase, 60Hz							
Ventilation mode		Lossnay ventilation				Bypass ventilation			
Speed		Extra high	High	Low	Extra Low	Extra high	High	Low	Extra Low
Current	A	2.80/2.90	2.50/2.70	1.56/1.69	0.72/0.79	2.80/2.90	2.50/2.70	1.56/1.69	0.72/0.79
Input	W	577/637	517/605	324/387	146/180	577/637	517/605	324/387	146/180
Air volume	CFM	600/600	520/600	370/430	200/235	600/600	520/600	370/430	200/235
External static pressure	In. W.G.	0.56/0.80	0.48/0.48	0.24/0.24	0.07/0.07	0.56/0.80	0.48/0.48	0.24/0.24	0.07/0.07
Temperature recovery efficiency (%)		67/67	68/67	75/73	80/78	-	-	-	-
Enthalpy recovery efficiency (%)	Heating	64/64	65/64	71/68	79/77	-	-	-	-
	Cooling	50/50	53/50	59/56	68/67	-	-	-	-
Sound Pressure (Measured at 1.5m under level the center of the unit)	dB(A)	36/38	34/36.5	26.5/29	19/21	37/39	35/37.5	27/30	18.5/20
Weight	Pounds	132							
Starting current		5.0A							
Filter Specification		Standard Filter Provided (MERV 6)							

Model		LGH-F1200RX5-E1					
Power source		208/230V, 1-phase, 60Hz					
Ventilation mode		Lossnay ventilation			Bypass ventilation		
Speed		Extra high	High	Low	Extra high	High	Low
Current	A	5.7/5.8	5.0/5.3	3.1/3.4	5.8/5.8	5.1/5.4	3.1/3.4
Input	W	1185/1303	1040/1219	639/765	1185/1303	1040/1219	639/765
Air volume	CFM	1200/1200	1012/1200	695/824	1200/1200	1012/1200	695/824
External static pressure	In. W.G.	0.43/0.75	0.43/0.43	0.20/0.20	0.43/0.75	0.43/0.43	0.20/0.20
Temperature recovery efficiency (%)		67/67	68/67	75/73			
Enthalpy recovery efficiency (%)	Heating	64/64	65/64	71/68			
	Cooling	50/50	53/50	59/56			
Sound Pressure (Measured at 1.5m under level the center of the unit)	dB(A)	38/40.5	36/39	29/32	40/42.5	38/41	30.5/33.5
Weight	Pounds	265					
Starting current		10.0A					
Filter Specification		Standard Filter Provided (MERV 6)					

Specifications are subject to change without notice.

LIMITED WARRANTY | Seven-year compressor and one year parts. Extended warranty of up to 10 years is available. See our website for details on specific additional application installation coverage.



SPECIFICATIONS: DEDICATED OUTDOOR AIR SYSTEMS

PEFY-AF

Model Name			PEFY-AF1200CFM	PEFY-AF1200CFMR
Power Source			208/230V, 1 Phase, 60Hz	
Cooling Capacity	Btu/h *1		112,000	112,000
Heating Capacity	Btu/h *1		61,400	61,400
Reheat Capacity	Btu/h		-	24,200
Power Consumption	Cooling	W	660/780	
	Heating	W	660/780	
Current	Cooling	A	3.19/3.45	
	Heating	A	3.19/3.45	
External Finish			Galvanized	
Dimensions	Height	In.	18-9/16	
	Width	In.	49-1/4	
	Depth	In.	55-1/8	
Net Weight	Unit	Pounds	287	309
Heat Exchanger			Cross Fin (Aluminum Plate Fin and Copper Tube)	
Fan	Type x quantity		Sirocco Fan x 2	
	Airflow Rate *2	CFM	1,200	
	External Static Pressure	In. WG	0.40 - 0.60 - 0.88 (208V)	0.28 - 0.48 - 0.80 (208V)
			0.64 - 0.80 - 1.04 (230V)	0.52 - 0.72 - 0.96 (230V)
Motor Type		Single-phase Induction Motor		
Air Filter			Field Supply	
Main Coil Refrigerant Pipe Dimensions	Liquid (High Pressure) (Flare)	In.	3/8	
	Gas (Low Pressure) (Flare)	In.	7/8	
Reheat Coil Refrigerant Pipe Dimensions	Liquid (High Pressure) (Flare)	In.	—	7/8
	Gas (Low Pressure) (Flare)	In.	—	3/8
Drain Pipe Dimension (O.D.)		In.	1-1/4 x 2	
Sound Pressure Level *3	Low-Mid-High	dB(A)	36-38-41 (208V)	
			39-41-43 (230V)	
Operating Temperature Range	Cooling		50° F WB to 95° F WB (109° F DB) (10° C WB to 35° C WB [43° C DB])	
	Heating		-4° F WB to +60° F WB (-20° C WB to +15.5° C WB)	
Connectable Outdoor Unit			PUHY-P120TLMU-A (-BS), PUHY-P120YLMU-A (-BS) PUHY-P120TKMU-A (-BS), PUHY-P120YKMU-A (-BS)	PURY-P120TLMU-A (-BS), PURY-P120YLMU-A (-BS) PURY-P120TKMU-A (-BS), PURY-P120YKMU-A (-BS)

Notes:

*1 Cooling/Heating Capacity indicates the maximum value at operation under the following conditions:

- Cooling | Entering Indoor Unit: 87° F (31° C) D.B./80° F (27° C) W.B.
- Cooling | Outdoor Unit: 87° F (31° C) D.B.
- Heating | Entering Indoor Unit: 32° F (0° C) D.B.
- Heating | Outdoor Unit: 32° F (0° C) D.B./28° F (-2° C) W.B.

Ventilation Air: Providing sufficient ventilation air is an important part of very building design
ASHRAE Standard 62 provides the minimum air requirements. Also check local codes.

Specifications are subject to change without notice.

LIMITED WARRANTY | Seven-year compressor and one year parts. Extended warranty of up to 10 years is available. See our website for details on specific additional application installation coverage





©2018 Mitsubishi Electric Trane US HVAC, LLC. All rights reserved. Mitsubishi Electric, Lossnay, and the three-diamond logo are trademarks of Mitsubishi Electric Corporation and Trane and the Trane logo are trademarks of Trane International Inc. CITY MULTI, kumo cloud and H2i are registered trademarks of Mitsubishi Electric US, Inc. All other product names mentioned herein are trademarks or registered trademarks of their respective owners.



For more information visit
www.trane.com/ductless

VRF-PRC054A-EN
05.2018



Please recycle.