

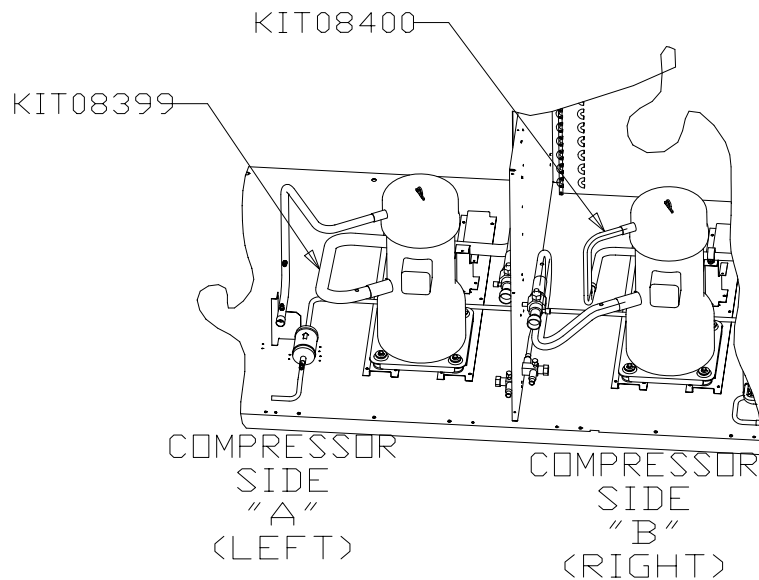

TRANE®

Installation

Compressor Replacement Kit for CSHB to CSHC Conversion, KIT08399 and KIT08400



Compressor replacement illustration for TTA240B

Models: CSHC, CSHB, TTA240B

Installation

Compressor Replacement Kit for CSHB to CSHC Conversion

Kit includes

Compressor side "A", KIT08399

1 - Suction tube, part number D670668G01

Compressor side "B", KIT08400

1 - Suction tube, part number D670669G01

1 - Discharge tube assembly, part number D670670G01

Instructions

1. Remove compressor by following compressor service guidelines.
2. Remove current suction and/or discharge tube from compressor.
3. Replace compressor and braze new tube(s) into new compressor.
 - It is important that a dry nitrogen purge is used while brazing.
 - Make sure not to overheat service valve. Use a wet rag to cool parts.
 - Add suction line filter when necessary.



Trane
A business of American Standard Companies
www.trane.com

For more information, contact your local district office or e-mail us at comfort@trane.com

Literature Order Number	PART-SVN33A-EN
File Number	SV-Compressors-PART-SVN33A-EN-0503
Supersedes	New
Stocking Location	Electronic Only

Trane has a policy of continuous product data and product improvement and reserves the right to change design and specifications without notice. Only qualified technicians should perform the installation and servicing of equipment referred to in this bulletin.