



Installation Instructions

Location of Parts

Motor Change Out Kit

KIT16337

Model Numbers:
CVHG

SAFETY WARNING

Only qualified personnel should install and service the equipment. The installation, starting up, and servicing of heating, ventilating, and air-conditioning equipment can be hazardous and requires specific knowledge and training. Improperly installed, adjusted or altered equipment by an unqualified person could result in death or serious injury. When working on the equipment, observe all precautions in the literature and on the tags, stickers, and labels that are attached to the equipment.

May 2020

PART-SVN157B-EN



© 2020 Trane

1

Warnings, Cautions, and Notices

Read this manual thoroughly before operating or servicing this unit. Safety advisories appear throughout this manual as required. Your personal safety and the proper operation of this machine depend upon the strict observance of these precautions.

The three types of advisories are defined as follows:

- WARNING** Indicates a potentially hazardous situation which, if not avoided, could result in death or serious injury.
- CAUTION** Indicates a potentially hazardous situation which, if not avoided, could result in minor or moderate injury. It could also be used to alert
- NOTICE** Indicates a situation that could result in equipment or property-damage only accidents.

Important Environmental Concerns

Scientific research has shown that certain man-made chemicals can affect the earth's naturally occurring stratospheric ozone layer when released to the atmosphere. In particular, several of the identified chemicals that may affect the ozone layer are refrigerants that contain Chlorine, Fluorine and Carbon (CFCs) and those containing Hydrogen, Chlorine, Fluorine and Carbon (HCFCs). Not all refrigerants containing these compounds have the same potential impact to the environment. Trane advocates the responsible handling of all refrigerants-including industry replacements for CFCs such as HCFCs and HFCs.

Important Responsible Refrigerant Practices

Trane believes that responsible refrigerant practices are important to the environment, our customers, and the air conditioning industry. All technicians who handle refrigerants must be certified according to local rules. For the USA, the Federal Clean Air Act (Section 608) sets forth the requirements for handling, reclaiming, recovering and recycling of certain refrigerants and the equipment that is used in these service procedures. In addition, some states or municipalities may have additional requirements that must also be adhered to for responsible management of refrigerants. Know the applicable laws and follow them.

2

WARNING

Proper Field Wiring and Grounding Required!
Failure to follow code could result in death or serious injury. All field wiring MUST be performed by qualified personnel. Improperly installed and grounded field wiring poses FIRE and ELECTROCUTION hazards. To avoid these hazards, you MUST follow requirements for field wiring installation and grounding as described in NEC and your local/state electrical codes.

WARNING

Personal Protective Equipment Required!
Installing/servicing this unit could result in exposure to electrical, mechanical and chemical hazards. Before installing/servicing this unit, technicians MUST put on all Personal Protective Equipment (PPE) recommended for the work being undertaken. ALWAYS refer to appropriate SDS sheets and OSHA guidelines for proper PPE. When working with or around hazardous chemicals, ALWAYS refer to the appropriate SDS sheets and OSHA guidelines for information on allowable personal exposure levels, proper respiratory protection and handling recommendations. If there is a risk of arc or flash, technicians MUST put on all necessary Personal Protective Equipment (PPE) in accordance with NFPA70E for arc/flash protection PRIOR to servicing the unit. Failure to follow recommendations could result in death or serious injury.

Some of these kits are intended for more than one size or type of unit and may contain additional parts not required for the particular unit in which the kit is being installed. Check the unit parts list if questions arise as to use of individual components.

3

Trane recommends using Loctite® 515 Gasket Eliminator on all refrigerant to atmospheric O-ring connections (except suction elbows to compressor connection) on centrifugal chillers using R-11, R-113, and R-123. Loctite 515 Gasket Eliminator is available from the Trane Company in 50-mL tubes (SEL00922) and 300-mL caulking tubes (SEL00376). Refer to KIT09237 for more information on Loctite and its installation. To ensure leak free joints after rebuild, apply Loctite 515 to grooved O-ring joints as follows:

- Inspect O-ring groove for nicks and scratches. Minor surface scratches or nicks can be repaired by filling the imperfection with a soft soldering material, then filing or sanding to a smooth finish.
- Apply a bead of Loctite 515 (1/8-in. dia. max) to the entire circumference of the bottom I.D. of the O-ring groove as shown in Figure 1.
- Place the O-ring into the groove and gently press it into sealant.

Note: O-rings should not be stretched more than 5 percent of their I.D. dimension once seated in the groove.

- Apply a bead of Loctite 515 (1/8-in. dia. max) to the entire circumference between the O-ring and top O.D. of the groove as shown in Figure 2.

Figure 1.

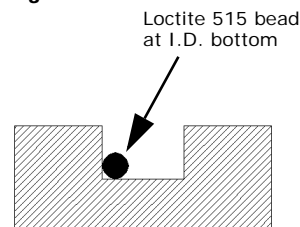

Figure 2.

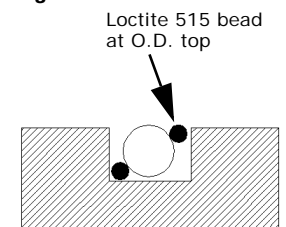

Table 1. 920 Compressor 142 Shells
Part numbers referenced in **Figure 3**

Part #	Qty.	Location and Use	Ref #
RNG02182	1	O-ring; volute to casing	1
RNG02082	2	O-ring; 1st stage tang assy	2
SEL00409	1	Oil seal; 1st stage tang assy	3
SHM00178 *	6	Shim; compressor 0.050 x 4.5	4
SHM00179 *	3	Shim; compressor 0.002 x 4.5	5
SHM00180 *	3	Shim; compressor 0.005 x 4.5	6
SHM00181 *	3	Shim; compressor 0.010 x 4.5	7
SHM00182 *	5	Shim; compressor 0.020 x 4.5	8
SHM00183 *	1	Shim; compressor 0.002 x 2.5	9
SHM00184 *	1	Shim; compressor 0.005 x 2.5	10
SHM00185 *	1	Shim; compressor 0.010 x 2.5	11
SHM00186 *	1	Shim; compressor 0.020 x 2.5	12
SHM00187 *	2	Shim; compressor 0.050 x 2.5	13
SHM00194 *	2	Shim; compressor 0.100 x 4.5	14
SPC00191 *	1	Shim; compressor 0.120/0.115 x 4.5	15
NUT00638	1	Nut; rotor shaft	16
WAS00488	1	Washer; rotor shaft	17
GKT04459	1	Gasket; 2nd stage tang assy.	18
GKT01319	1	Gasket; compressor	19
GKT01320	2	Gasket; compressor	20
RNG02145	1	O-ring; 1st stage tang assy.	21
RNG02136	1	O-ring; 1st stage casing	22
RNG02113 ^(a)	1	O-ring; motor housing	29
RNG02117 ^(b)	1	O-ring; motor housing	29

Part #	Qty.	Location and Use	Ref #
RNG02135	1	O-ring; 2nd stage casing	42
WAS01050	40	Washer; Ramp, 2 pieces = 1 pair	43
SCR02146	16	Screw; 0.25-20 x 0.75	44

(a) Use on 400/440 Frame Motors

(b) Use on 5000 Frame Motors

* Shims as required

Figure 3. Refer to Table 1 for part location and use

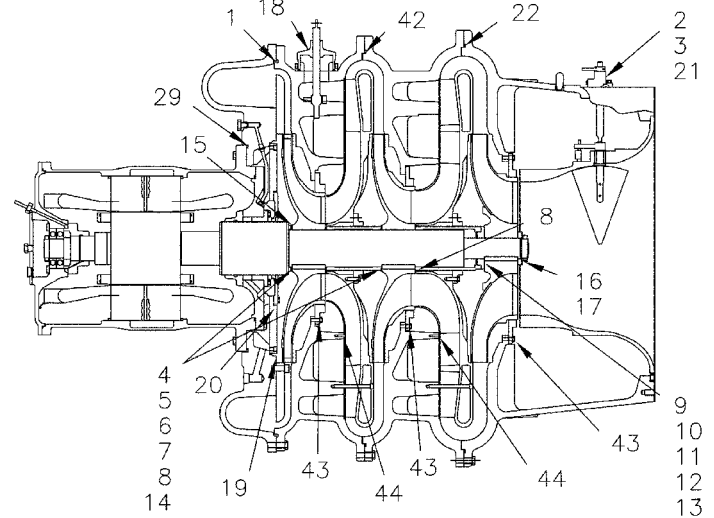
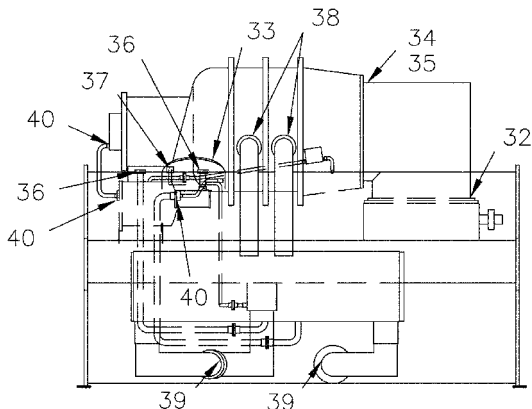

Table 2. 920 Compressor 142 Shells
Part numbers referenced in **Figure 4**

Part #	Qty.	Location and Use	Ref #
RNG02128	1	O-ring; suction elbow to evap	32
RNG02110	1	O-ring; volute to cond	33
GKT02694	2	Sealant; comp to suct elbow	34
RNG02130	1	O-ring; comp to suct elbow	35
GKT04416	2	Gasket; liquid tube to motor housing	36
GKT04402	2	Gasket; liquid tube to motor housing	37
GKT04431	2	Gasket; comp to econ pipe	38
GKT04434	2	Gasket; econ to cond and evap	39
GKT04402	3	Gasket; motor to oil tank	40

Figure 4. Refer to Table 2 for part location and use



Trane and the Trane logo are trademarks or registered trademarks of Trane in the United States and other countries. All trademarks referenced in this document are the trademarks of their respective owners.

Loctite is a registered trademark of Henkel Corporation.

Trane - by Trane Technologies (NYSE: TT), a global climate innovator - creates comfortable, energy efficient indoor environments for commercial and residential applications. For more information, please visit trane.com or tranetechnologies.com.

Trane has a policy of continuous product and product data improvement and reserves the right to change design and specifications without notice. We are committed to using environmentally conscious print practices.