

TCONT800AS11AA Touch Screen Programmable Comfort Control

18-HD25D18-3

INSTALLATION INSTRUCTIONS

APPLICATION

The TCONT800AS11AA Programmable Comfort Control provides electronic control of 24 Vac heating and cooling systems. See Table 1 for a general description.

Table 1. TCONT800AS11AA Comfort Control Description.

Power Method	Changeover	System Selection	Fan Selection	Comments
24 Vac common wire	Automatic or manual selectable	Heat-Off-Cool-Auto	On-Auto-Circ	System and Fan selection vary based on system type



RECYCLE NOTICE

If this control is replacing a control that contains mercury in a sealed tube, do not place your old control in the trash. Dispose of properly.

Contact your local waste management authority for instructions regarding recycling and the proper disposal of the old control.

INSTALLATION

When Installing this Product...

1. Read these instructions carefully. Failure to follow the instructions can damage the product or cause a hazardous condition.
2. Installer must be a trained, experienced service technician.
3. After completing installation, use these instructions to check out the product operation.

Selecting Location

Install the comfort control about 5 ft. (1.5m) above the floor in an area with good air circulation at average temperature. See Fig. 1.

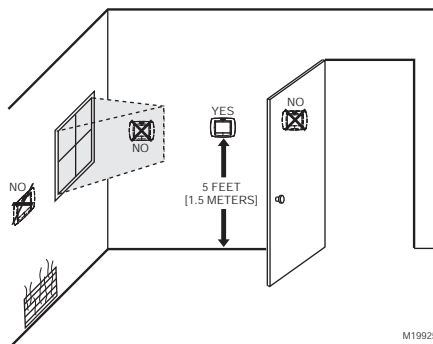

M19925

Fig. 1. Selecting comfort control location.

Do not install the comfort control where it can be affected by:

- Drafts or dead spots behind doors and in corners.
- Hot or cold air from ducts.
- Radiant heat from sun or appliances.
- Concealed pipes and chimneys.
- Unheated (uncooled) areas such as an outside wall behind the comfort control.

U.S. Patent No. #6595430, D509151 and Other Patents Pending

This thermostat contains a Lithium battery which may contain Perchlorate material. Due to State Law in California, the following statement is required:

Perchlorate Material—special handling may apply. See www.dtsc.ca.gov/hazardouswaste/perchlorate



69-1787-03

Installing Wallplate

CAUTION

Electrical Hazard.
Can cause electrical shock or equipment damage.
 Disconnect power before wiring.

The comfort control can be mounted horizontally on the wall or on a 4 in. x 2 in. (101.6 mm x 50.8 mm) wiring box.

1. Position and level the wallplate (for appearance only).
2. Use a pencil to mark the mounting holes.

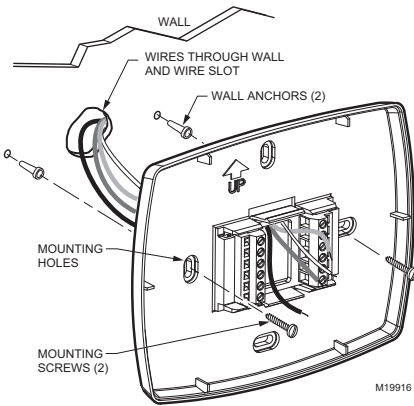

Fig. 2. Mounting wallplate.

3. Remove the wallplate from the wall and, if drywall, drill two 3/16-in. holes in the wall, as marked. For firmer material such as plaster, drill two 7/32-in. holes. Gently tap anchors (provided) into the drilled holes until flush with the wall.
4. Position the wallplate over the holes, pulling wires through the wiring opening. See Fig. 2.
5. Insert the mounting screws into the holes and tighten.

WIRING (FIG. 5-7)

All wiring must comply with local electrical codes and ordinances.

1. Select set of terminal identifications (Table 2) that corresponds with system type (conventional or heat

2. pump) in Fig. 3.
2. Loosen the screws for the appropriate system type selected; see Table 2. Insert wires in the terminal block under the loosened screw. See Fig. 4.
3. Securely tighten each screw.
4. Push excess wire back into the hole.
5. Plug the hole with nonflammable insulation to prevent drafts from affecting the comfort control.

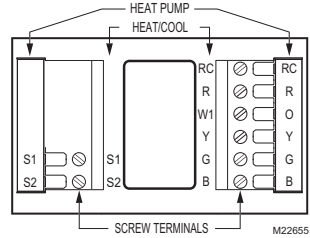

Fig. 3. Selecting terminal identifications for system type.

Table 2. Selecting Terminal Identifications for System Type.

System Type	Wallplate Terminal Identifications	Wiring Diagram Reference
Standard Heat/Cool	Heat/Cool	Fig. 5, Fig. 6
Heat Pump with No Auxiliary Heat	Heat Pump	Fig. 7

NOTE: The factory default setting is configured for a 1 heat/1cool system with a gas furnace.

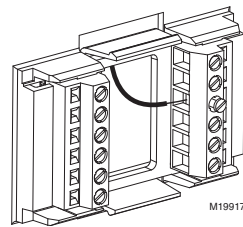
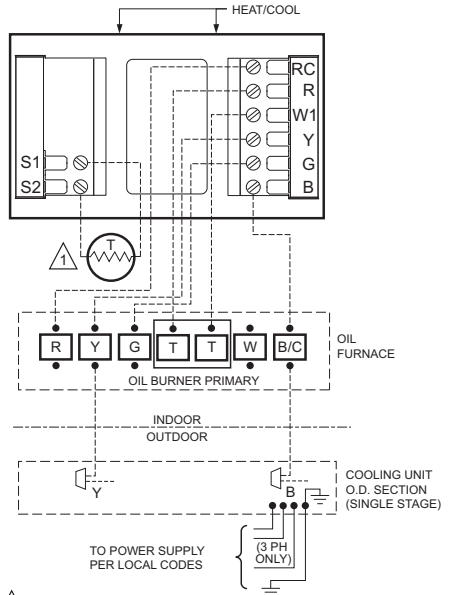
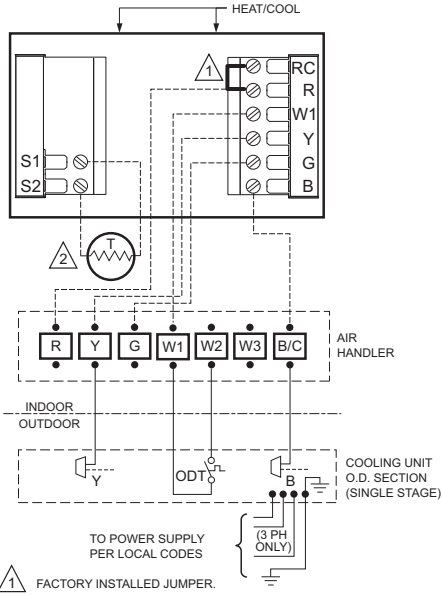

Fig. 4. Inserting wires in terminal block.

IMPORTANT

Use 18 gauge comfort control wire.



1 FACTORY INSTALLED JUMPER.
 2 OPTIONAL OUTDOOR OR INDOOR REMOTE SENSOR. AVAILABLE ON SELECT MODELS. WIRES MUST HAVE A CABLE SEPARATE FROM THE THERMOSTAT CABLE.

1 OPTIONAL OUTDOOR OR INDOOR REMOTE SENSOR. AVAILABLE ON SELECT MODELS. WIRES MUST HAVE A CABLE SEPARATE FROM THE THERMOSTAT CABLE.

M22656

M22657

Fig. 5. Typical hookup of single-stage heat and cool system with single transformer (1H/1C).

Fig. 6. Typical hookup of single-stage heat and cool system with two transformers (1H/1C).

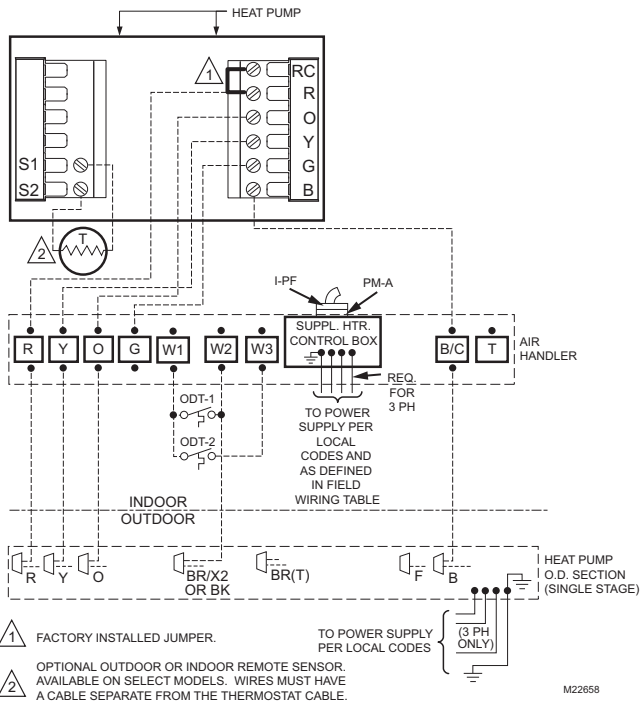

1 FACTORY INSTALLED JUMPER.
 2 OPTIONAL OUTDOOR OR INDOOR REMOTE SENSOR. AVAILABLE ON SELECT MODELS. WIRES MUST HAVE A CABLE SEPARATE FROM THE THERMOSTAT CABLE.

M22658

Fig. 7. Typical hookup of single-stage heat pump with no auxiliary/backup heat (1H/1C heat pump).

Powering the Comfort Control

The comfort control can be powered with 24 Vac.

24 Vac Common Power (Recommended)

Wire the common side of the transformer to the B screw of the comfort control wallplate. When installing in a single transformer system, keep the jumper wire between the R and Rc screws. When installing in a two-transformer system, use the common from the cooling transformer to connect to the B screw and remove the jumper wire between the R and Rc screws.

Battery Power (Optional)

⚠ CAUTION

Equipment or Property Damage Hazard. Using battery power only may not provide adequate power to comfort control and can cause damage during freezing conditions. Connect the 24 Vac Common (B) wire from the system transformer to the comfort control for proper operation when the battery power is drained.

Three AAA alkaline batteries can be used to power the comfort control for armchair programming only. To prevent the comfort control and heating/cooling system from shutting down due to lack of battery power, it is not recommended that the comfort control be solely powered with the three AAA batteries during normal system operation. When using batteries, make sure positive and negative terminals are oriented correctly, as marked on the device. See Fig. 8.

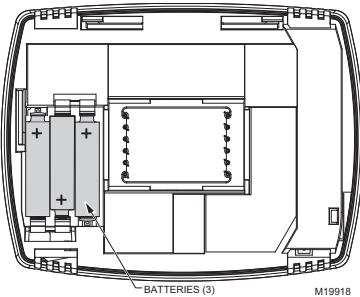

Fig. 8. Installing batteries on comfort control back.

Mounting the Comfort Control

1. Align the terminal screw blocks with the pins on the back of the comfort control.
2. Push the comfort control straight onto the wallplate. See Fig. 9.

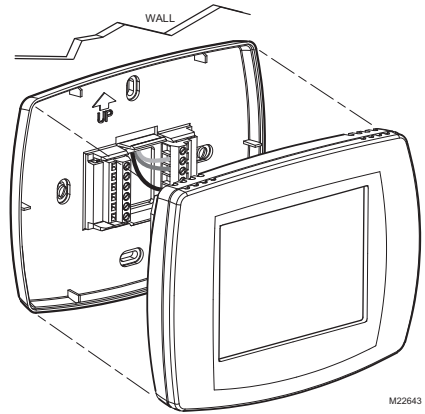

Fig. 9. Mounting comfort control on wallplate.

Adjusting Real-Time Clock

Setting Calendar and Time

Locate and remove the tab labeled *Remove* in the lower left corner on the comfort control back. The tab must be removed to activate the real-time clock. See Fig. 10.

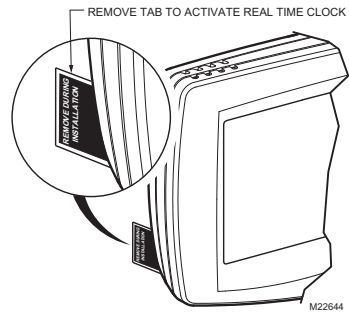

Fig. 10. Removing tab to activate real-time clock.

This comfort control is designed to automatically keep current time and day in memory for up to ten years under normal use after calendar is set. When comfort control is first powered, display is ready to enter calendar date. See Fig. 11.

OPERATION

System and Fan Settings

The System default setting is Heat and the Fan default setting is Auto.

SYSTEM Settings

Heat: controls heating system.

Off: both heating and cooling are off.

Cool: controls cooling system.

Auto: automatically changes between heating and cooling systems, depending on indoor temperature. (See Installer Setup section.)

FAN Settings

The Fan setting can be programmed into the comfort control schedule for each period (Wake, Leave, Return, Sleep). See the Owners' Guide for additional information.

Preprogrammed Settings

Table 3 shows the default program settings. See Owners' Guide for complete instructions on changing the program.

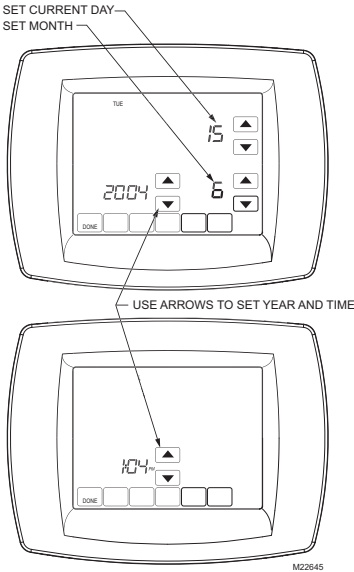

Fig. 11. Setting calendar and time after initial powerup.

IMPORTANT

The tab on back of comfort control in lower-left corner must be removed to activate this feature.

Using the Comfort Control

The comfort control has a touch screen interface. Words or symbols appear, highlighting keys, as needed, to complete tasks. Press keys with your fingertips. Sharp tips on pens or pencils can damage the comfort control.

1. Use arrow keys to set Year, Month and Day (see Fig. 11).
2. Press Done key.
3. Use arrow keys to set current time. See Fig. 11.
4. Press Done key.

Table 3. Default Program Settings.

Schedule Period	Time	Setpoints		Fan Setting
		Heat	Cool	
Wake	6:00AM	70°F (21°C)	78°F (25.5°C)	Auto
Leave	8:00AM	62°F (16.5°C)	85°F (29.5°C)	Auto
Return	6:00PM	70°F (21°C)	78°F (25.5°C)	Auto
Sleep	10:00PM	62°F (16.5°C)	82°F (28°C)	Auto

INSTALLER SETUP

The comfort control works with many different system types. To operate correctly, the comfort control must be set up to operate the installed heating and/or cooling system.

Follow these steps to enter the Installer Setup:

1. Be sure the comfort control is powered.
2. Press and release the System Key.

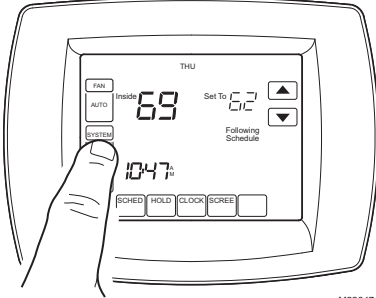

M22647

3. Press and hold the two blank keys on either side of the center blank key for approximately five seconds until screen changes.

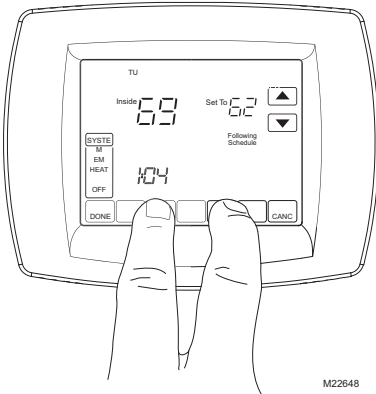

M22648

4. Release the two blank keys when the screen on the comfort control matches the screen below.

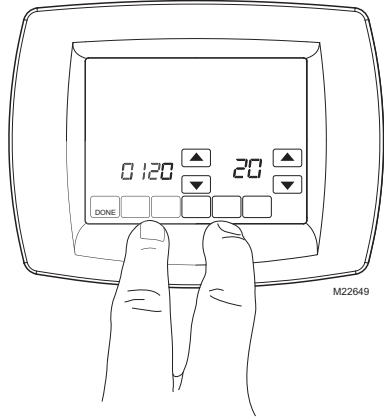

M22649

5. See screen below to review how the comfort control keys are used during Installer Setup. See Table 4 for Installer Setup Numbers and Settings.

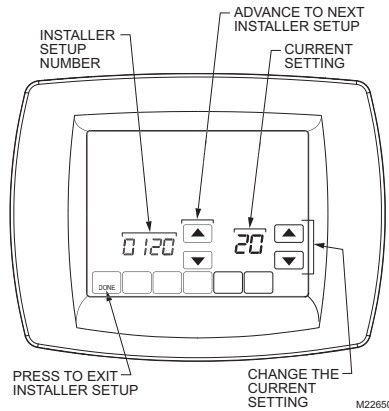

M22650

6. Press the Done key to exit the Installer Setup screen.

IMPORTANT

The Installer Setup Menu (Table 4) shows all available options. These options customize themselves as you make selections to Installer Setup. So not all Installer Setup Selections are shown or are available to change.

Table 4. Installer Setup Menu.

Select	Installer Setup Number	Factory Setting		Other Choices		Comments
		Option	Description	Options	Description	
Not used.	1 thru 0099	—	—	—	—	—
Date (Year Upper)	0120	20	Set first two digits of current calendar year (20 for year 2005, etc)	21	21 —first two digits of current calendar year (21xx)	2000 -2178 available
Date (Year Lower)	0130	05	Represents last two digits of current calendar year (2005).	00 -99	Select last two digits of current calendar year.	2000 -2178 available
Date (Month)	0140	6	Digit(s) represents current calendar month.	1-12	Select number that represents current calendar month.	—
Date (Day)	0150	15	Digit(s) represents current calendar date.	1-31	Select number that represents current calendar date.	—
Schedule Options	0160	4	7-day programming	0	0 —nonprogrammable	—
System Type Selection	0170	1	1 Heat/1 Cool System	1-6	1—1 heat/1 cool 2—single-stage heat pump (no aux. heat) 3—heat only (no fan) 4—heat only (with fan) 5—hot water Series 20 (3-wire or normally open zone valves) 6—cool only	Available options and defaults vary by comfort control. System selection automatically modifies some default settings and/or hides other Installer Setup options.
Fan Operation	0180	0	Heat/cool applications where equipment controls fan operation in heat mode.	1	Heat pump or electric heat applications where comfort control controls fan operation in heat mode.	Only shown if heat/cool system is selected. If heat pump is chosen, fan defaults to electric.
Cycles per hour (cph) for 1st Stage Compressor	0220	3	Compressor Stage 1 cycles per hour (cph)	1-6	1-6 available; 3 is recommended.	—
Cycles per hour (cph) for Heater Stage 1	0240	5	Heater Stage 1 cycles per hour (cph).	1-12	1-12 available; typical settings: 1—1 cph used for steam or gravity system. 3—3 cph used for 2-stage fossil fuel forced air systems or hot water systems. 5—5 cph used for single-stage fossil fuel forced air systems. 9—9 cph used for electric forced air heat systems (electric auxiliary heat for heat pump systems).	Not shown if system selection is heat pump. Selection in this stage changes default cph for 2nd stage heat.

Table 4. Installer Setup Menu. (Continued)

Select	Installer Setup Number	Factory Setting		Other Choices		Comments
		Option	Description	Options	Description	
Continuous Backlight	0280	0	Backlight not on continuously. Comfort control backlight comes on with each key press.	1	Backlight is on continuously (comfort control must have a common wire attached for this function).	Option is always shown; however, continuously on backlight works only if comfort control is wired with 24 Vac Common.
Changeover	0300	0	Manual changeover	1	1—auto changeover	—
Deadband	0310	3	Heating and cooling setpoints can be set no closer than 3°F (1.5°C)	2 thru 9	Heating and cooling setpoints can be set no closer than chosen value: 2—2°F (1°C) 3—3°F (2°C) 4—4°F (2.5°C) 5—5°F (3°C) 6—6°F (3.5°C) 7—7°F (4°C) 8—8°F (4.5°C) 9—9°F (5°C)	Shown only if automatic changeover is selected.
Temperature Indication Scale	0320	0	Temperature is displayed in °F.	1	Temperature is displayed in °C.	—
Daylight Savings	0330	1	Daylight savings enabled (use through 2006 and for areas that do not use the new 2007 DST calendar).	0,2	0—Daylight savings is disabled. 2—Daylight savings is enabled (start using in 2007, for areas that use the new 2007 DST calendar).	Set to 0 in areas that do not follow daylight savings.
Remote Temperature Sensor (Outdoor or Indoor)	0340	0	No remote temperature sensor	1,3	1—outdoor temperature sensor for display only. 3—indoor temperature sensor.	Defaults and Options depend on System Type selected. Indoor Temperature Sensor uses an averaging network and does not include on-board sensor.
Furnace Filter Change Reminder	0500	0	Furnace filter change reminder off	1-6	1—10 run time days 2—30 run time days 3—60 run time days 4—90 run time days 5—120 run time days 6—365 run time days	Run time based on call for fan.
Humidifier Pad Replacement Reminder	0510	0	Humidifier pad replacement reminder off	1-3	1—90 calendar days 2—180 calendar days 3—365 calendar days	—
Adaptive Intelligent Recovery™	0530	1	Adaptive Intelligent Recovery™ control is activated (system starts early so setpoint is reached by start of program period).	0	0—conventional recovery (system starts recovery at programmed time)	—

Table 4. Installer Setup Menu. (Continued)

Select	Installer Setup Number	Factory Setting		Other Choices		Comments
		Option	Description	Options	Description	
Number of Periods	0540	4	Four periods available (Wake, Leave, Return, Sleep)	2	Two periods available (Wake and Sleep)	Not shown if non-programmable is selected. 2 or 4 applies to all days of the week.
Minimum Compressor Off Time	0580	5	Five-minute minimum off time for compressor	0, 2, 3, 4	Minimum number of minutes compressor is off between calls for compressor	Five minutes recommended.
Heat Temperature Range Stop	0600	90	Highest heating setpoint.	40 to 89	Temperature range (1°F increments) of heating setpoint.	Shown in 1/2 °C.
Cool Temperature Range Stop	0610	50	Lowest cooling setpoint.	51 to 99	Temperature range (1°F increments) of cooling setpoint.	Shown in 1/2 °C.
Clock Format	0640	12	12-hour clock format	24	24-hour clock format	—
Extended Fan on time Heat	0650	0	No extended fan operation after call for heat ends	90	Fan operation is extended 90 seconds after call for heat ends.	Not shown if fan operation is set to fossil fuel or in Cool Only Systems
Extended Fan on time Cool	0660	0	No extended fan operation after call for cool ends	90	Fan operation is extended 90 seconds after call for cool ends.	Not shown in Heat Only Systems.
Keypad Lockout	0670	0	Unlocked keypad	1, 2	1—partially locked keypad 2—fully locked keypad	Unlocked—all functions are available. Partially locked—only temperature up and down keys and ability to enter and modify Installer Setup mode are available. Fully locked—only ability to enter and modify Installer Setup mode are available.

Table 4. Installer Setup Menu. (Continued)

Select	Installer Setup Number	Factory Setting		Other Choices		Comments
		Option	Description	Options	Description	
Temperature Control in Heat	0680	2	Standard temperature control in heating	1, 3	<p>1—less aggressive temperature control (could cause temperature undershoot)</p> <p>3—more aggressive temperature control (could cause temperature overshoot)</p>	<p>Applies to recovery ramp and use of auxiliary heat during recovery.</p> <p>Choose 1 if getting temperature overshoot.</p> <p>Choose 3 if getting temperature undershoot.</p>
Temperature Control in Cool	0690	2	Standard temperature control in cooling	1, 3	<p>1—less aggressive temperature control (could cause temperature undershoot)</p> <p>3—more aggressive temperature control (could cause temperature overshoot)</p>	<p>Applies to recovery ramp.</p> <p>Choose 1 if getting temperature overshoot.</p> <p>Choose 3 if getting temperature undershoot.</p>
Temperature Display Offset	0700	0	No difference in displayed temperature and actual room temperature	-3, -2, -1, 0, 1, 2, 3	<p>-3°F (-1.5°C)</p> <p>-2°F (-1°C)</p> <p>-1°F (-.5°C)</p> <p>0°F (0°C)</p> <p>1°F (.5°C)</p> <p>2°F (1°C)</p> <p>3°F (1.5°C)</p>	—
Reset Comfort Control	0710	0	No comfort control reset.	1	Resets all Installer Setup Options to default values and resets schedule to default setting.	Only calendar settings and time are retained.

SYSTEM CHECKOUT

Installer System Test

The Installer System Test mode is used to test the HVAC system(s). See Table 5. While in System Test mode, minimum off-time for compressors is bypassed.

The Installer Test is part of Installer Setup options. Enter Installer Setup screen and press Down arrow key to bring up test selection(s) quickly.

ADVANCED FEATURES

Outdoor or Indoor Temperature Sensor

For accuracy, the initial reading of the indoor or outdoor temperature sensor requires five minutes to stabilize. See the Sensor instructions for installation information.



CAUTION

Equipment Damage Hazard.
Minimum compressor off-time is bypassed during Installer System Test.

Avoid cycling compressor quickly.

Table 5. System Test(s).

Select	Installer Setup Number	Factory Setting		Other Choices		Comments
		Options	Description	Options	Description	
Installer Test Cool	Test 1	0	Cool is off	1	0—cool off 1—cool stage 1 turns on	System selection determines tests available and number of stages shown.
Installer Test Fan	Test 2	0	Fan is off	1	0—fan off 1—fan turns on	—
Installer Test Heat	Test 3	0	Heat is off	1	0—heat off 1—stage 1 heat on	—

TROUBLESHOOTING (SEE TABLE 6)**Table 6. Troubleshooting.**

Symptom	Possible Cause	Action
Display does not come on.	Comfort control is not being powered.	Check for 24 Vac between B and Rc.
Temperature settings do not change.	The upper or lower temperature limits were reached.	Check temperature setpoints. Check Installer Setup Numbers 0600 and 0610; modify.
	The keypad is fully locked.	Check Installer Setup Number 0670 to change keypad lock options.
Heating or cooling does not come on.	Comfort control minimum off-time is activated.	Wait up to five minutes for the system to respond.
	System selection is not set to Heat or Cool.	Set system Selection to correct position.
	System type Selection is incorrect.	Check Installer Setup Number 0170 and make sure correct System type is chosen.
Comfort control is calling for Heat (Heat on) or Cool (Cool on) but no heating or cooling is running.	Heating or cooling equipment is not operating.	Check wiring. Check Installer Setup Number 0170; verify correct system type is chosen. Verify equipment operation in System Test mode.
Comfort control does not respond when touchpad is pressed.	The keypad is locked.	Check Installer Setup Number 0670 to change keypad locked options.

