

CONDENSING SECTION

AIR HANDLER SECTION

TRANE
 THIS DRAWING IS PROPRIETARY AND SHALL NOT BE COPIED OR ITS CONTENTS DISCLOSED TO ANY PARTIES WITHOUT THE CONSENT OF TRANE.

FILE NUMBER:	2313-1923	DRAWING NUMBER:	2313-1928	SHEET:	1 OF 1	REV:	B
--------------	-----------	-----------------	-----------	--------	--------	------	---

ROOFTOP PACKAGED AIR CONDITIONER
 DIAGRAM
 CONNECTION - RACEWAY DEVICES
 RT 40-75 TON STANDARD
 CONNECTION 3 OF 3

AREA	DEVICE PREFIX	LOCATION CODE
1		INSIDE UNIT CONTROL BOX
2		CONDENSER SECTION
3		AIR HANDLER SECTION
4		HEATING SECTION
5		EXTERNAL FIELD MOUNTED DEVICE

- NOTES:
- 37 PLUGS J101, J102, J105, J116, J117, J118 AND J120 LOCATED IN MAIN CONTROL PANEL.
 - 52 2S4 & 2S5 ARE LOW PRESSURE CUTOFF SWITCHES USED FOR COMPRESSOR PROTECTION (25 PSIG). CAUTION !! DO NOT JUMPER ACROSS SWITCH UNDER ANY CIRCUMSTANCE.
 - 57 3U63 AND ASSOCIATED WIRING USED ON REFERENCE ENTHALPY AND COMPARATIVE ENTHALPY OPTIONS.
 - 61 COMP PROTECTION MODULES 2B7U1, 2B7U2, 2B8U3 AND 2B18U4 & ASSOCIATED WIRING ARE REQUIRED FOR 75 TON UNITS ONLY.
 - 62 WIRE 576A USED ONLY ON UNITS WITH OPTIONAL EXHAUST FAN WITHOUT STATITRAC. WIRE 602B USED ONLY ON UNITS WITH OPTIONAL RETURN FAN WITHOUT STATITRAC.

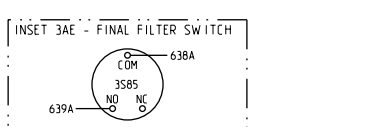
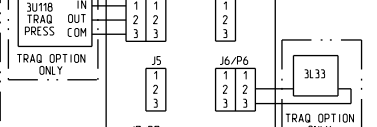
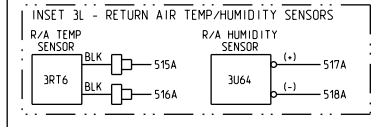
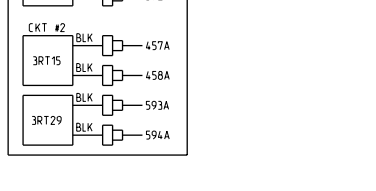
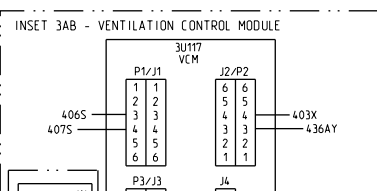
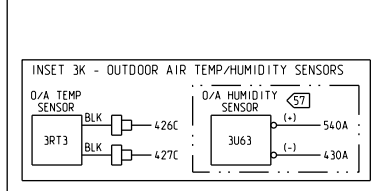
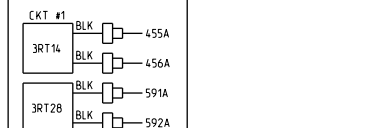
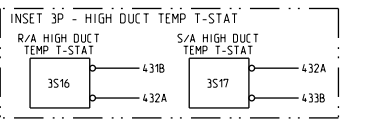
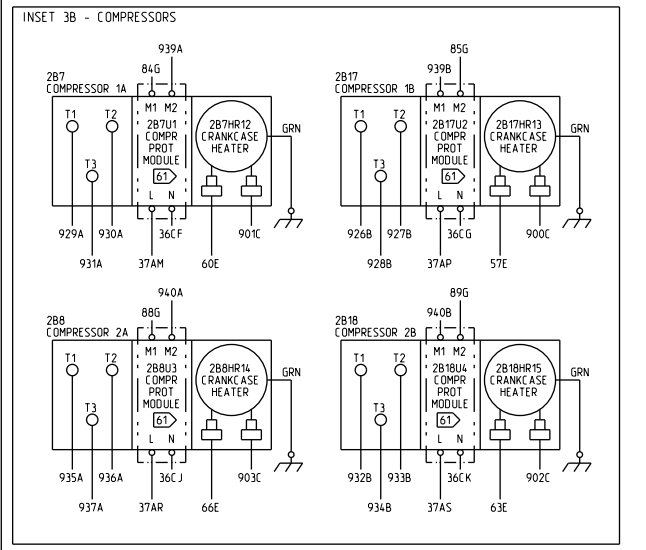
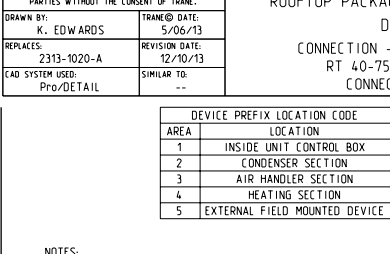
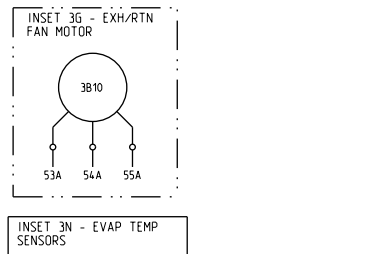
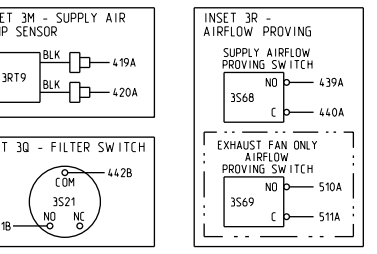
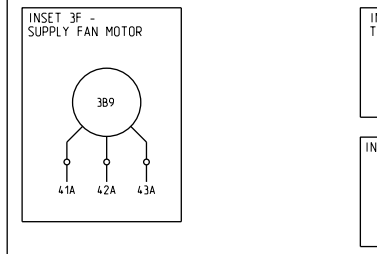
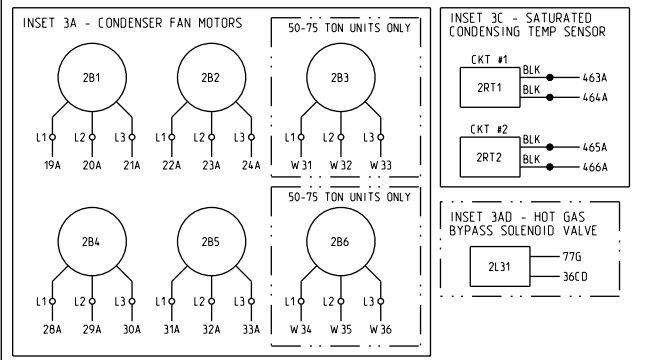

HEAT SECTION

