

CONDENSING SECTION

AIR HANDLER SECTION

TRANE  
 THIS DRAWING IS PROPRIETARY AND SHALL NOT BE COPIED OR ITS CONTENTS DISCLOSED TO ANY OTHER PARTIES WITHOUT THE CONSENT OF TRANE.

FILE NUMBER:	2307-9166	DRAWING NUMBER:	2307-9172	SHEET:	1 OF 1	REV	G
--------------	-----------	-----------------	-----------	--------	--------	-----	---

ROOFTOP PACKAGED AIR CONDITIONER  
 DIAGRAM  
 CONNECTION - RACEWAY DEVICES  
 RT 40-75 TON W / SUPPLY FAN V.F.D.  
 CONNECTION 3 OF 3

DEVICE PREFIX LOCATION CODE	
AREA	LOCATION
1	INSIDE UNIT CONTROL BOX
2	CONDENSER SECTION
3	AIR HANDLER SECTION
4	HEATING SECTION
5	EXTERNAL FIELD MOUNTED DEVICE

DRAWN BY: T.DEPRIEST  
 TRANE DATE: 09/25/08  
 REPLACES: 2309-3054  
 REVISION DATE: 5/15/12  
 CAD SYSTEM USED: Pro/DETAIL  
 SIMILAR TO: --

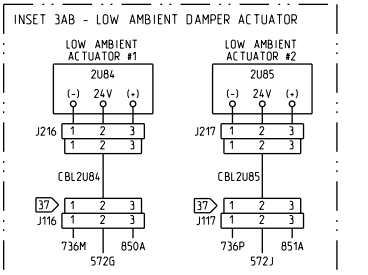
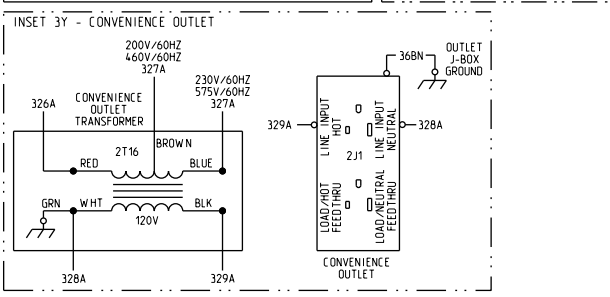
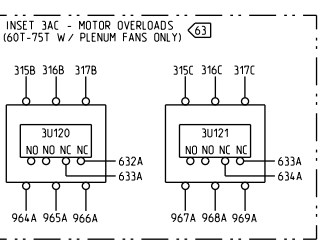
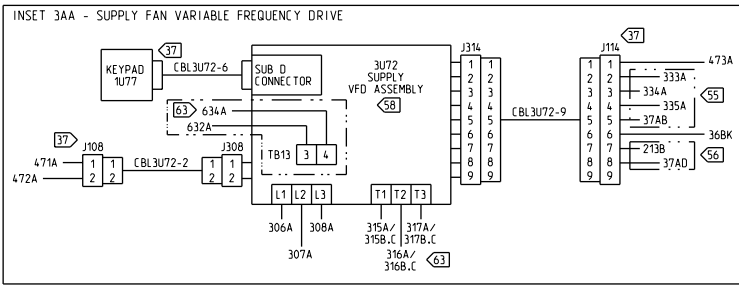
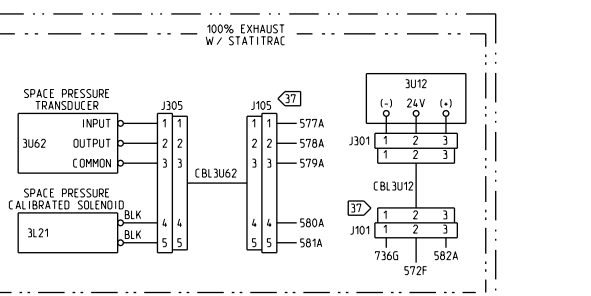
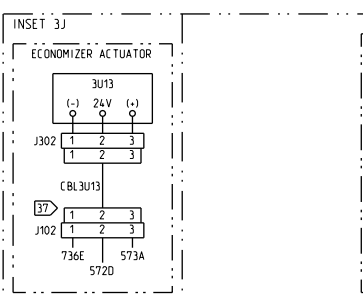
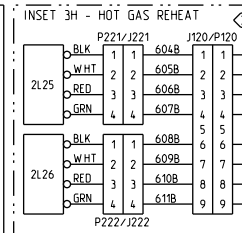
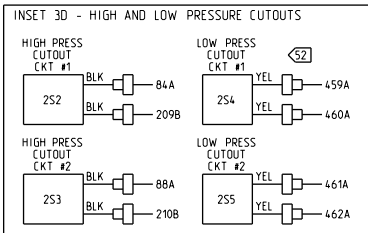
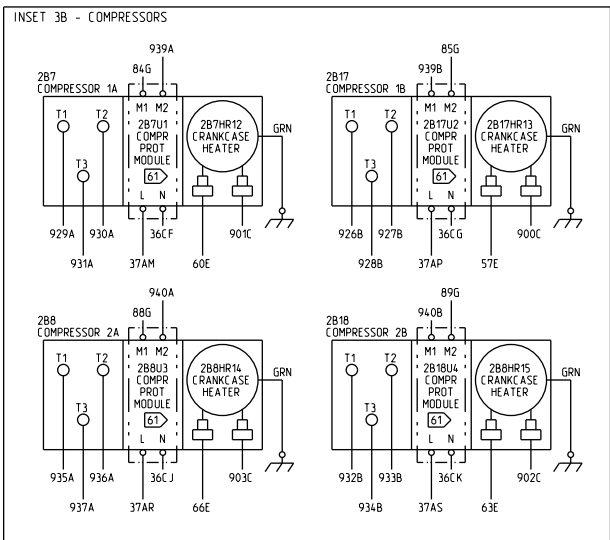
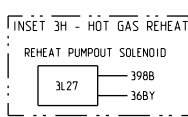
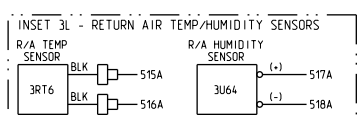
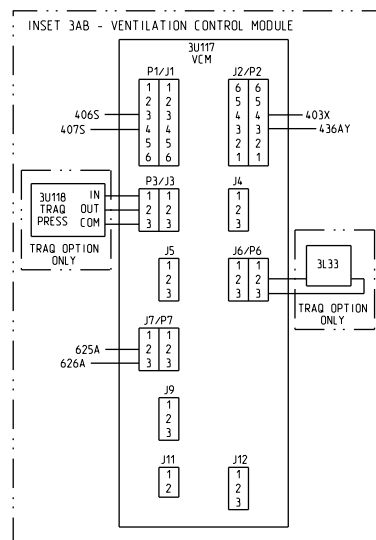
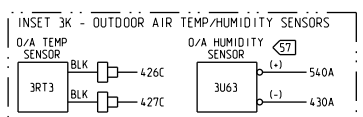
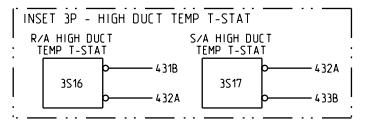
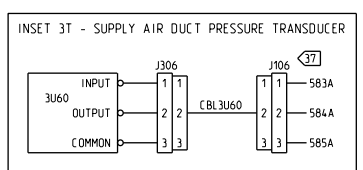
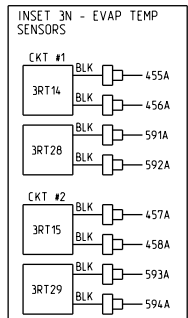
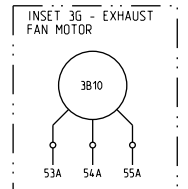
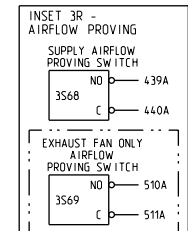
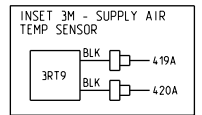
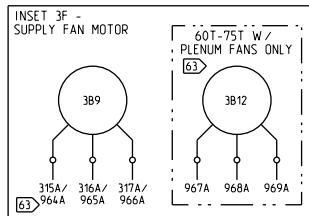
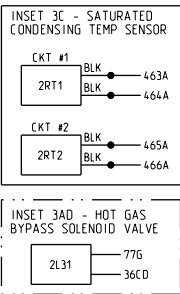
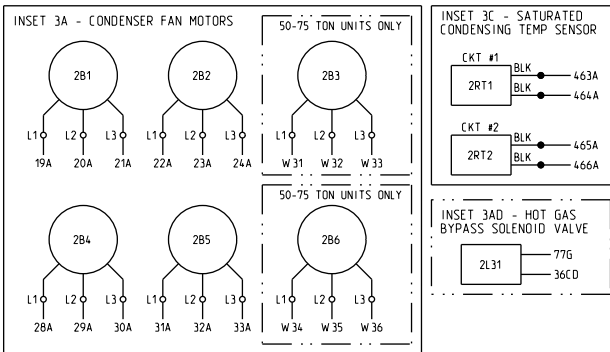

- NOTES:
- 37 PLUGS J101, J102, J105, J106, J114, J116, J117 AND J120 & VFD KEYPAD 1U77 LOCATED IN MAIN CONTROL PANEL.
  - 52 2S4 & 2S5 ARE LOW PRESSURE CUTOFF SWITCHES USED FOR COMPRESSOR PROTECTION (2S5 P.S.I.G). CAUTION !! DO NOT JUMPER ACROSS SWITCH UNDER ANY CIRCUMSTANCE.
  - 55 WIRES REQUIRED ONLY FOR V.F.D. WITH BYPASS OPTION.
  - 56 WIRES 213B & 37AD REQUIRED ONLY ON UNITS WITH GAS OR ELECTRIC HEAT.
  - 57 3U63 AND ASSOCIATED WIRING USED ON REFERENCE ENTHALPY AND COMPARATIVE ENTHALPY OPTIONS.
  - 58 SEE APPLICABLE VARIABLE FREQUENCY DRIVE DIAGRAM FOR BALANCE OF CIRCUIT.
  - 61 COMP. PROTECTION MODULES 2B7U1, 2B7U2, 2B8U3 AND 2B8U4 & ASSOCIATED WIRING ARE REQUIRED FOR 75 TON UNITS ONLY.
  - 63 MOTOR 3B12, OVERLOADS 3U120 AND 3U121, AND WIRES 315B, 315C, 316B, 316C, 317B, 317C, 632A, 633A, 634A, 964A, 965A, 966A, 967A, 968A AND 969A ARE USED ON 60T-75T UNITS WITH PLENUM FANS ONLY.

HEAT SECTION

