

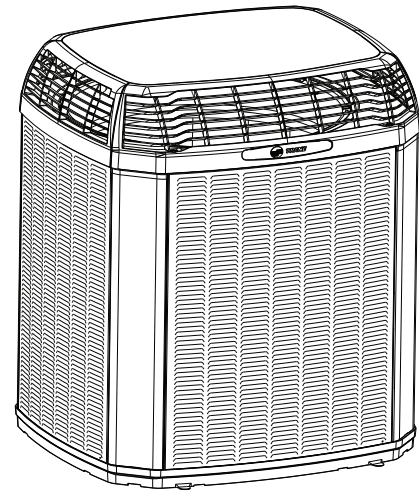


# Installer's Guide

## TRANE Link Variable Speed Heat Pumps and Air Conditioners

5TWW0X24A1000A  
5TWW0X36A1000A  
5TWW0X48A1000A  
5TWW0X60A1000A

5TTV0X24A1000A  
5TTV0X25A1000A  
5TTV0X36A1000A  
5TTV0X48A1000A  
5TTV0X60A1000A



The Diagnostics Mobile App is available by scanning a QR code above, the one located inside this unit or by searching for the Trane or American Standard Diagnostics App in your App Store®. This system must include a A/T HUI2360A200U thermostat and a TSYS2C60A2VVU system controller to operate and is Link communicating only.

**Note:** Graphics in this document are for representation only. Actual model may differ in appearance.

**Note:** This unit is Link communicating only.

**Note:** R-454B refrigerant is an "A2L" refrigerant meaning: A = non-toxic, 2 = flammable, L = low burning velocity. The term "A2L" is used throughout this document.

**Note:** This unit requires software version 9.0 or later on the SC360 and UX360.

### ⚠ SAFETY WARNING

Only qualified personnel should install and service the equipment. The installation, starting up, and servicing of heating, ventilating, and air-conditioning equipment can be hazardous and requires specific knowledge and training. Improperly installed, adjusted or altered equipment by an unqualified person could result in death or serious injury. When working on the equipment, observe all precautions in the literature and on the tags, stickers, and labels that are attached to the equipment.



# SAFETY SECTION

**Important** – This document contains a wiring diagram and service information. This is customer property and is to remain with this unit. Please return to service information pack upon completion of work.

**Note:** R454B refrigerant is a blend and should only be added to the system in liquid form.

## ⚠ WARNING

### HAZARDOUS VOLTAGE!

Failure to follow this Warning could result in property damage, severe personal injury, or death.

Disconnect all electric power, including remote disconnects before servicing. Follow proper lockout/tagout procedures to ensure the power cannot be inadvertently energized.

## ⚠ WARNING

### REFRIGERANT OIL!

Any attempt to repair a central air conditioning product may result in property damage, severe personal injury, or death.

Use only R-454B approved service equipment. All R-454B systems with variable speed compressors use variable speed compressor oil that readily absorbs moisture from the atmosphere. To limit this “hygroscopic” action, the system should remain sealed whenever possible. If a system has been open to the atmosphere for more than 4 hours, the compressor oil must be replaced. Never break a vacuum with air and always change the driers when opening the system for component replacement.

## ⚠ CAUTION

### HOT SURFACE!

May cause minor to severe burning. Failure to follow this Caution could result in property damage or personal injury.

Do not touch top of compressor.

## ⚠ CAUTION

### CONTAINS REFRIGERANT!

Failure to follow proper procedures can result in personal illness or injury or severe equipment damage.

System contains oil and refrigerant under high pressure. Recover refrigerant to relieve pressure before opening system.

## ⚠ WARNING

### P65 WARNING!

This product can expose you to chemicals including lead, which are known to the State of California to cause cancer and birth defects or other reproductive harm. For more information go to [www.P65Warnings.ca.gov](http://www.P65Warnings.ca.gov)

## ⚠ CAUTION

### GROUNDING REQUIRED!

Failure to inspect or use proper service tools may result in equipment damage or personal injury. Reconnect all grounding devices. All parts of this product that are capable of conducting electrical current are grounded. If grounding wires, screws, straps, clips, nuts, or washers used to complete a path to ground are removed for service, they must be returned to their original position and properly fastened.

## ⚠ WARNING

### SERVICE VALVES!

Failure to follow this warning will result in abrupt release of system charge and may result in personal injury and/or property damage. Extreme caution should be exercised when opening the Suction and Liquid Line Service Valve. Turn valve stem counterclockwise only until the stem contacts the rolled edge. No torque is required.

## ⚠ WARNING

### BRAZING REQUIRED!

IF BRAZING - Make certain that all joints are brazed, not soldered. IF USING MECHANICAL CONNECTIONS - Ensure leak test is negative. Failure to inspect lines or use proper service tools may result in equipment damage or personal injury.

## ⚠ WARNING

### HIGH LEAKAGE CURRENT!

Failure to follow this Warning could result in property damage, severe personal injury, or death.

Earth connection essential before connecting electrical supply.

**⚠ WARNING**  
**RISK OF FIRE!**  
 Flammable refrigerant used. To be repaired only by trained service personnel. Do not puncture refrigerant tubing.  
 Dispose of properly in accordance with federal or local regulations. Flammable refrigerant used.

**⚠ CAUTION**  
**WARNING!**  
 Use ONLY R-454B rated indoor models, service equipment and components with these units.

**⚠ WARNING**  
**VENTILATION!**  
 Ensure that the area is in the open or that it is adequately ventilated before breaking into the system or conducting any hot work.

**⚠ CAUTION**  
**RISK OF FIRE!**  
 Use three specified access points on outdoor unit to evacuate refrigerant when servicing compressor.

**Approved Controllers:**

- UX360 Smart Thermostat with SC360 System Controller.

**Approved Combinations for Variable Speed Units running in Link mode**


Link Indoor	Link Zoning
5TAMX	Yes
5TEMC	Yes
S8V2-C	Yes
Link Relay Panel	No

*Note: See AHRI directory for approved indoor and outdoor model combinations. Only Trane coils and air handlers are approved for use with variable speed outdoor unit.*

**Table 1. Operating Range**

Mode	Model	Operating Range
Cooling	2 – 5 Ton	55 °F – 120°F
Heating	2 – 5 Ton	0° F – 66°F


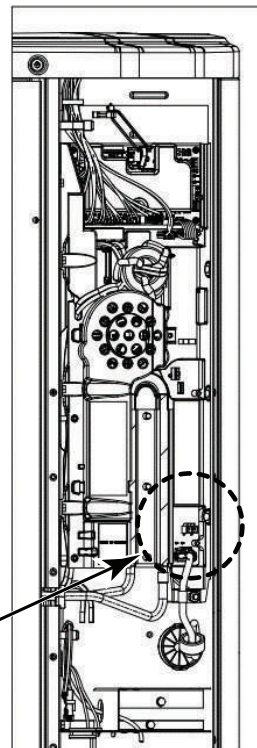
**⚠ WARNING**

  
**400 VOLTS  
 ELECTRICAL HAZARD**

Failure to follow this warning could result in personal injury or death.

WAIT TWO (2) MINUTES after disconnecting power prior to touching electrical components as they may hold a dangerous charge of 400VDC, then verify DC Voltage is less than 42 VDC at inverter test points labeled +DC and -DC before servicing board.

DC- DC+



## SAFETY SECTION

---

**Important:** Use caution when cleaning outdoor coil to ensure no water enters the electrical control compartment. When cleaning coil from inside the compressor compartment, take special care not to spray water towards the top rows of the coil near the

control panel. Water may enter the control compartment and drive damaging the electronics. Disconnect all electric power, including remote disconnects before servicing.



# Table of Contents

Unit Location Considerations.....	6	Electrical – Low Voltage	
Subcool Charging Correction		Communicating .....	24
Charts .....	10	Refrigerant Detection System	
R-454B Refrigerant Charging Chart.....	11	Guidelines .....	25
Refrigerant Properties.....	11	Electrical – High Voltage.....	26
Suggested Locations.....	13	Integrated Variable Speed Control Board	
Coastal Considerations.....	13	LED Indicators .....	27
Unit Preparation.....	14	Start Up .....	28
Setting Up the Unit .....	14	System Charge Adjustment .....	29
Refrigerant Line Considerations .....	15	Charging the Unit.....	30
Refrigerant Line Brazing.....	18	Charging Below 55° F Outdoor	
Refrigerant Line Leak Check .....	20	Temperature in Heating Mode.....	31
Refrigerant Line and Indoor Coil		Defrost Control (Heat Pump only).....	32
Evacuation.....	21	Checkout Procedures .....	33
Servicing .....	22	Symbols.....	34
Service Valves.....	23	Notices .....	35



# Unit Location Considerations

## Piping Guidelines

Piping material, pipe routing, and installation shall include protection from physical damage in operation and service, and be in compliance with national and local codes and standards. All field joints shall be

accessible for inspection prior to being covered or enclosed. Install of pipe work shall be kept to a minimum.

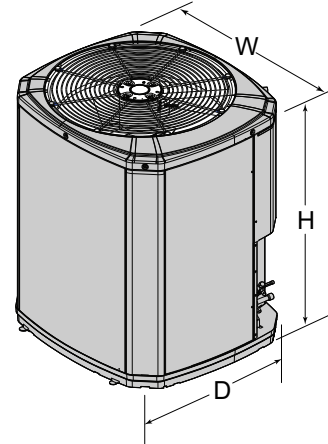
That provisions shall be made for expansion and contraction of long runs of piping.

**Table 2. Unit Dimensions and Weight**

Models	H x D x W (in)	Weight * (lb)
5TWV0X24A	46 x 30 x 33	192
5TWV0X36A	52 x 34 x 37	222
5TWV0X48A	52 x 34 x 37	242
5TWV0X60A	52 x 34 x 37	280
5TTV0X24A	46 x 30 x 33	187
5TTV0X25A	52 x 34 x 37	230
5TTV0X36A	52 x 34 x 37	265
5TTV0X48A	52 x 34 x 37	265
5TTV0X60A	52 x 34 x 37	265

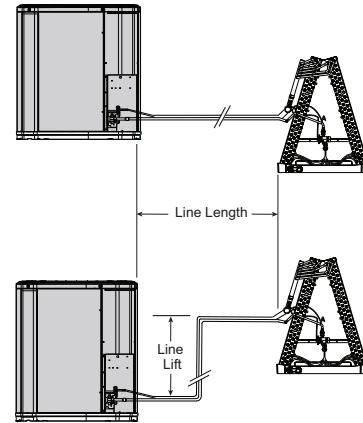
\* Weight values are estimated (uncrated).

- When mounting the outdoor unit on a roof, be sure the roof will support the unit's weight.
- Properly selected isolation is recommended to alleviate sound or vibration transmission to the building structure.

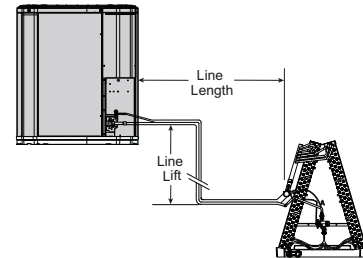


**Table 3. Refrigerant Line and Service Valve Connection Sizes**

Model	Rated Line Sizes		Service Valve Connection Sizes	
	Vapor Line	Liquid Line	Vapor Line Connection	Liquid Line Connection
5TWV0X24A	1/2 (a), (b)	5/16	1/2	5/16
5TWV0X36A	5/8 (a), (b)	5/16	5/8	5/16
5TWV0X48A	3/4 (a), (b)	5/16	7/8	5/16
5TWV0X60A	3/4 (a), (b)	5/16	3/4	5/16
5TTV0X24A	1/2 (a), (b)	5/16	1/2	5/16
5TTV0X25A	1/2 (a), (b)	5/16	1/2	5/16
5TTV0X36A	5/8 (a), (b)	5/16	5/8	5/16
5TTV0X48A	3/4 (a), (b)	5/16	7/8	5/16
5TTV0X60A	3/4 (a), (b)	5/16	7/8	5/16



Refer to (a), (b), and (c) footnotes for specific model details



(a) For max length of refrigerant lines from outdoor to indoor unit refer Table 4.  
 (b) Select correct line set size in set up app. Default is set to alternate line sizes.

**Table 4. Lineset sizes and length**

X24 and X25 Models			
Vapor Line	Liquid Line	Length	Vertical Change
1/2	5/16	200	50
5/8	5/16	200	50
1/2	3/8	200	50
5/8	3/8	200	50
<b>Note:</b>			
Ratings/Primary			
Legacy			

Diameter	X24 and X25 Models AC (HP) Subcooling Adders						
	Liquid	ft	10	20	30	40	50
5/16	50						0
	40					0	0
	30				0	0	0
	20			0	0	0	0
	10	0	0	0	0	0	0
	0	0	0	0	0	0	0

**Note:** \*No Subcooling Adders needed. Use 0 for everything.

**Table 5. Lineset sizes and length**

X36 Models			
Vapor Line	Liquid Line	Length	Vertical Change
1/2	5/16	80	50
5/8	5/16	200	50
3/4	5/16	200	50
1/2	3/8	80	50
5/8	3/8	200	50
3/4	3/8	200	50
<b>Note:</b>			
Ratings/Primary			
Legacy			
Smallest Allowed			

Diameter	X36 Models AC (HP) Subcooling Adders																						
	Liquid	ft	10	20	30	40	50	60	70	80	90	100	110	120	130	140	150	160	170	180	190	200	
5/16	50					0	0	0	0	1	1	2	2	2	2	3	3	3	4	4	4		
	40				0	0	0	0	0	0	0	1	0	1	1	2	2	2	3	3	3		
	30			0	0	0	0	0	0	0	0	0	0	0	1	1	1	1	2	2	2		
	20		0	0	0	0	0	0	0	0	0	0	0	0	0	0	0	0	0	1	1	1	
	10	0	0	0	0	0	0	0	0	0	0	0	0	0	0	0	0	0	0	0	0	0	0
	0	0	0	0	0	0	0	0	0	0	0	0	0	0	0	0	0	0	0	0	0	0	0

**Note:** \*No Subcooling Adders required for 3/8" linesets.



## Unit Location Considerations

**Table 6. Lineset sizes and length**

X48 Models			
Vapor Line	Liquid Line	Length	Vertical Change
5/8	5/16	100	25
3/4	5/16	100	25
7/8	5/16	100	25
5/8	3/8	100	50
3/4	3/8	200	50
7/8	3/8	150	10
<b>Note:</b>			
Ratings/Primary			
Intermediate			
Smallest Allowed			

Diameter	X48 Models AC (HP) Subcooling Adders										
Liquid	ft	10	20	30	40	50	60	70	80	90	100
5/16	50										
	40										
	25			0	0	1	1	2	3	4	4
	20		0	0	0	0	1	2	2	3	4
	10	0	0	0	0	0	0	1	1	2	3
	0	0	0	0	0	0	0	0	1	1	2

**Note:** \*No Subcooling Adders required for 3/8" linesets.

**Table 7. Lineset sizes and length**

X60 Models (HP only)			
Vapor Line	Liquid Line	Length	Vertical Change
5/8	5/16	70	25
3/4	5/16	70	25
7/8	5/16	70	25
5/8	3/8	80	50
3/4	3/8	150	50
7/8	3/8	200	50
<b>Note:</b>			
Ratings/Primary			
Legacy			
Smallest Allowed			

X60 Models (AC only)			
Vapor Line	Liquid Line	Length	Vertical Change
5/8	5/16	70	25
3/4	5/16	70	25
7/8	5/16	70	25
5/8	3/8	80	50
3/4	3/8	200	50
7/8	3/8	200	10
<b>Note:</b>			
Ratings/Primary			
Legacy			
Smallest Allowed			



## Unit Location Considerations

Diameter	X60 Models HP Subcooling Adders							
Liquid	ft	10	20	30	40	50	60	70
5/16	25			0	1	2	4	4
	20		0	0	0	1	3	4
	10	0	0	0	0	1	2	3
	0	0	0	0	0	0	1	2

Diameter	X60 Models AC Subcooling Adders																				
Liquid	ft	10	20	30	40	50	60	70	80	90	100	110	120	130	140	150	160	170	180	190	200
3/8	50					0	0	0	0	0	0	1	1	1	1	2	2	2	2	2	3
	40				0	0	0	0	0	0	0	0	0	0	0	1	1	1	1	1	2
	30			0	0	0	0	0	0	0	0	0	0	0	0	0	0	0	0	0	1
	20		0	0	0	0	0	0	0	0	0	0	0	0	0	0	0	0	0	0	0
	10	0	0	0	0	0	0	0	0	0	0	0	0	0	0	0	0	0	0	0	0
	0	0	0	0	0	0	0	0	0	0	0	0	0	0	0	0	0	0	0	0	0

**Table 8. Alternate Refrigerant Line and Service Valve Connection Sizes**

Model	Alternate Line Sizes		Service Valve Connection Sizes	
	Vapor Line	Liquid Line	Vapor Line Connection	Liquid Line Connection
5TWV0X24A	5/8" (a), (b)	3/8"	1/2"	5/16"
5TWV0X36A	3/4" (a), (b)	3/8"	5/8"	5/16"
5TWV0X48A	3/4" (a), (b)	3/8"	7/8"	5/16"
5TWV0X60A	7/8" (a), (b)	3/8"	3/4"	5/16"
Model	Alternate Line Sizes		Service Valve Connection Sizes	
	Vapor Line	Liquid Line	Vapor Line Connection	Liquid Line Connection
5TTV0X24A	5/8" (a), (b)	3/8"	1/2"	5/16"
5TTV0X25A	5/8" (a), (b)	3/8"	1/2"	5/16"
5TTV0X36A	3/4" (a), (b)	3/8"	5/8"	5/16"
5TTV0X48A	3/4" (a), (b)	3/8"	7/8"	5/16"
5TTV0X60A	7/8" (a), (b)	3/8"	7/8"	5/16"

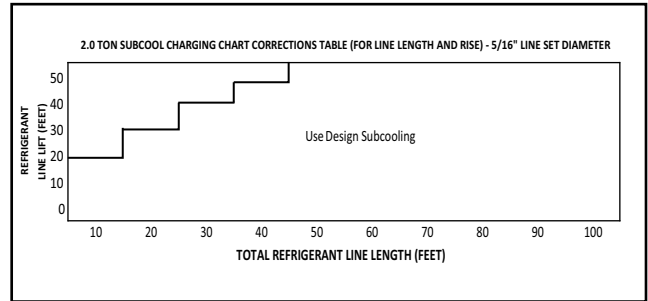
(a) For max length of refrigerant lines from outdoor to indoor unit refer Table 4.  
 (b) Select correct line set size in set up app. Default is set to alternate line sizes.



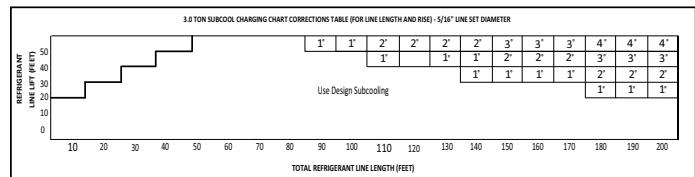
# Subcool Charging Correction Charts

**Note:** System will auto configure airflow in Link mode.  
**Note:** For 2, 3 and 4T systems with 3/8" line set diameters, use design subcooling for all length and lift combinations.

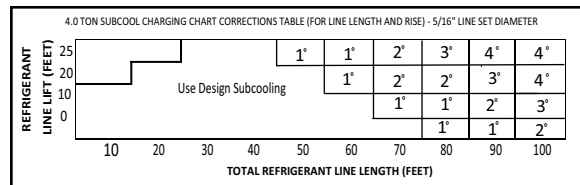
**Figure 1. Subcool Charging Corrections – X24 and X25 Models**



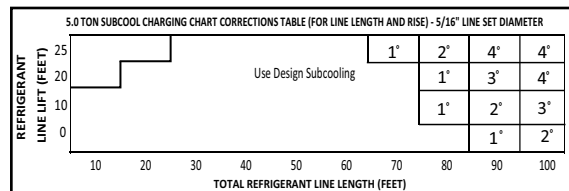
**Figure 2. Subcool Charging Corrections – X36 Models**



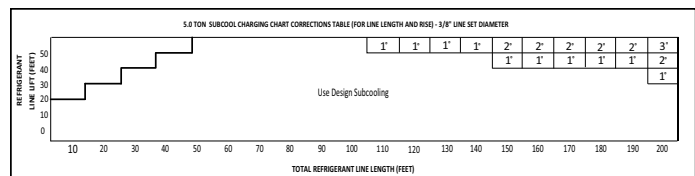
**Figure 3. Subcool Charging Corrections – X48 Models**



**Figure 4. Subcool Charging Corrections – X60 Models (5/16)**



**Figure 5. Subcool Charging Corrections – X60 Models (3/8)**



## R-454B Refrigerant Charging Chart

LIQUID TEMP (F)	DESIGN SUBCOOLING (F)						
	8	9	10	11	12	13	14
	LIQUID GAGE PRESSURE (PSIG)						
55	170	172	175	178	181	184	187
60	184	187	190	194	197	200	203
65	200	203	206	210	213	217	220
70	217	220	223	227	230	234	238
75	234	238	241	245	249	252	256
80	252	256	260	264	268	272	276
85	272	276	280	284	288	292	297
90	292	297	301	305	309	314	318
95	314	318	323	327	332	336	341
100	336	341	346	351	355	360	365
105	360	365	370	375	380	385	390
110	385	390	396	401	406	412	417
115	412	417	422	428	433	439	445
120	439	445	450	456	462	468	474
125	468	474	480	486	492	498	504

Note: When charging to Subcooling values, use Bubble Temp chart. If referencing Superheat, use Dew Point chart.

## Refrigerant Properties

Table 9. Refrigerant Properties

Pgauge (psig)	Superheat Dew Table (°F)	Subcooling Bubble Table (°F)
30	-12	-14
35	-7	-9
40	-2	-4
45	2	0
50	6	4
55	10	7
60	13	11
65	17	14
70	20	18
75	23	21
80	26	24
85	29	26
90	31	29
95	34	32
100	37	34
105	39	37
110	41	39
115	44	41
120	46	44
125	48	46
130	50	48
135	52	50
140	54	52

Table 9. Refrigerant Properties (continued)

Pgauge (psig)	Superheat Dew Table (°F)	Subcooling Bubble Table (°F)
145	56	54
150	58	56
155	60	58
160	62	60
165	64	61
170	66	63
175	67	65
180	69	67
185	71	68
190	72	70
195	74	71
200	75	73
205	77	75
210	78	76
215	80	78
220	81	79
225	83	80
230	84	82
235	86	83
240	87	85
245	88	86
250	90	87
255	91	89
260	92	90



## Unit Location Considerations

**Table 9. Refrigerant Properties (continued)**

Pgauge (psig)	Superheat Dew Table (°F)	Subcooling Bubble Table (°F)
265	94	91
270	95	93
275	96	94
280	97	95
285	99	96
290	100	97
295	101	99
300	102	100
305	103	101
310	104	102
315	106	103
320	107	104
325	108	105
330	109	107
335	110	108
340	111	109
345	112	110
350	113	111
355	114	112
360	115	113
365	116	114
370	117	115
375	118	116
380	119	117
385	120	118
390	121	119
395	122	120
400	123	121
405	124	122

**Table 9. Refrigerant Properties (continued)**

Pgauge (psig)	Superheat Dew Table (°F)	Subcooling Bubble Table (°F)
410	125	123
415	126	124
420	127	125
425	128	125
430	128	126
435	129	127
440	130	128
445	131	129
450	132	130
455	133	131
460	134	132
465	134	132
470	135	133
475	136	134
480	137	135
485	138	136
490	139	137
495	139	137
500	140	138
505	141	139
510	142	140
515	143	141
520	143	141
525	144	142
530	145	143
535	146	144
540	146	145
545	147	145
550	148	146

## Suggested Locations

**Table 10. Suggested Locations for Best Reliability**

<ul style="list-style-type: none"> <li>• Ensure the top discharge area is unrestricted for at least 5 feet above the unit.</li> <li>• Provide at least 3 feet clearance in front of the control box (access panels) and any other side requiring service.</li> <li>• Do not locate close to bedrooms as operational sounds may be objectionable.</li> <li>• Avoid locations near windows and similar areas where condensation and freezing defrost vapor can annoy a customer.</li> <li>• Position the outdoor unit a minimum of 12" from any wall or surrounding shrubbery to ensure adequate airflow.</li> <li>• Outdoor unit location must be far enough away from any structure to prevent excess roof runoff water or icicles from falling directly on the unit.</li> </ul>	<p>The diagram illustrates the required clearances for the outdoor unit. A vertical dimension line indicates a minimum of 5 feet of unrestricted space above the unit. A horizontal dimension line shows a minimum of 3 feet of unrestricted space in front of the unit, specifically in front of the access panel. A vertical dimension line on the left shows a minimum of 12 inches of clearance from any wall or shrubbery. A circular icon with a diagonal line through it and the text 'Avoid Install Near Bedrooms' is shown above the unit. The unit is shown with an 'Access Panel' label.</p>
<ul style="list-style-type: none"> <li>• Position the outdoor unit a minimum of 12" from any wall or surrounding shrubbery to ensure adequate airflow.</li> <li>• Outdoor unit location must be far enough away from any structure to prevent excess roof runoff water or icicles from falling directly on the unit.</li> </ul>	<p>This diagram shows the unit's placement relative to a wall and shrubbery. A vertical dimension line on the left indicates a minimum of 12 inches of clearance from any wall or shrubbery. A horizontal dimension line on the right indicates a minimum of 12 inches of clearance from any wall. A circular icon with a diagonal line through it and raindrops falling from it is positioned above the unit, indicating that roof runoff water or icicles should not fall directly on the unit.</p>

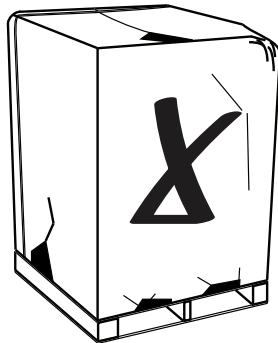
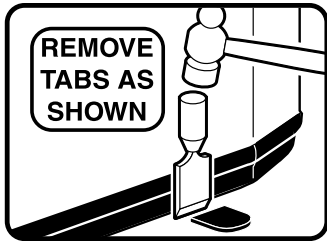
**Table 11. Cold Climate Considerations (Heat Pump Only)**

<p><b>Note:</b> It is recommended that these precautions be taken for units being installed in areas where snow accumulation and prolonged below-freezing temperatures occur.</p> <ul style="list-style-type: none"> <li>• Units should be elevated 3–12 inches above the pad or rooftop, depending on local weather. This additional height will allow drainage of snow and ice melted during defrost cycle prior to its refreezing. Ensure that drain holes in unit base pan are not obstructed, preventing drainage of defrost water.</li> <li>• If possible, avoid locations that are likely to accumulate snow drifts. If not possible, a snow drift barrier should be installed around the unit to prevent a build-up of snow on the sides of the unit.</li> </ul>	<p>The diagram shows the unit installed on a 'Pad'. The unit is elevated on 'Snow Legs' to a height of '3-12" Elevation' above the pad. A 'Snow Barrier' is shown on the left side of the unit. Snowflakes are depicted falling around the unit. A vertical dimension line on the left indicates a minimum of 12 inches of clearance from any wall or shrubbery.</p>
--	--

## Coastal Considerations

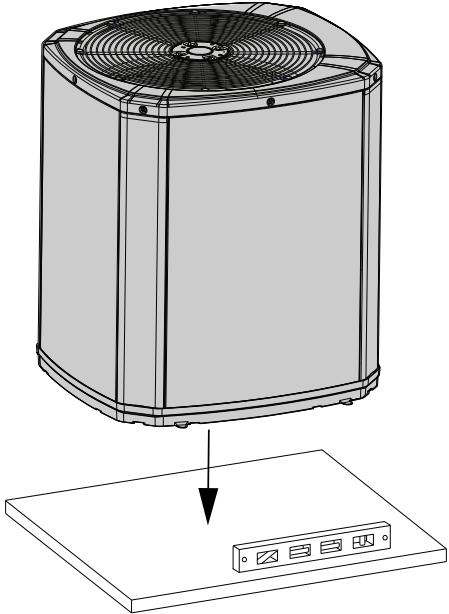
If installed within one mile of salt water, including seacoasts and inland waterways, models without factory supplied Seacoast Salt Shields require the addition of BAYSEAC001 (Seacoast Kit) at installation time.

## Unit Preparation

<p>1. Check for damage and report promptly to the carrier any damage found to the unit.</p>	
<p>2. To remove the unit from the pallet, remove tabs by cutting with a sharp tool.</p>	

## Setting Up the Unit

**Table 12. Pad Installation**

<p>When installing the unit on a support pad, such as a concrete slab, consider the following:</p> <ul style="list-style-type: none"> <li>• The pad should be at least 1" larger than the unit on all sides.</li> <li>• The pad must be separate from any structure.</li> <li>• The pad must be level.</li> <li>• The pad should be high enough above grade to allow for drainage.</li> <li>• The pad location must comply with National, State, and Local codes.</li> </ul>	
--	--

# Refrigerant Line Considerations

**Table 13. Factory Charge**

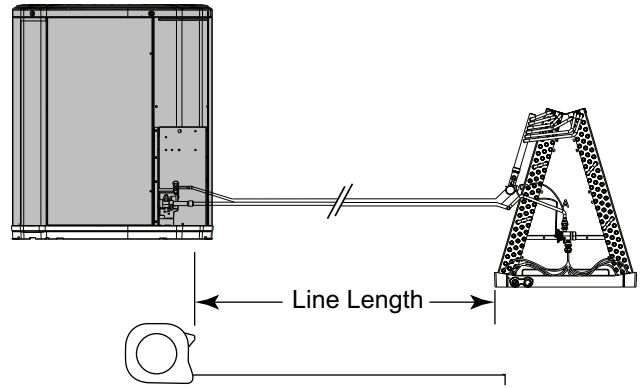
The outdoor condensing units are factory charged with the system charge required for the outdoor condensing unit, ten (10) feet of tested connecting line, and the smallest rated indoor evaporative coil match. Always verify proper system charge via subcooling (TXV/EEV).

**Table 14. Required Refrigerant Line Length**

Determine required line length and lift. You will need this to determine the subcooling charging corrections later in the installation process.

Total Line Length = \_\_\_\_\_ Ft.

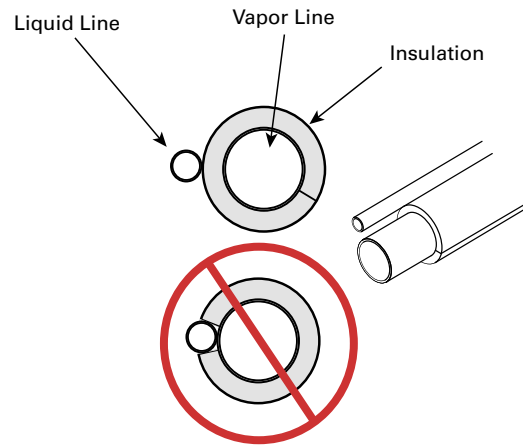
Total Vertical Change (lift) = \_\_\_\_\_ Ft.



**Table 15. Refrigerant Line Insulation**

**Important:** The Vapor Line must always be insulated. DO NOT allow the Liquid Line and Vapor Line to come in direct (metal to metal) contact.

**Note:** The Vapor Line must always be insulated. Insulating the liquid line through attic spaces may benefit system performance by minimizing heat gain in the liquid line.



## Refrigerant Line Considerations

**Table 16. Reuse Existing Refrigerant Lines**

<div style="background-color: black; color: white; padding: 5px; text-align: center; font-weight: bold; font-size: 1.2em;">             ⚠ CAUTION         </div> <div style="border: 1px solid black; padding: 5px; margin-top: 5px;"> <p><b>REFRIGERANT!</b>              Failure to inspect or use proper service tools may result in equipment damage or personal injury. If using existing refrigerant lines make certain that all joints are brazed, not soldered.</p> </div> <p>For retrofit applications, where the existing indoor evaporator coil and/or refrigerant lines will be used, the following precautions should be taken.</p> <ul style="list-style-type: none"> <li>• Ensure that the indoor evaporator coil and refrigerant lines are the correct size.</li> <li>• Ensure that the refrigerant lines are free of leaks, acid, and oil.</li> </ul> <p><b>Important:</b> For more information, see publication number SS-APG006-EN</p>	
---	--

**Table 17. Refrigerant Line Routing Precautions**

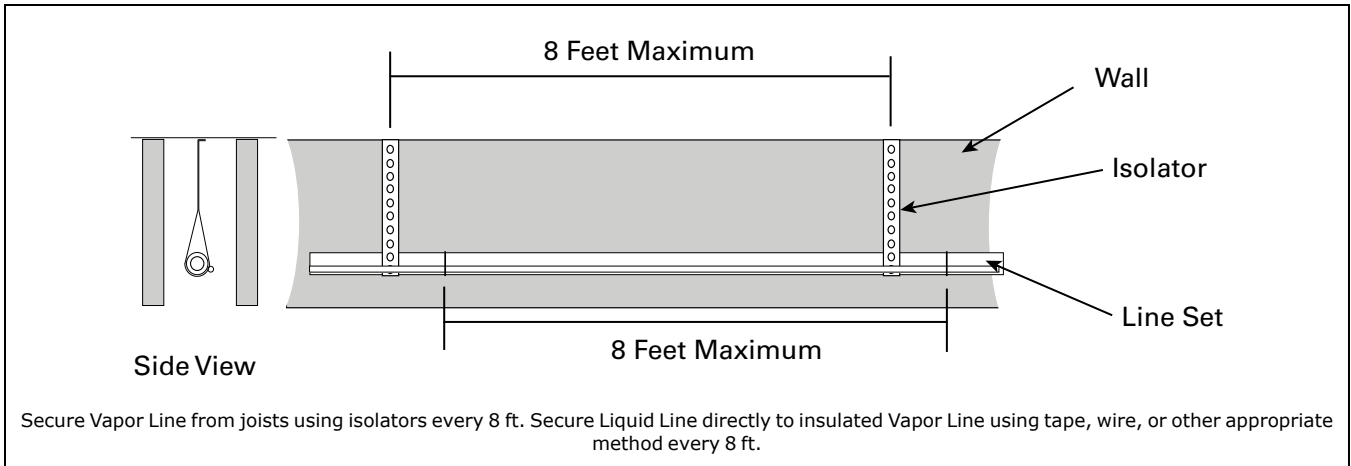
<p><b>Important:</b> Comply with National, State, and Local Codes when isolating line sets from joists, rafters, walls, or other structural elements.</p> <p><b>Important:</b> For buried linesets, see publication number SS-APG006-EN.</p> <p><b>Important:</b> Take precautions to prevent noise within the building structure due to vibration transmission from the refrigerant lines.</p> <p>For Example:</p> <ul style="list-style-type: none"> <li>• When the refrigerant lines must be fastened to floor joists or other framing in a structure, use isolation type hangers.</li> <li>• Isolation hangers should also be used when refrigerant lines are run in stud spaces or enclosed ceilings.</li> <li>• Where the refrigerant lines run through a wall, sill or enclosed ceiling- they should be insulated, isolated and serviceable if any braze connections are present.</li> <li>• Isolate the lines from all duct work.</li> <li>• Minimize the number of 90° turns.</li> </ul>
---

**Table 18. Isolation From Joist/Rafter**

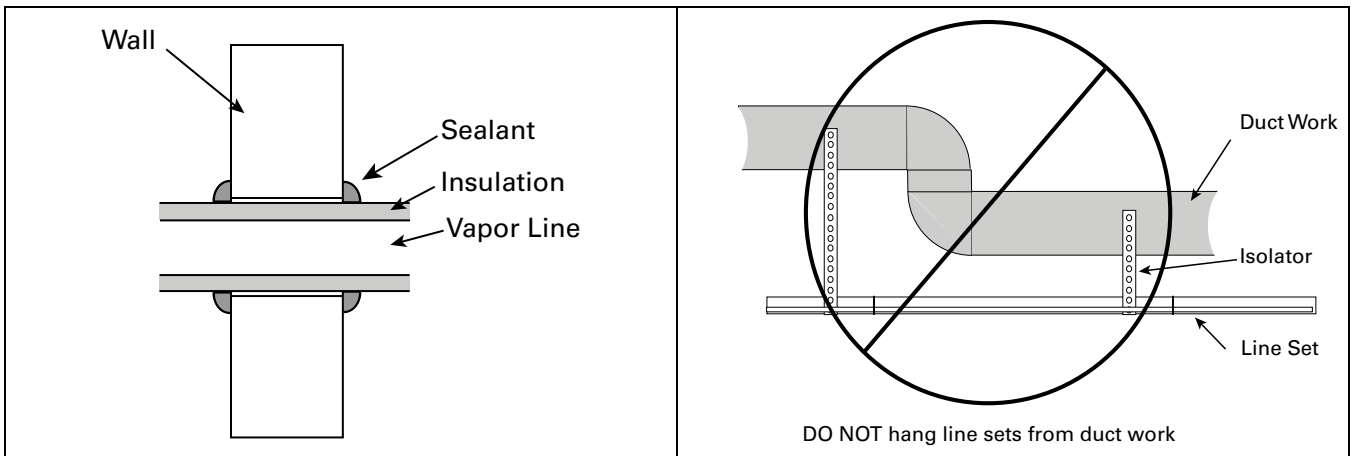
<p>Secure Vapor Line from joists using isolators every 8 ft. Secure Liquid Line directly to insulated Vapor Line using tape, wire, or other appropriate method every 8 ft.</p>



**Table 19. Isolation In Wall Spaces**

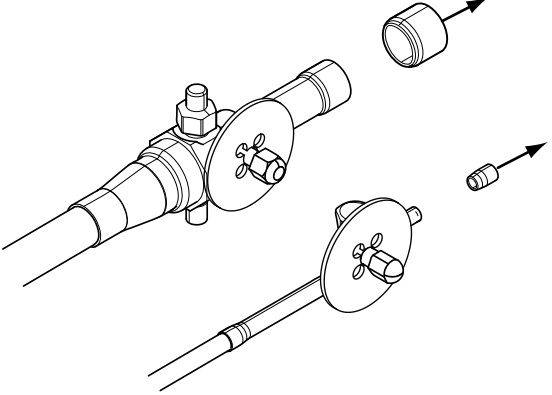
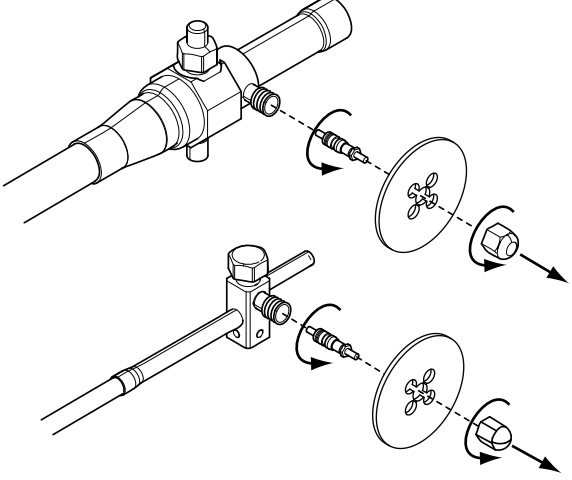
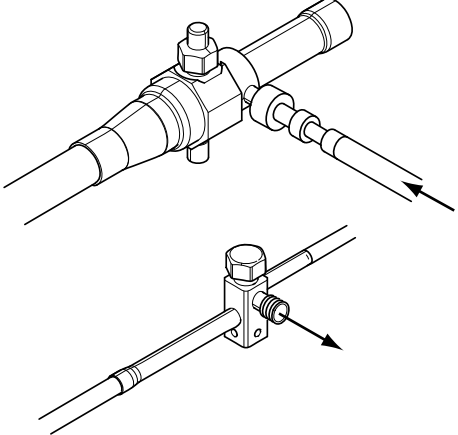


**Table 20. Isolation Through Wall**



# Refrigerant Line Brazing

**Table 21. Braze the Refrigerant Lines**

<p>1. Remove caps or plugs. Use a deburring tool to deburr the pipe ends. Clean both internal and external surfaces of the tubing using an emery cloth.</p>	
<p>2. Remove the pressure tap cap, plastic tab and valve core from each service valves.</p>	
<p>3. Purge the refrigerant lines and indoor coil with dry nitrogen.  <b>Note:</b> A2L equipment shall have red marked service ports and pipes through which refrigerant is serviced.</p>	

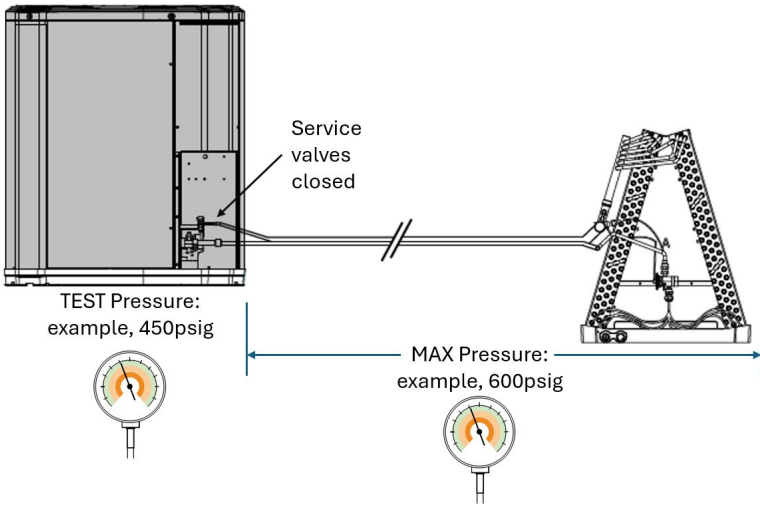
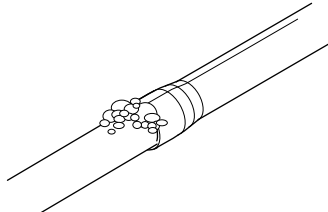
**Table 21. Braze the Refrigerant Lines (continued)**

<p>4. Wrap a wet rag around the valve body to avoid heat damage and continue the dry nitrogen purge.</p> <p>5. Braze the refrigerant lines to the service valves.</p> <p>a. For Units shipped with a field-installed external drier, check liquid line filter drier's directional flow arrow to confirm correct direction of refrigeration flow (away from outdoor unit and toward evaporator coil) as illustrated. Braze the filter drier to the Liquid Line.</p> <p>6. Continue the dry nitrogen purge. Do not remove the wet rag until all brazing is completed.</p> <p><b>Important:</b> Remove the wet rag before stopping the dry nitrogen purge.</p> <p><b>Note:</b> Precautions should be taken to avoid heat damage to base pan during brazing. It is recommended to keep the flame directly off of the base pan.</p>	
<p>7. Replace the pressure tap valve cores and plastic tabs after the service valves have cooled.</p>	

# Refrigerant Line Leak Check

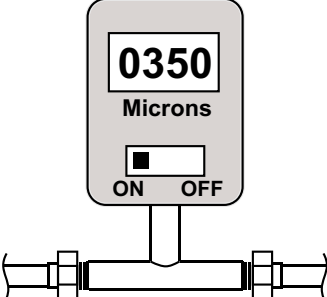

**Table 22. Check for Leaks**

**Important:** The outdoor unit should not be tested higher than 450 PSIG for servicing or component replacement. The indoor unit and linesets should be tested to the max pressure specified on the outdoor or indoor unit nameplate. The service valves should be closed when pressure testing the indoor unit and linesets to separate the outdoor unit from the indoor unit.

<p>1. Final Pressure Check - Isolate the outdoor unit from the indoor unit and linesets using the service valves. Pressurize the indoor unit and linesets to the max pressure specified on the outdoor or indoor unit nameplate for a minimum of 60 minutes. Do not add additional refrigerant or test gas after reaching the indoor unit specified pressure. The system should show no loss of pressure once pressurized. Once the pressure test is complete follow the steps for evacuation.</p> <p><b>*OPTIONAL (Preliminary Pressure Check) -</b> Pressurize the indoor unit and linesets to 150 PSIG using dry nitrogen.</p>	
<p>2. Check for leaks by using a soapy solution at each brazed location.</p> <p><b>Note:</b> Remove nitrogen pressure and repair any leaks before continuing.</p>	

Nitrogen Purge Times				
Flow Rate	Lineset Length			
CuFt/Hr	< 50 feet	< 100 feet	< 150 feet	< 200 feet
<b>15</b>	2 Minutes	4 Minutes	6 Minutes	8 Minutes
<b>30</b>	1 Minute	2 Minutes	3 Minutes	4 Minutes
<b>60</b>	1 Minute	1 Minute	2 Minutes	2 Minutes

## Refrigerant Line and Indoor Coil Evacuation

<p><b>Important:</b> Do not open the service valves until the refrigerant lines and indoor coil leak check and evacuation are complete.</p> <ol style="list-style-type: none"> <li>1. Evacuate until the micron gauge reads no higher than 350 microns, then close off the valve to the vacuum pump.</li> </ol>	
<ol style="list-style-type: none"> <li>2. Observe the micron gauge. Evacuation is complete if the micron gauge does not rise above 1500 microns in ten (10) minute.</li> <li>3. When evacuation is complete, blank off the vacuum pump and micron gauge, and close the valves on the manifold gauge set.</li> </ol>	
<p>Under no circumstances shall potential sources of ignition be used in the searching for or detection of refrigerant leaks. The following leak detection methods are deemed acceptable for all refrigerant systems:</p> <ul style="list-style-type: none"> <li>• Electronic leak detectors calibrated for R454B</li> <li>• Bubble method</li> </ul> <p>If a leakage of refrigerant is found which requires brazing, all of the refrigerant shall be recovered from the system, or isolated (by means of shut off valves) in a part of the system remote from the leak.</p>	



# Refrigerant Line Leak Check

## Servicing

### When Servicing:

- The area shall be checked with an appropriate refrigerant detector prior to and during work, to ensure the technician is aware of potentially toxic or flammable atmospheres.
- Ensure that the leak detection equipment being used is suitable for use with all applicable refrigerants, i.e. non-sparking, adequately sealed or intrinsically safe.
- Work shall be undertaken under a controlled procedure so as to minimise the risk of a flammable gas or vapor being present while the work is being performed.
- If any hot work is to be conducted on the refrigerating equipment or any associated parts, appropriate fire extinguishing equipment shall be available to hand.
- Have a dry powder or CO2 fire extinguisher adjacent to the servicing area.
- Ensure that the area is in the open or that it is adequately ventilated before breaking into the system or conducting any hot work.
- A degree of ventilation shall continue during the period that the work is carried out. The ventilation should safely disperse any released refrigerant and preferably expel it externally into the atmosphere.

**Important:** The following leak detection methods are deemed acceptable for all refrigerant systems:

1. Electronic leak detectors calibrated for R454B
2. Bubble method

**Important:** Under no circumstances shall potential sources of ignition be used in the searching for or detection of refrigerant leaks.

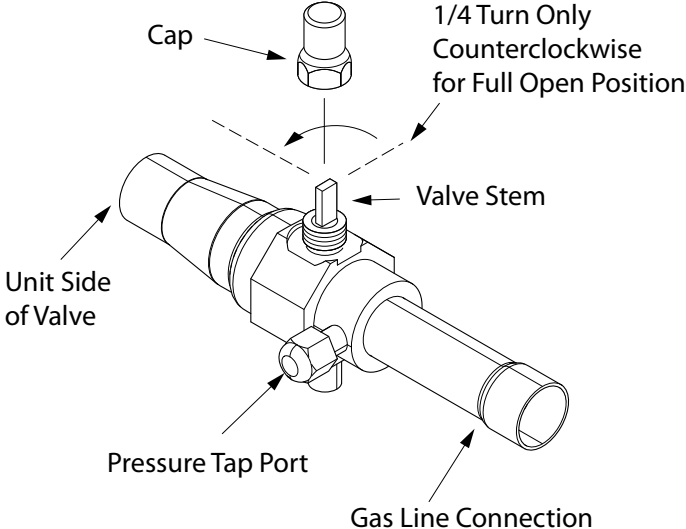
- If a leak is suspected, all naked flames shall be removed/extinguished.
- If a leakage of refrigerant is found which requires brazing, all of the refrigerant shall be recovered from the system, or isolated (by means of shut off valves) in a part of the system remote from the leak.
- If repairs must be made after system is charged, properly and safely remove or isolate refrigerant and purge the section of the system needing repair with inert gas or oxygen free nitrogen prior to opening the circuit.
- The REFRIGERANT CHARGE shall be recovered into the correctly marked recovery cylinders. Ensure that the outlet for the vacuum pump is not close to any potential ignition sources and that ventilation is available."
- Nitrogen purge chart:

Nitrogen Purge Times				
Flow Rate	Lineset Length			
CuFT/Hr	< 50 feet	< 100 feet	< 150 feet	< 200 feet
15	2 Minutes	4 Minutes	6 Minutes	8 Minutes
30	1 Minute	2 Minutes	3 Minutes	4 Minutes
60	1 Minute	1 Minute	2 Minutes	2 Minutes

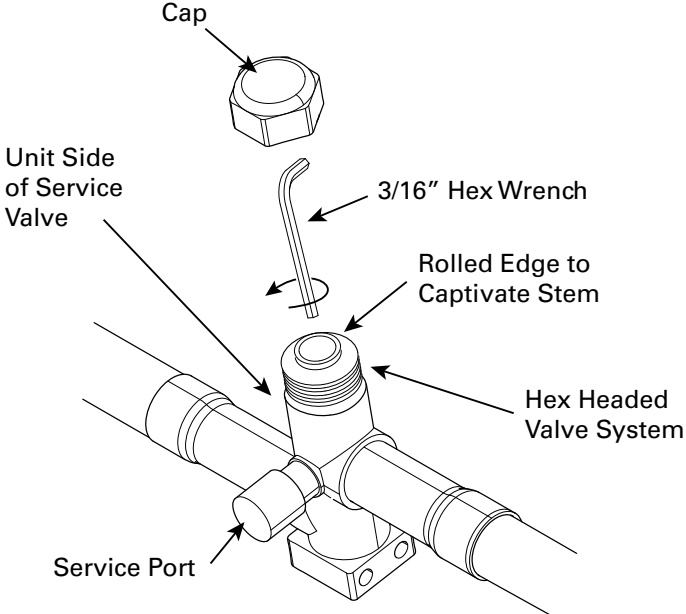
- Ensure that only appropriate refrigerant recovery cylinders are employed. Ensure that the correct number of cylinders for holding the total system charge is available. Only use cylinders designated for the recovered refrigerant and labelled for that refrigerant. Cylinders shall be complete with pressure-relief valve and associated shut-off valves in good working order.
- A calibrated weighing scale shall be available and in good working order. Hoses shall be complete with leak-free disconnect couplings and in good condition. Ensure any associated electrical components are sealed.
- The recovered refrigerant shall be returned to the refrigerant supplier in the correct recovery cylinder. Do not mix refrigerants.
- If compressors or compressor oils are to be removed, ensure that they have been evacuated to an acceptable level to make certain that FLAMMABLE REFRIGERANT does not remain within the lubricant.

# Service Valves

**Table 23. Open the Gas / Vapor Service Valve First**

<p><b>Important:</b> Leak check and evacuation must be completed before opening the service valves.</p> <p><b>Note:</b> Do not vent refrigerant gases into the atmosphere.</p> <ol style="list-style-type: none"> <li>1. Remove valve stem cap.</li> <li>2. Using a wrench, turn valve stem 1/4 turn counterclockwise to the fully open position.</li> <li>3. Replace the valve stem cap to prevent leaks. Tighten finger tight plus an additional 1/4 turn.</li> </ol> <p><b>Note:</b> Valve caps need to be brass or locking style.</p> <p><b>Note:</b> Opening the Vapor service valve first ensures the compressor oil stays in the compressor at start up.</p>	
---	--

**Table 24. Open the Liquid Service Valve**

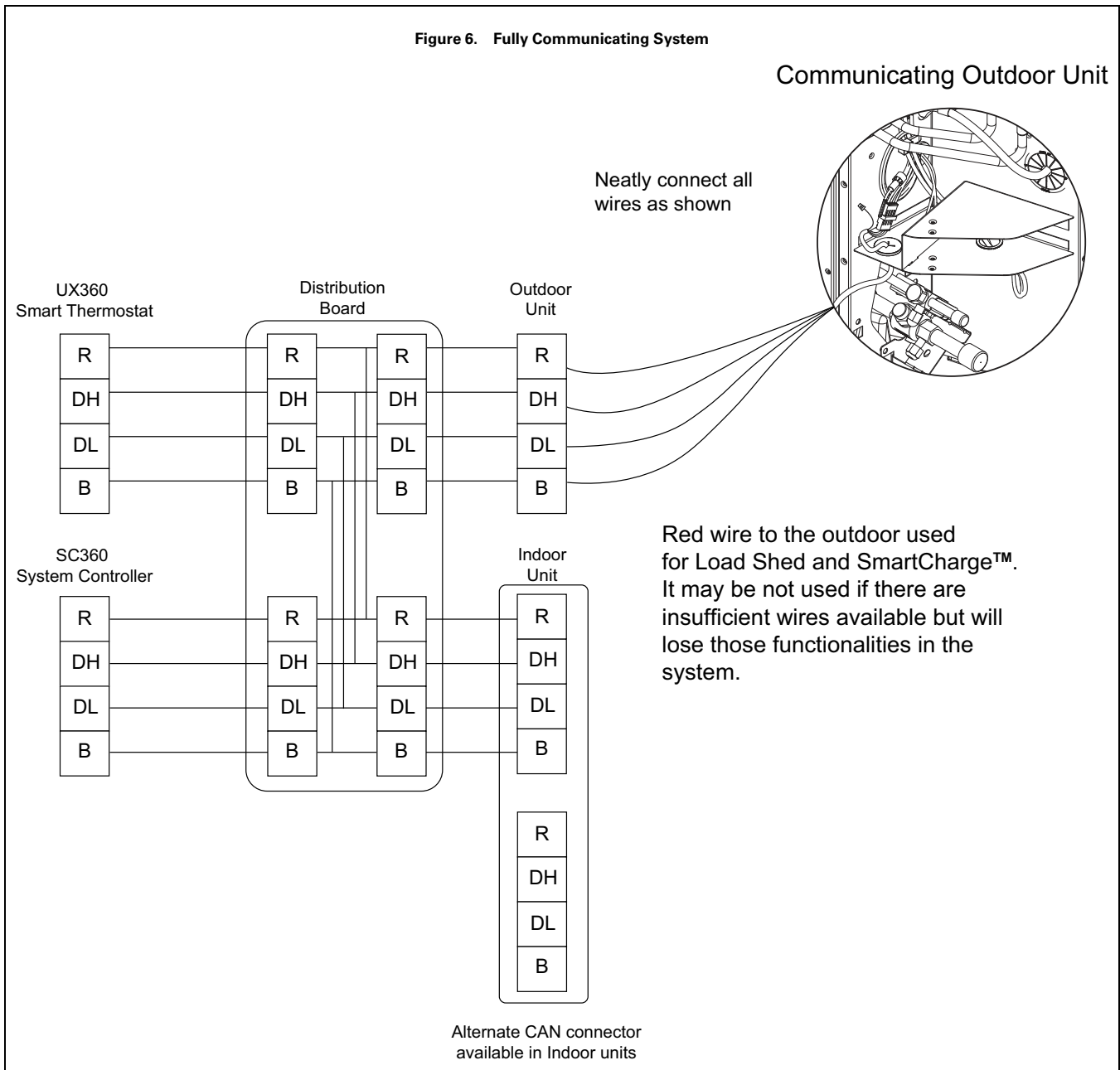
<div style="background-color: black; color: white; padding: 5px; text-align: center;"> <p><b>⚠ WARNING</b></p> <p><b>SERVICE VALVES!</b></p> <p>Failure to follow this warning will result in abrupt release of system charge and may result in personal injury and/or property damage. Extreme caution should be exercised when opening the Suction and Liquid Line Service Valve. Turn valve stem counterclockwise only until the stem contacts the rolled edge. No torque is required.</p> </div> <p><b>Important:</b> Leak check and evacuation must be completed before opening the service valves.</p> <ol style="list-style-type: none"> <li>4. Remove service valve cap.</li> <li>5. Fully insert 3/16" hex wrench into the stem and back out counterclockwise until valve stem just touches the rolled edge (approximately five (5) turns).</li> <li>6. Replace the valve cap to prevent leaks. Tighten finger tight plus an additional 1/4 turn.</li> </ol>	
---	---

# Electrical – Low Voltage Communicating

**Table 25. Low Voltage Maximum Wire Length**

<p>This table defines the size and combined total maximum length of low voltage wiring from the outdoor unit, to the indoor unit, and to the thermostat.</p> <p><b>Note:</b> The use of color coded low voltage wire is recommended to simplify connections between the outdoor unit, the control, and the indoor unit.</p> <p><b>Note:</b> The maximum total cable length for the entire comfort control communicating system is 500 ft. 18 AWG.</p>	CONTROL WIRING	
	WIRE SIZE	MAX. WIRE LENGTH
	18 AWG	500 Ft. Combined

**Table 26. Low Voltage Hook-up Diagrams in Link mode**





**Table 27. Link Low Voltage Wire Connectors**

Link mode uses simple connectors for low voltage connections. These connections are color coded which makes the installation easier and quicker.

Link Wire Colors	
R	Red
DH	White
DL	Green
B	Blue

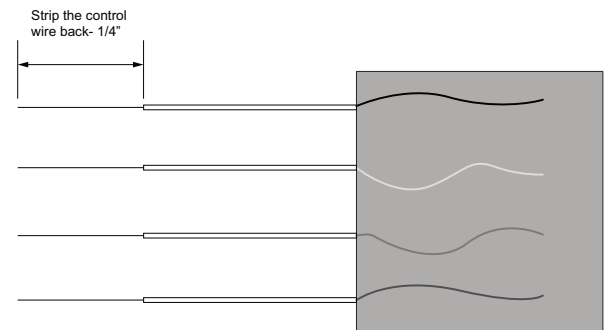
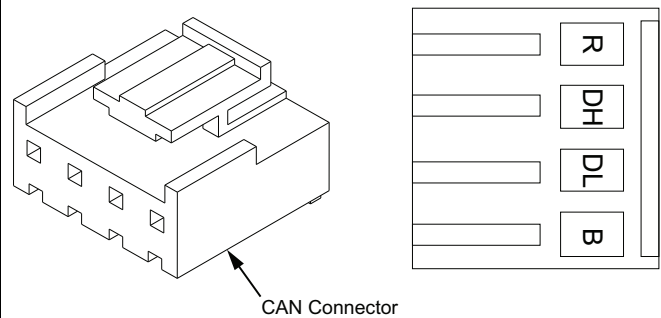
Do the following to make the connections from the actual thermostat wire to the connector.

**Note:** These connectors are necessary for the Outdoor unit, Indoor unit and Distribution board.

- Strip the Red, White, Green and Blue thermostat wires back 1/4".
- Insert the wires into the connector in the correctly colored locations.
- When you feel it release, allow each wire to slide in further.**
- Pull back on the wires individually and slightly and check if the wires are seated properly. If each wire does not pull out for all four wires, the connection is complete.
- Connectors are ONE TIME USE. If a 18 ga. Thermostat wire gets broken off inside of the connector, the connector will need replaced.
- Wire colors are for illustration purposes only. If using a different color, ensure it lands at the correct terminal throughout all of the communicating control wiring.

Connect the CAN connector into the male coupling on the low voltage harness at the Outdoor unit.

This indoor unit has two dedicated CAN Connector headers on the Indoor Unit Control Board. In Link communicating mode, both of them are in the communicating loop. It does not matter which one goes to the thermostat, System Controller, distribution board, outdoor unit or any other Link accessory.



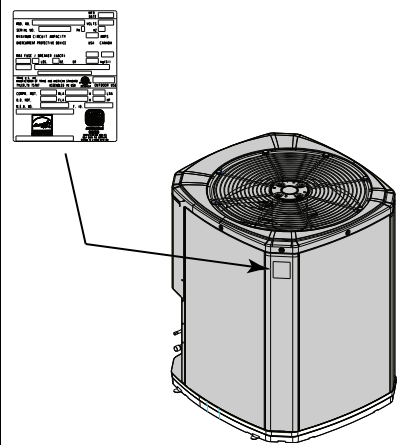
**Note:** For use with 18 ga. solid core thermostat wire.

## Refrigerant Detection System Guidelines

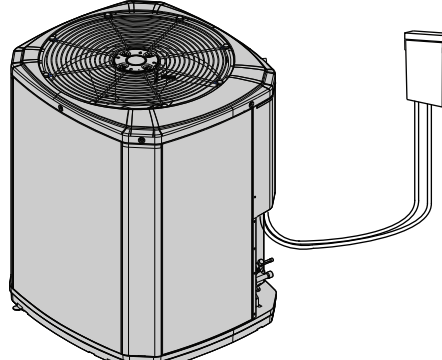
- The approved ID/OD combination will provide sufficient safe ventilation in case of a leak.
- Refer Indoor Unit Installer's Guide for correct specifications on indoor unit install.
- All systems require Refrigerant Detection Systems.
- RDS (Refrigerant Detection System) included in an A2L System.

# Electrical – High Voltage

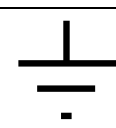
**Table 28. High Voltage Power Supply**

<div style="background-color: black; color: white; padding: 5px; text-align: center;"><b>⚠ WARNING</b></div> <p><b>LIVE ELECTRICAL COMPONENTS!</b>          Failure to follow this Warning could result in property damage, severe personal injury, or death. Follow all electrical safety precautions when exposed to live electrical components. It may be necessary to work with live electrical components during installation, testing, servicing, and troubleshooting of this product.</p> <p>The high voltage power supply must agree with the equipment nameplate.</p> <p>Power wiring must comply with national, state, and local codes.</p> <p>Follow instructions on unit wiring diagram located on the inside of the control box cover and in the Service Facts document included with the unit.</p>	 <p>The diagram shows a wiring schematic with labels for 'U1', 'U2', 'U3', 'U4', 'U5', 'U6', 'U7', 'U8', 'U9', 'U10', 'U11', 'U12', 'U13', 'U14', 'U15', 'U16', 'U17', 'U18', 'U19', 'U20', 'U21', 'U22', 'U23', 'U24', 'U25', 'U26', 'U27', 'U28', 'U29', 'U30', 'U31', 'U32', 'U33', 'U34', 'U35', 'U36', 'U37', 'U38', 'U39', 'U40', 'U41', 'U42', 'U43', 'U44', 'U45', 'U46', 'U47', 'U48', 'U49', 'U50', 'U51', 'U52', 'U53', 'U54', 'U55', 'U56', 'U57', 'U58', 'U59', 'U60', 'U61', 'U62', 'U63', 'U64', 'U65', 'U66', 'U67', 'U68', 'U69', 'U70', 'U71', 'U72', 'U73', 'U74', 'U75', 'U76', 'U77', 'U78', 'U79', 'U80', 'U81', 'U82', 'U83', 'U84', 'U85', 'U86', 'U87', 'U88', 'U89', 'U90', 'U91', 'U92', 'U93', 'U94', 'U95', 'U96', 'U97', 'U98', 'U99', 'U100'. Below the diagram is a 3D illustration of the outdoor unit with a callout line pointing to the control box area.</p>
--	---

**Table 29. High Voltage Disconnect Switch**

<div style="background-color: black; color: white; padding: 5px; text-align: center;"><b>⚠ WARNING</b></div> <p><b>HIGH LEAKAGE CURRENT!</b>          Failure to follow this Warning could result in property damage, severe personal injury, or death. Earth connection essential before connecting electrical supply.</p> <div style="background-color: black; color: white; padding: 5px; text-align: center;"><b>⚠ WARNING</b></div> <p><b>REMOVE POWER!</b>          Remove power when servicing.</p> <p>Install a separate disconnect switch at the outdoor unit.</p> <p>For high voltage connections, flexible electrical conduit is recommended whenever vibration transmission may create a noise problem within the structure.</p>	 <p>The illustration shows the outdoor unit with a disconnect switch connected to the side of the unit by a cable.</p>
--	--

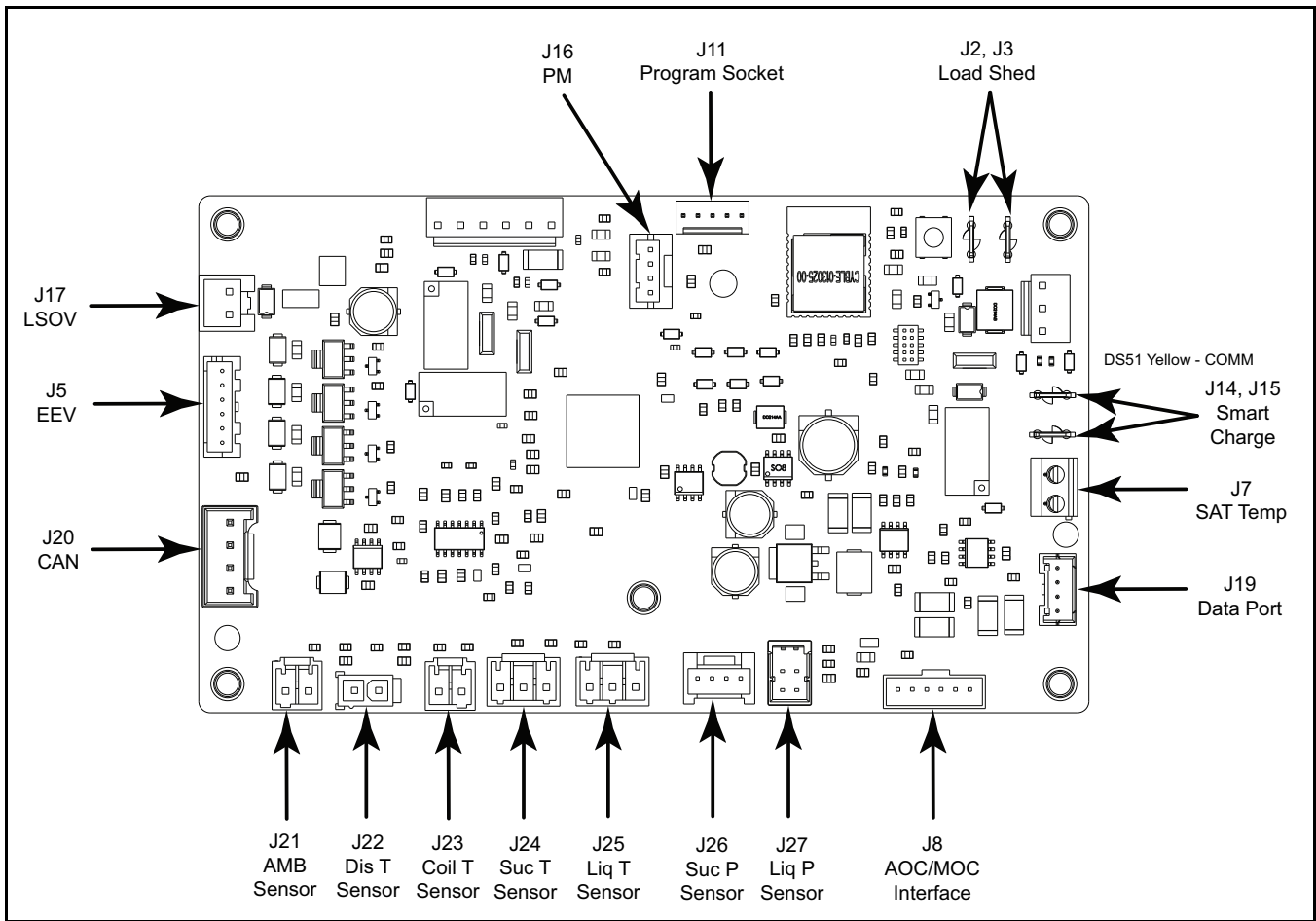
**Table 30. High Voltage Disconnect Switch**

<p>Ground the outdoor unit per national, state, and local code requirements.</p>	 <p>The symbol consists of a vertical line with a horizontal line at the bottom, and a small horizontal line below that, representing a ground connection.</p>
--	---

**Table 31. Cabling**

<div style="background-color: black; color: white; padding: 5px;"><b>⚠ WARNING</b></div> <p><b>CABLING SAFETY!</b>          Check that cabling will not be subject to wear, corrosion, excessive pressure, vibration, sharp edges or any other adverse environmental effects.</p>
---

# Integrated Variable Speed Control Board LED Indicators



**Table 32. LEDs in Link mode**

LED	RATE	DESCRIPTION	INDICATION
COMM (AMBER)	SLOW	1 TIME PER DEVICE	DEVICE COUNT
	FAST	5 TIME PER SECOND	LOSS OF COMMUNICATION

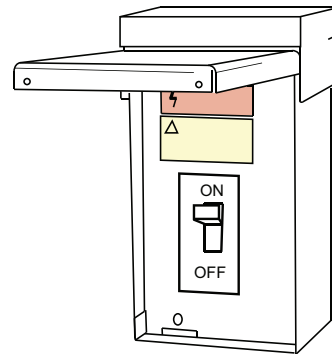
# Start Up

1. Ensure you have completed the following sections. "Refrigerant Line Brazing," p. 18 through "Electrical – High Voltage," p. 26

2. Set System Thermostat to OFF.



3. Turn ON disconnect(s) to apply power to the indoor and outdoor units.



4. Wait 3 hours before starting the unit if the outdoor ambient temperature is below 85° F.



5. Run the system using the "Charging Mode-Cooling" test mode found in the UX360 Smart Thermostat controls. Link systems can also use the Diagnostic Mobile App to enter Test Modes. This is the only approved method for setting the system charge level by subcooling.

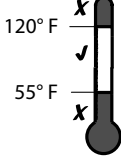
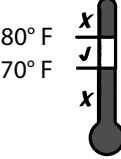
Follow the on-screen prompts.





# System Charge Adjustment

**Table 33. Temperature Measurements**

<p>Check the outdoor temperatures.</p> <p>Subcooling using <b>"Charging Mode-Cooling"</b> (see Note below) is the only recommended method of charging between 55 ° F and 120° F ambient outdoor temperature.</p> <p>Use SmartCharge™ Tool (BAYCAKT002) as an optional system charging method. Confirm charge afterward by verifying subcooling.</p>	
<p>For best results the indoor temperature should be kept between 70° F to 80° F.</p>	

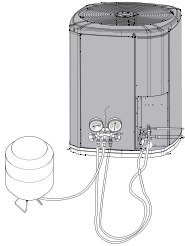
**Table 34. Subcooling Charging Corrections**

<p>Determine the final subcooling value using total Line Length and Lift measured in "Required Refrigerant Line Length" and the "Subcooling Charging Corrections Charts".</p>	<p><b>Subcooling Charging Correction Worksheet</b></p> <p>Total Line Length (ft) _____</p> <p>Total Vertical Charge (lift) _____  <i>(Values from — Required Refrigerant Line Length)</i></p> <p>Design Subcooling Value _____  <i>(from nameplate or Service Facts)</i></p> <p><b>Final Subcooling Value</b> _____</p>
---	---


**Note:** The only mode approved for setting or validating system charge is using Charging Mode-Cooling. Charging Mode-Cooling is a variable speed test mode found in the UX360 comfort control Technician Menu's. Test modes can also be accessed using the Diagnostic Mobile App. Outdoor Temperature must be between 55°F and 120°F with Indoor Temperature kept between 70°F and 80°F. If starting up in colder conditions, will need to return when the conditions are correct to validate refrigerant charge.

# Charging the Unit

**Table 35. Proper Gage Pressure**

<p>Using the Standard R-454B Subcool Charging Chart, adjust refrigerant level to attain proper gage pressure.</p> <p><b>Note:</b> Use bubble point, per the included chart, for calculating subcooling.</p> <p>Add refrigerant if the Liquid Gage Pressure is lower than the chart value.</p> <ol style="list-style-type: none"> <li>1. Connect gauges to refrigerant bottle and unit as illustrated.</li> <li>2. Purge all hoses.</li> <li>3. Place refrigerant bottle on a scale and then open bottle.</li> <li>4. Stop adding refrigerant when liquid line temperature and Liquid Gage Pressure match the charging chart.</li> </ol> <p><b>Note:</b> Recover refrigerant if the Liquid Gage Pressure is higher than the chart value.</p> <p><b>Note:</b> Ensure that contamination of different refrigerants does not occur when using charging equipment. Cylinders shall be kept in an appropriate position according to the instructions. Ensure that the REFRIGERATING SYSTEM is earthed prior to charging the system with refrigerant.</p>	
--	---

**Table 36. Stabilize the system**

<ol style="list-style-type: none"> <li>5. Wait 20 minutes for the system condition to stabilize between adjustments.</li> </ol> <p><b>Note:</b> When the Liquid Line Temperature and Gage Pressure approximately match the chart, the system is properly charged.</p> <ol style="list-style-type: none"> <li>6. Remove gauges.</li> <li>7. Replace service port caps to prevent leaks. Tighten finger tight plus an additional 1/6 turn.</li> </ol>	
---	--

**Table 37. System Information**

<p>8. Record system pressures and temperatures after charging is complete.</p> <p>Outdoor model number = _____</p> <p>Measured Outdoor Ambient = _____ °F</p> <p>Measured Indoor Ambient = _____ °F</p> <p>Measured Liquid Line Temp = _____ °F</p> <p>Measured Suction Line Temp = _____ °F</p>	<p>Indoor Wet Bulb = _____ °F</p> <p>Liquid Gage Pressure = _____ PSIG</p> <p>Suction Gage Pressure = _____ PSIG</p>
--	--

**Table 38. Total System Charge**

<p>9. Complete the "Total System Charge" chart rating label below and label located on the outside of the unit with a permanent marker.</p> <ol style="list-style-type: none"> <li>a. Charge added at Factory = _____ lb/oz</li> <li>b. Charge added at install = _____ lb/oz</li> <li>c. Total System Charge (a + b) = _____ lb/oz</li> </ol>	
--	--



# Charging Below 55° F Outdoor Temperature in Heating Mode

**Table 39. Charging below 55° F outdoor temperature in heating mode**

The Subcooling Charging method in cooling is **not** recommended below 55° F outdoor temperature.

The only recommended method of charging at outdoor temperatures below 55° F is weighing in the charge in **heating mode**.

**STEP 1** - Determine additional charge.

**Note:** The nameplate charge value represents the amount of refrigerant shipped in the outdoor unit and is compatible with 10 feet of AHRI rated refrigerant lines and the smallest AHRI rated coil.

Weigh-In Method can be used for the initial installation, or anytime a system charge is being replaced. Weigh-In Method can also be used when power is not available to the equipment site or operating conditions (indoor/outdoor temperatures) are not in range to verify with the subcooling charging method.

Using the method below, find the charge associated with the additional length of tubing above 10 ft. and record it below.

**Calculating Charge Using the Weigh-In Method**

- |  |  |
|--|--|
| <ol style="list-style-type: none"> <li>1. Measure in feet the distance between the outdoor unit and the indoor unit. (Include the entire length of the line from the service valve to the IDU.) Subtract 10 ft from this entire length and record on line 1.</li> <li>2. Enter the charge multiplier (0.47 oz./ft for 3/8" &amp; 0.30 oz./ft for 5/16").</li> <li>3. Multiply the total length of refrigerant tubing (Line 1) times the value on Step 2. Record the result on Line 3 of the Worksheet.</li> <li>4. This is the amount of refrigerant to weigh-in prior to opening the service valves.</li> </ol> | <ol style="list-style-type: none"> <li>1. Total Line length (ft) -10 ft _____</li> <li>2. Charge multiplier = for 3/8", use .47 oz. per foot and for 5/16", use .30 oz. per foot</li> <li>3. Step 1 x Step 2 = _____</li> <li>4. Refrigerant (oz) = _____</li> </ol> |
|--|--|

**STEP 2** - Stabilize the system by operating for a minimum of 20 minutes.

At startup, or whenever charge is removed or added, the system must be operated for a minimum of 20 minutes to stabilize before accurate measurements can be made.



**STEP 3** - Complete the "Total System Charge" chart rating label below and label located on the outside of the unit with a permanent marker.

**Note:** Complete the "Total System Charge" chart when final charging is complete.

- a. Charge added at Factory = \_\_\_\_\_ lb/oz
- b. Charge added at install = \_\_\_\_\_ lb/oz
- c. Total System Charge (a + b) = \_\_\_\_\_ lb/oz

**STEP 4** - Return to site for adjustment.

**Important:** Return in the spring or summer to accurately charge the system in the "Charging Mode - Cooling" with outdoor ambient **above 55° F**.



# Defrost Control (Heat Pump only)

## Demand Defrost

The demand defrost control measures heat pump outdoor ambient temperature with a sensor located outside the outdoor coil. A second sensor located on the outdoor coil is used to measure the coil temperature. The difference between the ambient and the colder coil temperature is the difference or delta-T measurement. This delta-T measurement is representative of the operating state and relative capacity of the heat pump system. By measuring the change in delta-T, we can determine the need for defrost. The coil sensor also serves to sense outdoor coil temperature for termination of the defrost cycle.

## Fault Identification

A fault condition is indicated by the UX360 User Interface or Diagnostic Mobile App.

## Defrost Enabled

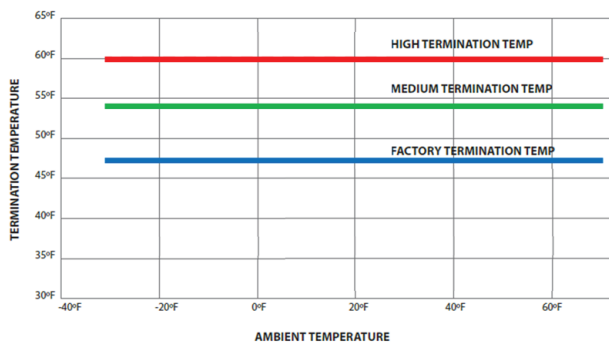
Demand Defrost is enabled with the following inputs to the Integrated Variable Speed Control (IVSC):

- Outdoor ambient temperature sensor (ODS-B) reporting an outdoor temperature at or below 52° F.
- Coil temperature sensor (CBS) reporting a coil temperature at or below 35° F.
- Heat/Cool Demand (HCD) from the communicating comfort control for at least two minutes or more.

## Defrost Initiation

The calculated temperature difference between the outdoor temperature sensor and the coil temperature sensor is called Delta T. Defrost can occur once the current Delta T exceeds the Delta T initiate value. This adaptive logic assures a complete defrost for a range of outdoor temperatures.

DEFROST TERMINATION PROFILES



**Note:** A forced Defrost test can be entered through the UX360 thermostats or the Link Diagnostic Mobile App.

## NOTES: Forced Defrost

1. System must be running with demand from the thermostat.
  2. FRC DFT TEST can be initiated in heat mode only. DFC TEST can be entered from the UX360 User Interface or Diagnostic Mobile App.
  3. Press ENTER to begin forced defrost.
  4. Execute Forced Defrost following Forced Defrost (Defrost terminates on Coil Temperature or maximum time override of 15 minutes).
  5. When test begins, TEST IN PROGRESS displays and Coil Temperature value.
- Note:** UX360 Home screen will display DEFROST.
6. When test is complete, TEST COMPLETE displays for 10 seconds.
  7. If there is a defrost fault condition, test terminates and sends alert to the alert menu.
  8. For more information, refer to the Alert Code Tables in Service Facts and Technical Service Manual (Pub. No. 34-4301-01 or newer) documents.

**Note:** Screens will update as the test proceeds.

**Note:** Installation, servicing and troubleshooting is done via Technician Access area of the thermostat and/or the Link Diagnostic Mobile App.

**Note:** Defrost termination temperature can be configured in the "Environment" section of the configuration menu.

**⚠ WARNING**

**DEFROST CONTROL!**

- Do not use means to accelerate the defrosting process or to clean, other than those recommended by the manufacturer.
- The appliance shall be stored in a room without continuously operating ignition sources (for example: open flames, an operating gas appliance or an operating electric heater).
- Do not pierce or burn.
- Be aware that refrigerants may not contain an odour.












# Checkout Procedures

The final phase of the installation is the system Checkout Procedures. The following list represents the most common items covered in a Checkout Procedure. Confirm all requirements in this document have been met.

<ul style="list-style-type: none"><li><input type="checkbox"/> All wiring connections are tight and properly secured.</li><li><input type="checkbox"/> Voltage and running current are within limits.</li><li><input type="checkbox"/> All refrigerant lines (internal and external to equipment) are isolated, secure, and not in direct contact with each other or structure.</li><li><input type="checkbox"/> All braze connections have been checked for leaks. A vacuum of 350 microns provides confirmation that the refrigeration system is leak free and dry. Additional refrigerant weight is recorded on a label by the unit nameplate.</li><li><input type="checkbox"/> Final unit inspection to confirm factory tubing has not shifted during shipment. Adjust tubing if necessary so tubes do not rub against each other or any component when unit runs.</li><li><input type="checkbox"/> Ductwork is sealed and insulated.</li><li><input type="checkbox"/> All drain lines are clear with joints properly sealed. Pour water into drain pan to confirm proper drainage. Provide enough water to ensure drain trap is primed.</li></ul>	<ul style="list-style-type: none"><li><input type="checkbox"/> Supply registers and return grilles are open, unobstructed, and air filter is installed.</li><li><input type="checkbox"/> Indoor blower and outdoor fan are operating smoothly and without obstruction.</li><li><input type="checkbox"/> Indoor airflow configured for desired comfort or efficiency in UX360 Control Configuration Section in Technician Access Area. For most efficient operation (including any CVP testing), select "More Efficient" in Compressor Heating and Cooling.</li><li><input type="checkbox"/> Verify blower and fan set screws are tight.</li><li><input type="checkbox"/> Cover panels are in place and properly tightened.</li><li><input type="checkbox"/> System functions safely and properly in all modes.</li><li><input type="checkbox"/> Owner has been instructed on use of system and given manual.</li><li><input type="checkbox"/> ENSURE Refrigerant Leak Detection system is operational.</li><li><input type="checkbox"/> ENSURE refrigerant quantity is marked on OD unit.</li></ul>
--	---

# Symbols

	<p>[symbol ISO 7010-W021 (2011-05)]</p>	<p>warning; flammable materials</p>
	<p>[symbol ISO 7000-1659 (2004-01)]</p>	<p>service indicator; read technical manual</p>
	<p>A2L symbol</p>	<p>warning; low burning velocity material</p>
	<p>[symbol ISO 7000-1701 (2004-01)]</p>	<p>pressure</p>
	<p>[symbol IEC 60417-6040 (2010-08)]</p>	<p>ultraviolet radiation, instructional safeguard</p>
	<p>[symbol ISO 7000-1641 (2004-01)]</p>	<p>operator's manual; operating instructions</p>

	<p>Refrigerant class per ISO 817</p>
---	--



# Notices

## FCC Notice

Contains FCC ID: WAP3025

*This device complies with part 15 of the FCC Rules. Operation is subject to the following two conditions: (1) This device may not cause harmful interference, and (2) this device must accept any interference received, including interference that may cause undesired operation. The antenna(s) used for this transmitter must be installed to provide a separation distance of at least 20 cm from all persons and must not be collocated or operating in conjunction with any other antenna or transmitter.*

*This equipment has been tested and found to comply with the limits for Class B Digital Device, pursuant to Part 15 of the FCC Rules. These limits are designed to provide reasonable protection against harmful interference in a residential installation. This equipment generates and can radiate radio frequency energy and, if not installed and used in accordance with the instructions, may cause harmful interference to radio communications. However, there is no guarantee that interference will not occur in a particular installation. If this equipment does cause harmful interference to radio or television reception, which can be determined by turning the equipment off and on, the user is encouraged to try to correct the interference by one or more of the following measures.*

- *Reorient or relocate the receiving antenna*
- *Increase the separation between the equipment and receiver*
- *Connect the equipment into an outlet on a circuit different from that to which the receiver is connected*
- *Consult the dealer or an experienced radio/TV technician for help*

*Any changes or modifications not expressly approved by the party responsible for compliance could void the user's authority to operate the equipment.*

## IC Notice

Contains IC ID: 7922A-3025

*This device complies with Industry Canada license exempt RSS standard(s). Operation is subject to the following two conditions: (1) this device may not cause interference, and (2) this device must accept any interference, including interference that may cause undesired operation of the device.*

*Le présent appareil est conforme aux CNR d'Industrie Canada applicables aux appareils radio exempts de licence. L'exploitation est autorisée aux deux conditions suivantes: (1) l'appareil de doit pas produire de brouillage, et (2) l'utilisateur de l'appareil doit accepter tout brouillage radioélectrique subi, même si le brouillage est susceptible d'en compromettre le fonctionnement.*



Trane - by Trane Technologies (NYSE: TT), a global innovator - creates comfortable, energy efficient indoor environments for commercial and residential applications. For more information, please visit [trane.com](http://trane.com) or [tranetechnologies.com](http://tranetechnologies.com).



The AHRI Certified mark indicates Trane U.S. Inc. participation in the AHRI Certification program. For verification of individual certified products, go to [ahridirectory.org](http://ahridirectory.org).

Trane has a policy of continuous data improvement and it reserves the right to change design and specifications without notice. We are committed to using environmentally conscious print practices.