



It's Hard To Stop A Trane.®

PRODUCT HANDBOOK

RESIDENTIAL & LIGHT COMMERCIAL JANUARY 2023



DIAGNOSE IT

...BEFORE YOU EVEN ROLL A TRUCK!

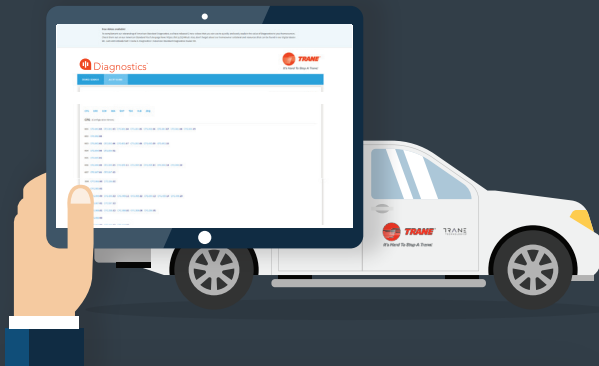

Get both real-time and historical HVAC system performance data through Trane® Diagnostics. Remotely monitor a customer's system and diagnose any potential problems anytime, anywhere.

Compatible with Trane smart thermostats.

✓ **PERFORMANCE ALERTS
(CURRENT AND HISTORICAL)**

→ Email your team members a detailed report generated by the system.

✓ **SYSTEM STATUS**

→ View heating and cooling setpoints, relative humidity, indoor and outdoor temperature, system mode, etc.

✓ **SYSTEM CONFIGURATIONS**

→ Get detailed information on the system components.

✓ **30-DAY RUNTIME
HISTORY AND DATA**

→ See how the system performed and pinpoint issues that may have occurred—all in one simple dashboard.

✓ **REMOTE CONFIGURATION**

→ With a homeowner's permission, access their thermostat interface to trouble-shoot or configure remotely.

How do I access Trane Diagnostics?

Visit Diagnostics.TraneHome.com

Or go to ComfortSite ▶ Home & Diagnostics ▶ Trane Diagnostics

Need Help? 844-359-0270 dealerdiags@tranehome.com

Contents - Residential

Model Nomenclature	TOC-5
Connected Home Solutions	
• Trane® Link System Controller and Smart Thermostat	CHS-1
• Conventional 24 Volt Smart Thermostat	CHS-2
• ComfortLink™ II Communicating Smart Thermostat	CHS-3
• Trane Home™ Compatible Products	CHS-4
Split System Cooling	
• TruComfort™ Variable Speed Single Phase, 2-5 Tons (4TTV0, 4TTV8)	SC-1
• Single Phase, 1½-5 Tons (4TTX7, 4TTX5)	SC-3
• Single Phase, 1½-5 Tons (4TTR6, 4TTR5, 4TTL5)	SC-5
• Single Phase, 1½-5 Tons (4TTR4, 4TTR3)	SC-7
• Three Phase (4TTA7, 4TTA4, 4TTA3)	SC-9
Split System Heat Pumps	
• TruComfort™ Variable Speed Single Phase, 2-5 Tons (4TWW0, 4TWL9, 4TWW8) ..	SH-1
• Single Phase, 1½-5 Tons (4TWX7, 4TWX5)	SH-3
• Single Phase, 1½-5 Tons (4TWR6, 4TWR5, 4TWL5)	SH-5
• Single Phase, 1½-5 Tons (4TWR4)	SH-7
• Three Phase (4TWA7, 4TWA4)	SH-9
Air Handlers/Heaters	
• Features and Benefits	AH-1
• Hyperion, TAMX, TAM9 Variable Speed Multi-Position, 2-5 Tons (TAMX, TAM9)	AH-2
• Multi-position Chart	AH-5
• Hyperion, GAM5 Multi-Position, Single Phase, 1½-5 Tons (GAM5)	AH-6
• Heaters for Hyperion Multi-Position	AH-8
• TEM Split System, Single Phase, 1½-5 Tons (TEM8, TEM6, TEM4)	AH-10
• Heaters for TEM	AH-12
• TMM Wall, Stud, or Over the Water Heater Mount Air Handlers Single Phase, 1½-3 Tons (TMM5, TMM4)	AH-14
• P-Series Modular Blower - Variable Speed (CALIFORNIA ONLY)	AH-16
Coils	
• Split System Aluminum Cased Heat Pump and Cooling (4TXC-DS, 4PXC-U, 4PXC-D)	COIL-1
• Split System Aluminum Uncased Heat Pump and Cooling (4AXA, 4PXA-U)	COIL-2
• Split System Aluminum Cased Heat Pump and Cooling (4PXF)	COIL-3
• Split System Aluminum Cased Heat Pump and Cooling (4MXC)	COIL-4
Furnaces	
• S9V2-VS, S9V2 Two Stage Variable Speed ECM	FUR-1
• S9X2 Two Stage High Efficiency ECM	FUR-2
• S9V2-VS, S9V2, S9X2 Features & Accessories	FUR-3
• S9X1, S9B1 Single Stage High Efficiency ECM	FUR-4
• S9X1, S9B1 Features & Accessories	FUR-5
• XC95m Airflow Directions	FUR-6
• XC95m Modulating Communicating Variable Speed (TUHM, TDHM)	FUR-7
• XC95m Features & Accessories	FUR-8
• Special Use Furnace Accessories	FUR-9
• S8V2-C Two Stage Communicating ECM Variable Speed	FUR-10
• S8X2 Two Stage ECM	FUR-10
• S8X1, S8B1 Single Stage ECM	FUR-11
• S8V2-C, S8X2, S8X1, S8B1 Features & Accessories	FUR-12
• XC80, XV80 Airflow Directions	FUR-14
• XC80 Communicating Convertible (TUD2-ACV, TDD2-ACV)	FUR-15
• XV80 Two Stage Variable Speed (TUD2, TDD2)	FUR-15
• XC80, XV80 Features & Accessories	FUR-16
• High Efficiency Oil Furnaces Ordering Information	FUR-18
• L8V1 Single Stage, Variable Speed, Ultra-Low NOx Gas Furnace (CALIFORNIA ONLY)	FUR-19
• L8X1 Single Stage, Ultra-Low NOx Gas Furnace (CALIFORNIA ONLY)	FUR-19
• L9X1 Single Stage, Ultra-Low NOx Gas Furnace (CALIFORNIA ONLY)	FUR-20

This publication is for general reference information only and is not intended for systems equipment / combination selections.

For complete equipment / combination selections, installation instructions and warranty information please refer to Product Data/Ratings and/or Installers Guides and Limited Warranty Handbooks.

Products listed in this book are not always carried in factory/distributor inventory, nor are all products available through all distribution channels. Consult your Distributor for availability and shipping information.

Since Trane has a policy of continuous product improvement, it reserves the right to change design and specification without notice.

Contents - Residential

Indoor Air Quality

- Trane CleanEffects™ Whole House Air Cleaner (EFD)..... IAQ-1
- Perfect Fit™ Filter Accessories and SlimFit Filters..... IAQ-2
- QuikBox™ Media Cabinet and Filters..... IAQ-3
- Humidifiers Steam IAQ-4
- Humidifiers Fan Powered and Bypass IAQ-5
- Whole Home Dehumidifiers with optional Ventilation..... IAQ-6
- Inline Ventilators (QF130V) IAQ-7
- Energy Recovery Ventilator (ERV)..... IAQ-8

Smart Thermostats/Zone Sensors

- Conventional 24 Volt Smart Thermostat..... CCZO-1
- Trane® Link System Controller and Smart Thermostat..... CCZO-3
- ComfortLink™ II Communicating Smart Thermostat..... CCZO-4
- Zoning Communicating Sensor with Display..... CCZO-6
- Trane® Pivot™ Commercial Thermostats CCZO-7
- Conventional 24 Volt HVAC System Interface Relay Panel for
ComfortLink™ Controls..... CCZO-8
- Trane® Link System Component Overview CCZO-9
- ComfortLink™ II XL1050 Control Component Overview CCZO-10
- ComfortLink™ II Zoning Assembly & Zone Expander Panel CCZO-11
- ComfortLink™ II Zoning Component Overview CCZO-12
- 24 Volt Modulating Dampers..... CCZO-14
- Programmable Touchscreen Thermostats CCZO-19
- Programmable Thermostats CCZO-20
- Non-Programmable Comfort Controls CCZO-21
- Remote Sensors..... CCZO-23
- Outdoor Thermostat Kit CCZO-24

Packaged Units

- Cooling Convertible, 2-5 Tons (4TCC4) PK-1
- Hybrid/Dual Fuel Convertible, 2-5 Tons (4DCZ5)..... PK-4
- Heat Pump Convertible, 2-5 Tons (4WCZ6, 4WCZ5, 4WCY4, 4WCC4) PK-7
- Heat Pump Over/Under 2-3.5 Tons (4WHC4)..... PK-10
- Gas/Electric Convertible, 2-5 Tons (4YCZ6, 4YCZ5, 4YCY4, 4YCC4)..... PK-11
- Convertible, 2-5 Tons Single Power Entry Kits PK-14
- Convertible, 2-5 Tons Supplemental Heaters PK-15

RunTru™

- Model Nomenclature..... RTNOM-1
- Split System Cooling Single Phase – 1½-5 Tons (A4AC3, A4AC4, A4AC5) RTSC-1
- Split System Heat Pumps Single Phase – 1½-5 Tons (A4HP4, A4HP5, E4HL5) .. RTSH-1
- Split System Air Handlers Single Phase 1½-5 Tons (A4AH4, A4AH5, E4AH5) ... RTAH-1
- TMM Wall, Stud, or Over the Water Heater Mount
Air Handlers Single Phase, 1½-3 Tons (TMM5, TMM4) RTAH-4
- Split System – Cased Heat Pump and Cooling Coils (4MXC) RTCOIL-1
- A801X - Single Stage ECM (A801X)..... RTFUR-1
- A951X - Single Stage ECM (A951X)..... RTFUR-3
- A952V - Two Stage, Variable Speed ECM (A952V)..... RTFUR-3
- Packaged Cooling Convertible 2-5 Tons (4TCA4)..... RTPK-1
- Packaged Heat Pump Convertible 2-5 Tons (4WCA4)..... RTPK-3

Accessories/Information

- Roof Curbs (BAYCURB050A, BAYCURB051A) AC/IN-1
- Thermal Expansion Valves AC/IN-2
- Equipment Date Identification AC/IN-4
- Refrigerant Line Sets..... AC/IN-5
- Refrigerant HFC 410A (R-410A) AC/IN-6
- Refrigerant Piping Information for Two Stage Split Systems AC/IN-7
- Split Systems with Side Discharge Variable Speed Compressor AC/IN-8
- Branch Circuit Wire Sizing Table/Heater De-Rating Chart AC/IN-9
- Basic Air Conditioning Formulas AC/IN-10
- Low Ambient Cooling Operation Accessories AC/IN-11

Contents - Light Commercial

Split System Cooling

- Odyssey with Symbio™ Single Circuit, Three Phase, 6-25 Tons, R-410A (TTA).... LSC-1
- Odyssey with Symbio™ Dual Circuit, Three Phase, 6-25 Tons, R-410A (TTA)..... LSC-2
- Three Phase, 6-25 Tons, R-410A Condenser Accessories..... LSC-3
- Three Phase, 6-25 Tons, Control Options LSC-4

Split System Heat Pumps

- Odyssey with Symbio™ Three Phase, 6-20 Tons, R-410A (TWA) LSH-1
- Three Phase, 6-20 Tons, R-410A Accessories..... LSH-2
- Three Phase, 6-20 Tons, Controls..... LSH-2

Air Handlers/Heaters

- Odyssey with Symbio™ Single Phase 5-10 Tons, Three Phase 5-25 Tons (TWE) ..LAH-1
- Heaters for Single and Three Phase..... LAH-3
- Accessories for Single and Three Phase LAH-4

Packaged Cooling

- Precedent™ Convertible, 3-5 Tons Features..... LPC-1
- Precedent™ Convertible, 3-5 Tons, R-410A (THC, TSC) LPC-2
- Precedent™ Convertible, 3-5 Tons Model Digit Numbers..... LPC-3
- Precedent™ Convertible, 3-5 Tons, Electric Heaters..... LPC-5
- Precedent™ Convertible, 3-5 Tons Accessories..... LPC-6
- Precedent™ Convertible, 3-5 Tons Zone Sensors/Thermostats..... LPC-8
- ReliaTel™ Controls for Precedent™
(Packaged Unit Protection/Operation Timings and Features) LPC-9
- Precedent™ with Symbio™ Convertible, 6-25 Tons Features LPC-10
- Precedent™ with Symbio™ Convertible, 6-25 Tons, R-410A (THJ, TSC)..... LPC-11
- Precedent™ with Symbio™ Convertible, 6-25 Tons Model Digit Numbers..... LPC-13
- Precedent™ with Symbio™ Convertible, 6-25 Tons, Electric Heaters LPC-14
- Precedent™ with Symbio™ Convertible, 6-25 Tons Accessories LPC-15
- Foundation™ 3-5 Tons, R-410A (EBC)..... LPC-16
- Foundation™ 3-5 Tons, R-410A (Model Digit Numbers)..... LPC-17
- Foundation™ 3-5 Tons, Accessories LPC-18
- Foundation™ 3-5 Tons, Heaters LPC-19
- Medium Foundation™ 7.5-12.5 Tons, R-410A (ECC) LPC-20
- Medium Foundation™ 7.5-12.5 Tons, R-410A (Model Digit Numbers) LPC-21
- Medium Foundation™ 7.5-12.5 Tons Accessories..... LPC-22
- Medium Foundation™ 7.5-12.5 Tons Heaters LPC-23
- Foundation™ 15-25 Tons, R-410A (ECC)..... LPC-24
- Foundation™ 15-25 Tons, R-410A (Model Digit Numbers)..... LPC-25
- Foundation™ 15-25 Tons, Accessories LPC-26
- Foundation™ 15-25 Tons, Heaters LPC-27

Packaged Heating

- Precedent™ Convertible, 3-10 Tons Features..... LPH-1
- Precedent™ Convertible, 3-10 Tons, R-410A (WHC/DHC) LPH-2
- Precedent™ Convertible, 3-10 Tons, R-410A (WSC) LPH-4
- Precedent™ Convertible, 3-10 Tons Model Digit Numbers..... LPH-5
- Precedent™ Convertible, 3-10 Tons Electric Heaters..... LPH-7
- Precedent™ Convertible, 3-10 Tons, Electric Heaters and Zone Sensors LPH-8
- Precedent™ Convertible, 3-10 Tons Accessories..... LPH-9
- Precedent™ with Symbio™ Convertible, 12.5-25 Tons Features LPH-11
- Precedent™ with Symbio™ Convertible, 12.5-25 Tons, R-410A
(WHJ, DHJ, WSJ, DSJ)..... LPH-12
- Precedent™ with Symbio™ Convertible, 12.5-25 Tons Model Digit Numbers..LPH-14
- Precedent™ with Symbio™ Convertible, 12.5-25 Tons Accessories LPH-15

Contents - Light Commercial

Packaged Gas/Electric

- Precedent™ Convertible, 3-5 Tons Features..... LPG-1
- Precedent™ Convertible, 3-5 Tons, 17 SEER, R-410A (YHC)..... LPG-2
- Precedent™ Convertible, 3-5 Tons, 15 SEER, R-410A (YHC)..... LPG-3
- Precedent™ Convertible, 3-5 Tons, 14 SEER, R-410A (YSC-G)..... LPG-4
- Precedent™ Convertible, 3-5 Tons Model Digit Numbers..... LPG-5
- Precedent™ Convertible, 3-5 Tons Accessories..... LPG-7
- Precedent™ Convertible, 3-5 Tons Zone Sensors/Thermostats..... LPG-9
- Precedent™ with Symbio™ Convertible, 6-25 Tons Features LPG-10
- Precedent™ with Symbio™ Convertible, 6-25 Tons,
High Efficiency, R-410A (YHJ)..... LPG-11
- Precedent™ with Symbio™ Convertible, 6-25 Tons,
Standard Efficiency, R-410A (YSJ)..... LPG-13
- Precedent™ with Symbio™ Convertible, 6-25 Tons Model Digit Numbers..... LPG-15
- Precedent™ with Symbio™ Convertible, 6-25 Tons Accessories LPC-16
- Foundation™, 3-5 Tons, R-410A (GBC) LPG-17
- Foundation™, 3-5 Tons, R-410A (Model Digit Numbers) LPG-18
- Foundation™, 3-5 Tons, R-410A Accessories..... LPG-19
- Medium Foundation™ 7.5-12.5 Tons, R-410A (GCC)..... LPG-20
- Medium Foundation™ 7.5-12.5 Tons, R-410A (Model Digit Numbers) LPG-21
- Medium Foundation™ 7.5-12.5 Tons Accessories..... LPG-22
- Foundation™, 15-25 Tons, R-410A (GCC) LPG-23
- Foundation™, 15-25 Tons, R-410A (Model Digit Numbers)..... LPG-24
- Foundation™, 15-25 Tons Accessories LPG-25

Accessories/Information

- Roof Curb Compatibility Information LAC/IN-1
- Odyssey Footprint Information..... LAC/IN-2

Comfort Controls/Zone Sensors

- Zone Sensors..... LCCZO-1
- Air-Fi Wireless Communicating Zone Sensors LCCZO-3
- Thermostats..... LCCZO-4



It's Hard To Stop A Trane.®

Model Nomenclature Residential

Outdoor Units

1 2 3 4 5 6 7 8 9 10 11 12 13 14 15
4 T T R 4 0 6 0 A 1 0 0 0 A A

Refrigerant Type
2 = R-22
4 = R-410A

Brand
T = Trane

System Type
T = AC
W = HP

Product Family
A = Light Commercial R = XR
B = XB V = VSD
L = Side Discharge X = XL
M = XM/XB 300 Z = 2 Recip 20 SEER

Nominal Rated SEER2
0 = 10 or 20 SEER2 6 = 16 SEER2
3 = 13 SEER2 7 = 17 SEER2
4 = 14 SEER2 8 = 18 SEER2
5 = 15 SEER2 9 = 19 SEER2

Field Connection
0 = Brazed
5 = Mechanical

Nominal Tonnage
12 = 1.0 24 = 2.0 36 = 3.0 48 = 4.0 72 = 6.0
18 = 1.5 25 = 2.0 37 = 3.0 49 = 4.0
19 = 1.5 30 = 2.5 42 = 3.5 60 = 5.0
31 = 2.5 43 = 3.5 61 = 5.0

Major Design Change
A thru Z. Note: No F, I, O

Power Supply Voltage/Phz/Hz
1 = 200-208-230/1/60 4 = 460/3/60 A = 220-240/1/50
3 = 200-230/3/60 5 = 400/3/60 D = 380-415/3/50

Other Functions
000 = Typical-no meaning QHO = Qatar w/ high capacity ID
00L = Latin America QM0 = Qatar w/ nom. capacity ID
COT = Coated PlateFin S00 = SASO Cooling Only
BH0 = Bahrain w/ high capacity ID SE0 = SASO w/ Electric Ht
BM0 = Bahrain w/ nom. capacity ID SV0 = SASO Vidalia

Minor Design Change
A thru Z. Note: No F, I, O

Service Digit - Not Orderable
A thru Z. Note: No F, I, O

Accessories

1 2 3 4 5 6 7 8 9 10 11 12
*B A Y E C O N O 0 1 A 0

Denotes: Accessories

Accessories Type (Example: BAYCURB, TAYSTAT)

ASCT = Anti-Cycle Timer	LOAM = Low Ambient Controls
BARM = Barometric Relief	LPKT = L.P. Kit
BASE = Subbase	LSDR = Low Static Drive
BRZQ = Coupling Kit Adaptors	NXKT = NOx Rod Accessory Ki
CCHT = Crankcase Heater	PANL = Panel
CLE = Coil Enclosures	PLNM = Plenum
CURB = Roof Curb	PLUS = Add-on Heat Pump
DMPR = Damper	REFLN = Refrigerant Lines
DNFLW = Downflow Conversion Kit	RLAY = Relay
ECMT = Extreme Mounting Kit	SEAC = Sea Coast Kit
ECON = Economizer	SENS = Sensor
ENTH = Enthalpy Control	SPEK = Single Power Entry Kit
FLTR = Filter	STAT = Thermostat
GARD = Coil Guard	TBKT = Thru Base Utility Kit
GRLE = Return Air Grill	TEST = Test Accessory
HALT = High Altitude Kit	TFMR = Transformer
HGBP = Hot Gas Bypass Control	TWIN = Twinning Kits
HSMT = High Static Motor	TXVA = Cooling — Bleed/Non Bleed Kits
HTRA = Electric Heater (Digit 7 Is Used To Differentiate The Products Accessory Is Used With)	TXVH = Heat Pump Non Bleed Kits
ISLT = Isolator	UTIL = Curb Ext. Kit
KSKT = Start Accessory Kit	VENT = Termination Kit
LEGS = Snow Legs	WAR = Warranty
LEGSCAP = Leveling Caps	WATR = Hydronic Heat Coils
LIFT = Lifting Lug Kit	WRKT = Wire Kit
	2STG = 2 Stage Gas

Major Design Change
Numbers Are Sequentially Assigned Except For Electric Heaters.
On Electric Heaters Digit 8 Is Used To Identify Voltage And Digit 9
And 10 Are Used To Identify Capacity In KW's.

Minor Design Change
Accessory To Unit Match-up (When Required)

Service Digit - Not Orderable

*B or T or No Digit.

For complete equipment / combination selections, installation instructions and warranty information, please refer to Product Data/Ratings and/or Installers Guides and Limited Warranty Handbooks.

Hyperion Air Handler

1 2 3 4 5 6 7 8 9 10 11 12 13 14 15
G A M 5 A 0 B 3 6 M 3 1 S A A

Brand
T or G = Trane Technologies

Product Type
A = Air Handler
E = Air Handler

Convertability
M = Multi-poise 4-way
F = Upflow Front Return, 3-way
T = 3-way

Product Tier
2 = Good, Entry Level Feature Set
4 = Better, Retail Replacement Mid Effy.
5 = Better, Entry Level High Effy., Multi-Speed
7 = Best, Retail Replacement High Effy., Variable-Speed
8 = Best, Retail Ultimate High Effy., Variable-Speed
9 = Best, Comm/24V Variable-Speed
G = Best, Geothermal

Major Design Change

No Descriptor
0 = Air Handler / Coil

Size (Footprint)
A = 17.5 x 21.8
B = 21.3 x 21.8
C = 23.5 x 21.8

Cooling Size: Air Handler or Coil
0-9 = AH Coil - 1000 BTU's (18, 24, 30, 36, 42, 48, 60)

Airflow Type & Capability
S = Standard Effy PSC, 1-5 - nom. Tonnage (cfm/ton)
M = Mid Effy Multi-Speed, 1-5 - nom. Tonnage (cfm/ton)
H = High Effy Variable, 1-5 - nom. Tonnage (cfm/ton)
V = High Effy Variable, 1-5 - nom. Tonnage (cfm/ton)

Power Supply
1 = 208-230/1/60

System Control Type
S = Standard - 24 VAC
C = CLII 13.8 VDC
D = Dual (24 VAC / CLII 13.8 VDC) and Epoxy Coated Coil Fins
E = Epoxy Coated Coil Fins

Minor Design Change

Service Digit - Not Orderable

Hyperion Air Handler Electric Heaters

1 2 3 4 5 6 7 8 9 10 11 12 13 14 15
B A Y E A A C 1 5 B K 1 A A A

Brand
B = Both Brands

Product Type
AY = Accessory

Heat Type
E = Electric Heater

Product Tier
A = TAM9, TAM4, GAM5, TAMGB
E = TAM8, TAM7
C = GAF2

Size (Footprint)
A-C = Minimum Cabiner Width

Size (Footprint)
A-C = Maximum Cabiner Width

Electric Heat Input
Electric Heat kW

Connection
BK = Breaker
LG = Lugs

Power Supply
1 = 208-230/1/60
A = 200/1/50
3 = 208-230/3/60

Major Design Modification

Minor Design Modification

Service Digit - Not Orderable



It's Hard To Stop A Trane.®

Model Nomenclature Residential

Air Handler - Residential

1 2 3 4 5 6 7 8 9 10 11 12 13 14 15
T E M 4 A 0 B 3 6 M 3 1 S A A

Brand

T = Trane

Product Type

E = Metal Cabinet
M = Metal Over Hot Water Heater

Convertability

M = Multi-poise 4-way

Product Tier

3 = Entry Level Multi-Speed
4 = Entry Level Multi-Speed
5 = Entry Level High Efficiency
6 = Entry Level Variable Speed
8 = Entry Level Comm/24V Variable Speed

Major Design Change

No Descriptor

0 = Air Handler / Coil

Size (Footprint) (W x D)

A = 20.5 x 15.0
B = 18.5 x 21.1 (TEM), 22.0 x 19.0 (TMM)
C = 23.5 x 21.1
D = 26.5 x 21.1

Cooling Size: Air Handler or Coil

0-9 = AH Coil - 1000 BTU's (18, 24, 30, 36, 42, 48, 60)

Airflow Type & Capability

S = Standard Effy, 1-5 - nom. Tonnage (cfm/ton)
M = Mid Effy Multi-Speed, 1-5 - nom. Tonnage (cfm/ton)
H = High Effy Variable, 1-5 - nom. Tonnage (cfm/ton)
V = High Effy Variable, 1-5 - nom. Tonnage (cfm/ton)

Power Supply

1 = 208-230/1/60

System Control Type

S = Standard - 24 VAC
C = CLII 13.8 VDC
D = Dual (24 VAC / CLII 13.8 VDC)

Minor Design Change

Service Digit - Not Orderable

Air Handler

1 2 3 4 5 6 7 8 9 10 11 12 13 14 15
4 F W C A 0 2 4 A 1 0 0 0 A A

Refrigerant Type

4 = R-410A

Model Type

FWC = Convertible
FWH = Convertible with Constant Torque ECM Motor
FWM = Stud Mount with Factory Installed Electric Heat
FWD = Furr-Down Uncased with Factory Installed Electric Heat
FWF = Furr-Down Cased with Factory Installed Electric Heat

Insulation

A = Standard
F = R4.2 Insulation

Capacity

Nominal Capacity in 1000's (BTUH)

Major Design Change

Power Supply

1 = Single Phase

Electrical Connection

0 = Pig Tails
D = Pull Disconnect

Electric Heater

00 = No heater
05 = 5 KW
08 = 8 KW
10 = 10 KW
15 = 15 KW
20 = 20 KW

Minor Design Change

Service Digit - Not Orderable

Air Handler/Heaters

1 2 3 4 5 6 7 8 9 10 11 12 13 14
B A Y H T R 1 4 1 5 B R K A

Accessory

Heater

Power Supply

1 = Single Phase
3 = Three Phase

Series/Family

3 = 2/4TEH Models Only
4 = 4TEC / Legacy
5 = TEM Models Only

Heater KW

Electrical Connection

000 = Pig Tails Only
BRK = Circuit Breaker
PDC = Pull Disconnect
RBR = Recessed Breaker-TVF018, TVF024, 14" Deep only
RPD = Recessed Pull Disconnect-TVF018, TVF024, 14" Deep only

Minor Design Change

For complete equipment / combination selections, installation instructions and warranty information, please refer to Product Data/Ratings and/or Installers Guides and Limited Warranty Handbooks.



It's Hard To Stop A Trane.®

Model Nomenclature Residential

Gas Furnaces

1 2 3 4 5 6 7 8 9 10 11 12 13 14 15
 T U D 1 B 0 8 0 A 9 H 3 1 A A

Furnace Configuration

TU = Upflow/Horizontal
 TD = Downflow/Horizontal

Type

E = 80% Induced Draft Standard
 D = 80% Induced Draft Premium
 C = 90% Condensing Standard
 X = 90% Condensing Premium
 H = 95% + Condensing Premium

Number of Heating Stages

1 = Single Stage
 2 = Two Stage
 M = Modulating

Cabinet Width

A = 14.5" Cabinet Width
 B = 17.5" Cabinet Width
 C = 21.0" Cabinet Width
 D = 24.5" Cabinet Width

Nominal Heating Input in 1000's (BTUH)

080 = 80,000 BTUH

Major Design Change

Voltage

9 = 115 Volts / 60 Hertz / Natural Gas
 A = 115 Volts / 50 Hertz / Natural Gas
 C = 115 Volts / Natural Gas with Communicating System Control
 F = 115 Volts / Natural Gas with Integrated Electronic Filter
 D = 115 Volts / Natural Gas with Communicating System Control and Integrated Electronic Filter

Air Capacity for Cooling

Standard PSC	Variable Speed	High Efficiency
24 = 2 Tons	V3 = 3 Tons	H3 = 3 Tons
36 = 3 Tons	V4 = 4 Tons	H4 = 4 Tons
42 = 3.5 Tons	V5 = 5 Tons	H5 = 5 Tons
45 = 4 Tons		
48 = 4 Tons		
54 = 5 Tons		
60 = 5 Tons		
72 = 6 Tons		

Draft Inducer Speeds

1 = Single Speed
 2 = Two Speed
 V = Variable Speed

Minor Design Change

Service Digit - Not Orderable

S-Series Furnaces

1 2 3 4 5 6 7 8 9 10 11 12 13 14 15
 S 8 B 1 B 0 8 0 U 2 P S A A A

Level

S = Series

AFUE

8 = 80%
 9 = 90% or Higher

Blower

B = Base model
 P = PSC
 X = CTM
 V = Variable Speed

Gas Valve Stages

1 = Single Stage
 2 = 2 Stage
 M = Modulating

Cabinet Width

A = 14.5"
 B = 17.5"
 C = 21"
 D = 24.5"

BTU Input

080 = 80,000 BTUH

Poise Options

U = 3 Way
 D = Dedicated Downflow
 M = 4 Way Poise

Air Capacity for Cooling

(in nominal tons)
 2 = 2 Tons
 3 = 3 Tons
 4 = 4 Tons
 5 = 5 Tons

Inducer Type

P = PSC
 X = CTM
 V = Variable Speed

Communicating Capability

C = Communicating System Control
 D = Communicating System Control, Low NOx
 S = 24 Volt
 T = 24 Volt, Low NOx

Major Design Change

Minor Design Change

Service Digit - Not Orderable



It's Hard To Stop A Trane.®

Model Nomenclature Residential

Heat Pump/ Cooling Coils

1 2 3 4 5 6 7 8 9 10 11 12 13 14 15
4 T X C B 0 3 6 A C 3 H C A A

- Refrigerant Type**
4 = R-410A
- Series**
T = Premium (Cooling and HP)
P = Premium High Efficiency - Dedicated position (Cooling and HP)
A = Entry Level (Cooling and HP)
M = Entry Level (Cooling and HP)
- Coil Design**
X = Direct Expansion Evaporator Coil
- Coil Feature**
C = Cased A Coil
A = Uncased A Coil
F = Cased Horizontal Flat Coil
- Coil Width (Cased/Uncased)**
A = 14.5" / 13.3" D = 24.5" / 23.3"
B = 17.5" / 16.3" H = 10.5"
C = 21.0" / 19.8"
- Refrigerant Line Coupling / Airflow Configuration**
0 = Brazed
U = Upflow only, convertible to Horizontal Left
D = Downflow only, convertible to Horizontal Right
- Nominal Capacity in 1000's (BTUH) / Model Number Distinguisher**
- Major Design Change**
- Efficiency**
C = Standard
S = High Efficiency (derived from 10 SEER products)
Z = High Efficiency (TXV modulates to 50%)
- Refrigerant Control**
3 = TXV - Non-Bleed
6 = FCCV (Flow Control/Check Valve)
- Coil Circuitry**
H = Heat Pump C = Cooling
- Airflow Configuration**
A = Upflow
U = Upflow / Downflow
D = Downflow
R = Downflow / Horizontal Right
H = Horizontal Left/Right
C = Convertible - Upflow, Downflow, Left or Right
- Minor Design Change**
- Service Digit - Not Orderable**

TXV Kits

1 2 3 4 5 6 7 8 9 10 11 12 13 14 15
2 A Y T X V H 3 A 2 5 3 1 A A

- Refrigerant**
4 = R-410A
2 = R-22
- Accessory**
- Accessory Type**
TXV Kit
- Compatibility**
Cooling & Heat Pump Compatible
- Flow Control**
3 = TXV - Non Bleed
- Major Design Change**
B = Internally Mounted (Mechanical Fittings)
C = Internally Mounted (Mechanical Fittings)
D = Internally Mounted (Mechanical Fittings)
- Minimum Nominal Capacity in 000's BTU's**
- Maximum Nominal Capacity in 000's BTU's**
- Minor Design Change**
- Service Digit - Not Orderable**

ONLINE ONLY COPY



It's Hard To Stop A Trane.®

Model Nomenclature Residential

Trane CleanEffects™ Whole House Air Cleaner

1 2 3 4 5 6 7 8 9 10 11 12 13 14 15
E F D 1 4 5 A L F R 0 0 0 C A

Brand _____
E = Dual Branded

Filtration _____

ifD _____

Size _____

Furnace Upflow	Furnace Downflow	Air Handler
145 = 14.5"	14D = 14.5"	215 = 21.5"
175 = 17.5"	17D = 17.5"	235 = 23.5"
210 = 21.0"	21D = 21.0"	260 = 26.0"
245 = 24.5"	24D = 24.5"	

Major Design Change _____

Power Supply _____
L = Low Voltage

Application _____
AH000 = Air Handler
FR000 = Furnace

Minor Design Change _____

Service Digit - Not Orderable _____

QuikBox Air Cleaner

1 2 3 4 5 6 7 8 9 10
E QB FM 175 A 0 FR 11

Brand _____
E = Dual Branded

Model _____
QB = QuikBox

Filter Type _____
FM = Filter Media

Product Dimensions _____
 165 = 16.5" Furnace Width
 175 = 17.5" Furnace Width
 210 = 21.0" Furnace Width
 245 = 24.5" Furnace Width
 17D = 17.5" Air Handler Width
 185 = 18.5" Air Handler Width
 215 = 21.5" Air Handler Width
 235 = 23.5" Air Handler Width

Major Design Change _____

Product Development Sequence _____

Application _____
AH = Air Handler
FR = Furnace

MERV Rating _____
11 = MERV 11
13 = MERV 13

Dehumidifiers

1 2 3 4 5 6 7 8 9 10 11 12 13 14 15
E D H U M 7 0 H A H M 0 0 B A

Brand _____
E = Dual Branded

Accessory Type _____
DHUM = Humidifier

Model Series _____
70H = 70 ppd, 1800 sq'
098 = 98 ppd, 2300 sq'
120 = 120 ppd, 2500 sq'

Major Design Change _____
A = Design Series

Configuration _____
H = Horizontal, Ducted Attic, Basement
V = Vertical, Closet or Limited Space
S = Split System Indoor and Outdoor Section

Voltage Supplied Wiring _____
1 = 115 VAC, 9" Cord, Grounded Plug

Controls _____
M = Wired 24V terminals

Application _____
D = Dedicated Ventilating Dehumidifier
N = Dehumidifier with optional ventilation

Minor Design Change _____

Service Digit - Not Orderable _____

QuikBox Filter Accessories

1 2 3 4 5 6
FLR QB 5 FR 17 M11

Accessory Type _____
FLR = Filter

Model _____
QB = QuikBox

Product Development Sequence _____
5 = 5" Expandable Media

Application _____
AH = Air Handler
FR = Furnace

Product Dimensions _____
 16 = 16.5" Furnace Width
 17 = 17.5" Furnace Width
 21 = 21.0" Furnace Width
 24 = 24.5" Furnace Width
 17D = 17.5" Air Handler Width
 18 = 18.5" Air Handler Width
 21 = 21.5" Air Handler Width
 23 = 23.5" Air Handler Width

MERV Rating _____
11 = MERV 11
13 = MERV 13

For complete equipment / combination selections, installation instructions and warranty information, please refer to Product Data/Ratings and/or Installers Guides and Limited Warranty Handbooks.



It's Hard To Stop A Trane.®

Model Nomenclature Residential

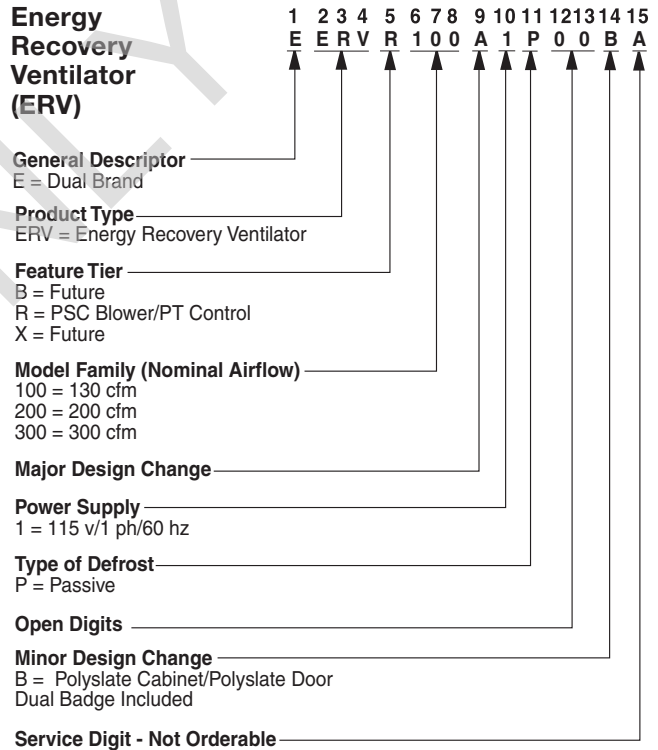
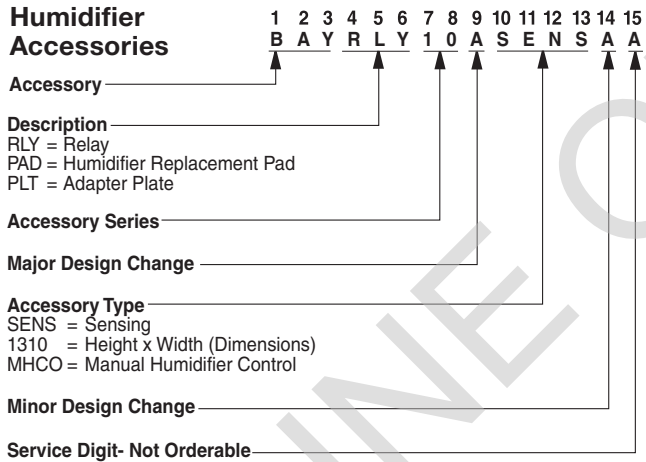
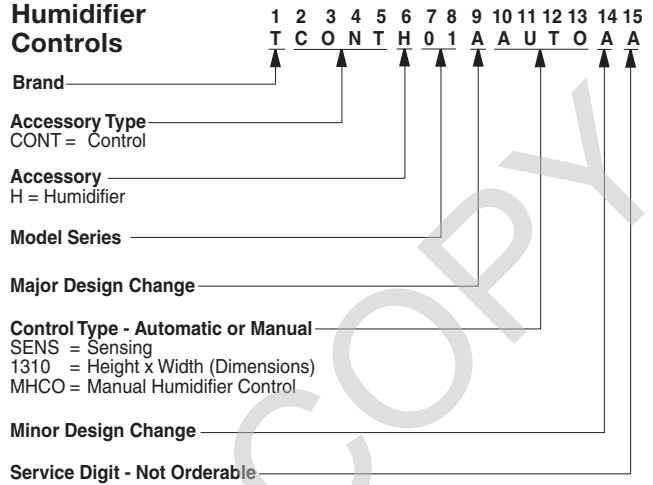
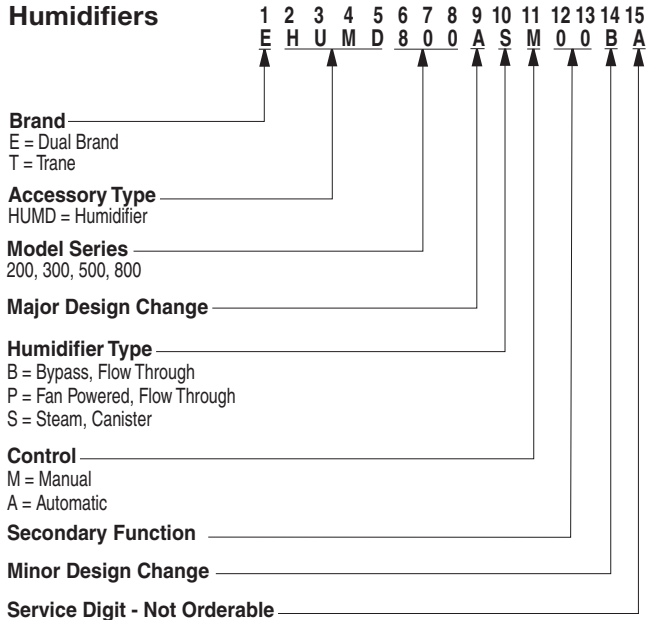



It's Hard To Stop A Trane.®

Model Nomenclature Residential

Packaged Units 15-Digit Model

1 2 3 4 5 6 7 8 9 10 11 12 13 14 15
4 Y C C 4 0 4 2 A 3 0 0 A A

- Refrigerant
4 = R-410A
- Type
Y = Gas Electric
W = Heat Pump
D = Dual Fuel
T = Air Conditioner
- Configuration
C = Convertible
H = Horizontal (only)
- Model Tier
C = Entry Level
Y = Premium
Z = Leadership - (2-Stage)
- Efficiency Tier
4 = 14.0 SEER / 13.4 SEER2
5 = 15.0 SEER2
6 = 16.0 SEER
- Capacity in 1000's (BTUH)
018 042
024 048
030 060
036
- Major Design Change
- Voltage & Phase
1 = 230V 1 Phase
3 = 230V 3 Phase
4 = 460V 3 Phase
- Gas Heat Input (MBTU/H)
000 (AC or HP) 075
- Minor Design Change
- Service Digit - Not Orderable

Packaged Units (Pre-410A Refrigerant)

1 2 3 4 5 6 7 8 9 10 11 12
Y C X 0 3 6 G 1 M 0 A 0

- Product Type
TC = Cooling, Electric Heat
WC = Heat Pump Packaged
YC = Gas Electric
DC = Heat Pump with Gas Heat
- Airflow Configuration
D = Downflow Y = Super High Efficiency
H, K = Horizontal Z = Ultra High Efficiency
C = Convertible
X = High Efficiency
- Cooling Capacity in 1000's (BTUH)
018 = 1 1/2 Tons 060 = 5 Tons
024 = 2 Tons 150 = 12 1/2 Tons
030 = 2 1/2 Tons 180 = 15 Tons
036 = 3 Tons 210 = 17 1/2 Tons
042 = 3 1/2 Tons 240 = 20 Tons
048 = 4 Tons 300 = 25 Tons
- Commercial High Efficiency Units
151 = 12 1/2 Tons
181 = 15 Tons
211 = 17 1/2 Tons
241 = 20 Tons
301 = 25 Tons
- Major Design Change
F = Impack - Side by Side - Ft. Smith Only
B = Over/Under - Ft. Smith Only
G = Impack Plus - Side by Side - Ft. Smith Only
- Electrical Characteristics
1 = 208-230/1/60
3 = 208-230/3/60
4 = 460/3/60
- Secondary Capacity And/Or Factory-Installed Options
OO = No Heat, No Options
LO = Low Heating Capacity
MO = Medium Heating Capacity
HO = High Heating Capacity
- Minor Design Change
- Service Digit - Not Orderable

ONLINE ONLY COPY



It's Hard To Stop A Trane.®

Model Nomenclature Residential

Controls

1 2 3 4 5 6 7 8 9 10 11 12 13 14 15
 T Z O N E 9 5 0 A C 5 2 Z A A

Brand ————
 T = Trane
 Z = Unbranded

Accessory Type ————
 CONT = Control (thermostat)
 ZONE = Control (zoning)

Model Series ————

Major Design Modifications ————

Control Platform ————
 M = Mechanical
 N = Non-programmable Electronic (Digital Display)
 F = Five/Two Programmable Electronic (Digital Display)
 S = Seven Day Programmable Electronic (Digital Display)
 C = Communicating
 W = Wireless

Heating Stages ————

Cooling Stages ————

Equipment Application ————
 A = AC / Heat (Gas or Electric)
 G = AC / Heat (Gas)
 E = AC / Heat (Electric)
 H = Heat Pump
 M = Multi-Application - AC / Heat (Gas/Elec) / Heat Pump
 D = Dual Fuel, Heat Pump, or AC and Heat (Gas/Elec)
 C = Communicating
 Z = Zoning - Universal application - 3 wire Communicating zone control of AC or Heat (Gas/Elec) and Dual Fuel Heat Pump
 U = Universal Application - Communicating Control of AC/Heat (Gas/Elec) / Dual Fuel Heat Pump

Minor Design Change ————

Service Digit ————

Zone Dampers

1 2 3 4 5 6 7 8 9 10 11 12 13 14 15
 Z D A M P R D M A 0 0 1 2 A A

Brand ————
 Z = Zoning

Damper ————

Model Series ————
 RD = Round
 RR = Retro-Fit Round
 SM = Side Mount Rectangular
 BM = Bottom Mount Rectangular

Modulating Damper (24 Volt, 60 Sec. Timing) ————

Major Design Modifications ————

Dimensions ————
 0012 = 12" Round
 1014 = 10" X 14" Rectangular (motor mounted on 2nd dimension)

Minor Design Change ————

Service Digit ————

ONLINE ONLY COPY



Trane® Link System Controller and Smart Thermostat



SC360
System controller



UX360
Smart thermostat

TLINK360A2VVUA

(kit includes System Controller and Smart Thermostat)

- Mobile app compatible with built-in Z-Wave bridge (download Trane Home mobile app)
- Trane Diagnostics ①
- Trane Diagnostics mobile app compatibility allows for easy technician commissioning and servicing
- WiFi connection
- Control from a smartphone, tablet, or computer ①②
- 7" diagonal color touchscreen
- 1-Touch Presets - Home, Away, Sleep
- 7 Day programmable with up to four schedules per day
- Smart Continuous Fan
- Adjustable Continuous Airflow (35-100%)
- Five day weather forecast ①
- Indoor relative humidity display
- Test modes and alert diagnostics
- Over-the-air Software Upgrade ①
- Color: Designer White
- Limited Warranty: 5 yr. base/10 yr.

Application:

- TruComfort™ Variable Speed
- Remote wired temperature sensor available through the hub
- Remote wireless indoor temperature and humidity sensor (optional): ZSENS930AW00MA

① Requires internet service and connection to Trane® Home Smart Home System.
② Trane® Home remote climate access is included with the purchase of up to 8 Connected Controls per home. Adding accessories to your Trane® Home system may require a monthly subscription for remote access via most web-enabled smartphones, tablets and computers.

For complete equipment / combination selections, installation instructions and warranty information, please refer to Product Data/Ratings and/or Installers Guides and Limited Warranty Handbooks.



It's Hard To Stop A Trane.®

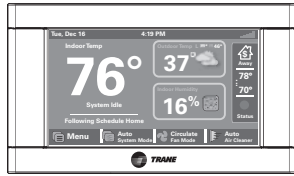

XL 824
TCONT824AS52DB



TCONT824AS52DB

- Energy Star® certified
- Built-in Z-Wave Bridge ①
- WiFi or Ethernet connection
- Control from a smartphone, tablet, or computer ①②
- 4.3" color touchscreen
- 7 Day programmable with up to four schedules per day
- Five day weather forecast, weather radar, and weather alerts ①
- Indoor relative humidity display
- Enhanced dehumidification (cooling)
- 2 Auxiliary dry contacts control 2 of the following: Whole house humidifier, dehumidifier, or ventilation system
- Test modes and alert diagnostics
- Screen access restrictions
- Trane Diagnostics ①
- Over-the-air software upgrade ①
- Local software upgrade option
- Silver/Gray color
- Limited Warranty: 5 yr. base/10 yr.

Application:

- Conventional gas/electric, heat pump, and dual fuel systems
- Conventional boiler systems (forced air only)
- Conventional HVAC systems:
 - 2 Heat / 2 cool
- Heat Pump systems: Up to 5 stages heat / 2 stages cool (2 compressor heat - 3 auxiliary heat / 2 cooling)
- Heat Pump switchover valve: selectable "with cool or with heat"
- Remote wired indoor temperature sensor (optional) ZZSENSAL0400AA
- Remote wireless indoor temperature and humidity sensor (optional): ZSENS930AW00MA
- Remote wired outdoor temperature sensor (optional) BAYSEN01ATEMPA
- PWM Circuit (BK terminal): controls indoor unit variable speed blower
- Wall cover plate BAYCOVR800A

Dimensions:

- Product: 5.43"w x 3.39"h x 1.30"d
- Display: 4.15"w x 2.65"h

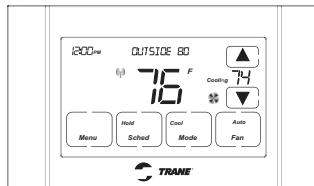

XL 724
TCONT724AS42DA



TCONT724AS42DA

- Mobile app compatible (Download Trane Home) ①②
- WiFi connectivity
- Control from a smartphone, tablet, or computer ①②
- Trane Diagnostics ①
- 4.3" diagonal black and white touchscreen
- 7 Day programmable with up to 4 schedules per day
- Humidity sensor and RH display
- Remote temperature sensor connections (1 indoor/1 outdoor)
- Auxiliary & compressor heat lockouts
- Auxiliary dry contact
- Enhanced dehumidification (cooling)
- PWM Circuit (BK terminal): control indoor unit variable speed blowers
- Energy Savings Mode (ESM)
- Screen lock and guest lock
- Service test modes
- Upgradable software
- Color: Designer Silver
- Limited Warranty: 1 yr. base/5 yr.

Application:

- Up to 4 Stages Heat/2 Stages Cool
- Conventional gas/electric, heat pump, and dual fuel systems
- Conventional boiler systems (baseboard & radiators)
- Remote wired indoor temperature sensor (optional): ZZSENSAL0400AA
- Remote wired outdoor temperature sensor (optional): BAYSEN01ATEMPA
- Wall cover plate BAYCOVR800A
- Z-Wave Bridge is required to control Z-Wave devices ①②

Dimensions:

- Product: 5.9"w x 3.47"h x .95"d
- Display: 3.8"w x 2.3"h

① Requires internet service and Trane® Home smart home system registration.

② Trane® Home remote climate access is included with the purchase for up to 8 Connected Controls per home. Adding accessories or additional controls to your Trane® Home system may require a monthly subscription.

For complete equipment / combination selections, installation instructions and warranty information, please refer to Product Data/Ratings and/or Installers Guides and Limited Warranty Handbooks.

ComfortLink™ II Communicating Smart Thermostat

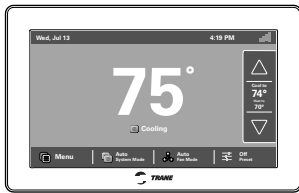

XL 1050
TZON1050AC52ZA

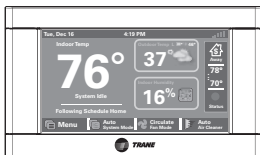

XL 850
TCONT850AC52UB



TZON1050AC52ZA

- Mobile app compatible with built-in
- Z-Wave bridge (download Trane Home mobile app)
- Trane Diagnostics ①
- WiFi or Ethernet connection
- Control from a smartphone, tablet, or computer ①②
- 7" diagonal color touchscreen
- 1-Touch Presets - Home, Away, Sleep
- 7 Day programmable with up to four schedules per day
- Customizable Home Screen
- Runtime History
- Allergy and Quick Clean Air Cycles
- Smart Continuous Fan
- Adjustable Continuous Airflow (35-100%)
- Screen access restrictions
- Dealer Contact Widget
- Service, Filter, Humidifier, UV Light, Air Cleaner Reminders
- Five day weather forecast, weather radar, and weather alerts ①
- Indoor relative humidity display
- Test modes and alert diagnostics
- Over-the-air Software Upgrade ①
- Local Software Upgrade option
- Color: Designer Silver
- Limited Warranty: 5 yr. base/10 yr.

Application:

- TruComfort™ Variable Speed
- ComfortLink™ II Two Stage Systems
- ComfortLink™ II Zoning Systems
- TruComfort™ Variable speed outdoor cooling or heat pump unit combined with S-Series noncommunicating variable speed furnace and "C" model Relay Panel
- Relay panel (BAY24VRP52DC) is required when applied with conventional systems (Gas Electric, Heat Pump, Dual Fuel, Boilers - forced air only)
- Relay Panel Supports:
 - Up to 5 stages heat, 2 stages cool
 - Connections for Remote indoor and outdoor temperature sensors
 - 3 Dry Auxiliary Contacts to control whole house humidifier, dehumidifier, or ventilation system
- Remote wired indoor temperature sensor (optional) ZZSENSAL0400AA
- Remote wireless indoor temperature and humidity sensor (optional): ZSENS930AW00MA
- Remote wired outdoor temperature sensor (optional) BAYSEN01ATEMPA

Dimensions:

- Product: 7.2"w x 4.5"h x 1.2"d
- Display: 6.1"w x 3.3"h

TCONT850AC52UB

- Mobile app compatible with built-in Z-Wave bridge (download Trane Home mobile app)
- WiFi or Ethernet connection
- Control from a smartphone, tablet, or computer ①②
- Trane Diagnostics ①
- 4.3" diagonal color touchscreen
- Compatible with ComfortLink™ II communicating systems (variable speed and two stage)
- Compatible with conventional 24 volt HVAC, heating, heat pump, and dual fuel systems when used with accessory relay panel model BAY24VRPAC52DC
- 7 Day programmable with up to four schedules per day
- Five day weather forecast, weather radar, and weather alerts ①
- Indoor relative humidity display
- Test modes and alert diagnostics
- Trane® Home Diagnostics ①
- Over-the-air software upgrades ①
- Local software upgrade option
- Silver/Gray color
- Wall cover plate BAYCOVR800A
- Limited Warranty: 5 yr. base/10 yr.

Application:

- ComfortLink™ II communicating systems (variable speed and two stage)
- Variable speed outdoor cooling combined with S-Series non-communicating variable speed furnace and "C" model Relay Panel
- Conventional gas/electric, heat pump, dual fuel systems, or boiler systems (forced air only) with use of relay panel model BAY24VRPAC52DB. Relay panel controls up to 5 stages heat, 2 stages cool, remote indoor and outdoor connections, humidifier, dehumidifier, and ventilation system.
- Remote wired indoor temperature sensor (optional) ZZSENSAL0400AA
- Remote wireless indoor temperature and humidity sensor (optional): ZSENS930AW00MA
- Remote wired outdoor temperature sensor (optional) BAYSEN01ATEMPA

Dimensions:

- Product: 5.43"w x 3.39"h x 1.30"d
- Display: 4.15"w x 2.65"h

① Requires internet service and connection to Trane® Home Smart Home System.
② Trane® Home remote climate access is included with the purchase of up to 8 Connected Controls per home. Adding accessories to your Trane® Home system may require a monthly subscription for remote access via most web-enabled smartphones, tablets and computers.

For complete equipment / combination selections, installation instructions and warranty information, please refer to Product Data/Ratings and/or Installers Guides and Limited Warranty Handbooks.



It's Hard To Stop A Trane.®

Trane® Home Compatible Products

Remote Temperature Sensor

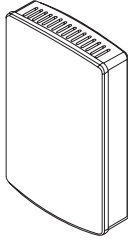

Remote Wireless Indoor Sensor

ZSENS930AW00MA

- Indoor Wireless Temperature and Humidity Sensor for use with TCONT824, TCONT850, TZON1050
- Operating Ambient Temperature Range: 32° to 104°F (0° to 40°C)
- Power Supply: Two AAA alkaline batteries
- Sensor Accuracy: +/-1°F over the sensing range of 32°F to 120°F (0° to 48.9°C)
- Operating Relative Humidity: 10% to 90% non-condensing
- Enables RoomIQ™ access in Trane Home mobile app

Dimensions in in. (mm):

- 2.0" (51)w x 3.25" (83)h x .6 (15)d
- Storage Temperature: -40° to 140°F (-40° to 65°C)
- Finish: White

Modules



Smart Energy Switch

Smart Energy Switch

SKU: 811097020464

- Z-Wave plus Smart Energy Switch with single switched outlet
- Can be scheduled or remote controlled via Trane Home app on smartphone/tablet
- Physical button allows manual switch control
- Built-in Z-Wave repeater to extend wireless range up to 250ft
- Monitors energy consumption of plugged-in device and provides instant power and accumulated power consumption reports via Trane Home app
- Plugs into any standard 120VAC outlet. Provides over voltage/current protection.
- For indoor use only

Application:

- Protocol: Z-Wave Plus
- Manufacturer: Trane Home
- Max load: 400W incandescent, 15A resistive, 120VAC
- Operating Temperature: 32-104°F

Unit Dimensions:

- 2.2"w x 2.2"d x 2.4"h
- Shipping weight: 1 lb.

Warranty

- 1-Year Limited Warranty

For complete equipment / combination selections, installation instructions and warranty information, please refer to Product Data/Ratings and/or Installers Guides and Limited Warranty Handbooks.

Trane® Home Compatible Products

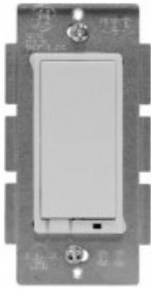

Jasco In-Wall Dimmer Switch

Dimmer Switch

SKU: 030878143219

SKU: 043180457127 (Phasing out)

- Turn light on/off or dim any incandescent lighting remotely from Trane® Home app ①
- Interchangeable paddles; white and light almond included in package (wall plate not included)
- Easy to install; includes space-saving screw terminals
- Automate with Trane® Home based on time of day
- Trigger actions from other smart products
- LED indicator glows in dark

Application:

- Protocol: Z-Wave Plus
- Power: 120 VAC, 60Hz
- Max Load: 1000W, 2-gang 800W and 3-gang 600W
- Operating Temperature: 0°C-40°C
- Indoor Use Only
- Specifications subject to change without notice

Warranty

- 1-Year Limited Warranty

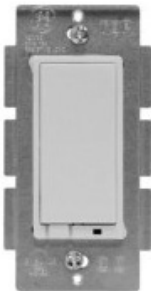

Jasco In-Wall On/Off Switch

On/Off Switch

SKU: 030878143189

- Turn any light on/off remotely from Trane® Home app ①
- Interchangeable paddles; white and light almond included in package (wall plate not included)
- Easy to install; includes space-saving screw terminals
- Automate with Trane® Home based on time of day
- Trigger actions from other smart products
- LED indicator glows in dark

Application:

- Protocol: Z-Wave Plus
- Power: 120 VAC, 60Hz
- Max Load: 960W Incandescent, 1/2 HP Motor, 1800W (15A) Resistive
- Operating Temperature: 0°C-40°C
- Indoor Use Only
- Specifications subject to change without notice

Warranty

- 1-Year Limited Warranty



Jasco In-Wall 3-Way Add-on Switch

3-Way Add-on Switch

SKU: 030878465601

- The Jasco Add-On Switch mirrors the functionality of the Jasco switch with which it is paired. Unlike traditional lighting controls, all paired switches perform the same functions. ①
- Compatible with all In-Wall GE and Jasco Switches, Dimmers and Fan Controls
- Required for use with 3- and 4-way wiring
- Interchangeable paddles; white and light almond included in package (wall plate not included)
- Easy to install; includes space-saving screw terminals

Application:

- Power: 120 VAC, 60Hz
- Operating Temperature: 0°C-40°C
- Indoor Use Only
- Specifications subject to change without notice

Warranty

- 1-Year Limited Warranty

For complete equipment / combination selections, installation instructions and warranty information, please refer to Product Data/Ratings and/or Installers Guides and Limited Warranty Handbooks.

① Requires internet service and Trane® Home smart home system registration.

Effective 1/1/23
22-8301-36



It's Hard To Stop A Trane.®

Trane® Home Compatible Products



Jasco In-Wall Fan Control Switch

In-Wall Fan Control Switch

SKU: 030878143141

SKU: 030878127301 (Phasing out)

- Turn fan on/off and control up to three speed levels remotely from Trane® Home app
- Interchangeable paddles; white and light almond included in package (wall plate not included)
- Easy to install; includes space-saving screw terminals and neutral jumper wires
- Automate with Trane® Home based on temperature (with Z-Wave temperature sensor) or time of day
- Trigger actions from other smart products
- LED indicator glows in dark

Application:

- Protocol: Z-Wave
- Power: 120 VAC, 60Hz
- Max Load: 1.5A no more than two identical fans per switch not to exceed 1.5A resistive load - Controls Fan Motor Only - for use with split capacitor or shaded pole ceiling fan motors
- Operating Temperature: 0°C-40°C
- Indoor Use Only
- Specifications subject to change without notice



JASCO In-Wall Smart Motion Switch

In-Wall Smart Motion Switch

SKU: 030878247702

- Indoor in-wall Z-Wave light switch with integrated motion sensor
- Wirelessly trigger scenes/automations and send alerts to smartphone or tablet when motion detection has turned lights on or off.
- Can be used in 3-way and 4-way applications
- Multiple Operation Modes:
 - Occupancy - auto ON/auto OFF
 - Vacancy - manual ON/auto OFF
 - Manual - manual ON/OFF
- 3 Sensitivity Levels - low, medium, high
- Requires in-wall installation with hard-wired connections - Neutral wire REQUIRED.
- Includes white and light almond paddles (wall plate not included)

Application:

- Protocol: Z-Wave
- Manufacturer: JASCO
- Max load: 960W incandescent, ½ HP motor, 1800W, 120VAC
- Operating Temperature: 32-104°F

Unit Dimensions:

- 1.5"w x 1.5"d x 3.0"h

Warranty

- 1-Year Limited Warranty

For complete equipment / combination selections, installation instructions and warranty information, please refer to Product Data/Ratings and/or Installers Guides and Limited Warranty Handbooks.

Security Sensors & Alarms

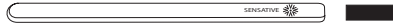

**Sensative Strips Door/
Window Sensor**

Sensative Strips Door/Window Sensor
SKU: 7350088520024

- Ultra thin design (less than 3 mm) for invisible mounting between most doors/windows and their frames
- Simple to set up with the included adhesive backing
- Indoor or outdoor use
- Not for use on metal surfaces which may block the signal
- Long lasting non-replaceable battery (10 year life)

Application:

- Protocol: Z-Wave
- Manufacturer: Sensative

Application:

- Indoor Range: 130 ft.
- Magnetic Range: 0.6"
- Operating Temperature: -4°F-140°F (-20°C-60°C)

Dimensions:

- Sensor: 7.7"l x 0.6"w x 0.12"d
- Magnet: 1.2"l x 0.43"w x 0.04"d
- Weight: 2 oz.

Warranty

- 1-Year Limited Warranty



Outdoor Lighting Module

Outdoor Lighting Module
SKU: 030878142847

- Wirelessly schedule and control outdoor lighting and appliances, including seasonal and landscape lighting, fountains and pumps from anywhere
- Contains one Z-Wave outlet and a manual switch for On/Off control
- Weather and impact resistant enclosure
- Built-in mounting bracket

Application:

- Protocol: Z-Wave
- Max load: 600W incandescent, ½ HP motor, 120VAC
- Operating Temperature: 32-104°F

Dimensions:

- 5.5"h x 4.0"w x 2.5"d

Warranty

- 1-Year Limited

For complete equipment / combination selections, installation instructions and warranty information, please refer to Product Data/Ratings and/or Installers Guides and Limited Warranty Handbooks.



Trane® Home Compatible Products

FortrezZ Water Valves

Indoor Actuator



Indoor Actuator
SKU: 045635411890

Indoor Actuator

- Remotely operated Z-Wave water valve compatible with Trane® Home smart home systems ①
- Automatically turns off main water supply when a water event is detected
- Select 3/4", 1", or 1-1/4" brass water valve for use with indoor actuator
- Can be used as irrigation device

- Multiple valves can be used and programmed in a Z-Wave Network
- Meets the standard of most state and municipal authorities
- Two tactile switches to manually activate the valve
- Ask insurance company for specific details about premium discounts for flood protection

Outdoor actuator



Outdoor Water Valve Variants
SKU: 661799563260

Outdoor actuator and indoor control with 50' cable ② ③

Brass Water Valves



Brass Ball Water Valves

SKU: 045635411852

3/4" Brass Valve ④

For complete equipment / combination selections, installation instructions and warranty information, please refer to Product Data/Ratings and/or Installers Guides and Limited Warranty Handbooks.

- ① Requires internet service and Trane® Home smart home system registration.
- ② Used with brass ball valves (ordered separately)
- ③ For applications that require outside installation above or below grade with temporary submersion at limited depth. See installation instructions for details.
- ④ Used with outdoor water valve variant (ordered separately)

TruComfort™ Variable Speed Cooling Single Phase – 2-5 Tons



XV20i
(Variable Speed)

Table SC-1-A – XV20i R-410A TruComfort™ Variable Speed Cooling (30–100% capacity)—with Trane Link®

Model Number	Power Supply	Nom. Cap. Cooling (BTUH)	Uncrated Dimensions (in.)			Shipping Weight (lbs.)	Sound** Rating	MCA*	Max. Fuse*	Line Size (in)	
			H	W	D					OD Gas	OD Liq.
4TTV0X24A1000A	208/230/1/60	24,000	46	33	30	228	66	17.0	25	3/4	3/8
4TTV0X36A1000A	208/230/1/60	36,000	47	37	34	263	70	18.0	25	3/4	3/8
4TTV0X48A1000A	208/230/1/60	48,000	47	37	34	285	74	23.0	35	7/8	3/8
4TTV0X60A1000A	208/230/1/60	54,000	51	37	34	299	75	27.0	40	7/8	3/8
4TTV0X61A1000A	208/230/1/60	54,000	51	37	34	329	75	27.0	40	7/8	3/8



XV18
(Variable Speed)

Table SC-1-B – XV18 R-410A TruComfort™ Variable Speed Cooling (30–100% capacity)—with Trane Link®

Model Number	Power Supply	Nom. Cap. Cooling (BTUH)	Uncrated Dimensions (in.)			Shipping Weight (lbs.)	Sound** Rating	MCA*	Max. Fuse*	Line Size (in)	
			H	W	D					OD Gas	OD Liq.
4TTV8X24A1000A	208/230/1/60	24,000	41	33	30	217	66	17.0	25	3/4	3/8
4TTV8X36A1000A	208/230/1/60	36,000	41	33	30	228	70	18.0	25	3/4	3/8
4TTV8X48A1000A	208/230/1/60	48,000	41	37	34	270	74	23.0	35	7/8	3/8
4TTV8X60A1000A	208/230/1/60	54,000	45	37	34	284	75	27.0	40	7/8	3/8

® Must use UX360 Smart Thermostat and SC360 System Control.

* Information subject to change. Please confirm with current Product Data/Service Facts for current factory production.

** Rated in accordance with AHRI Standard 270-2008 (Min/Max when applicable).

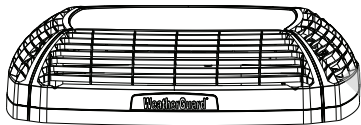

WEATHERGUARD™ TOP ACCESSORY

BAYTWGR0003 - Fits base sizes 33"x30" (WxD)

BAYTWGR0004 - Fits base sizes 37"x34" (WxD)

TruComfort™ Variable Speed Cooling Single Phase – 2-5 Tons

Split System Cooling

Table SC-2-A — Features

	XV20i (4TTV0)	XV18 (4TTV8)
• SEER2 up to	21.50	18.00
• Climatuff™ compressor.....	1	1
• Number of stages	Variable	Variable
• Comfort-R™ mode approved	✓	✓
• Trane Link system.....	✓	✓
• DuraTuff™ base, fast complete drain, weatherproof	✓	✓
• Quick-Sess™ cabinet, service access & refrigerant connections with full coil protection	✓	✓
• Spine Fin™ coil	✓	✓
• Weatherguard™ II top.....	✓	—
• Compressor sound enclosure	✓	✓
• Compressor sump heat	✓	✓
• Factory supplied charge.....	R-410A	R-410A
• Glossy corrosion resistant finish.....	✓	✓
• High pressure switch	✓	✓
• Low pressure switch	✓	✓
• Internal high / low pressure & temperature protection	✓	✓
• Liquid line filter drier - factory installed or factory supplied for field install	✓	✓
• Seacoast shield - factory installed.....	✓	—
• Tarpaulin gray cabinet	✓	✓
• 12-year registered limited warranty on compressor, 10-year on outdoor coil & all other functional parts (Residential Use)*.....	✓	✓
• Extended warranties available.....	✓	✓

* Registered Limited Warranty terms are available when you register within 60 days of installation. You can register online at Trane.com or by phone at 855-260-2975, otherwise Trane's Base Limited Warranty terms will apply. Base Limited Warranty information on specific products can be found on ComfortSite.com.

Table SC-2-B — Optional Accessories

Model Number	Description	Shipping Weight		
BAYECMT023	Extreme Conditions Mounting Kit (Base 2/3)	2	2	2-3
BAYECMT004	Extreme Conditions Mounting Kit (Base 4)	2	3-5	048-60
BAYISLT101	Rubber Isolators	1	✓	✓
BAYVEN002	Enhanced Sound Enclosure	2	✓	✓
BAYLEGS007	Snow Legs - 7" High (Black)	1	✓	✓
BAYLEGS004	Snow Legs - 4" High (Black)	1	✓	✓
BAYVDTA003	Vertical Discharge Air Kit Base 3	10	2	—
BAYVDTA004	Vertical Discharge Air Kit Base 4	10	3-5	—
BAYSEAC001	Seacoast Kit	1	—	✓
PAI00309①	Heresite Spraypaint	1	✓	✓
BAYSEN01ATEMPA	External Ambient Kit		✓	✓
BAYTWGR0004	WEATHERGUARD™ Top - Fits unit base size of (W x D) of 37" X 34"		—	048-060
BAYTWGR0003	WEATHERGUARD™ Top - Fits unit base size of (W x D) of 33" X 30"		—	024-036
BAYECC001	Extreme Coastal Conditions Kit*		✓	✓
BAYCAKT002	SmartCharge™ automatic charging solenoid kit.....		✓	✓

* Not for use in Arizona or other extreme heat applications.†

Comfort Controls — See Comfort Controls/Zone Sensors Section

① Used for additional seacoast corrosion protection. Refer to bulletin number UN-SVB11A-EN for application information.

Split System Cooling Single Phase – 1½-5 Tons



XL17i
(Two Stage)

Table SC-3-A – XL17i R-410A Split System Two Stage Cooling (70/100% capacity)

Model Number	Power Supply	Nom. Cap. Cooling (BTUH)	Uncrated Dimensions (in.)			Shipping Weight (lbs.)	Sound** Rating	MCA*	Max. Fuse*	Line Size (in)	
			H	W	D					OD Gas	OD Liq.
4TTX7024E1000A	208/230/1/60	24,000	47	37	34	313	72	13.4	20	¾	⅜
4TTX7036E1000A	208/230/1/60	36,000	51	37	34	321	72	18.4	30	¾	⅜
4TTX7048E1000A	208/230/1/60	48,000	51	37	34	336	73	28.0	45	¾	⅜
4TTX7060E1000A	208/230/1/60	54,000	51	37	34	332	74	35.0	60	7/8	⅜



XL15i
(Single Stage)

Table SC-3-B – XL15i R-410A Split System Single Stage Cooling

Model Number	Power Supply	Nom. Cap. Cooling (BTUH)	Uncrated Dimensions (in.)			Shipping Weight (lbs.)	Sound** Rating	MCA*	Max. Fuse*	Line Size (in)	
			H	W	D					OD Gas	OD Liq.
4TTX5018N1000A	208/230/1/60	18,000	35	33	30	200	73	12.0	20	¾	⅜
4TTX5024N1000A	208/230/1/60	24,000	35	33	30	201	73	13.0	20	¾	⅜
4TTX5030N1000A	208/230/1/60	30,000	42	33	30	231	73	17.0	25	¾	⅜
4TTX5036N1000A	208/230/1/60	36,000	43	37	34	255	71	18.0	30	¾	⅜
4TTX5042N1000A	208/230/1/60	42,000	51	37	34	327	72	21.0	35	¾	⅜
4TTX5048N1000A	208/230/1/60	48,000	51	37	34	331	72	24.0	40	7/8	⅜
4TTX5060N1000A	208/230/1/60	54,000	51	37	34	331	71	28.0	50	1 1/8	⅜

* Information subject to change. Please confirm with current Product Data/Service Facts for current factory production.

** Rated in accordance with AHRI Standard 270-2008 (Min/Max when applicable).

Split System Cooling Single Phase – 1½-5 Tons

Table SC-4-A – Features

	XL17i (4TTX7)	XL15i (4TTX5)
• SEER2 up to	17.20	15.60
• Climatuff™ compressor.....	1	1
• Number of stages	2	1
• Comfort-R™ mode approved	✓	✓
• DuraTuff™ base, fast complete drain, weatherproof	✓	✓
• Quick-Sess™ cabinet, service access & refrigerant connections with full coil protection	✓	✓
• Spine Fin™ coil	✓	✓
• Weatherguard™ II top.....	✓	✓
• Factory supplied charge.....	R-410A	R-410A
• Glossy corrosion resistant finish.....	✓	✓
• High pressure switch	✓	✓
• Low pressure switch	✓	✓
• Internal high / low pressure & temperature protection	✓	✓
• Liquid line filter drier - factory installed or factory supplied for field install	✓	✓
• Start kit-factory installed.....	—	1½-2
• Seacoast shield - factory installed.....	✓	✓
• Tarpaulin gray cabinet	✓	✓
• 12-year registered limited warranty on compressor, 10-year on outdoor coil & all other functional parts (Residential Use)*.....	✓	✓
• Extended warranties available.....	✓	✓

* Registered Limited Warranty terms are available when you register within 60 days of installation. You can register online at Trane.com or by phone at 855-260-2975, otherwise Trane's Base Limited Warranty terms will apply. Base Limited Warranty information on specific products can be found on ComfortSite.com.

Table SC-4-B – Optional Accessories

Model Number	Description	Shipping Weight		
AY28X079.....	Evap. Defrost Control Kit.....	1.....	✓	—
BAYCCHT301RES	Crankcase Heater Kit (Scroll)	1.....	4-5	3½-5
BAYCCHT302RES	Crankcase Heater Kit (Scroll)	1.....	2-3	1½-3
BAYECMT003	Extreme Conditions Mounting Kit (Base 3)	2.....	—	1½-2½
BAYECMT004	Extreme Conditions Mounting Kit (Base 4)	2.....	✓	3-5
BAYISLT101	Rubber Isolators	1.....	✓	✓
BAYKSKT263.....	Start kit.....	1.....	2-3	2½-5
BAYKSKT266.....	Start kit.....	1.....	4-5	—
BAYLEGS007.....	Snow Legs - 7" High (Black)	1.....	✓	✓
BAYLEGS004.....	Snow Legs - 4" High (Black)	1.....	✓	✓
BAYLOAM107A	Low Ambient Kit	1.....	✓	✓
BAYVDTA003	Vertical Discharge Air Kit Base 3	10.....	—	1½-2½
BAYVDTA004	Vertical Discharge Air Kit Base 4	10.....	✓	3-5
TAYASCT501A①②	Anti-Short Cycle Timer	2.....	✓	✓
PAI00309③.....	Heresite Spraypaint	1.....	✓	✓

Comfort Controls – See Comfort Controls/Zone Sensors Section

- ① Not for use with programmable thermostats.
- ② Activated on Power Off.
- ③ Used for additional seacoast corrosion protection. Refer to bulletin number UN-SVB11A-EN for application information.

Split System Cooling Single Phase – 1½-5 Tons

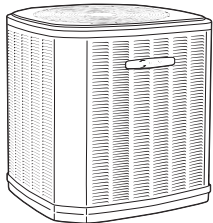

**XR16
(Two Stage)**

Table SC-5-A – XR16 R-410A Split System Two Stage Cooling (70/100% capacity)

Model Number	Power Supply	Nom. Cap. Cooling (BTUH)	Uncrated Dimensions (in.)			Shipping Weight (lbs.)	Sound** Rating	MCA*	Max. Fuse*	Line Size (in)	
			H	W	D					OD Gas	OD Liq.
4TTR6024N1000A	208/230/1/60	24,000	41	37	34	280	72	13.4	20	3/4	3/8
4TTR6036N1000A	208/230/1/60	36,000	45	37	34	288	72	18.4	30	3/4	3/8
4TTR6048N1000A	208/230/1/60	48,000	45	37	34	296	73	28.0	45	7/8	3/8
4TTR6060N1000A	208/230/1/60	54,000	45	37	34	312	74	35.0	60	1 1/8	3/8

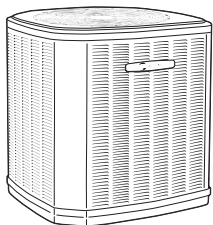

**XR15
(Single Stage)**

Table SC-5-B – XR15 R-410A Split System Single Stage Cooling

Model Number	Power Supply	Nom. Cap. Cooling (BTUH)	Uncrated Dimensions (in.)			Shipping Weight (lbs.)	Sound** Rating	MCA*	Max. Fuse*	Line Size (in)	
			H	W	D					OD Gas	OD Liq.
4TTR5018N1000A	208/230/1/60	18,000	29	33	30	189	73	12.0	20	3/4	3/8
4TTR5024N1000A	208/230/1/60	24,000	29	33	30	190	73	13.0	20	3/4	3/8
4TTR5030N1000A	208/230/1/60	30,000	37	33	30	220	73	17.0	25	3/4	3/8
4TTR5036N1000A	208/230/1/60	36,000	37	37	34	246	71	18.0	30	7/8	3/8
4TTR5042N1000A	208/230/1/60	42,000	45	37	34	302	72	21.0	35	7/8	3/8
4TTR5048N1000A	208/230/1/60	48,000	45	37	34	306	72	24.0	40	7/8	3/8
4TTR5060N1000A	208/230/1/60	54,000	45	37	34	306	71	28.0	50	7/8	3/8

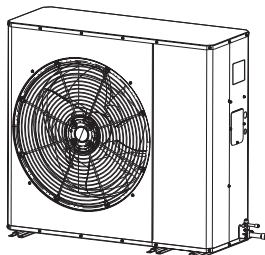

**XR15
(Single Stage)**

Table SC-5-C – XR15 R-410A Side Discharge Single Stage Cooling

Model Number	Power Supply	Nom. Cap. Cooling (BTUH)	Uncrated Dimensions (in.)			Shipping Weight (lbs.)	Sound** Rating	MCA*	Max. Fuse*	Line Size (in)	
			H	W	D					OD Gas	OD Liq.
4TTL5024N1000A①	208/230/1/60	24,000	37	47	18	224	70	15.0	25	3/4	3/8
4TTL5030N1000A①	208/230/1/60	30,000	37	47	18	224	70	15.0	25	3/4	3/8
4TTL5036N1000A①	208/230/1/60	36,000	37	47	18	226	72	17.0	30	7/8	3/8
4TTL5042N1000A①	208/230/1/60	42,000	43	47	18	266	74	24.0	40	7/8	3/8
4TTL5048N1000A①	208/230/1/60	48,000	43	47	18	266	74	24.0	40	7/8	3/8

① For coastal applications where units are installed within one (1) mile of salt water, epoxy coated models are available for order. Model numbers with "COT" in the eleventh (11) through thirteenth (13) digits represent an epoxy coated coil. Example: 4TTL6036A1COTA

These models have an 8 week lead time after order.

* Information subject to change. Please confirm with current Product Data/Service Facts for current factory production.

** Rated in accordance with AHRI Standard 270-2008 (Min/Max when applicable).



It's Hard To Stop A Trane.®

Split System Cooling Single Phase – 1½-5 Tons

Split System Cooling

Table SC-6-A – Features

	XR16 (4TTR6)	XR15 (4TTR5)	XR15 (4TTL5)
• SEER2 up to	16.20	15.60	15.60
• Climatuff™ compressor.....	✓	✓	✓
• Number of stages	2	1	1
• Comfort-R™ mode approved	✓	✓	✓
• DuraTuff™ base, fast complete drain, weatherproof.....	✓	✓	—
• Quick-Sess™ cabinet, service access.....	✓	—	—
• Spine Fin™ coil	✓	✓	—
• Copper Tube, Aluminum Fin coil.....	—	—	✓
• Factory supplied charge	R-410A	R-410A	R-410A
• Glossy corrosion resistant finish.....	✓	✓	✓
• High pressure switch	✓	✓	✓
• Internal high / low pressure & temperature protection	✓	✓	✓
• Liquid line filter drier - factory installed or factory supplied for field install	✓	✓	✓
• Quick start kit-factory installed.....	—	1½-2	—
• Tarpaulin gray cabinet	✓	✓	✓
• 10-year registered limited warranty on compressor, 10-year on outdoor coil & all other functional parts (Residential Use)*	✓	✓	✓
• Extended warranties available.....	✓	✓	✓

* Registered Limited Warranty terms are available when you register within 60 days of installation. You can register online at Trane.com or by phone at 855-260-2975, otherwise Trane's Base Limited Warranty terms will apply. Base Limited Warranty information on specific products can be found on ComfortSite.com.

Table SC-6-B – Optional Accessories

Model Number	Description	Shipping Weight	XR16 (4TTR6)	XR15 (4TTR5)	XR15 (4TTL5)
AY28X079.....	Evap. Defrost Control Kit	1	✓	✓	✓
BAYCCHT301RES.....	Crankcase Heater Kit (Scroll)	1	4-5	3½-5	3½-5
BAYCCHT302RES.....	Crankcase Heater Kit (Scroll)	1	2-3	1½-3	1½-3
BAYECMT023.....	Extreme Conditions Mounting Kit (Base 2/3)	2	✓	1½-2½	—
BAYECMT004.....	Extreme Conditions Mounting Kit (Base 4)	2	✓	3-5	—
BAYISLT101.....	Rubber Isolators.....	1	✓	✓	✓
BAYKSKT263.....	Start Kit.....	1	2-3	2½-5	2½-5
BAYKSKT266.....	Start Kit.....	1	4-5	—	—
BAYLEGS007.....	Snow Legs - 7" High (Black).....	1	✓	✓	✓
BAYLEGS004.....	Snow Legs - 4" High (Black).....	1	✓	✓	✓
BAYLOAM107A.....	Low Ambient Kit.....	1	✓	✓	✓
BAYSDEN001.....	Small Scroll Compressor Enclosures.....	8	—	1½-2	—
BAYSDEN004.....	Large Scroll Compressor Enclosures.....	8	—	2½-5	1½-5
BAYSEAC001.....	Seacoast Kit	1	✓	✓	—
BAYWIND100.....	Wind Baffle	—	—	—	1½-2½
BAYWIND101.....	Wind Baffle	—	—	—	3-5
TAYASCT501A①②.....	Anti-Short Cycle Timer.....	2	✓	✓	—
TAYSVPANL0032AA.....	Service Valve Panel Cover Kit	2	—	1½-2	—
TAYSVPANL3343AA.....	Service Valve Panel Cover Kit	2	2	—	—
TAYSVPANL0044AA.....	Service Valve Panel Cover Kit	2	3-5	2½-3	—
TAYSVPANL0046AA.....	Service Valve Panel Cover Kit	2	—	3½-5	—
PAI00309③.....	Heresite Spraypaint.....	1	✓	✓	✓
TAYASCT501A①②.....	Anti-Short Cycle Timer.....	—	1½	2-2½	✓
PAI00309③.....	Heresite Spraypaint.....	—	3-3½	4-5	✓
BRK05033④.....	Wall Mount Kit	—	—	—	✓
BAYTWGR0004.....	WEATHERGUARD™ Top - Fits unit base size of (W x D) of 37" X 34".....	—	✓	036-061	—
BAYTWGR0004.....	WEATHERGUARD™ Top - Fits unit base size of (W x D) of 33" X 30".....	—	—	018-030	—
BAYSDHG001A.....	Hail Guard Kit 3.2	—	—	—	✓
BAYSDHG002A.....	Hail Guard Kit 3.3	—	—	—	✓
BAYSDHG003A.....	Hail Guard Kit 4.3	—	—	—	✓
BAYSDHG004A.....	Hail Guard Kit 4.4	—	—	—	✓

A = Factory Installed

Comfort Controls – See Comfort Controls/Zone Sensors Section

- ① Do not use with programmable thermostats.
- ② Activated on Power Off.
- ③ Used for additional seacoast corrosion protection. Refer to bulletin number UN-SVB11A-EN for application information.
- ④ Available from Trane Parts.

For complete equipment / combination selections, installation instructions and warranty information, please refer to Product Data/Ratings and/or Installers Guides and Limited Warranty Handbooks.

Split System Cooling Single Phase – 1½-5 Tons

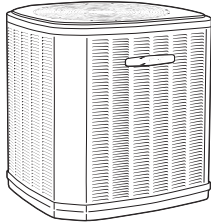

XR14
(Single Stage)

Table SC-7-A – XR14 R-410A Split System Single Stage Cooling

Model Number	Power Supply	Nom. Cap. Cooling (BTUH)	Uncrated Dimensions (in.)			Shipping Weight (lbs.)	Sound** Rating	MCA*	Max. Fuse*	Line Size (in)	
			H	W	D					OD Gas	OD Liq.
4TTR4018N1000A	208/230/1/60	18,000	29	29	26	153	71	14.0	20	3/4	3/8
4TTR4019N1000A	208/230/1/60	18,000	29	33	30	189	73	12.0	20	3/4	3/8
4TTR4024N1000AⓈ	208/230/1/60	24,000	29	29	26	153	71	18.0	30	3/4	3/8
4TTR4025N1000A	208/230/1/60	24,000	29	33	30	190	73	13.0	20	3/4	3/8
4TTR4030N1000AⓈ	208/230/1/60	30,000	33	33	30	183	71	16.0	25	3/4	3/8
4TTR4036N1000AⓈ	208/230/1/60	36,000	33	33	30	183	71	16.0	25	3/4	3/8
4TTR4042N1000AⓈ	208/230/1/60	42,000	37	37	34	246	72	20.0	35	7/8	3/8
4TTR4048N1000A	208/230/1/60	48,000	29	37	34	221	71	24.0	40	7/8	3/8
4TTR4049N1000A	208/230/1/60	48,000	45	37	34	306	72	24.0	40	7/8	3/8
4TTR4060N1000A	208/230/1/60	54,000	45	37	34	306	72	34.0	60	7/8	3/8

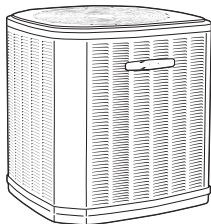

XR13
(Single Stage)

Table SC-7-B – XR13 R-410A Split System Single Stage Cooling

Model Number	Power Supply	Nom. Cap. Cooling (BTUH)	Uncrated Dimensions (in.)			Shipping Weight (lbs.)	Sound** Rating	MCA*	Max. Fuse*	Line Size (in)	
			H	W	D					OD Gas	OD Liq.
4TTR3018N1000AⓈ	208/230/1/60	18,000	29	29	26	153	71	12.0	20	3/4	3/8
4TTR3024N1000AⓈ	208/230/1/60	24,000	29	29	26	153	71	14.0	20	3/4	3/8
4TTR3030N1000AⓈ	208/230/1/60	30,000	29	33	30	183	71	17.0	25	3/4	3/8
4TTR3036N1000AⓈ	208/230/1/60	36,000	29	33	30	189	71	16.0	25	3/4	3/8
4TTR3042N1000AⓈ	208/230/1/60	42,000	29	37	34	216	71	22.0	35	7/8	3/8
4TTR3048N1000AⓈ	208/230/1/60	48,000	29	37	34	221	71	24.0	40	7/8	3/8
4TTR3060N1000AⓈ	208/230/1/60	54,000	37	37	34	246	71	27.0	45	7/8	3/8

Ⓢ Models are not legal for installation in California, Nevada, New Mexico and Arizona. All other models are legal for installation in all US zones and states.

Ⓢ 13.8 SEER2 AC equipment manufactured after 1/1/16 can only be installed in the North Zone.

* Information subject to change. Please confirm with current Product Data/Service Facts for current factory production.

** Rated in accordance with AHRI Standard 270-2008 (Min/Max when applicable).



It's Hard To Stop A Trane.®

Split System Cooling Single Phase – 1½-5 Tons

Split System Cooling

Table SC-8-A – Features

	XR14 (4TTR4)	XR13 (4TTR3)
• SEER2 up to	14.80	13.80
• Climatuff™ compressor.....	✓	✓
• Number of stages.....	1	1
• Comfort-R™ mode approved	✓	✓
• DuraTuff™ base, fast complete drain, weatherproof.....	✓	✓
• Quick-Sess™ cabinet, service access & refrigerant connections with full coil protection	✓	✓
• Spine Fin™ coil	✓	✓
• Factory supplied charge.....	R-410A	R-410A
• Glossy corrosion resistant finish.....	✓	✓
• High pressure switch	✓	✓
• Internal high / low pressure & temperature protection	✓	✓
• Liquid line filter drier - factory installed or factory supplied for field install	✓	✓
• Tarpaulin gray cabinet	✓	✓
• 10-year registered limited warranty on compressor, outdoor coil & all other functional parts (Residential Use)*	✓	✓
• Extended warranties available.....	✓	✓

* Registered Limited Warranty terms are available when you register within 60 days of installation. You can register online at Trane.com or by phone at 855-260-2975, otherwise Trane's Base Limited Warranty terms will apply. Base Limited Warranty information on specific products can be found on ComfortSite.com.

Table SC-8-B – Optional Accessories

Model Number	Description	Shipping Weight		
AY28X079	Evap. Defrost Control Kit	1	✓	✓
BAYCCHT301RES.....	Crankcase Heater Kit (Scroll).....	1	3½-5	3½-5
BAYCCHT302RES.....	Crankcase Heater Kit (Scroll).....	1	1½-3	1½-3
BAYECMT023.....	Extreme Conditions Mounting Kit (Base 2/3).....	2	1½-3	1½-4
BAYECMT004.....	Extreme Conditions Mounting Kit (Base 4).....	2	3½-5	43,49,60
BAYISLT101	Rubber Isolators.....	1	✓	✓
BAYKSKT263.....	Start Kit.....	1	2½-5	2-5
BAYLEGS007.....	Snow Legs - 7" High (Black).....	1	✓	✓
BAYLEGS004.....	Snow Legs - 4" High (Black).....	1	✓	✓
BAYLOAM107A.....	Low Ambient Kit.....	1	✓	✓
BAYSDEN001	Small Scroll Compressor Enclosures.....	8	1½-2½, 3½-4	1½-3½, 3049
BAYSDEN004	Large Scroll Compressor Enclosures.....	8	3, 5	3048, 5
BAYSEAC001	Seacoast Kit.....	1	✓	✓
TAYASCT501A①②.....	Anti-Short Cycle Timer	2	✓	✓
TAYSVPANL0022AA.....	Service Valve Panel Cover Kit	2	1½-2	1½-2½
TAYSVPANL0032AA.....	Service Valve Panel Cover Kit	2	2½,3½,4	3-4
TAYSVPANL3343AA.....	Service Valve Panel Cover Kit	2	3	—
TAYSVPANL0044AA.....	Service Valve Panel Cover Kit	2	5	5
PAI00309③	Heresite Spraypaint.....	1	✓	✓
BAYTWGR0004.....	WEATHERGUARD™ Top - Fits unit base size of (W x D) of 37" X 34".....		042-060	43, 49, 60
BAYTWGR0003.....	WEATHERGUARD™ Top - Fits unit base size of (W x D) of 33" X 30".....		030-037	36, 42, 48

Comfort Controls — See Comfort Controls/Zone Sensors Section

- ① Not for use with programmable thermostats.
- ② Activated on Power Off.
- ③ Used for additional seacoast corrosion protection. Refer to bulletin number UN-SVB11A-EN for application information.

For complete equipment / combination selections, installation instructions and warranty information, please refer to Product Data/Ratings and/or Installers Guides and Limited Warranty Handbooks.

Split System Cooling Three-Phase

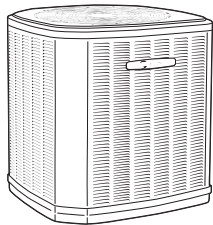

XR17
(Two Stage)

Table SC-9-A — XR17 R-410A Split System Two Stage Cooling — Three Phase

Model Number	Power Supply	Nom. Cap. Cooling (BTUH)	Uncrated Dimensions (in.)			Shipping Weight (lbs.)	Sound** Rating	MCA*	Max. Fuse*	Line Size (in)	
			H	W	D					OD Gas	OD Liq.
4TTA7036A3000A	208/230/3/60	36,000	45	37	34	283	72	15.0	25	3/4	3/8
4TTA7048A3000A	208/230/3/60	48,000	45	37	34	285	73	18.0	30	7/8	3/8
4TTA7060A3000A	208/230/3/60	54,000	45	37	34	308	74	22.0	35	7/8	3/8
4TTA7036A4000A	460/3/60	36,000	45	37	34	283	72	8.0	15	3/4	3/8
4TTA7048A4000A	460/3/60	48,000	45	37	34	285	73	9.0	15	7/8	3/8
4TTA7060A4000A	460/3/60	54,000	45	37	34	308	74	10.0	15	7/8	3/8

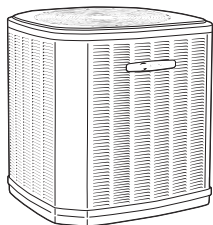

XR14
(Single Stage)

Table SC-9-B — XR14 R-410A Split System Single Stage Cooling — Three Phase

Model Number	Power Supply	Nom. Cap. Cooling (BTUH)	Uncrated Dimensions (in.)			Shipping Weight (lbs.)	Sound** Rating	MCA*	Max. Fuse*	Line Size (in)	
			H	W	D					OD Gas	OD Liq.
4TTA4036A3000A	208/230/3/60	36,000	33	33	30	183	73	12.0	20	3/4	3/8
4TTA4042A3000A	208/230/3/60	42,000	29	37	34	216	72	15.0	25	3/4	3/8
4TTA4048A3000A	208/230/3/60	48,000	29	37	34	221	72	18.0	30	7/8	3/8
4TTA4060A3000A	208/230/3/60	54,000	37	37	34	246	72	21.0	35	7/8	3/8
4TTA4036A4000A	460/3/60	36,000	33	33	30	183	73	8.0	15	3/4	3/8
4TTA4042A4000A	460/3/60	42,000	29	37	34	216	72	8.0	15	3/4	3/8
4TTA4048A4000A	460/3/60	48,000	29	37	34	221	72	8.0	15	7/8	3/8
4TTA4060A4000A	460/3/60	54,000	37	37	34	246	72	9.0	15	7/8	3/8

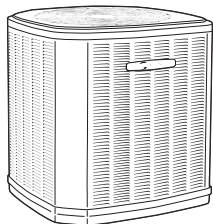

XR13
(Single Stage)

Table SC-9-C — XR13 R-410A Split System Single Stage Cooling — Three Phase

Model Number	Power Supply	Nom. Cap. Cooling (BTUH)	Uncrated Dimensions (in.)			Shipping Weight (lbs.)	Sound** Rating	MCA*	Max. Fuse*	Line Size (in)	
			H	W	D					OD Gas	OD Liq.
4TTA3036B3000B	208/230/3/60	36,000	29	33	30	176	78	13.6	20	3/4	3/8
4TTA3042D3000D	208/230/3/60	42,000	29	37	34	228	74	18.0	30	3/4	3/8
4TTA3048D3000D	208/230/3/60	48,000	29	37	34	235	75	18.0	30	7/8	3/8
4TTA3060D3000D	208/230/3/60	54,000	37	37	34	261	75	20.0	35	7/8	3/8
4TTA3036B4000B	460/3/60	36,000	29	33	30	176	78	7.7	15	3/4	3/8
4TTA3042D4000D	460/3/60	42,000	29	37	34	228	79	8.2	15	3/4	3/8
4TTA3048D4000D	460/3/60	48,000	29	37	34	235	79	8.4	15	7/8	3/8
4TTA3060D4000D	460/3/60	54,000	37	37	34	261	80	10.3	15	7/8	3/8

Split System Cooling

Split System Cooling Three-Phase

Table SC-10-A – Features

	XR17 (4TTA7)	XR14 (4TTA4)	XR13 (4TTA3)
• SEER up to	18.00	16.50	14.50
• Comfort-R™ mode approved	✓	✓	✓
• Climatuff™ compressor.....	✓	✓	✓
• DuraTuff™ base, fast complete drain, weatherproof.....	✓	✓	✓
• Quick-Sess™ cabinet, service access & refrigerant connections with full coil protection	✓	✓	✓
• Spine Fin™ coil	✓	✓	✓
• Copper Tubing, Aluminum Fin coil	—	—	—
• Compressor sump heat - factory installed	✓	✓	✓
• Refrigerant (not factory supplied)	R-410A	R-410A	R-410A
• Glossy corrosion resistant finish.....	✓	✓	✓
• High pressure switch	✓	✓	✓
• Compressor sound enclosure	—	—	3½
• Internal high / low pressure & temperature protection	✓	✓	✓
• Liquid line filter drier - factory installed or factory supplied for field install	✓	✓	✓
• Tarpaulin gray cabinet	✓	✓	✓
• 5-year basic limited warranty on compressor, 1-year on outdoor coil & all other functional parts (Commercial Use)	✓	✓	✓
• 10-year registered limited warranty on compressor, outdoor coil & all other functional parts (Residential Use)*	✓	✓	✓
• Extended warranties available.....	✓	✓	✓

* Registered Limited Warranty terms are available when you register within 60 days of installation. You can register online at Trane.com or by phone at 855-260-2975, otherwise Trane's Base Limited Warranty terms will apply. Base Limited Warranty information on specific products can be found on ComfortSite.com.

Table SC-10-B – Optional Accessories

Model Number	Description	Shipping Weight			
AY28X079.....	Evap. Defrost Control Kit	1.....	✓	✓	✓
BAYCCHT301RES.....	Crankcase Heater Kit (Scroll)	1.....	—	—	—
BAYCCHT302RES.....	Crankcase Heater Kit (Scroll)	1.....	—	—	—
BAYECMT023.....	Extreme Conditions Mounting Kit (Base 2/3)	2.....	—	3	2½-3
BAYECMT004.....	Extreme Conditions Mounting Kit (Base 4)	2.....	3-5	3½-5	3½-5
BAYISLT101.....	Rubber Isolators.....	1.....	✓	✓	✓
BAYKSKT263.....	Start Kit.....	1.....	✓	—	5
BAYKSKT260.....	Start Kit.....	1.....	✓	—	3
BAYLEGS007.....	Snow Legs - 7" High (Black).....	1.....	✓	✓	✓
BAYLEGS004.....	Snow Legs - 4" High (Black).....	1.....	✓	✓	✓
BAYLOAM107A.....	Low Ambient Kit.....	1.....	✓	✓	✓
BAYSDEN001.....	Single Cylinder Compressor Enclosures	8.....	—	3½-4	3-4
BAYSDEN004.....	Large Scroll Compressor Enclosures	8.....	✓	3, 5	5
BAYSEAC001.....	Seacoast Kit	1.....	✓	✓	✓
BAYWIND101.....	Wind Baffle.....	1.....	—	—	—
TAYASCT501A①②.....	Anti-Short Cycle Timer.....	2.....	✓	✓	✓
TAYSVPANL0032AA.....	Service Valve Panel Cover Kit	2.....	—	3½-4	3-4
TAYSVPANL3343AA.....	Service Valve Panel Cover Kit	2.....	—	3	2½
TAYSVPANL0044AA.....	Service Valve Panel Cover Kit	2.....	—	5	5
TAYSVPANL0046AA.....	Service Valve Panel Cover Kit	2.....	3-5	—	—
PAI00309③.....	Heresite Spraypaint.....	1.....	✓	✓	✓
BRK05033④.....	Wall Mount Kit	1.....	✓	✓	✓
BAYTWGR0004.....	WEATHERGUARD™ Top - Fits unit base size of (W x D) of 37" X 34".....	1.....	✓	036-061	—
BAYTWGR0003.....	WEATHERGUARD™ Top - Fits unit base size of (W x D) of 33" X 30".....	1.....	—	018-030	—
BAYSDHG001A.....	Hail Guard Kit 3.2	1.....	—	—	—
BAYSDHG002A.....	Hail Guard Kit 3.3	1.....	—	—	—
BAYSDHG003A.....	Hail Guard Kit 4.3	1.....	—	—	—
BAYSDHG004A.....	Hail Guard Kit 4.4	1.....	—	—	—

A = Factory Installed

Comfort Controls – See Comfort Controls/Zone Sensors Section

- ① Not for use with programmable thermostats.
- ② Activated on Power Off.
- ③ Used for additional seacoast corrosion protection. Refer to bulletin number UN-SVB11A-EN for application information.
- ④ Available from Trane Parts.

TruComfort™ Variable Speed Heat Pumps Single Phase – 2-5 Tons



XV20i
(Variable Speed)

Table SH-1-A - XV20i R-410A Split System Variable Speed Heat Pump (25–100% capacity) – with Trane Link^①

Model Number	Power Supply	Nom. Cap. Cooling (BTUH)	Uncrated Dimensions (in.)			Shipping Weight (lbs.)	Sound** Rating		MCA*	Max. Fuse*	Line Size (in)	
			H	W	D		(Cool)	(Heat)			OD Gas	OD Liq.
4TWW0X24A1000A	208/230/1/60	24,000	46	33	30	236	54/65	60/69	17.0	25	3/4	3/8
4TWW0X36A1000A	208/230/1/60	36,000	47	37	34	278	59/70	60/72	26.0	40	3/4	3/8
4TWW0X48A1000A	208/230/1/60	48,000	47	37	34	290	61/74	62/76	29.0	45	7/8	3/8
4TWW0X60A1000A	208/230/1/60	54,000	51	37	34	300	57/73	61/74	37.0	50	7/8	3/8



XV19
(Variable Speed)

Table SH-1-B - XV19 R-410A Side Discharge Variable Speed Heat Pump (50–100% capacity) – with ComfortLink™ II^②

Model Number	Power Supply	Nom. Cap. Cooling (BTUH)	Uncrated Dimensions (in.)			Shipping Weight (lbs.)	Sound** Rating		MCA*	Max. Fuse*	Line Size (in)	
			H	W	D		(Cool)	(Heat)			OD Gas	OD Liq.
4TWL9024A1000B ^①	208/230/1/60	24,000	37	47	18	230	50	49	19.1	25	5/8	3/8
4TWL9036A1000B ^①	208/230/1/60	36,000	37	47	18	252	48	49	26.9	30	3/4	3/8
4TWL9048A1000B ^①	208/230/1/60	48,000	43	47	18	271	54	52	31.8	35	7/8	3/8
4TWL9060A1000B ^①	208/230/1/60	54,000	43	47	18	271	56	52	36.1	40	7/8	3/8



XV18
(Variable Speed)

Table SH-1-B - XV18 R-410A Split System Variable Speed Heat Pump (25–100% capacity) – with Trane Link^①

Model Number	Power Supply	Nom. Cap. Cooling (BTUH)	Uncrated Dimensions (in.)			Shipping Weight (lbs.)	Sound** Rating		MCA*	Max. Fuse*	Line Size (in)	
			H	W	D		(Cool)	(Heat)			OD Gas	OD Liq.
4TWW8X24A1000A	208/230/1/60	24,000	41	33	30	225	54/65	60/69	17.0	25	3/4	3/8
4TWW8X36A1000A	208/230/1/60	36,000	41	33	30	238	56/70	60/74	25.0	35	3/4	3/8
4TWW8X48A1000A	208/230/1/60	48,000	41	37	34	268	61/74	62/76	28.0	40	7/8	3/8
4TWW8X60A1000A	208/230/1/60	54,000	45	37	34	285	57/73	61/74	37.0	50	7/8	3/8

① Must use UX360 Smart Thermostat and SC360 System Control.

② Must use TCONT850, TZONE950 or TZONE1050 control.

* Information subject to change. Please confirm with current Product Data/Service Facts for current factory production.

** Rated in accordance with ARI Standard 275



WEATHERGUARD™ TOP ACCESSORY

BAYTWGR0003 - Fits base sizes 33"x30" (WxD)

BAYTWGR0004 - Fits base sizes 37"x34" (WxD)

TruComfort™ Variable Speed Heat Pumps Single Phase – 2-5 Tons

Table SH-2-A – Features

	XV20i (4TWV0)	XV19 (4TWL9)	XV18 (4TWV8)
• SEER2 up to	20.50	19.00	18.00
• HSPF2 up to	8.70	9.00	8.50
• Climatuff™ compressor.....	1	1	1
• Number of stages	Variable	Variable	Variable
• Comfort-R™ mode approved	✓	✓	✓
• Trane Link system.....	✓	✓	✓
• ComfortLink™ II system	–	✓	–
• DuraTuff™ base, fast completed rain, weatherproof	✓	–	✓
• Quick-Sess™ cabinet, service access & refrigerant connections with full coil protection	✓	–	✓
• SpineFin™ coil	✓	–	✓
• Weatherguard™ II top.....	✓	–	–
• Compressor sound enclosure	✓	✓	✓
• Compressor sump heat	✓	✓	✓
• Factory supplied charge.....	R-410A	R-410A	R-410A
• Glossy corrosion resistant finish.....	✓	✓	✓
• High pressure switch	✓	✓	✓
• Low pressure protection.....	✓	✓	✓
• Liquid line filter drier-factory supplied for field install	✓	✓	✓
• Seacoast shield-factory installed	✓	–	–
• Tarpaulin gray cabinet	✓	✓	✓
• 10-year registered limited warranty on compressor, outdoor coil & all other functional parts (Residential Use)*	–	✓	–
• 12-year registered limited warranty on compressor, 10-year on outdoor coil & all other functional parts (Residential Use)*	✓	–	✓
• Extended warranties available	✓	✓	✓

* Registered Limited Warranty terms are available when you register within 60 days of installation. You can register online at Trane.com or by phone at 855-260-2975, otherwise Trane's Base Limited Warranty terms will apply. Base Limited Warranty information on specific products can be found on ComfortSite.com.

Table SH-2-B – Optional Accessories

Model Number	Description	Shipping Weight			
BAYECMT023	Extreme Conditions Mounting Kit (Base 2/3)	2	2	–	024-036
BAYECMT004	Extreme Conditions Mounting Kit (Base 4)	2	3-5	–	048-060
BAYISLT101	Rubber Isolators	1	✓	✓	✓
BAYLEGS007	Snow Legs - 7" High (Black)	1	✓	✓	✓
BAYLEGS004	Snow Legs - 4" High (Black)	1	✓	✓	✓
BAYVDTA003	Vertical Discharge Air Kit Base 3	10	2	–	–
BAYVDTA004	Vertical Discharge Air Kit Base 4	10	3-5	–	–
BAYSEAC001	Seacoast Kit	1	–	–	✓
BAYWIND101	Wind Baffle Kit	5	–	✓	–
BAYSDHG003A	Hail Guard Kit 4.3	5	–	2-3	–
BAYSDHG004A	Hail Guard Kit 4.4	5	–	4-5	–
PAI00309①	Heresite Spraypaint	1	✓	✓	✓
BRK05033②	Wall Mount Kit	–	–	✓	–
BAYSEN01ATEMPA	External Ambient Kit	–	✓	✓	✓
BAYTWGR0004	WEATHERGUARD™ Top - Fits unit base size of (W x D) of 37" X 34"	–	–	–	048-060
BAYTWGR0003	WEATHERGUARD™ Top - Fits unit base size of (W x D) of 33" X 30"	–	–	–	024-036
BAYECC001	Extreme Coastal Conditions Kit*	–	✓	–	✓
BAYCAKT002	SmartCharge™ automatic charging solenoid kit	–	✓	–	✓

* Not for use in Arizona or other extreme heat applications.¹

Comfort Controls – See Comfort Controls/Zone Sensors Section

- ① Used for additional seacoast corrosion protection. Refer to bulletin number UN-SVB11A-EN for application information.
- ② Available from Trane Parts

Split System Heat Pumps Single Phase – 1½-5 Tons



**XL17i
(Two Stage)**



**XL15i
(Single Stage)**

Table SH-3-A – XL17i R-410A Split System Two Stage Heat Pump (70/100% capacity)

Model Number	Power Supply	Nom. Cap. Cooling (BTUH)	Uncrated Dimensions (in.)			Shipping Weight (lbs.)	Sound** Rating	MCA*	Max. Fuse*	Line Size (in)	
			H	W	D					OD Gas	OD Liq.
4TWX7024E1000A	208/230/1/60	24,000	47	37	34	305	72	15.0	25	5/8	3/8
4TWX7036E1000A	208/230/1/60	36,000	51	37	34	307	72	20.0	35	3/4	3/8
4TWX7048E1000A	208/230/1/60	48,000	51	37	34	360	72	27.0	45	7/8	3/8
4TWX7060E1000A	208/230/1/60	54,000	51	37	34	361	74	36.0	60	1 1/8	3/8

Table SH-3-B – XL15i R-410A Split System Single Stage Heat Pump

Model Number	Power Supply	Nom. Cap. Cooling (BTUH)	Uncrated Dimensions (in.)			Shipping Weight (lbs.)	Sound** Rating	MCA*	Max. Fuse*	Line Size (in)	
			H	W	D					OD Gas	OD Liq.
4TWX5018N1000A	208/230/1/60	18,000	38	33	30	208	71	15.0	25	3/4	3/8
4TWX5024N1000A	208/230/1/60	24,000	38	33	30	208	71	15.0	25	3/4	3/8
4TWX5030N1000A	208/230/1/60	30,000	43	37	34	200	71	15.0	25	3/4	3/8
4TWX5036N1000A	208/230/1/60	36,000	43	37	34	255	70	18.0	30	7/8	3/8
4TWX5042N1000A	208/230/1/60	42,000	51	37	34	297	72	24.0	40	7/8	3/8
4TWX5048N1000A	208/230/1/60	48,000	51	37	34	320	72	26.0	40	7/8	3/8
4TWX5060N1000A	208/230/1/60	54,000	51	37	34	320	72	32.0	50	1 1/8	3/8

* Information subject to change. Please confirm with current Product Data/Service Facts for current factory production.

** Rated in accordance with ARI Standard 275

Split System Heat Pumps Single Phase – 1½-5 Tons

Table SH-4-A – Features

	XL17i (4TWX7)	XL15i (4TWX5)
• SEER2 up to	17.20	15.60
• HSPF2 up to	8.0	7.8
• Climatuff™ compressor.....	1	1
• Number of stages	2	1
• Comfort-R™ mode approved	✓	✓
• DuraTuff™ base, fast complete drain, weatherproof	✓	✓
• Quick-Sess™ cabinet, service access & refrigerant connections with full coil protection	✓	✓
• Spine Fin™ coil	✓	✓
• Weatherguard™ II top.....	✓	✓
• Electronic Expansion Valve (EEV)	✓	—
• Compressor sump heat - factory installed	✓	—
• Factory supplied charge.....	R-410A	R-410A
• Glossy corrosion resistant finish.....	✓	✓
• High pressure switch	✓	✓
• Low pressure switch	✓	✓
• Liquid line filter drier - factory installed or field supplied	✓	✓
• Seacoast shield - factory installed.....	✓	✓
• Tarpaulin gray cabinet	✓	✓
• 12-year registered limited warranty on compressor, 10-year on outdoor coil & all other functional parts (Residential Use)*.....	✓	✓
• Extended warranties available	✓	✓

* Registered Limited Warranty terms are available when you register within 60 days of installation. You can register online at Trane.com or by phone at 855-260-2975, otherwise Trane's Base Limited Warranty terms will apply. Base Limited Warranty information on specific products can be found on ComfortSite.com.

Table SH-4-B – Optional Accessories

Model Number	Description	Shipping Weight		
AY28X084.....	Evap. Defrost Control Kit	1.....	✓	✓
BAYECMT023	Extreme Conditions Mounting Kit (Base 2/3)	2.....	—	1½-2
BAYECMT004	Extreme Conditions Mounting Kit (Base 4).....	2.....	✓	2½-5
BAYISLT101	Rubber Isolators.....	1.....	✓	✓
BAYCCHT301RES	Crankcase Heater Kit	1.....	—	3½-5
BAYCCHT302RES	Crankcase Heater Kit	1.....	—	1½-3
BAYKSKT263	Start kit (Scroll).....	1.....	2-3	✓
BAYKSKT266	Start kit (Scroll).....	1.....	4-5	—
BAYLEGS007	Snow Legs - 7" High (Black).....	1.....	✓	✓
BAYLEGS004	Snow Legs - 4" High (Black).....	1.....	✓	✓
BAYLOAM107A	Low Ambient Kit.....	1.....	✓	✓
BAYVDTA003	Vertical Discharge Air Kit Base 3.....	10.....	—	1½-2
BAYVDTA004	Vertical Discharge Air Kit Base 4.....	10.....	✓	2½-5
TAYASCT501A①②	Anti-Short Cycle Timer.....	2.....	✓	✓
PAI00309③.....	Heresite Spraypaint.....	1.....	✓	✓

Comfort Controls – See Comfort Controls/Zone Sensors Section

- ① Do not use with programmable thermostats.
- ② Activated on Power Off.
- ③ Used for additional seacoast corrosion protection. Refer to bulletin number UN-SVB11A-EN for application information.

Split System Heat Pumps

Split System Heat Pumps Single Phase – 1½-5 Tons

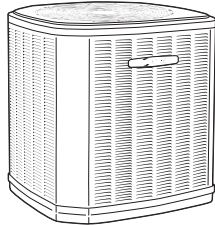

**XR16
(Two Stage)**

Table SH-5-A – XR16 R-410A Split System Two Stage Heat Pump (70/100% capacity)

Model Number	Power Supply	Nom. Cap. Cooling (BTUH)	Uncrated Dimensions (in.)			Shipping Weight (lbs.)	Sound** Rating	MCA*	Max. Fuse*	Line Size (in)	
			H	W	D					OD Gas	OD Liq.
4TWR6024N1000A	208/230/1/60	24,000	41	37	34	272	72	15.0	25	5/8	3/8
4TWR6036N1000A	208/230/1/60	36,000	45	37	34	307	72	20.0	35	3/4	3/8
4TWR6048N1000A	208/230/1/60	48,000	45	37	34	329	72	28.0	45	7/8	3/8
4TWR6060N1000A	208/230/1/60	54,000	45	37	34	330	74	35.0	60	1 1/8	3/8

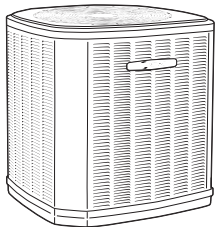

**XR15
(Single Stage)**

Table SH-5-B – XR15 R-410A Split System Single Stage Heat Pump

Model Number	Power Supply	Nom. Cap. Cooling (BTUH)	Uncrated Dimensions (in.)			Shipping Weight (lbs.)	Sound** Rating	MCA*	Max. Fuse*	Line Size (in)	
			H	W	D					OD Gas	OD Liq.
4TWR5018N1000A	208/230/1/60	18,000	33	33	30	208	71	15.0	20	3/4	3/8
4TWR5024N1000A	208/230/1/60	24,000	33	33	30	208	71	15.0	25	3/4	3/8
4TWR5030N1000A	208/230/1/60	30,000	29	33	30	191	71	15.0	25	3/4	3/8
4TWR5036N1000A	208/230/1/60	36,000	37	37	34	246	70	18.0	30	3/4	3/8
4TWR5042N1000A	208/230/1/60	42,000	45	37	34	277	72	24.0	40	7/8	3/8
4TWR5048N1000A	208/230/1/60	48,000	45	37	34	300	72	26.0	40	7/8	3/8
4TWR5060N1000A	208/230/1/60	54,000	45	37	34	301	72	32.0	50	1 1/8	3/8

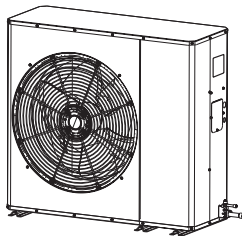

**XR15
(Single Stage)**

Table SH-5-C – XR15 R-410A Split System Single Stage Heat Pump

Model Number	Power Supply	Nom. Cap. Cooling (BTUH)	Uncrated Dimensions (in.)			Shipping Weight (lbs.)	Sound** Rating	MCA*	Max. Fuse*	Line Size (in)	
			H	W	D					OD Gas	OD Liq.
4TWL5024N1000Aⓐ	208/230/1/60	24,000	37	47	18	224	70	15.0	25	3/4	3/8
4TWL5030N1000Aⓐ	208/230/1/60	30,000	37	47	18	224	70	15.0	25	3/4	3/8
4TWL5036N1000Aⓐ	208/230/1/60	36,000	37	47	18	226	71	17.0	30	7/8	3/8
4TWL5042N1000Aⓐ	208/230/1/60	42,000	43	47	18	266	74	24.0	40	7/8	3/8
4TWL5048N1000Aⓐ	208/230/1/60	48,000	43	47	18	266	74	24.0	40	7/8	3/8

ⓐ For coastal applications where units are installed within one (1) mile of salt water, epoxy coated models are available for order. Model numbers with "COT" in the eleventh (11) through thirteenth (13) digits represent an epoxy coated coil. Example: 4TW-L6036A1COTA

These models have an 8 week lead time after order.

* Information subject to change. Please confirm with current Product Data/Service Facts for current factory production.

** Rated in accordance with AHRI Standard 270-2008 (Min/Max when applicable).

Split System Heat Pumps Single Phase – 1½-5 Tons

Table SH-6-A – Features

	XR16 (4TWR6)	XR15 (4TWR5)	XR15 (4TWL5)
• SEER2 up to.....	16.20	15.60	15.60
• HSPF2 up to	8.0	7.80	8.0
• Climatuff™ compressor	✓	✓	✓
• Comfort-R™ mode approved.....	✓	✓	✓
• DuraTuff™ base, fast complete drain, weatherproof	✓	✓	—
• Quick-Sess™ cabinet, service access & refrigerant connections with full coil protection.....	✓	✓	—
• Spine Fin™ coil	✓	✓	—
• Copper/Aluminum coil.....	—	—	✓
• Compressor sump heat - factory installed	✓	—	—
• Factory supplied charge.....	R-410A	R-410A	R-410A
• Glossy corrosion resistant finish	✓	✓	✓
• High pressure switch.....	✓	✓	✓
• Low pressure switch	✓	✓	✓
• Internal high / low pressure & temperature protection	—	✓	✓
• Liquid line filter drier - factory supplied for field install.....	✓	✓	✓
• Tarpaulin gray cabinet.....	✓	✓	✓
• 10-year registered limited warranty on compressor, outdoor coil & all other functional parts (Residential Use)* ..	✓	✓	✓
• Extended warranties available.....	✓	✓	✓

* Registered Limited Warranty terms are available when you register within 60 days of installation. You can register online at Trane.com or by phone at 855-260-2975, otherwise Trane's Base Limited Warranty terms will apply. Base Limited Warranty information on specific products can be found on ComfortSite.com.

Table SH-6-B – Optional Accessories

Model Number	Description	Shipping Weight			
AY28X084.....	Evap. Defrost Control Kit	1	✓	✓	✓
BAYCCHT301RES	Crankcase Heater Kit.....	1	—	3½-5	3½-5
BAYCCHT302RES	Crankcase Heater Kit.....	1	—	1½-3	1½-3
BAYECMT023	Extreme Conditions Mounting Kit (Base 2/3).....	2	—	1½-2	—
BAYECMT004	Extreme Conditions Mounting Kit (Base 4).....	2	✓	2½-5	—
BAYISLT101	Rubber Isolators.....	1	✓	✓	✓
BAYKSKT263.....	Start Kit (Scroll)	1	2-3	✓	✓
BAYKSKT266	Start Kit (Scroll)	1	4-5	—	—
BAYLEGS007.....	Snow Legs - 7" High (Black).....	1	✓	✓	✓
BAYLEGS004.....	Snow Legs - 4" High (Black).....	1	✓	✓	✓
BAYLOAM107A	Low Ambient Kit.....	1	✓	✓	✓
BAYSDEN004	Large Scroll Compressor Enclosures	8	✓	✓	✓
BAYSEAC001	Seacoast Kit	1	✓	✓	—
BAYWIND100.....	Wind Baffle	—	—	—	1½-2
BAYWIND101.....	Wind Baffle	—	—	—	2½-5
BAYSDHG002A.....	Hail Guard Kit 3.3	5	—	—	1½-2½
BAYSDHG003A.....	Hail Guard Kit 4.3	5	—	—	3-4
BAYSDHG004A.....	Hail Guard Kit 4.4	5	—	—	5
TAYSVPANL3343AA	Service Valve Panel Cover Kit	2	2-3	1½-2	—
TAYSVPANL0044AA	Service Valve Panel Cover Kit	2	4-5	2½-3	—
TAYSVPANL0046AA	Service Valve Panel Cover Kit	2	—	3½-5	—
TAYASCT501Aⓐⓑ	Anti-Short Cycle Timer.....	2	✓	✓	—
PAI00309ⓐ	Heresite Spraypaint.....	1	✓	✓	✓
BRK05033ⓐ	Wall Mount Kit	—	—	—	✓
BAYTWGR0004	WEATHERGUARD™ Top - Fits unit base size of (W x D) of 37" X 34".....	—	024-060	030-060	—
BAYTWGR0003	WEATHERGUARD™ Top - Fits unit base size of (W x D) of 33" X 30".....	—	—	018-024	—

Comfort Controls – See Comfort Controls/Zone Sensors Section

- ⓐ Do not use with programmable thermostats.
- ⓑ Activated on Power Off.
- ⓒ Used for additional seacoast corrosion protection. Refer to bulletin number UN-SVB11A-EN for application information.
- ⓓ Available from Trane Parts.

Split System Heat Pumps Single Phase – 1½-5 Tons

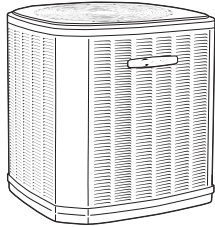

**XR14
(Single Stage)**

Table SH-7-B – XR14 R-410A Split System Single Stage Heat Pump

Model Number	Power Supply	Nom. Cap. Cooling (BTUH)	Uncrated Dimensions (in.)			Shipping Weight (lbs.)	Sound** Rating	MCA*	Max. Fuse*	Line Size (in)	
			H	W	D					OD Gas	OD Liq.
4TWR4017N1000A	208/230/1/60	18,000	28.72	28.5	25.625	161	73	12	20	¾	¾
4TWR4018N1000A	208/230/1/60	18,000	33	33	30	208	71	15.0	20	¾	¾
4TWR4024N1000A	208/230/1/60	24,000	33	33	30	208	71	15.0	25	¾	¾
4TWR4030N1000A	208/230/1/60	30,000	29	33	30	191	71	15.0	25	¾	¾
4TWR4036N1000A	208/230/1/60	36,000	37	37	34	246	70	18.0	30	7/8	¾
4TWR4042N1000A	208/230/1/60	42,000	45	37	34	277	72	24.0	40	7/8	¾
4TWR4048N1000A	208/230/1/60	48,000	45	37	34	300	72	26.0	45	7/8	¾
4TWR4060N1000A	208/230/1/60	54,000	45	37	34	301	72	32.0	50	1 1/8	¾

* Information subject to change. Please confirm with current Product Data/Service Facts for current factory production.

** Rated in accordance with ARI Standard 275

ONLINE ONLY COPY

Split System Heat Pumps

Split System Heat Pumps Single Phase – 1½-5 Tons

Table SH-8-A – Features

	XR14 (4TWR4)
• SEER2 up to	14.80
• HSPF2 up to	7.80
• Climatuff™ compressor.....	✓
• Comfort-R™ mode approved	✓
• DuraTuff™ base, fast complete drain, weatherproof.....	✓
• Quick-Sess™ cabinet, service access & refrigerant connections with full coil protection	✓
• Spine Fin™ coil	✓
• Factory supplied charge.....	R-410A
• Glossy corrosion resistant finish.....	✓
• High pressure switch	✓
• Low pressure switch	✓
• Internal high / low pressure & temperature protection	✓
• Liquid line filter drier - factory supplied for field install.....	✓
• Tarpaulin gray cabinet	✓
• 10-year registered limited warranty on compressor, outdoor coil & all other functional parts (Residential Use)*	✓
• Extended warranties available.....	✓

* Registered Limited Warranty terms are available when you register within 60 days of installation. You can register online at Trane.com or by phone at 855-260-2975, otherwise Trane's Base Limited Warranty terms will apply. Base Limited Warranty information on specific products can be found on ComfortSite.com.

Table SH-8-B – Optional Accessories

Model Number	Description	Shipping Weight	
AY28X084.....	Evap. Defrost Control Kit	1.....	✓
BAYCCHT301RES	Crankcase Heater Kit.....	1.....	3½-5
BAYCCHT302RES	Crankcase Heater Kit.....	1.....	1½-3
BAYECMT023	Extreme Conditions Mounting Kit (Base 2/3)	2.....	1½-2
BAYECMT004	Extreme Conditions Mounting Kit (Base 4).....	2.....	2½-5
BAYISLT101	Rubber Isolators.....	1.....	✓
BAYKSKT263	Start Kit (Scroll)	1.....	✓
BAYLEGS007	Snow Legs - 7" High (Black).....	1.....	✓
BAYLEGS004	Snow Legs - 4" High (Black).....	1.....	✓
BAYLOAM107A	Low Ambient Kit.....	1.....	✓
BAYSDEN001	Small Scroll Compressor Enclosures.....	8.....	1½-3½
BAYSDEN004	Large Scroll Compressor Enclosures	8.....	4-5
BAYSEAC001	Seacoast Kit	1.....	✓
TAYSVPANL0022AA ...	Service Valve Panel Cover Kit	2.....	1½
TAYSVPANL0032AA ...	Service Valve Panel Cover Kit	2.....	2-3½
TAYSVPANL3343AA ...	Service Valve Panel Cover Kit	2.....	4
TAYSVPANL0044AA ...	Service Valve Panel Cover Kit	2.....	—
TAYSVPANL0046AA ...	Service Valve Panel Cover Kit	2.....	5
TAYASCT501A①②	Anti-Short Cycle Timer.....	2.....	✓
PAI00309③	Heresite Spraypaint.....	1.....	✓
BAYTWGR0004	WEATHERGUARD™ Top - Fits unit base size of (W x D) of 37" X 34"		030-060
BAYTWGR0003	WEATHERGUARD™ Top - Fits unit base size of (W x D) of 33" X 30"		024

Comfort Controls – See Comfort Controls/Zone Sensors Section

- ① Do not use with programmable thermostats.
- ② Activated on Power Off.
- ③ Used for additional seacoast corrosion protection. Refer to bulletin number UN-SVB11A-EN for application information.

Split System Heat Pumps Three Phase

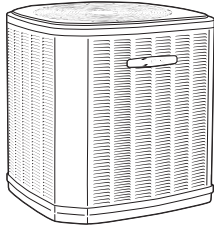

**XR17
(Two Stage)
3-Phase**

Table SH-9-A — XR17 R-410A Split System Two Stage Heat Pump — Three Phase

Model Number	Power Supply	Nom. Cap. Cooling (BTUH)	Uncrated Dimensions (in.)			Shipping Weight (lbs.)	Sound** Rating	MCA*	Max. Fuse*	Line Size (in)	
			H	W	D					OD Gas	OD Liq.
4TWA7036A3000A	208/230/3/60	36,000	54	37	34	307	72	15.0	25	3/4	3/8
4TWA7048A3000A	208/230/3/60	48,000	45	37	34	323	73	18.0	30	7/8	3/8
4TWA7060A3000A	208/230/3/60	54,000	45	37	34	326	74	22.0	35	7/8	3/8
4TWA7036A4000A	460/3/60	36,000	54	37	34	307	72	8.0	15	3/4	3/8
4TWA7048A4000A	460/3/60	48,000	45	37	34	323	73	9.0	15	7/8	3/8
4TWA7060A4000A	460/3/60	54,000	45	37	34	326	74	10.0	15	7/8	3/8

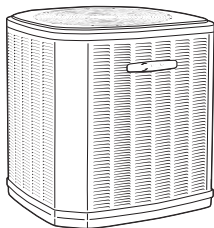

**XR14
(Single Stage)
3-Phase**

Table SH-9-B — XR14 R-410A Split System Single Stage Heat Pump — Three Phase

Model Number	Power Supply	Nom. Cap. Cooling (BTUH)	Uncrated Dimensions (in.)			Shipping Weight (lbs.)	Sound** Rating	MCA*	Max. Fuse*	Line Size (in)	
			H	W	D					OD Gas	OD Liq.
4TWA4036A3000A	208/230/3/60	36,000	29	37	34	248	75	13.0	20	7/8	3/8
4TWA4042A3000A	208/230/3/60	42,000	29	37	34	248	74	18.0	30	7/8	3/8
4TWA4048A3000A	208/230/3/60	48,000	33	37	34	252	74	18.0	30	7/8	3/8
4TWA4060A3000A	208/230/3/60	54,000	45	37	34	325	74	21.0	35	7/8	3/8
4TWA4036A4000A	460/3/60	36,000	29	37	34	248	75	6.0	15	7/8	3/8
4TWA4042A4000A	460/3/60	42,000	29	37	34	248	74	8.0	15	7/8	3/8
4TWA4048A4000A	460/3/60	48,000	33	37	34	252	74	8.0	15	7/8	3/8
4TWA4060A4000A	460/3/60	54,000	45	37	34	324	74	9.0	15	7/8	3/8

* Information subject to change. Please confirm with current Product Data/Service Facts for current factory production.

** Rated in accordance with AHRI Standard 270-2008 (Min/Max when applicable).

Split System Heat Pumps Three Phase

Table SH-10-A – Features

	XR17 (4TWA7)	XR14 (4TWA4)
• SEER up to.....	17.5	15.5
• HSPF up to	9.60	9.50
• Climatuff™ compressor	✓	✓
• Comfort-R™ mode approved	✓	✓
• DuraTuff™ base, fast complete drain, weatherproof	✓	✓
• Quick-Sess™ cabinet, service access & refrigerant connections with full coil protection.....	✓	✓
• Spine Fin™ coil	✓	✓
• Copper/Aluminum coil.....	✓	—
• Compressor sump heat - factory installed	✓	✓
• Refrigerant	R-410A	R-410A
• Glossy corrosion resistant finish	✓	✓
• High pressure switch.....	✓	✓
• Low pressure switch	✓	✓
• Internal high / low pressure & temperature protection	—	—
• Liquid line filter drier - factory supplied	✓	✓
• Tarpaulin gray cabinet.....	—	—
• 5-year basic limited warranty on compressor, 1-year on outdoor coil & all other functional parts (Commercial Use).....	✓	✓
• 10-year registered limited warranty on compressor, outdoor coil & all other functional parts (Residential Use)*.....	—	—
• Extended warranties available.....	✓	✓

* Registered Limited Warranty terms are available when you register within 60 days of installation. You can register online at Trane.com or by phone at 855-260-2975, otherwise Trane's Base Limited Warranty terms will apply. Base Limited Warranty information on specific products can be found on ComfortSite.com.

Table SH-10-B – Optional Accessories

Model Number	Description	Shipping Weight		
AY28X084.....	Evaporator Defrost Control HP	1.....	✓	✓
BAYECMT004	Extreme Conditions Mounting Kit (Base 4).....	2.....	3-5	3-5
BAYISLT101	Rubber Isolators.....	1.....	✓	✓
BAYLEGS007	Snow Legs - 7" High (Black).....	1.....	✓	✓
BAYLEGS004	Snow Legs - 4" High (Black).....	1.....	✓	✓
BAYLOAM107A	Low Ambient Kit.....	1.....	✓	✓
BAYSDEN001	Small Scroll Compressor Enclosures.....	8.....	—	3-3½
BAYSDEN004	Large Scroll Compressor Enclosures	8.....	✓	4-5
BAYSEAC001.....	Seacoast Kit	1.....	✓	✓
TAYASCT501A①②.....	Anti-short cycle timer.....	2.....	✓	4
PAI00309③.....	Heresite Spraypaint.....	1.....	✓	—
TAYSVPANL0032AA	Service Valve Panel Cover Kit	2.....	—	3-3½
TAYSVPANL0046AA	Service Valve Panel Cover Kit	2.....	3-5	5
TAYSVPANL3343AA	Service Valve Panel Cover Kit	2.....	—	4
BRK05033④.....	Wall Mount Kit.....	—	—
BAYTWGR0004	WEATHERGUARD™ Top - Fits unit base size of (W x D) of 37" X 34"	✓	✓
BAYSDHG003A.....	Hail Guard Kit 4.3	—	—
BAYSDHG004A.....	Hail Guard Kit 4.4	—	—

Comfort Controls – See Comfort Controls/Zone Sensors Section

- ① Do not use with programmable thermostats.
- ② Activated on Power Off.
- ③ Used for additional seacoast corrosion protection. Refer to bulletin number UN-SVB11A-EN for application information.
- ④ Available from Trane Parts.

Split System Heat Pumps



It's Hard To Stop A Trane.®

Features and Benefits

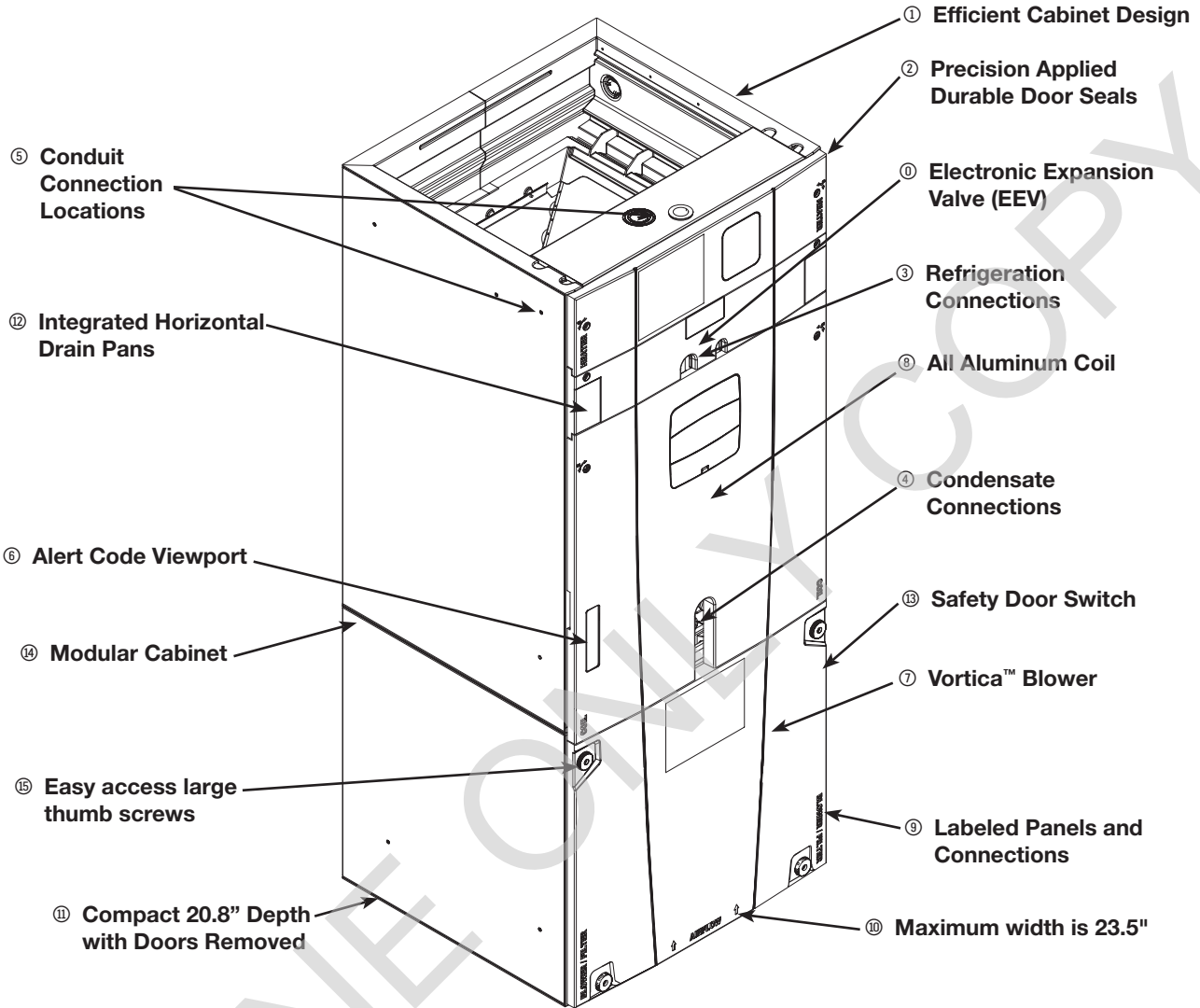

- ① **Efficient Cabinet Design**
 - Double wall foamed cabinet system
 - Waterproof Cabinet Design (No Thermal Breakage)
 - \geq R-4.2 Insulating Value
 - Composite Cabinet Doors
 - Sweat Eliminating Cabinet Design
 - Loose Fiber Eliminating Design
 - Smooth Cleanable Cabinet Design
- ② **Precision Applied Durable Door Seals**
- ③ **Refrigeration Connections**
- ④ **Condensate Connections**
- ⑤ **Conduit Connection Locations** - Dimples in cabinet mark Conduit Connection Locations for Left, Right, and Top
- ⑥ **Alert Code Viewport**
 - Alert Codes can be Viewed Without Door Removal
 - Control Protection Pocket
- ⑦ **Vortica™ Blower**
 - Polarized Plug Connections
 - Integrated Slide Deck for Easy Removal

- ⑧ **All Aluminum Coil**
 - Integrated Slide Deck for Easy Removal
 - Polarized Plug connections on Coil EEV
 - Patented Enhanced Coil Fin
- ⑨ **Labeled Panels and Connections**
- ⑩ **Electronic Expansion Valve (EEV)**
 - Low Ambient and Low Superheat Compressor Protection
 - Dual Refrigerant Compatible as Shipped
- ⑪ **Maximum width is 23.5"**
- ⑫ **Integrated Horizontal Drain Pans**
- ⑬ **Safety Door Switch - Fused 24V Power**
- ⑭ **Modular Cabinet**
- ⑮ **Easy access large thumb screws**

For complete equipment / combination selections, installation instructions and warranty information, please refer to Product Data/Ratings and/or Installers Guides and Limited Warranty Handbooks.



Hyperion, TAMX Variable Speed Multi-Position Air-Tite™ Air Handlers 2-5 Tons

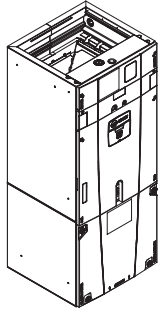

Table AH-2-A — Trane Link or 24V Variable Speed R-410A with Smart Fan Options 200-230/1/60, Epoxy Coated Coil

Model Number	Cooling Capacity (Btuh)	Dimensions (in.) H x W x D	Shipping Weight (lbs.)	Supply Opening	Return Opening	Filter Sizes	Line Size (in)	
							Gas	Liquid
TAMXB0A24V21DA	24,000	49.9 x 17.5 x 21.8	126	14.5 x 14.35	14.5 x 17.15	16 x 20 x 1	3/4	3/8
TAMXB0B30V31DA	30,000	55.7 x 21.3 x 21.8	150	18.4 x 14.35	18.4 x 17.15	20 x 20 x 1	3/4	3/8
TAMXB0C36V31DA	36,000	56.9 x 23.5 x 21.8	157	20.5 x 14.35	20.5 x 17.15	22 x 20 x 1	7/8	3/8
TAMXB0C42V41DA	42,000	56.9 x 23.5 x 21.8	162	20.5 x 14.35	20.5 x 17.15	22 x 20 x 1	7/8	3/8
TAMXB0C48V41DA	48,000	61.7 x 23.5 x 21.8	174	20.5 x 14.35	20.5 x 17.15	22 x 20 x 1	7/8	3/8
TAMXB0C60V51DA	60,000	61.7 x 23.5 x 21.8	175	20.5 x 14.35	20.5 x 17.15	22 x 20 x 1	7/8	3/8

Hyperion, TAM9 Variable Speed Multi-Position Air-Tite™ Air Handlers 2-5 Tons

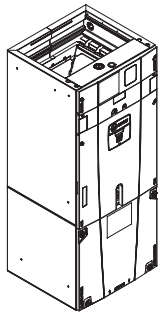

Table AH-2-B — ComfortLink™ II or 24V Variable Speed R-410A with Smart Fan Options 200-230/1/60, Epoxy Coated Coil

Model Number	Cooling Capacity (Btuh)	Dimensions (in.) H x W x D	Shipping Weight (lbs.)	Supply Opening	Return Opening	Filter Sizes	Line Size (in)	
							Gas	Liquid
TAM9A0A24V21DB	24000	49.9 x 17.5 x 21.8	126	14.5 x 14.35	14.5 x 17.15	16 x 20 x 1	3/4	3/8
TAM9A0B30V31DB	30000	55.7 x 21.3 x 21.8	150	18.4 x 14.35	18.4 x 17.15	20 x 20 x 1	3/4	3/8
TAM9A0C36V31DB	36000	56.9 x 23.5 x 21.8	157	20.5 x 14.35	20.5 x 17.15	22 x 20 x 1	7/8	3/8
TAM9A0C42V41DB	42000	56.9 x 23.5 x 21.8	162	20.5 x 14.35	20.5 x 17.15	22 x 20 x 1	7/8	3/8
TAM9A0C48V41DB	48000	61.7 x 23.5 x 21.8	174	20.5 x 14.35	20.5 x 17.15	22 x 20 x 1	7/8	3/8
TAM9A0C60V51DB	60000	61.7 x 23.5 x 21.8	175	20.5 x 14.35	20.5 x 17.15	22 x 20 x 1	7/8	3/8



Hyperion, TAMX and TAM9 Variable Speed Multi-Position Air-Tite™ Air Handlers 2-5 Tons

Table AH-3-A — Features

	TAMX	TAM9
• Trane® Link or 24 Volt control ^②	✓	—
• ComfortLink™ II or 24 Volt control.....	—	✓
• Capability to connect to Trane Link mobile application to conduct setup, view diagnostics, error codes, and more.....	✓	—
• Alert port to view control board codes without door removal.....	✓	✓
• 5 button user interface and clear description of set up.....	—	✓
• Comfort R™ mode.....	✓ ^①	✓
• Efficient cabinet design.....	✓	✓
– 2% or less air leakage.....	✓	✓
– Precision applied - durable door seals.....	✓	✓
– Specially designed air seal around refrigerant, condensate and conduit connections.....	✓	✓
– Double wall foamed cabinet system.....	✓	✓
– ≥ R-4.2 insulating value.....	✓	✓
– No loose fiber design.....	✓	✓
– Smooth cleanable interior design.....	✓	✓
– Sweat eliminating design.....	✓	✓
– Composite cabinet doors.....	✓	✓
– Water proof cabinet design.....	✓	✓
– Integrated horizontal drain pans.....	✓	✓
– Modular cabinet.....	✓	✓
• Multi-position up/down flow horizontal left/right.....	✓	✓
• Side return option (sold as accessory).....	✓	✓
• UVC light kit with safety switch and polarized plug connections (sold as accessory).....	✓	✓
• Alert code notification.....	✓	✓
• Low voltage terminal connection point.....	✓	✓
• Vortica® blower with polarized plug connections and integrated slide deck for easy removal.....	✓	✓
• Aluminum coil with integrated slide deck for easy removal and polarized plug connections on coil EEV.....	✓	✓
• Patented enhanced coil fin.....	✓	✓
• Epoxy coated coil.....	✓	✓
• Electronic Expansion Valve (EEV) with low ambient and low superheat compressor protection.....	✓	✓
• Dual refrigerant compatible as shipped.....	✓	✓
• Slide in electric heaters with polarized plug connections (sold as accessory).....	✓	✓
• Slide in hot water coils with polarized plug connections (sold as accessory).....	✓	✓
• Labeled panels and connections.....	✓	✓
• Molded in 1" standard filter rail.....	✓	✓
• Direct drive, variable speed ECM blower motor - Constant airflow ECM (electronically commutated motor).....	✓	✓
• Soft start fan motor operation.....	✓	✓
• Built in fan delay modes.....	✓	✓
• Maximum width of 23.5".....	✓	✓
• Compact 20.8" depth with doors removed.....	✓	✓
• Fused 24v power.....	✓	✓
• 10-year limited warranty/parts with registration*	✓	✓
• 10-year limited warranty/coil with registration*	✓	✓

① Comfort R mode is configurable through the tech app on TAMX products

② Models with a B in the 5th digit or later can operate in either Trane Link or 24V mode. Prior revisions are Trane Link only.

* Registered Limited Warranty terms are available when you register within 60 days of installation. You can register online at Trane.com or by phone at 855-260-2975, otherwise Trane's Base Limited Warranty terms will apply. Base Limited Warranty information on specific products can be found on ComfortSite.com.



Hyperion, TAMX and TAM9 Variable Speed Multi-Position Air-Tite™ Air Handlers 2-5 Tons

Table AH-4-A — Optional Accessories

Model Number	Description	Matches Cabinet Size ①	TAMX	TAM9
BAYAHPTKT	Air Handler Pressure Transducer Kit	A to C	✓	—
BAYSUPFLGAA	Supply Duct Flange A	A	✓	✓
BAYSUPFLGBA	Supply Duct Flange B	B	✓	✓
BAYSUPFLGCA	Supply Duct Flange C	C	✓	✓
BAYRETLGAA	Supply Duct Flange A	A	✓	✓
BAYRETLGBA	Supply Duct Flange B	B	✓	✓
BAYRETLGCA	Supply Duct Flange C	C	✓	✓
BAYSRKIT100A	Side Return Kit	A to C	✓	✓
BAYFLR1620A	High Velocity Filter Kit, 16" x 20" x 1" (10 filters)	A	✓	✓
BAYFLR2020A	High Velocity Filter Kit, 20" x 20" x 1" (10 filters)	B	✓	✓
BAYFLR2220A	High Velocity Filter Kit, 22" x 20" x 1" (10 filters)	C	✓	✓
TASB175SB ②⑤	Plenum Stand with integrated sound baffle A	A	✓	✓
TASB215SB ②⑤	Plenum Stand with integrated sound baffle B	B	✓	✓
TASB235SB ②⑤	Plenum Stand with integrated sound baffle C	C	✓	✓
MITISRKIT01 ②	Side Return Kit with 16" x 20" Filter	A to C	✓	✓
BAYFRKIT175	Front Return Kit for 17.5" Cabinet	A	✓	✓
BAYFRKIT210	Front Return Kit for 21.0" Cabinet	B	✓	✓
BAYFRKIT235	Front Return Kit for 23.5" Cabinet	C	✓	✓
TAYBASETAMA	Downflow Sub-Base Kit	A to C	✓	✓
BAYBAFKT175A ⑦	Sound Baffle Kit for 17.5" Cabinet	A	✓	✓
BAYBAFKT215A ⑦	Sound Baffle Kit for 21.0" Cabinet	B	✓	✓
BAYBAFKT235A ⑦	Sound Baffle Kit for 23.5" Cabinet	C	✓	✓
TASSBK175 ②④⑥	Sound Baffle Kit for 17.5" Cabinet	A	✓	✓
TASSBK210 ②④⑥	Sound Baffle Kit for 21.0" Cabinet	B	✓	✓
TASSBK235 ②④⑥	Sound Baffle Kit for 23.5" Cabinet	C	✓	✓
BAYICKSKIT01A	Internal Condensate Switch Kit	A to C	✓	✓
BAYHHKIT001A	Horizontal Hanger Kit	A to C	✓	✓
BAYUVCLK001A	UVC Lights	A to C	✓	✓
BAYLVKIT100A	Low Voltage Conduit Entry Kit	A to C	✓	✓
BAYSPEKT200A	Single Power Entry Kit	A to C	✓	✓
BAYWAAA05SC1AA	Hydronic Coil — 50,000 BTUH — Slide-in	A	✓	✓
BAYWABB07SC1AA	Hydronic Coil — 70,000 BTUH — Slide-in	B	✓	✓
BAYWACC08SC1AA	Hydronic Coil — 80,000 BTUH — Slide-in	C	✓	✓
BAYWACC11SC1AA	Hydronic Coil — 100,000 BTUH — Slide-in	C	✓	✓
BAYWAKIT24VAC	Hydronic Heater Relay Kit — (used in Communicating mode only)	A to C	✓	✓
BAYCNDPIP01A	3/4" PVC Threaded Pipe Kit foam Seal (10 per box)	A to C	✓	✓
BAYAHMIKIT001A	EMI/EFI Air Handler Electronic noise kit for variable speed blower motor	A to C	✓	✓

- ① A Cabinet is 17.5" wide, B Cabinet is 21.5" wide, C Cabinet is 23.5" wide.
- ② Contact your distributor for information.
- ③ TCONT900 Thermostat can not be used with Hydronic heating.
- ④ In return plenum applications, use TASSBK kits for sound reduction.
- ⑤ In open air applications, Plenum Stand with Sound Baffle provides sound reduction.
- ⑥ Mounts to TASB original plenum stands without integrated sound baffle.
- ⑦ Mounts inside air filter channel on air handler.

Multi-position Air Handler

* Note: No internal modifications required for any position.

① Badge rotation will keep brand in correct position

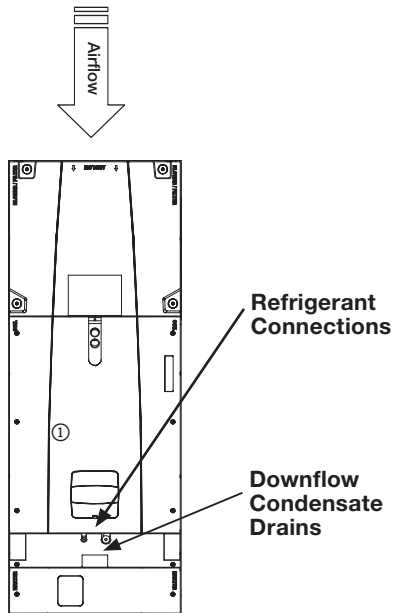

Vertical Downflow*

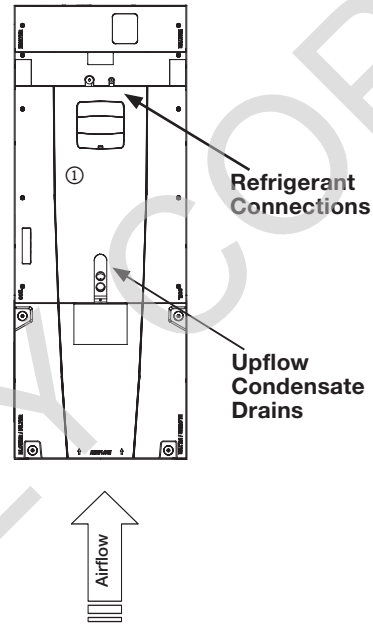

Vertical Upflow*
(as shipped)

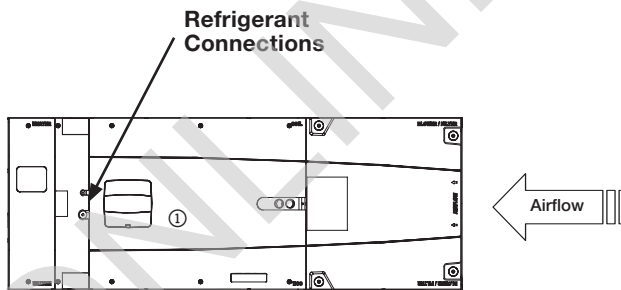

Horizontal Left*

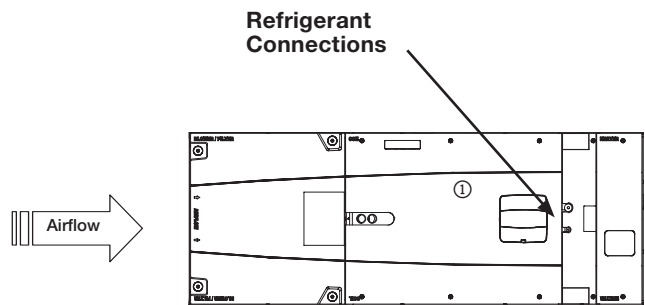

Horizontal Right*

Hyperion, GAM5 Multi-Position Air Handlers Single Phase 1½-5 Tons

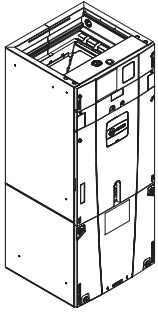

Table AH-6-A — Multi-Speed High Efficiency Motor 200-230/1/60, Epoxy Coated Coil

Model Number	Cooling Capacity (Btuh)	Dimensions (in.) H x W x D	Shipping Weight (lbs.)	Supply Opening	Return Opening	Filter Sizes	Line Size (in)	
							Gas	Liquid
GAM5B0A18M11EA	18000	49.9 x 17.5 x 21.8	126	14.5 x 14.35	14.5 x 17.15	16 x 20 x 1	¾	¾
GAM5B0A24M21EA	24000	49.9 x 17.5 x 21.8	126	14.5 x 14.35	14.5 x 17.15	16 x 20 x 1	¾	¾
GAM5B0B30M21EA	30000	51.5 x 21.3 x 21.8	140	18.4 x 14.35	18.4 x 17.15	20 x 20 x 1	¾	¾
GAM5B0B36M31EA	36000	55.7 x 21.3 x 21.8	150	18.4 x 14.35	18.4 x 17.15	20 x 20 x 1	7/8	¾
GAM5B0C42M31EA	42000	56.9 x 23.5 x 21.8	163	20.5 x 14.35	20.5 x 17.15	22 x 20 x 1	7/8	¾
GAM5B0C48M41EA	48000	61.7 x 23.5 x 21.8	176	20.5 x 14.35	20.5 x 17.15	22 x 20 x 1	7/8	¾
GAM5B0C60M51EA	60000	61.7 x 23.5 x 21.8	180	20.5 x 14.35	20.5 x 17.15	22 x 20 x 1	7/8	¾

Table AH-6-B — Features

	GAM5 1 1/2-5
• Efficient cabinet design	✓
– 2% or less air leakage.....	✓
– Precision applied - durable door seals	✓
– Specially designed air seal around refrigerant, condensate and conduit connections	✓
– Double wall foamed cabinet system	✓
– ≥ R-4.2 insulating value.....	✓
– No loose fiber design	✓
– Smooth cleanable interior design	✓
– Sweat eliminating design.....	✓
– Composite cabinet doors	✓
– Water proof cabinet design	✓
– Integrated horizontal drain pans	✓
– Modular cabinet	✓
• Multi-position up/down flow horizontal left/right.....	✓
• UVC light kit with safety switch and polarized plug connections (sold as accessory)	✓
• Side return option (sold as accessory)	✓
• Low voltage pigtail connections	✓
• Vortica® blower with polarized plug connections and integrated slide deck for easy removal	✓
• Aluminum coil with integrated slide deck for easy removal	✓
• Patented enhanced coil fin	✓
• Epoxy coated coil.....	✓
• R-410A TXV	✓
• Slide in electric heaters with polarized plug connections (sold as accessory).....	✓
• Labeled panels and connections	✓
• Molded in 1" standard filter rail	✓
• Direct drive, multi speed ECM blower motor - Constant torque ECM (electronically commutated motor).....	✓
• Maximum width of 23.5"	✓
• Compact 20.8" depth with doors removed.....	✓
• Fused 24v power	✓
• 10-year limited warranty/parts with registration*	✓
• 10-year limited warranty/coil with registration*	✓

* Registered Limited Warranty terms are available when you register within 60 days of installation. You can register online at Trane.com or by phone at 855-260-2975, otherwise Trane's Base Limited Warranty terms will apply. Base Limited Warranty information on specific products can be found on ComfortSite.com.



Hyperion, GAM5 Multi-Position Air Handlers Single Phase 1½-5 Tons

Table AH-7-A — Optional Accessories

Model Number	Description	Matches Cabinet Size(s)	GAM5
BAYWAAA05SC1AA.....	Hydronic Heater, 40,000 BTUH, Nominal, Slide-in, No Control	A	✓
BAYWABB07SC1AA.....	Hydronic Heater, 50,000 BTUH, Nominal, Slide-in, No Control	B	✓
BAYWACC08SC1AA.....	Hydronic Heater, 65,000 BTUH, Nominal, Slide-in, No Control	C	✓
BAYWACC11SC1AA.....	Hydronic Heater, 100,000 BTUH, Nominal, External Top Mount, No Control ^⑦	C	✓
BAYUVCLK001	UV Lights.....		✓
BAYSUPFLGAA	Supply Duct Flange A	A	✓
BAYSUPFLGBA.....	Supply Duct Flange B	B	✓
BAYSUPFLGCA.....	Supply Duct Flange C	C	✓
BAYRETLGAA.....	Return Duct Flange A.....	A	✓
BAYRETLGBA	Return Duct Flange B	B	✓
BAYRETLGCA	Return Duct Flange C	C	✓
BAYFLR1620A	Washable high velocity filter, 16" x 20" x 1" (10 filters)	A	✓
BAYFLR2020A	Washable high velocity filter, 20" x 20" x 1" (10 filters)	B	✓
BAYFLR2220A	Washable high velocity filter, 22" x 20" x 1" (10 filters)	C	✓
TASB175SB ^{②④}	Plenum Stand with Integrated Sound Baffle A.....	A	✓
TASB215SB ^{②④}	Plenum Stand with Integrated Sound Baffle B.....	B	✓
TASB235SB ^{②④}	Plenum Stand with Integrated Sound Baffle C.....	C	✓
MTISRKIT1620 ^②	Side Return Kit with 16"x20" Filter.....	A-C	✓
TASSBK175 ^{③⑤}	Sound Baffle Kit 17.5" Cabinet.....	A	✓
TASSBK215 ^{③⑤}	Sound Baffle Kit 21.5" Cabinet.....	B	✓
TASSBK235 ^{③⑤}	Sound Baffle Kit 23.5" Cabinet.....	C	✓
BAYSPEKT200.....	Single Power Entry Kit		✓
BAYSRKIT100.....	Side Return Kit	A-C	✓
BAYFRKIT175.....	Front Return Kit.....	A	✓
BAYFRKIT210.....	Front Return Kit.....	B	✓
BAYFRKIT235.....	Front Return Kit.....	C	✓
BAYHHKIT001	Horizontal Hanger Kit.....		✓
BAYLVKIT100A	Low Voltage Conduit Entry Kit		✓
BAYAHEMIKIT001	Air handler Electronic Noise Kit used on Variable Speed Blower Motor		✓
BAYBAFKT175A ^⑥	Baffle Kit 17.5" Cabinet.....	A	✓
BAYBAFKT215A ^⑥	Baffle Kit 21.5" Cabinet.....	B	✓
BAYBAFKT235A ^⑥	Baffle Kit 23.5" Cabinet.....	C	✓
BAYCNDPIP01A	3/4" PVC Threaded Pipe Kit with foam seal (10 kits)		✓
Model Number	Description		GAM5B
BAYATXV1836A	R-22 TXV conversion kit		1½-2
BAYATXV4248A	R-22 TXV conversion kit		2½-3½
BAYATXV6060A	R-22 TXV conversion kit		4-5

- ① A Cabinet is 17.5" wide, B Cabinet is 21.5" wide, C Cabinet is 23.5" wide.
- ② Contact your distributor for information.
- ③ In return plenum applications, use TASSBK kits for sound reduction.
- ④ In open air applications, Plenum Stand with Sound Baffle provides sound reduction.
- ⑤ Mounts to TASB original plenum stands without integrated sound baffle.
- ⑥ Mounts inside air filter channel on air handler.
- ⑦ TCONT900 Thermostat can not be used with Hydronic heating.



It's Hard To Stop A Trane.®

Heaters for Hyperion Multi-Position Air Handlers

Table AH-8-A – BAYEA – Heater, Standard, for Hyperion TAMX, TAM9, and GAM5 Air Handlers

Heater Model Number	Capacity @ 240 Volts		Capacity @ 208 Volts		Rated Voltage	Control Stages	Number of Heater Racks	Number of Circuits	Heater Amps per Circuit		Contains Circuit Breakers
	kW	BTUH	kW	BTUH					208 Volts	240Volt	
BAYEAAC04BK1BB	3.84	13100	2.88	9800	208/240/1/60	1	1	1	13.8	16	Yes
BAYEAAC04LG1BB	3.84	13100	2.88	9800	208/240/1/60	1	1	1	13.8	16	No
BAYEAAC05BK1BB	4.80	16400	3.60	12300	208/240/1/60	1	1	1	17.3	20	Yes
BAYEAAC05LG1BB	4.80	16400	3.60	12300	208/240/1/60	1	1	1	17.3	20	No
BAYEAAC08BK1BB	7.68	26200	5.76	19700	208/240/1/60	2	2	1	27.7	32	Yes
BAYEAAC08LG1BB	7.68	26200	5.76	19700	208/240/1/60	2	2	1	27.7	32	No
BAYEAAC10BK1BB	9.60	32800	7.20	24600	208/240/1/60	2	2	1	34.6	40	Yes
BAYEAAC10LG1BB	9.60	32800	7.20	24600	208/240/1/60	2	2	1	34.6	40	No
BAYEABC15BK1BB	14.40	49200	10.80	36900	208/240/1/60	3	3	2	34.6/17.3	40/20	Yes
BAYEABC20BK1BB	19.20	65600	14.40	49200	208/240/1/60	3	4	2	34.6/34.6	40/40	Yes
BAYEACC25BK1BB	24.00	82000	18.00	61500	208/240/1/60	3	5	3	34.6/34.6/17.3	40/40/20	Yes

BK = Contains circuit breakers
 LG = Contains lug connections

Table AH-8-B – BAYEA – Heater, 3-Phase, for Hyperion TAM9 and GAM5 Air Handlers ①

Heater Model Number	Capacity @ 240 Volts		Capacity @ 208 Volts		Rated Voltage	Control Stages	Number of Heater Racks	Number of Circuits	Heater Amps per Circuit		Contains Circuit Breakers
	kW	BTUH	kW	BTUH					208 Volts	240Volt	
BAYEAAC10LG3BB	9.60	32800	7.20	24600	208/240/3/60	1	3	1	20.0	23.1	No
BAYEABC15LG3BB	14.40	49200	10.80	36900	208/240/3/60	1	3	1	30.0	34.6	No

① 3-Phase - W1, W2, W3 must be jumpered at low voltage connector



It's Hard To Stop A Trane.®

Heaters for Multi-Position Air Handlers

Table AH-9-A – Air Handler/Heater Matrix

AIR HANDLER	HEATER MODEL NUMBER BAYEA-										
MODEL NUMBER	AC04BK1BB 3.84 Kw BK	AC04LG1BB 3.84 Kw LG	AC05BK1BB 4.80 Kw BK	AC05LG1BB 4.80 Kw LG	AC08BK1BB 7.68 Kw BK	AC08LG1BB 7.68 Kw LG	AC10BK1BB 9.60 Kw BK	AC10LG1BB 9.60 Kw LG	BC15BK1BB 14.40 Kw BK	BC20BK1BB 19.20 Kw BK	CC25BK1BB 24.00 Kw BK
TAM9A0A24V21 / TAMXB0A24V21	Y	Y	Y	Y	Y	Y	Y	Y	—	—	—
TAM9A0B30V31 / TAMXB0B30V31	Y	Y	Y	Y	Y	Y	Y	Y	Y	—	—
TAM9A0C36V31 / TAMXB0C36V31	Y	Y	Y	Y	Y	Y	Y	Y	Y	Y	—
TAM9A0C42V41 / TAMXB0C42V41	Y	Y	Y	Y	Y	Y	Y	Y	Y	Y	—
TAM9A0C48V41 / TAMXB0C48V41	Y	Y	Y	Y	Y	Y	Y	Y	Y	Y	Y
TAM9A0C60V51 / TAMXB0C60V51	Y	Y	Y	Y	Y	Y	Y	Y	Y	Y	Y
GAM5B0A18M11	Y	Y	Y	Y	Y	Y	Y	Y	—	—	—
GAM5B0A24M21	Y	Y	Y	Y	Y	Y	Y	Y	—	—	—
GAM5B0B30M21	Y	Y	Y	Y	Y	Y	Y	Y	Y	—	—
GAM5B0B36M31	Y	Y	Y	Y	Y	Y	Y	Y	Y	—	—
GAM5B0C42M31	Y	Y	Y	Y	Y	Y	Y	Y	Y	—	—
GAM5B0C48M41	Y	Y	Y	Y	Y	Y	Y	Y	Y	Y	Y
GAM5B0C60M51	Y	Y	Y	Y	Y	Y	Y	Y	Y	Y	Y

BK = Contains circuit breakers
LG = Contains lug connections

Table AH-9-B – Air Handler/Heater Matrix (continued)

AIR HANDLER	3 PHASE HEATER MODEL NUMBER BAYEA-	
MODEL NUMBER	AC10LG3BB 9.60 Kw LG	BC15LG3BB 9.60 Kw LG
TAM9A0A24V21 / TAMXB0A24V21	Y	—
TAM9A0B30V31 / TAMXB0B30V31	Y	Y
TAM9A0C36V31 / TAMXB0C36V31	Y	Y
TAM9A0C42V41 / TAMXB0C42V41	Y	Y
TAM9A0C48V41 / TAMXB0C48V41	Y	Y
TAM9A0C60V51 / TAMXB0C60V51	Y	Y
GAM5B0A18M11	Y	—
GAM5B0A24M21	Y	—
GAM5B0B30M21	Y	Y
GAM5B0B36M31	Y	Y
GAM5B0C42M31	Y	Y
GAM5B0C48M41	Y	Y
GAM5B0C60M51	Y	Y

LG = Contains lug connections

TEM Split System Air Handlers Single Phase 1½-5 Tons

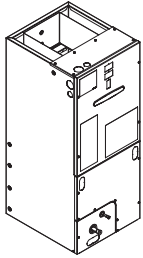

Table AH-10-A — R-410A ComfortLink™ II or 24V Variable Speed Air Handler 208-230/1/60

Model Number	Cooling Capacity (Btuh)	Dimensions (in.) H x W x D	Shipping Weight (lbs.)	Supply Opening	Return Opening	Filter Sizes	Line Size (in)	
							Gas	Liquid
TEM8A0B24V21DC	24000	46.75 x 18.5 x 21.13	126	16.5 x 12.15	16.75 x 18.75	①	¾	⅜
TEM8A0B30V31DC	30000	46.75 x 18.5 x 21.13	126	16.5 x 12.15	16.75 x 18.75	①	¾	⅜
TEM8A0C36V31DC	36000	51.27 x 23.5 x 21.13	155	21.5 x 12.15	21.75 x 18.75	①	7/8	⅜
TEM8A0C42V41DC	42000	51.27 x 23.5 x 21.13	155	21.5 x 12.15	21.75 x 18.75	①	7/8	⅜
TEM8A0C48V41DC	48000	57.38 x 23.5 x 21.13	185	21.5 x 12.15	21.75 x 18.75	①	7/8	⅜
TEM8B0C60V51DA	60000	57.38 x 23.5 x 21.13	185	21.5 x 12.15	21.75 x 18.75	①	7/8	⅜

① Filter not supplied. Remote filter required.

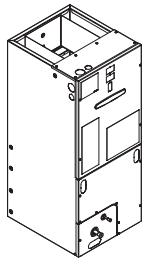

Table AH-10-B — R-410A Convertible Variable Speed Air Handler 208-230/1/60

Model Number	Cooling Capacity (Btuh)	Dimensions (in.) H x W x D	Shipping Weight (lbs.)	Supply Opening	Return Opening	Filter Sizes	Line Size (in)	
							Gas	Liquid
TEM6A0B24H21SC	24000	46.75 x 18.5 x 21.13	126	16.5 x 12.15	16.75 x 18.75	①	¾	⅜
TEM6A0B30H21SC	30000	46.75 x 18.5 x 21.13	126	16.5 x 12.15	16.75 x 18.75	①	¾	⅜
TEM6A0C36H31SC	36000	51.27 x 23.5 x 21.13	155	21.5 x 12.15	21.75 x 18.75	①	7/8	⅜
TEM6A0C42H41SC	42000	51.27 x 23.5 x 21.13	155	21.5 x 12.15	21.75 x 18.75	①	7/8	⅜
TEM6A0C48H41SC	48000	57.38 x 23.5 x 21.13	185	21.5 x 12.15	21.75 x 18.75	①	7/8	⅜
TEM6B0C60H51SA	60000	57.38 x 23.5 x 21.13	185	21.5 x 12.15	21.75 x 18.75	①	7/8	⅜

① Filter not supplied. Remote filter required.

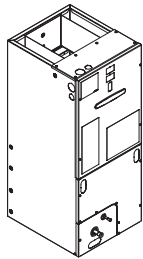

Table AH-10-C — R-410A Convertible Air Handler 208-230/1/60

Model Number	Cooling Capacity (Btuh)	Dimensions (in.) H x W x D	Shipping Weight (lbs.)	Supply Opening	Return Opening	Filter Sizes	Line Size (in)	
							Gas	Liquid
TEM4B0B24M21SA	24000	45.02 x 18.5 x 21.13	116	16.5 x 12.15	16.75 x 18.75	①	¾	⅜
TEM4A0B31M31SB	30000	46.75 x 18.5 x 21.13	145	16.5 x 12.15	16.75 x 18.75	①	¾	⅜
TEM4B0C37M31SA	36000	51.27 x 23.5 x 21.13	155	21.5 x 12.15	21.75 x 18.75	①	7/8	⅜
TEM4A0C42S41SC②	42000	51.27 x 23.5 x 21.13	145	21.5 x 12.15	21.75 x 18.75	①	7/8	⅜
TEM4A0C43M41SB	42000	51.27 x 23.5 x 21.13	155	21.5 x 12.15	21.75 x 18.75	①	7/8	⅜
TEM4A0C48S41SC②	48000	51.27 x 23.5 x 21.13	145	21.5 x 12.15	21.75 x 18.75	①	7/8	⅜
TEM4A0C49M41SB	48000	57.38 x 23.5 x 21.13	185	21.5 x 12.15	21.75 x 18.75	①	7/8	⅜
TEM4B0C60S51SA	60000	57.38 x 23.5 x 21.13	185	21.5 x 12.15	21.75 x 18.75	①	7/8	⅜

① Filter not supplied. Remote filter required.

② AC only

TEM Split System Air Handlers Single Phase 1½-5 Tons

Table AH-11-A — Features

	TEM8 2-5	TEM6 2-5	TEM4 2-5
• ComfortLink™ II or 24V operation.....	✓	—	—
• Direct drive, variable speed ECM blower motor - Constant airflow ECM (electronically commutated).....	✓	✓	—
• Direct drive, multi speed ECM blower motor - Constant torque ECM (electronically commutated motor).....	—	—	✓
• R-4.2 Insulating Value	✓	✓	✓
• Multi-Position UP/Down Flow, Horizontal Left /Right.....	✓	✓	✓
• All Aluminum Coil with Enhanced Patented Coil Fin	✓	✓	✓
• Electric Heaters with polarized plug connections (sold as accessory)	✓	✓	✓
• R-410A Thermal Expansion Valve	✓	✓	✓
• Low Voltage Pigtail Connections	✓	✓	✓
• Draw Through Design	✓	✓	✓
• Horizontal Drain pan	✓	✓	✓
• Single Color	✓	✓	✓
• Fused 24V Power	✓	✓	✓
• Wipeable interior design.....	✓	✓	✓
• Soft start fan motor operation.....	✓	✓	—
• Comfort R™ mode.....	✓	✓	—
• Painted metal cabinet with captured foil face insulation.....	✓	✓	✓
• 2% or less air leakage	✓	✓	✓
• Built in fan delay modes	✓	✓	—
• Maximum Width 23.5"	✓	✓	✓
• Compact 22" depth	✓	✓	✓
• Draw through design.....	✓	✓	✓
• 10-year limited warranty/parts with registration*	✓	✓	✓
• 10-year limited warranty/coil with registration*	✓	✓	✓

* Registered Limited Warranty terms are available when you register within 60 days of installation. You can register online at Trane.com or by phone at 855-260-2975, otherwise Trane's Base Limited Warranty terms will apply. Base Limited Warranty information on specific products can be found on ComfortSite.com.

Table AH-11-B — Optional Accessories

Model Number	Description	Matches Cabinet Size(s)	TEM8	TEM6	TEM4
BAYTEMSPFG1	Supply Duct Flange Kit		✓	✓	✓
BAYSPEKT201A	Single Point Power Entry Kit		✓	✓	✓
TAYBASE185.....	Air Handler Downflow Sub-Bases.....	18.5"	✓	✓	✓
TAYBASE235 (TAYBASE100)	Air Handler Downflow Sub-Bases.....	23.5"	✓	✓	✓
TAYBASE102.....	Air Handler Downflow Sub-Bases.....	26.5"	✓	✓	—
BAYTEMDFKT1A.....	Downflow Condensate Management Kit.....	23.5" ①.....	—	—	✓
BAYAHEMIKIT001	Air handler Electronic Noise Kit used on Variable Speed Blower Motor		✓	✓	✓
TEMBRKSEALKT01A	TEM Breaker Seal Kit.....		✓	✓	✓
BAYSF1185AAA.....	Slim Fit Filter Box Kit	18.5"	✓	✓	✓
BAYSF1235AAA.....	Slim Fit Filter Box Kit	23.5"	✓	✓	✓
BAYSF1265AAA.....	Slim Fit Filter Box Kit	26.5"	✓	✓	—
FLRSF1185	1" Slim Fit Replacement Filter, 17.75"x19.75", Qty 12	18.5"	✓	✓	✓
FLRSF1235	1" Slim Fit Replacement Filter, 22.75"x19.75", Qty 12	23.5"	✓	✓	✓
FLRSF1265	1" Slim Fit Replacement Filter, 25.75"x19.75", Qty 12	26.5"	✓	✓	—
BAY6TXV2442A	R-22 TXV conversion kit		2-3½	2-3½	—
BAYATXV1836B	R-22 TXV conversion kit		—	—	1½-2½
BAYATXV4248B	R-22 TXV conversion kit		—	—	3-4
BAYATXV6161B	R-22 TXV conversion kit		4-5②	4-5②	5

① Downflow condensate management kit is required for 5 Ton downflow models.

② TEM6A0D48, TEM6A0D60, TEM8A0D48, TEM8A0D60



It's Hard To Stop A Trane.®

Heaters for TEM Split System Air Handlers

Table AH-12-A – BAYHTR15 – Heater, Standard, for TEM Air Handlers

Heater Model Number	Capacity @ 240 Volts		Capacity @ 208 Volts		Rated Control	Voltage Stages	Number of Heater Racks	Number of Circuits	Heater Amps per Circuit		Contains Circuit Breakers
	kW	BTUH	kW	BTUH					208 Volts	240 Volts	
BAYHTR1504BRKC	3.84	13100	2.88	9800	208/240/1/60	1	1	1	13.8	16	Yes
BAYHTR1504LUGB	3.84	13100	2.88	9800	208/240/1/60	1	1	1	13.8	16	No
BAYHTR1505BRKC	4.80	16400	3.60	12300	208/240/1/60	1	1	1	17.3	20	Yes
BAYHTR1505LUGB	4.80	16400	3.60	12300	208/240/1/60	1	1	1	17.3	20	No
BAYHTR1508BRKC	7.68	26200	5.76	19700	208/240/1/60	1	1	1	27.7	32	Yes
BAYHTR1508LUGB	7.68	26200	5.76	19700	208/240/1/60	1	1	1	27.7	32	No
BAYHTR1510BRKC	9.60	32800	7.20	24600	208/240/1/60	1	2	1	34.6	40	Yes
BAYHTR1510LUGB	9.60	32800	7.20	24600	208/240/1/60	1	2	1	34.6	40	No
BAYHTR1517BRKA	14.4	49200	10.8	36900	208/240/1/60	2	3	2	51.9	60	Yes
BAYHTR1520BRKB	19.2	65500	14.4	49200	208/240/1/60	2	4	2	69.2	80	Yes
BAYHTR1523BRKA	19.2	65500	14.4	49200	208/240/1/60	2	4	2	69.2	80	Yes
BAYHTR1525BRKA	24.0	81900	18.0	61600	208/240/1/60	2	4	2	86.4	100	Yes

Table AH-12-B – BAYHTR35 – Heater, 3-Phase, for TEM Air Handlers ①

Heater Model Number	Capacity @ 240 Volts		Capacity @ 208 Volts		Rated Control	Voltage Stages	Number of Heater Racks	Number of Circuits	Heater Amps per Circuit		Contains Circuit Breakers
	kW	BTUH	kW	BTUH					208 Volts	240 Volts	
BAYHTR3510LUGC	9.60	32800	7.20	24600	208/240/3/60	1	3	1	20.0	23.1	No
BAYHTR3515LUGC	14.4	49200	10.8	36900	208/240/3/60	1	3	1	30.0	34.6	No
BAYHTR3517LUGA	14.4	49200	10.8	36900	208/240/3/60	1	3	1	30.0	34.6	No

BRK = Contains circuit breakers

LUG = Lug connections

① 3-Phase - W1 and W2 must be jumpered at low voltage connector

Heater Matches for TEM Split System Air Handlers with metal blower housing

Table AH-13-A – TEM8 and TEM6 Air Handler and Heater matches

TEM6/TEM8 HEATER MATRIX									
AIR HANDLER	HEATER MODEL NUMBER								
MODEL NUMBER	BAYHTR1504BRKC BAYHTR1504LUGB 3.84 Kw	BAYHTR1505BRKC BAYHTR1505LUGB 4.80 Kw	BAYHTR1508BRKC BAYHTR1508LUGB 7.68 Kw	BAYHTR1510BRKC BAYHTR1510LUGB 9.60 Kw	BAYHTR1517BRKA 14.40 Kw	BAYHTR1523BRKA 19.20 Kw	BAYHTR1525BRKA 24.00 Kw	BAYHTR3510LUGC 9.60 Kw	BAYHTR3517LUGA 14.40 Kw
TEM8A0B24V21DC TEM8A0B30V31DC TEM6A0B24H21SC TEM6A0B30H21SC	Y	Y	Y	Y	Y	-	-	Y	Y
TEM8A0C36V31DC TEM8A0C42V41DC TEM6A0C36H31SC TEM6A0C42H41SC	Y	Y	Y	Y	Y	Y	-	Y	Y
TEM8A0C48V41DC TEM8B0C60V51DA TEM6A0C48H41SC TEM6B0C60H51SA	Y	Y	Y	Y	Y	Y	Y	Y	Y

Table AH-13-B – TEM4 Air Handler and Heater matches

TEM4 HEATER MATRIX					
AIR HANDLER	HEATER MODEL NUMBER				
MODEL NUMBER	"BAYHTR1504BRKC BAYHTR1504LUGB 3.84 Kw BK BAYHTR1505BRKC BAYHTR1505LUGB 4.80 Kw BK"	"BAYHTD1508BRKC BAYHTR1508LUGB 7.68 Kw BK BAYHTR1510BRKC BAYHTR1510LUGB BAYHTR3510LUGC 9.60 Kw BK"	"BAYHTR1517BRKA BAYHTR3517LUGA 14.40 Kw BK"	"BAYHTR1523BRKA 19.20 Kw BK"	"BAYHTR1525BRKA 24.00 Kw BK"
TEM4A0B18S21SC	Y	Y	-	-	-
TEM4A0B24S21SC	Y	Y	-	-	-
TEM4A0B30S31SC	Y	Y	Y	-	-
TEM4A0B36S31SC	Y	Y	Y	-	-
TEM4A0C37S31SC	Y	Y	Y	Y	-
TEM4A0C42S41SC	Y	Y	Y	Y	-
TEM4A0C48S41SC	Y	PHYSING OUT	Y	Y	Y
TEM4A0C60S51SC	Y	Y	Y	Y	Y
TEM4A0B19M21SA	Y	Y	-	-	-
TEM4A0B31M31SB	Y	Y	Y	-	-
TEM4A0C43M41SA	Y	Y	Y	Y	-
TEM4A0C49M41SB	Y	Y	Y	Y	Y
TEM4A0C61M51SB	Y	Y	Y	Y	Y
TEM4B0B24M21SA	Y	Y	-	-	-
TEM4A0B31M31SB	Y	Y	Y	-	-
TEM4B0C37M31SA	Y	Y	Y	Y	-
TEM4A0C42S41SC	Y	Y	Y	Y	-
TEM4A0C43M41SB	Y	Y	Y	Y	-
TEM4A0C48S41SC	Y	Y	Y	Y	Y
TEM4A0C49M41SB	Y	Y	Y	Y	Y
TEM4B0C60S51SA	Y	Y	Y	Y	Y

For complete equipment / combination selections, installation instructions and warranty information, please refer to Product Data/Ratings and/or Installers Guides and Limited Warranty Handbooks.



TMM Wall, Stud, or Over the Water Heater Mount Air Handlers Single Phase 1½-3 Tons

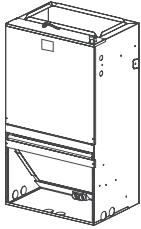

Table AH-14-A — TMM5 R-410A Wall, Stud, or Over the Water Heater Mount Air Handler 208-230/1/60, ECM Motor, Factory installed R-410A TXV, all aluminum coil, Cooling & Limited Heating

Unit Model No.	Cooling Capacity (Btuh)	Dimensions (in.) H x W x D	Shipping Weight (lbs.)	Supply Opening	Filter Sizes	Line Size	
						Gas	Liquid
TMM5B0A24M21SA	24000	36.5 x 20.5 x 15.0	93	15 x 9.5	①	3/4	3/8
TMM5B0B30M21SA	30000	39.5 x 22.0 x 19.0	115	19 x 9.5	①	3/4	3/8
TMM5B0B36M31SA	36000	39.5 x 22.0 x 19.0	115	19 x 9.5	①	3/4	3/8

Table AH-14-B — TMM4 R-410A Wall, Stud, or Over the Water Heater Mount Air Handler 208-230/1/60, PSC Motor, Factory installed R-410A orifice, all aluminum coil, Cooling & Heating

Unit Model No.	Cooling Capacity (Btuh)	Dimensions (in.) H x W x D	Shipping Weight (lbs.)	Supply Opening	Filter Sizes	Line Size	
						Gas	Liquid
TMM4B0A18S21SA	18000	36.5 x 20.5 x 15.0	97	15 x 9.5	①	3/4	3/8
TMM4B0A24S21SA	24000	36.5 x 20.5 x 15.0	97	15 x 9.5	①	3/4	3/8
TMM4B0B30S21SA	30000	39.5 x 22.0 x 19.0	119	19 x 9.5	①	3/4	3/8
TMM4B0B36S31SA	36000	39.5 x 22.0 x 19.0	119	19 x 9.5	①	3/4	3/8

① Filter not supplied. Remote filter required.

Table AH-14-C — Features

	TMM5B 2-3	TMM4B 1-1/2-3
• Painted metal cabinet with captured foil face insulation.....	✓	✓
• 2% or less air leakage	✓	✓
• All aluminum coil	✓	✓
• Direct drive, multi speed ECM blower motor - Constant torque ECM (electronically commutated motor) with fan-off time delay programming.....	✓	—
• PSC Motor.....	—	✓
• Limited HP matched system ratings	—	✓
• R-4.2 Insulating Value	✓	✓
• Upflow only	✓	✓
• Front return option	✓	✓
• High Efficiency Copper / Aluminum Coil.....	✓	✓
• Electric Heaters with polarized plug connections (sold as accessory)	✓	✓
• R-410A Thermal Expansion Valve	✓	—
• Low Voltage Pigtail Connections	✓	✓
• Single Color	✓	✓
• Fused 24V Power	✓	✓
• Wipeable interior design.....	✓	✓
• Maximum Height 39.5".....	✓	✓
• Maximum Width 22".....	✓	✓
• Compact 22" depth.....	✓	✓
• Optional R-22 and R-410A TXV kits (sold as accessory)	✓	✓
• 10-year limited warranty/parts with registration*	✓	✓
• 10-year limited warranty/coil with registration*	✓	✓

* Registered Limited Warranty terms are available when you register within 60 days of installation. You can register online at Trane.com or by phone at 855-260-2975, otherwise Trane's Base Limited Warranty terms will apply. Base Limited Warranty information on specific products can be found on ComfortSite.com.



TMM Wall, Stud, or Over the Water Heater Mount Air Handlers Single Phase 1½-3 Tons

Table AH-15-A – Optional Accessories

Model Number	Description	TMM5B	TMM4B
4AYTXVH3G2436A	R-410A TXV kit 1-1/2 to 3 ton	—	✓
2AYTXVH3G2436A	R-22 TXV conversion kit 1-1/2 to 3 ton	✓	✓
BAYFRTLLOUPNL20	Front louver panel 20.5" width	—	✓
BAYFRTLLOUPNL22	Front louver panel 22.0" width	✓	✓
BAYTMMWALLPNL1	Return air / service wall panel (Qty 20)	✓	✓

Heaters for TMM Split System Air Handlers

Table AH-15-B – BAYHTRM – Heater, Standard, for TMM Air Handlers

Heater Model Number	Capacity @ 240 Volts		Capacity @ 208 Volts		Rated Control	Voltage Stages	Number of Heater Racks	Number of Circuits	Heater Amps per Circuit		Contains Circuit Breakers
	kW	BTUH	kW	BTUH					208 Volts	240 Volts	
BAYHTRM505BRK	5.0	17100	3.8	12800	208/240/1/60	1	1	1	18	20.8	Yes
BAYHTRM508BRK	7.5	25600	5.6	19200	208/240/1/60	1	1	1	27.1	31.2	Yes
BAYHTRM510BRK	10.0	34100	7.5	25600	208/240/1/60	1	2	1	36.1	41.7	Yes

P-Series Modular Blower - Variable Speed



POVO

Table FUR-16-A — P-Series Modular Blower - Variable Speed

Model Number	Nominal Airflow (Tons)	Blower Motor	Uncrated Dimensions (in.)			Shipping Weight (lbs.)	Max. Fuse	Filter** Sizes
			H	W	D			
P0V0A000M30SC	3	VS ^①	34	14.5	28.75	83	15	14 x 25 x 1
P0V0B000M40SC	4	VS ^①	34	17.5	28.75	92	15	16 x 25 x 1
P0V0C000M50SC	5	VS ^①	34	21	28.75	101	15	20 x 25 x 1
P0V0D000M50SC	5	VS ^①	34	24.5	28.75	107	15	24 x 25 x 1

Table FUR-16-B — Features

	POVO
• 34 Inch Cabinet Height.....	✓
• High efficiency, variable speed blower motor.....	✓
• Vortica™ II blower housing design.....	✓
• Fully insulated cabinet ②.....	✓
• 4-way multi-poise	✓
• Painted cabinet with two tone color.....	✓
• Cabinet is certified to less than 1% leakage.....	✓
• Matches industry standard furnace widths (14.5", 17.5", 21", 24.5").....	✓
• 120V wiring connections.....	✓
• Entirely electric operation	✓
• Service diagnostic capabilities	✓
• Dry contact humidifier/EAC terminals.....	✓
• 10-year limited warranty on all functional parts with registration ^③	✓

① Variable Speed

② 14.5" models do not have blower compartment insulation

③ Registered Limited Warranty terms are available when you register within 60 days of installation. You can register online at Trane.com or by phone at 855-260-2975, otherwise Trane's Base Limited Warranty terms will apply. Base Limited Warranty information on specific products can be found on ComfortSite.com.

** Filters are not shipped with modular blower.

Split System – Cased Heat Pump and Cooling Coils



**4TXC
Comfort™ Coil**

Table COIL-1-A – Aluminum High Efficiency Staged System Cased Convertible Coils (Upflow/ Downflow/ Horizontal Left or Right) R-410A Refrigerant

Model Number	Cooling Capacity Range (Tons)	Coil Type	Refrigerant Control	Outlet Dim. (in.) W/H x D	OverallDim. (in.) H x W x D	Shipping Weight (lbs.)	Line Size OD Gas	OD Liq.
4TXCA002DS3HCA	1.5 - 2.5	A	TXVNB①	12 ³ / ₄ x 19 ³ / ₈	17.5 x 14.5 x 21.5	42	3/4	3/8
4TXCA032DS3HCA	1.5 - 3.0	A	TXVNB①	12 ³ / ₄ x 19 ³ / ₈	22.5 x 14.5 x 21.5	46	3/4	3/8
4TXCB003DS3HCA	1.5 - 4.0	A	TXVNB①	15 ³ / ₄ x 19 ³ / ₈	17.5 x 17.5 x 21.5	50	3/4	3/8
4TXCB004DS3HCB	1.5 - 4.0	A	TXVNB①	15 ³ / ₄ x 19 ³ / ₈	22.5 x 17.5 x 21.5	58	7/8	3/8
4TXCC005DS3HCA	1.5 - 4.0	A	TXVNB①	19 ¹ / ₄ x 19 ³ / ₈	22.5 x 21 x 21.5	60	7/8	3/8
4TXCB006DS3HCA	2.0 - 4.0	A	TXVNB①	15 ³ / ₄ x 19 ³ / ₈	26.9 x 17.5 x 21.5	65	7/8	3/8
4TXCC007DS3HCA	2.0 - 5.0	A	TXVNB①	19 ¹ / ₄ x 19 ³ / ₈	26.9 x 21 x 21.5	69	7/8	3/8
4TXCD008DS3HCA	2.0 - 5.0	A	TXVNB①	22 ³ / ₄ x 19 ³ / ₈	26.9 x 24.5 x 21.5	72	7/8	3/8
4TXCC009DS3HCA	3.0 - 5.0	A	TXVNB①	19 ¹ / ₄ x 19 ³ / ₈	30.7 x 21 x 21.5	78	7/8	3/8
4TXCD010DS3HCA	3.0 - 5.0	A	TXVNB①	22 ³ / ₄ x 19 ³ / ₈	30.7 x 24.5 x 21.5	81	7/8	3/8



**4PXC-U
Comfort™ Coil**

Table COIL-1-B – Aluminum High Efficiency Staged System Cased Upflow/Downflow Coils R-410A Refrigerant, Convertible to Horizontal Left or Horizontal Right with kit

Model Number	Cooling Capacity Range (Tons)	Coil Type	Refrigerant Control	Outlet Dim. (in.) W/H x D	OverallDim. (in.) H x W x D	Shipping Weight (lbs.)	Line Size OD Gas	OD Liq.
4PXCAU24BS3HAA	1.5 - 2.5	A	TXVNB①	12 ³ / ₄ x 19 ³ / ₈	17.5 x 14.5 x 21.5	39	3/4	3/8
4PXCBU24BS3HAA	1.5 - 2.5	A	TXVNB①	15 ³ / ₄ x 19 ³ / ₈	17.5 x 17.5 x 21.5	42	3/4	3/8
4PXCAU32BS3HAA	1.5 - 3.0	A	TXVNB①	12 ³ / ₄ x 19 ³ / ₈	22.5 x 14.5 x 21.5	43	3/4	3/8
4PXCBU30BS3HAA	1.5 - 4.0	A	TXVNB①	15 ³ / ₄ x 19 ³ / ₈	17.5 x 17.5 x 21.5	47	3/4	3/8
4PXCCU30BS3HAA	1.5 - 4.0	A	TXVNB①	19 ¹ / ₄ x 19 ³ / ₈	17.5 x 21 x 21.5	49	3/4	3/8
4PXCBU36BS3HAB	1.5 - 4.0	A	TXVNB①	15 ³ / ₄ x 19 ³ / ₈	22.5 x 17.5 x 21.5	54	7/8	3/8
4PXCCU36BS3HAA	1.5 - 4.0	A	TXVNB①	19 ¹ / ₄ x 19 ³ / ₈	22.5 x 21 x 21.5	56	7/8	3/8
4PXCBU42BS3HAA	1.5 - 4.0	A	TXVNB①	15 ³ / ₄ x 19 ³ / ₈	26.9 x 17.5 x 21.5	61	7/8	3/8
4PXCCU42BS3HAA	1.5 - 4.0	A	TXVNB①	19 ¹ / ₄ x 19 ³ / ₈	26.9 x 21 x 21.5	64	7/8	3/8
4PXCBU48BS3HAA	2.0 - 4.0	A	TXVNB①	15 ³ / ₄ x 19 ³ / ₈	26.9 x 17.5 x 21.5	61	7/8	3/8
4PXCCU48BS3HAA	2.0 - 5.0	A	TXVNB①	19 ¹ / ₄ x 19 ³ / ₈	26.9 x 21 x 21.5	64	7/8	3/8
4PXCDU48BS3HAA	2.0 - 5.0	A	TXVNB①	22 ³ / ₄ x 19 ³ / ₈	26.9 x 24.5 x 21.5	68	7/8	3/8
4PXCCU60BS3HAA	3.0 - 5.0	A	TXVNB①	19 ¹ / ₄ x 19 ³ / ₈	30.7 x 21 x 21.5	73	7/8	3/8
4PXCDD60BS3HAA	3.0 - 5.0	A	TXVNB①	22 ³ / ₄ x 19 ³ / ₈	30.7 x 24.5 x 21.5	77	7/8	3/8



**4PXC-D
Comfort™ Coil**

Table COIL-1-C – Aluminum High Efficiency Staged System Cased Downflow Coils R-410A Refrigerant, Convertible to Horizontal Right with kit

Model Number	Cooling Capacity Range (Tons)	Coil Type	Refrigerant Control	Outlet Dim. (in.) W/H x D	OverallDim. (in.) H x W x D	Shipping Weight (lbs.)	Line Size OD Gas	OD Liq.
4PXCBD30BS3HDA	1.5 - 4.0	A	TXVNB①	15 ³ / ₄ x 19 ³ / ₈	17.5 x 17.5 x 21.5	47	3/4	3/8
4PXCBD36BS3HDA	1.5 - 4.0	A	TXVNB①	15 ³ / ₄ x 19 ³ / ₈	22.5 x 17.5 x 21.5	54	7/8	3/8
4PXCCD36BS3HDA	1.5 - 4.0	A	TXVNB①	19 ¹ / ₄ x 19 ³ / ₈	22.5 x 21 x 21.5	56	7/8	3/8
4PXCBD42BS3HDA	1.5 - 4.0	A	TXVNB①	15 ³ / ₄ x 19 ³ / ₈	26.9 x 17.5 x 21.5	61	7/8	3/8
4PXCCD42BS3HDA	1.5 - 4.0	A	TXVNB①	19 ¹ / ₄ x 19 ³ / ₈	26.9 x 21 x 21.5	64	7/8	3/8
4PXCCD60BS3HDA	3.0 - 5.0	A	TXVNB①	19 ¹ / ₄ x 19 ³ / ₈	30.7 x 21 x 21.5	73	7/8	3/8
4PXCDD60BS3HDA	3.0 - 5.0	A	TXVNB①	22 ³ / ₄ x 19 ³ / ₈	30.7 x 24.5 x 21.5	77	7/8	3/8

① Start Kit may be required on outdoor unit.



It's Hard To Stop A Trane.®

Coils

Split System – Uncased Heat Pump and Cooling Coils

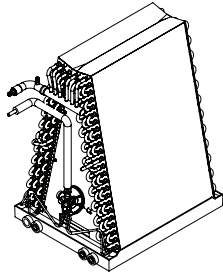

4AXA Comfort™ Coil

Table COIL-2-A – Aluminum Uncased Upflow Coils R-410A Refrigerant

Model Number	Cooling Capacity Range (Tons)	Coil Type	Refrigerant Control	Overall Dim. (in.) H x W x D	Shipping Weight (lbs.)	Line Size	
						OD Gas	OD Liq.
4AXAA001BS3HAA	1.5-2	A	TXVNB	13 x 13 x 19¼	11	¾	¾
4AXAB002BS3HAA	1.5-2	A	TXVNB	13 x 16 x 19¼	11	¾	¾
4AXAA003BS3HAA	1.5-2.5	A	TXVNB	15 x 13 x 19¼	18	¾	¾
4AXAB004BS3HAA	1.5-2.5	A	TXVNB	15 x 16 x 19¼	18	¾	¾
4AXAA005BS3HAA	1.5-3	A	TXVNB	17 x 13 x 19¼	22	¾	¾
4AXAB006BS3HAA	1.5-3	A	TXVNB	17 x 16 x 19¼	22	¾	¾
4AXAB007BS3HAA	2 - 3	A	TXVNB	21 x 16 x 19¼	27	¾	¾
4AXAB008BS3HAA	3 - 4	A	TXVNB	25 x 16 x 19¼	32	7/8	¾
4AXAC009BS3HAA	3 - 4	A	TXVNB	25 x 19½ x 19¼	32	7/8	¾
4AXAB010BS3HAA	3 - 5	A	TXVNB	27 x 16 x 19¼	35	7/8	¾
4AXAC011BS3HAA	3 - 5	A	TXVNB	27 x 19½ x 19¼	35	7/8	¾
4AXAD012BS3HAA	3 - 5	A	TXVNB	27 x 23 x 19¼	35	7/8	¾

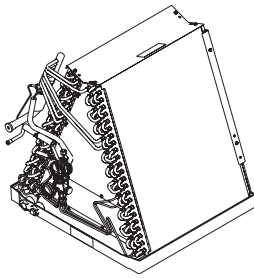

4PXA Comfort™ Coil

Table COIL-2-B – Aluminum Uncased Upflow Coils R-410A Refrigerant

Model Number	Cooling Capacity Range (Tons)	Coil Type	Refrigerant Control	Overall Dim. (in.) H x W x D	Shipping Weight (lbs.)	Line Size	
						OD Gas	OD Liq.
4PXAAU24BS3HAA	1.5 - 2.5	A	TXVNB ^①	14.7 x 13.3 x 21.1	24	¾	¾
4PXABU24BS3HAA	1.5 - 2.5	A	TXVNB ^①	14.5 x 16.3 x 21.1	24	¾	¾
4PXABU30BS3HAA	1.5 - 4.0	A	TXVNB ^①	15.8 x 16.3 x 21.1	32	¾	¾
4PXACU30BS3HAA	1.5 - 4.0	A	TXVNB ^①	15.8 x 19.8 x 21.1	32	¾	¾
4PXABU36BS3HAA	1.5 - 4.0	A	TXVNB ^①	21.2 x 16.3 x 21.1	33	7/8	¾
4PXACU36BS3HAA	1.5 - 4.0	A	TXVNB ^①	20.8 x 19.8 x 21.1	32	7/8	¾
4PXABU42BS3HAA	1.5 - 4.0	A	TXVNB ^①	23.8 x 16.3 x 21.1	33	7/8	¾
4PXACU42BS3HAA	1.5 - 4.0	A	TXVNB ^①	23.7 x 19.8 x 21.1	38	7/8	¾
4PXABU48BS3HAA	2.0 - 4.0	A	TXVNB ^①	25.3 x 16.3 x 21.1	36	7/8	¾
4PXACU48BS3HAA	2.0 - 5.0	A	TXVNB ^①	24.9 x 19.8 x 21.1	38	7/8	¾
4PXADU48BS3HAA	2.0 - 5.0	A	TXVNB ^①	24.5 x 23.3 x 21.1	39	7/8	¾
4PXACU60BS3HAA	3.0 - 5.0	A	TXVNB ^①	29.2 x 19.8 x 21.1	44	7/8	¾
4PXADU60BS3HAA	3.0 - 5.0	A	TXVNB ^①	28.5 x 23.3 x 21.1	45	7/8	¾

① Start Kit may be required on outdoor unit.

Table COIL-2-C – 13 SEER Split System - Uncased Coil Enclosures

Model Number	Coils	Use With Furnaces Flush on Both Sides	Dimensions (in.) H x W x D	Shipping Weight (lbs.)
BAYCLE14A1422A	4PXAAU24BS	14½" Wide Furnace	22½ x 14½ x 21½	12
BAYCLE17A1722A	4PXABU24BS, 4PXABU36BS	17½" Wide Furnace	22⅝ x 17½ x 21½	14
BAYCLE21A2130A	4PXACU30BS, 4PXACU36BS, 4PXACU42BS, 4PXACU48BS	21" Wide Furnace	30 x 21 x 21½	18
BAYCLE24A2430A	4PXADU48BS, 4PXADU60BS	24½" Wide Furnace	30 x 24½ x 21½	22

Split System – Cased Heat Pump and Cooling Coils

Table COIL-3-A – All Aluminum Cased Horizontal Flat Coils R-410A Refrigerant

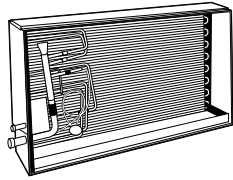

4PXF

Model Number	Cooling Capacity Range (Tons)	Coil Type	Refrigerant Control	Outlet Dim. (in.) W/H x D	Overall Dim. (in.) H x W x D	Shipping Weight (lbs.)	Line Size	
							OD Gas	OD Liq.
4PXFH001BC3HHA	1.5 - 3.0	Flat	TXVNB①	21 X 24	23.5 x 10 x 29.5	40	3/4	3/8
4PXFH004BC3HHA	2.0 - 3.5	Flat	TXVNB①	21 X 30	23.5 x 10 x 35.5	47	3/4	3/8
4PXFH007BC3HHA	3.0 - 5.0	Flat	TXVNB①	21 X 30	23.5 x 10 x 35.5	61	7/8	3/8
Variable Speed OD compatible models								
4PXFH003BZ3HHA	1.5 - 2.0	Flat	TXVNB①	21 X 30	23.5 x 10 x 35.5	47	3/4	3/8
4PXFH005BZ3HHA	2.0 - 3.5	Flat	TXVNB①	21 X 30	23.5 x 10 x 35.5	61	7/8	3/8
4PXFH009BZ3HHA	3.0 - 5.0	Flat	TXVNB①	27 X 34	29.5 X 10 X 41.5	71	7/8	3/8

① Start Kit may be required on outdoor unit.

Table COIL-3-D - Kits for 4PXC and 4TXC Coils

Horizontal Conversion Kit No.	Use with Coil Model Numbers
BAYCONV18B	4PXC**24-30
BAYCONV23B	4PXC**32-36
BAYCONV27B	4PXC**42-48
BAYCONV30B	4PXC**60
Optional Downflow Gasket Kit No.	Use with Coil Model Numbers
BAYGSKT001A0	4TXC, 4PXC

Table COIL-2-E - Air Conditioning and Heat Pump Systems

ADJUSTABLE R410A TXV KIT	4PXC-U & 4PXA:	4PXC-D	4TXC:
4AYTXVH4A1830A	24	24-30	A002
4AYTXVH4A3042A	30-42	36-42	A032, B003-C005
4AYTXVH4A4860A	48-60	48-60	B006-D010

These R-410A adjustable TXV kits are intended for use with 4TXC, 4PXC, and 4PXA coil families. In addition, these adjustable TXV kits may also be used to lower the superheat on 4TXC, 4PXC, and 4PXA coils to improve the latent capacity in high humidity environments.

Table COIL-2-F - R-22 TXV Conversion TXV Kits for 4PXC, 4PXA, 4TXC and 4PXF Coils

R-22 TXV Kit	Use with Coil Model Numbers		
2AYTXVH3H1836A	4PX**24-36	4TXC*002-005	4PXFH001, 003, 005
2AYTXVH3H4248A	4PX**42-48	4TXC*006-008	4PXFH004
2AYTXVH3H6060A	4PX**60	4TXC*009-010	4PXFH007, 009



It's Hard To Stop A Trane.®

Split System – Cased Heat Pump and Cooling Coils

Coils

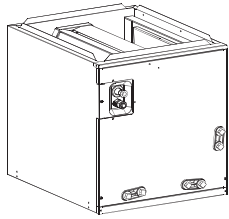

4MXC

Table COIL-4-A – Aluminum Single Stage Cased Coil (Upflow/Downflow/Horizontal) R-410A Refrigerant

Model Number	Cooling Capacity Range (Tons)	Coil Type	Refrigerant Control	Outlet Dim. (in.) W/H x D	OverallDim. (in.) H x W x D	Shipping Weight (lbs.)	Line Size OD Gas	Line Size OD Liq.
4MXCA003AC6HCA	1.5 - 3.0	A	FCCV ^①	13 x 19	20 x 14.5 x 21	51	3/4	3/8
4MXCB004AC6HCA	1.5 - 3.0	A	FCCV ^①	16 x 19	20 x 17.5 x 21	55	3/4	3/8
4MXCC005AC6HCA	2.5 - 3.0	A	FCCV ^①	19 1/2 x 19	20 x 21 x 21	59	3/4	3/8
4MXCB006AC6HCA	3.0 - 4.0	A	FCCV ^①	16 x 19	26 x 17.5 x 21	66	7/8	3/8
4MXCC007AC6HCA	3.0 - 4.0	A	FCCV ^①	19 1/2 x 19	26 x 21 x 21	70	7/8	3/8
4MXCD008AC6HCA	3.5 - 4.0	A	FCCV ^①	23 x 19	26 x 24.5 x 21	74	7/8	3/8
4MXCC009AC6HCA	3.5 - 5.0	A	FCCV ^①	19 1/2 x 19	30 x 21 x 21	91	7/8	3/8
4MXCD010AC6HCA	3.5 - 5.0	A	FCCV ^①	23 x 19	30 x 24.5 x 21	95	7/8	3/8
4MXCB016AC6HCA ^②	3.0 - 4.0	A	FCCV ^①	16 x 19	30 x 17.5 x 21	82	7/8	3/8
4MXCC017AC6HCA ^②	3.0 - 4.0	A	FCCV ^①	19 1/2 x 19	30 x 21 x 21	88	7/8	3/8
4MXCD018AC6HCA ^②	3.5 - 4.0	A	FCCV ^①	23 x 19	30 x 24.5 x 21	92	7/8	3/8

① All coils shipped with a Fixed Metering Device (Flow Control Check Valve - FCCV). Some rated combinations require a TXV kit, ordered separately. See the coil Installer's Guide for Orifice and TXV matches.

② Enhanced models for use in heating.

Table COIL-4-B – Aluminum Single Stage Cased Coil (Upflow/Downflow/Horizontal) R-410A Refrigerant

Model Number	Cooling Capacity Range (Tons)	Coil Type	Refrigerant Control	Outlet Dim. (in.) W/H x D	OverallDim. (in.) H x W x D	Shipping Weight (lbs.)	Line Size OD Gas	Line Size OD Liq.
4MXCA003AC6HCB	1.5 - 3.0	A	FCCV ^②	13 x 19	20 x 14.5 x 21	51	3/4	3/8
4MXCB004AC6HCB	1.5 - 3.0	A	FCCV ^②	16 x 19	20 x 17.5 x 21	55	3/4	3/8
4MXCC005AC6HCB	2.5 - 3.0	A	FCCV ^②	19 1/2 x 19	20 x 21 x 21	59	3/4	3/8
4MXCB006AC6HCB	3.0 - 4.0	A	FCCV ^②	16 x 19	26 x 17.5 x 21	66	7/8	3/8
4MXCC007AC6HCB	3.0 - 4.0	A	FCCV ^②	19 1/2 x 19	26 x 21 x 21	70	7/8	3/8
4MXCD008AC6HCB	3.5 - 4.0	A	FCCV ^②	23 x 19	26 x 24.5 x 21	74	7/8	3/8
4MXCC009AC6HCB	3.5 - 5.0	A	FCCV ^②	19 1/2 x 19	30 x 21 x 21	91	7/8	3/8
4MXCD010AC6HCB	3.5 - 5.0	A	FCCV ^②	23 x 19	30 x 24.5 x 21	95	7/8	3/8
4MXCB016AC6HCB ^①	3.0 - 4.0	A	FCCV ^②	16 x 19	30 x 17.5 x 21	82	7/8	3/8
4MXCC017AC6HCB ^①	3.0 - 4.0	A	FCCV ^②	19 1/2 x 19	30 x 21 x 21	88	7/8	3/8
4MXCD018AC6HCB ^①	3.5 - 4.0	A	FCCV ^②	23 x 19	30 x 24.5 x 21	92	7/8	3/8

① Enhanced models for use in heating.

② All coils shipped with a Fixed Metering Device (Flow Control Check Valve - FCCV). Some rated combinations require a TXV kit, ordered separately. See the coil Installer's Guide for Orifice and TXV matches.

Unpainted cabinet model ending in "B" to launch in Q2 2022



It's Hard To Stop A Trane.®

Split System – Cased Heat Pump and Cooling Coils

Coils

Table COIL-5-A – Refrigerant TXV Kits for 4MXC Coils

Tons	R-410A TXV Kit (If required)	R-22 TXV Kit (If required)
1.5 - 3.0	4AYTXVH3G2436A	2AYTXVH2G2436A
3.5 - 4.0	4AYTXVH3G4248B	2AYTXVH3G4248B
5	4AYTXVH3G6000B	2AYTXVH3G6000B

Note: Additional R-22 Kit combinations can be found in the Accessories section.

Table COIL-5-B – Orifice kit table for 4MXC coils

Outdoor Unit Capacity (Tons)	Orifice Size (R410A)	Orifice Kit	Orifice Size (R22)	Orifice Kit
1.5	0.052	MAYORIACHP0052B	0.052	MAYORIACHP0052B
2	0.058	MAYORIACHP0058B	0.058	MAYORIACHP0058B
2.5*	0.063 / 0.065	MAYORIACHP0063B / 065A	0.065	MAYORIACHP0065A
3	0.070	MAYORIACHP0070B	0.072	MAYORIACHP0072B
3.5	0.075	MAYORIACHP0075B	0.078	MAYORIACHP0078B
4	0.083	MAYORIACHP0083B	0.088	MAYORIACHP0088B
5	0.090	MAYORIACHP0090B	0.096	MAYORIACHP0096B

Note: Orifice size needed for system combination may not be pre-installed. See Table 1 in coil Installation Manual for pre-installed size.

* Necessary Orifice sizes varies for this tonnage. See Table 3 in coil Installation Manual.

Split System – Cased Heat Pump and Cooling Coils

Table COIL-5-C – Features

	4TXC	4PXC-U	4PXC-D	4AXA	4PXA	4PXF	4MXC
• All aluminum coil	✓	✓	✓	✓	✓	✓ ^④	✓
• Enhanced Fin Surface.....	✓	✓	✓	✓	✓	–	–
• 100% foil lined insulation.....	✓	✓	✓	–	–	✓	✓
• Internally checked non-bleed thermal expansion valve with mechanical fitting on both sides (heat pump operation).....	✓	✓	✓	✓	–	✓	–
• Factory installed fixed orifice. Additional orifices supplied.	–	–	–	–	–	–	✓
• Optional accessory TXV Kit with mechanical fittings available for higher performance ratings ^③	–	–	–	–	–	–	✓
• Easy case attachment to furnace.....	✓	✓	✓	–	–	–	✓
• Upflow application	✓	✓	–	✓	–	–	✓
• Downflow application	✓	✓	✓	✓	–	–	✓
• Horizontal Right application.....	✓	kit	kit	–	–	✓	✓
• Horizontal Left application	✓	kit	–	–	–	✓	✓
• Double sloped non-corrosive drain pan - UL rated 400°F. Compatible with oil furnaces.....	✓	✓	✓	–	–	–	–
• Single sloped non-corrosive drain pan.....	–	–	–	✓	–	✓	✓
• Compatible with variable speed and 2 speed outdoor models.....	✓	✓	✓	✓	–	②	–
• Split inner and outer doors for easy coil inspection and cleaning	✓	✓	✓	–	–	–	–
• Painted galvanized steel cabinet	✓	✓	✓	–	–	–	A*
• Unpainted galvanized steel cabinet.....	–	–	–	–	–	✓	B*
• 10-year limited warranty on coil, & all other functional parts, with registration ^⑤	✓	✓	✓	✓	✓	✓	✓

① Start kit may be required on outdoor unit.

② See Tables COIL-3-A and COIL-3-B for specific models that are compatible with variable speed outdoor products.

③ Reference AHRI ratings to find correct TXV kit or reference Product Data for additional information.

④ 4PXF coils with a "B" as the 9th digit will be all-aluminum design. Those with an "A" in the 9th digit still have copper tubes.

⑤ Registered Limited Warranty terms are available when you register within 60 days of installation. You can register online at Trane.com or by phone at 855-260-2975, otherwise Trane's Base Limited Warranty terms will apply. Base Limited Warranty information on specific products can be found on ComfortSite.com.

* 4MXC coils with a "B" as the 14th digit will have an unpainted galvanized steel cabinet. Those with an "A" in the 14th digit will have a painted galvanized steel cabinet.

S9V2-VS – Two Stage ECM Variable Speed

Table FUR-1-A – S9V2-VS Variable Speed, 2 Stage, Direct/Non-Direct Vent, Upflow/Horizontal Left/Horizontal Right Condensing Gas Furnace with Variable Speed Draft Inducer (120/1/60)③

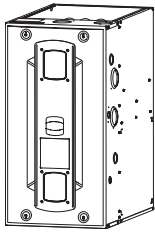

**S9V2-VS
Direct Vent
Upflow**

Unit Model Number	Airflow In Tons	Output (Btuh)		ICS① AFUE	Flue Size (in)	Ignition Device	Uncrated Dimensions (in.) H x W x D	Shipping Weight (lbs.)	Max Fuse*	Filter Sizes**
		Stage 2	Stage 1							
S9V2B040U3VSAD	3	39,141	25,639	97.0②	2, 3, 4	④	34 x 17 ¹ / ₂ x 28 ³ / ₄	122	15	16 x 25 x 1
S9V2B060U3VSAD	3	57,838	38,271	97.0②	2, 3, 4	④	34 x 17 ¹ / ₂ x 28 ³ / ₄	127	15	16 x 25 x 1
S9V2B080U4VSAD	4	78,400	50,960	97.0②	2, 3, 4	④	34 x 17 ¹ / ₂ x 28 ³ / ₄	135	15	16 x 25 x 1
S9V2C100U4VSAD	4	96,362	64,036	97.0②	2, 3, 4	④	34 x 21 x 28 ³ / ₄	154	15	20 x 25 x 1
S9V2D120U5VSAD	5	113,145	76,668	97.0②	3, 4	④	34 x 24 ¹ / ₂ x 28 ³ / ₄	167	15	24 x 25 x 1

Table FUR-1-B – S9V2-VS Variable Speed, 2 Stage, Direct/Non-Direct Vent, Downflow Condensing Gas Furnace with Variable Speed Draft Inducer (120/1/60)③

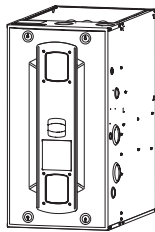

**S9V2-VS
Direct Vent
Downflow**

Unit Model Number	Airflow In Tons	Output (Btuh)		ICS① AFUE	Flue Size (in)	Ignition Device	Uncrated Dimensions (in.) H x W x D	Shipping Weight (lbs.)	Max Fuse*	Filter Sizes**
		Stage 2	Stage 1							
S9V2B080D4VSAD	4	78,400	50,960	97.0②	2, 3, 4	④	34 x 17 ¹ / ₂ x 28 ³ / ₄	135	15	(2)14 x 20 x 1
S9V2C100D4VSAD	4	95,833	63,950	97.0②	2, 3, 4	④	34 x 21 x 28 ³ / ₄	154	15	(2)16 x 20 x 1

Note: Variable speed furnaces should not be twinned and are not approved for twinning applications.

① Isolated Combustion System. AFUE may vary based on poise.

② Energy Star®.

③ Direct drive variable speed motor is an ECM constant airflow blower motor.

④ Silicon Nitride Igniter.

* Information subject to change. Please confirm with current Product Data/Service Facts for current factory production.

** Filters are not shipped with furnace. For Upflow furnaces, the size is for a bottom return filter.

S9V2 – Two Stage ECM Variable Speed

Table FUR-1-C – S9V2 Variable Speed, 2 Stage, Direct/Non-Direct Vent, Upflow/Horizontal Left/Horizontal Right Condensing Gas Furnace (120/1/60)③

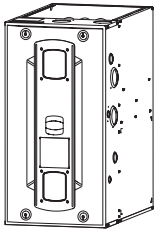

**S9V2
Direct Vent
Upflow**

Unit Model Number	Airflow In Tons	Output (Btuh)		ICS① AFUE	Flue Size (in)	Ignition Device	Uncrated Dimensions (in.) H x W x D	Shipping Weight (lbs.)	Max Fuse*	Filter Sizes**
		Stage 2	Stage 1							
S9V2B040U3PSBD	3	38,800	25,220	96.0②	2, 3, 4	④	34 x 17 ¹ / ₂ x 28 ³ / ₄	122	15	16 x 25 x 1
S9V2B060U4PSBD	4	58,200	37,830	96.0②	2, 3, 4	④	34 x 17 ¹ / ₂ x 28 ³ / ₄	130	15	16 x 25 x 1
S9V2B080U4PSBD	4	77,600	50,440	96.0②	2, 3, 4	④	34 x 17 ¹ / ₂ x 28 ³ / ₄	135	15	16 x 25 x 1
S9V2C080U5PSBD	5	77,600	50,440	96.0②	2, 3, 4	④	34 x 21 x 28 ³ / ₄	149	15	20 x 25 x 1
S9V2C100U5PSBD	5	97,000	63,050	96.0②	2, 3, 4	④	34 x 21 x 28 ³ / ₄	155	15	20 x 25 x 1
S9V2D120U5PSBD	5	116,400	75,660	96.0②	3, 4	④	34 x 24 ¹ / ₂ x 28 ³ / ₄	167	15	24 x 25 x 1

Table FUR-1-D – S9V2 Variable Speed, 2 Stage, Direct/Non-Direct Vent, Downflow Condensing Gas Furnace (120/1/60)③

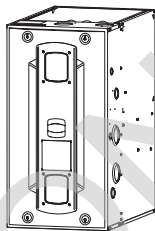

**S9V2
Direct Vent
Downflow**

Unit Model Number	Airflow In Tons	Output (Btuh)		ICS① AFUE	Flue Size (in)	Ignition Device	Uncrated Dimensions (in.) H x W x D	Shipping Weight (lbs.)	Max Fuse*	Filter Sizes**
		Stage 2	Stage 1							
S9V2B040D3PSBD	3	38,800	25,220	96.0②	2, 3, 4	④	34 x 17 ¹ / ₂ x 28 ³ / ₄	122	15	(2)14 x 20 x 1
S9V2B060D3PSBD	3	58,200	37,830	96.0②	2, 3, 4	④	34 x 17 ¹ / ₂ x 28 ³ / ₄	127	15	(2)14 x 20 x 1
S9V2B080D4PSBD	4	77,600	50,440	96.0②	2, 3, 4	④	34 x 17 ¹ / ₂ x 28 ³ / ₄	135	15	(2)14 x 20 x 1
S9V2C100D5PSBD	5	97,000	63,050	96.0②	2, 3, 4	④	34 x 21 x 28 ³ / ₄	155	15	(2)16 x 20 x 1
S9V2D120D5PSBD	5	116,400	75,660	96.0②	3, 4	④	34 x 24 ¹ / ₂ x 28 ³ / ₄	167	15	(2)16 x 20 x 1

Note: Variable speed furnaces should not be twinned and are not approved for twinning applications.

① Isolated Combustion System. AFUE may vary based on poise.

② Energy Star®.

③ Direct drive variable speed motor is an ECM constant airflow blower motor.

④ Silicon Nitride Igniter.

* Information subject to change. Please confirm with current Product Data/Service Facts for current factory production.

** Filters are not shipped with furnace. For Upflow furnaces, the size is for a bottom return filter.

S9X2 – Two Stage High Efficiency ECM

Table FUR-2-A – S9X2 High Efficiency 9 Speed ECM Motor, 2 Stage, Direct/Non-Direct Vent, Upflow/Horizontal Left/Horizontal Right Condensing Gas Furnace (120/1/60)Ⓢ

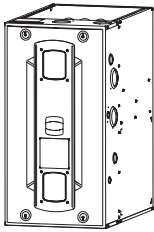

**S9X2
Direct Vent
Upflow**

Unit Model Number	Airflow In Tons	Output (Btuh)		ICS ^① AFUE	Flue Size (in)	Ignition Device	Uncrated Dimensions (in.) H x W x D	Shipping Weight (lbs.)	Max Fuse*	Filter Sizes**
		Stage 2	Stage 1							
S9X2B040U3PSBA	3	38,800	25,220	96.0 ^②	2, 3, 4	④	34 x 17 ¹ / ₂ x 28 ³ / ₄	122	15	16 x 25 x 1
S9X2B060U4PSBA	4	58,200	37,830	96.0 ^②	2, 3, 4	④	34 x 17 ¹ / ₂ x 28 ³ / ₄	130	15	16 x 25 x 1
S9X2B080U4PSBA	4	77,600	50,440	96.0 ^②	2, 3, 4	④	34 x 17 ¹ / ₂ x 28 ³ / ₄	135	15	16 x 25 x 1
S9X2C080U5PSBA	5	77,600	50,440	95.0 ^②	2, 3, 4	④	34 x 21 x 28 ³ / ₄	149	15	20 x 25 x 1
S9X2C100U5PSBA	5	97,000	63,050	96.0 ^②	2, 3, 4	④	34 x 21 x 28 ³ / ₄	155	15	20 x 25 x 1
S9X2D120U5PSBA	5	116,400	75,660	96.0 ^②	3, 4	④	34 x 24 ¹ / ₂ x 28 ³ / ₄	167	15	24 x 25 x 1

Table FUR-2-B – S9X2 High Efficiency 9 Speed ECM Motor, 2 Stage, Direct/Non-Direct Vent, Downflow Condensing Gas Furnace (120/1/60)Ⓢ

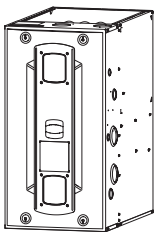

**S9X2
Direct Vent
Downflow**

Unit Model Number	Airflow In Tons	Output (Btuh)		ICS ^① AFUE	Flue Size (in)	Ignition Device	Uncrated Dimensions (in.) H x W x D	Shipping Weight (lbs.)	Max Fuse*	Filter Sizes**
		Stage 2	Stage 1							
S9X2B040D3PSBA	3	38,800	25,220	96.0 ^②	2, 3, 4	④	34 x 17 ¹ / ₂ x 28 ³ / ₄	122	15	(2)14 x 20 x 1
S9X2B060D3PSBA	3	58,200	37,830	95.0 ^②	2, 3, 4	④	34 x 17 ¹ / ₂ x 28 ³ / ₄	127	15	(2)14 x 20 x 1
S9X2B080D4PSBA	4	77,600	50,440	96.0 ^②	2, 3, 4	④	34 x 17 ¹ / ₂ x 28 ³ / ₄	135	15	(2)14 x 20 x 1
S9X2C100D5PSBA	5	97,000	63,050	95.0 ^②	2, 3, 4	④	34 x 21 x 28 ³ / ₄	155	15	(2)16 x 20 x 1
S9X2D120D5PSBA	5	116,400	75,660	96.0 ^②	3, 4	④	34 x 24 ¹ / ₂ x 28 ³ / ₄	167	15	(2)16 x 20 x 1

① Isolated Combustion System. AFUE may vary based on poise.

② Energy Star®.

③ Direct drive 9 speed motor is a high efficiency constant torque ECM blower motor.

④ Silicon Nitride Igniter.

* Information subject to change. Please confirm with current Product Data/Service Facts for current factory production.

** Filters are not shipped with furnace. For Upflow furnaces, the size is for a bottom return filter.

Table FUR-2-C – High Altitude Pressure Switch S9V2-VS 90% Furnaces

Model Number	Description	Used With	Shipping Weight
BAYHALT250	2 Switches	S9V2B040U3VSA	2
BAYHALT251	2 Switches	S9V2B060U3VSA	2
BAYHALT252	2 Switches	S9V2B080U4VSA, S9V2B080D4VSA, S9V2C100D4VSA	2
BAYHALT253	2 Switches	S9V2C100U4VSA	2
BAYHALT254	2 Switches	S9V2D120U5VSA	2

Convertible Gas Furnaces

Table FUR-3-A – Features

	S9V2-VS Variable Speed	S9V2 Variable Speed	S9X2 Multi-Speed
• Direct drive, variable speed ECM blower motor - Constant airflow ECM (electronically commutated motor).....	✓	✓	—
• Direct drive, multi speed ECM blower motor - Constant torque ECM (electronically commutated motor)	—	—	✓
• Variable speed draft inducer motor.....	✓	✓	✓
• Comfort-R™ enhanced mode (cooling)	✓	✓	—
• Standard 34" height.....	✓	✓	✓
• 3 Way poise Upflow furnace model (Upflow, Horizontal Left, Horizontal Right).....	✓	✓	✓
• Dedicated Downflow furnace model.....	✓	✓	✓
• Front service access with easily accessible burners, sensors, orifices, switches, and other components	✓	✓	✓
• Cabinet has no knockouts - Rubber and plastic plugs come installed from factory	✓	✓	✓
• Gas can enter either side of cabinet.....	✓	✓	✓
• Condensate can exit either side of cabinet in Upflow orientation.....	✓	✓	✓
• Multiple venting options - Every model, every size will offer two venting options.....	✓	✓	✓
• Integrated Furnace Control board with digital configuration, status, and fault codes	✓	✓	✓
• Alpha-numeric diagnostic codes	✓	✓	✓
• Dry contact Humidifier/EAC hook-up capability.....	✓	✓	✓
• Adjustable blower off delay for heating and cooling.....	✓	✓	✓
• Last six fault codes are stored (even with power loss).....	✓	✓	✓
• Stainless steel primary and secondary heat exchanger tubes	✓	✓	✓
• Longer IFC wire harnesses allow door to be removed without disconnecting the harness.....	✓	✓	✓
• Alternate bottom/left/right return air (upflow models only).....	✓	✓	✓
• Bottom panel.....	✓	✓	✓
• Dual PVC pipe venting (1 or 2 pipe option).....	✓	✓	✓
• Two stage combination gas valve and regulator	✓	✓	✓
• Gasketed inner and outer door.....	✓	✓	✓
• Heavy gauge reinforced wrap-around steel cabinet	✓	✓	✓
• Insulated blower compartment	✓	✓	✓
• Left/right condensate drain capability in vertical application	✓	✓	✓
• Service diagnostics with faults reported on IFC board	✓	✓	✓
• Manual reset flame roll out switches.....	✓	✓	✓
• Mobile home approved with mobile home kit.....	✓	✓	✓
• Multi-port in shot burners	✓	✓	✓
• Service diagnostic capabilities	✓	✓	✓
• Vortica™ II blower housing	✓	✓	✓
• Slide out blower assembly on full-length rails.....	✓	✓	✓
• Side return duct starter tabs (upflow models only).....	✓	✓	✓
• Silicon Nitride 120V hot surface igniter	✓	✓	✓
• Multiple heating blower speeds.....	✓	✓	✓
• Meets requirements for 1% or less air leakage.....	✓	✓	✓
• Limited lifetime heat exchanger warranty & 10-year on all other functional parts with registration (Residential Use)	✓	✓	✓
• Optional extended warranties available	✓	✓	✓

Note: Variable speed furnaces should not be twinned and are not approved for twinning applications.

* Registered Limited Warranty terms are available when you register within 60 days of installation. You can register online at Trane.com or by phone at 855-260-2975, otherwise Trane's Base Limited Warranty terms will apply. Base Limited Warranty information on specific products can be found on ComfortSite.com.

Table FUR-3-B – Optional Accessories

Model Number	Description	Shipping Weight	S9V2-VS Variable Speed	S9V2 Variable Speed	S9X2 Multi-Speed
AYLPSS400C	LP Kit with Stainless Steel Burners.....	3.....	✓	✓	✓
BAYHANG	Horizontal hanging kit.....	2.....	✓	✓	✓
BAYVENT200B.....	Sidewall vent Termination Kit fo Direct vent furnaces	2.....	✓	✓	✓
BAYVENTCN200B	Sidewall vent Termination Kit fo Direct vent furnaces for Canadian applications ..	2.....	✓	✓	✓
BAYAIR30AVENTA	Concentric vent kit for 2, 2½ and 3" vent system.....	11.....	✓	✓	✓
BAYAIR30CNVENT	Concentric vent kit for 2, 2½ and 3" vent system for Canadian applications.....	11.....	✓	✓	✓
BAYREDUCE	Reducer Coupling for Canadian applications (CPVC)	1.....	✓	✓	✓
BAYLIFTB.....	Dual return kit. B size extension.....	8.....	✓	✓	✓
BAYLIFTC	Dual return kit. C size extension.....	9.....	✓	✓	✓
BAYLIFTD	Dual return kit. D size extension.....	9.....	✓	✓	✓
BAYMFGH200B	Manufactured/mobile home kit	1.....	✓	✓	✓
BAYCNDTRAP2A.....	In-line condensate collector for 2" PVC pipe	1.....	✓	✓	✓
BAYCNDTRAP3A.....	In-line condensate collector for 3" PVC pipe	1.....	✓	✓	✓
BAYBASE205.....	Downflow subbase	8.....	✓	✓	✓
BAYFLTR206.....	Filter Access Door Kit (Downflow only)	2.....	✓	✓	✓
MAYBFERCOLKITA ①.....	Heat Shield, B size cabinet.....	3.....	✓	✓	✓
MAYCFERCOLKITA ①.....	Heat Shield, C size cabinet.....	3.....	✓	✓	✓
MAYDFERCOLKITA ①.....	Heat Shield, D size cabinet.....	3.....	✓	✓	✓
BAYSF1165.....	16x20 1" side return filter rack	✓	✓	✓
BAYSF1255.....	16x25 1" side return filter rack (bottom return for 17.5" cabinets).....	✓	✓	✓
BAYBURNERSS.....	Stainless steel natural gas burner kit.....	✓	✓	✓

① Required on furnaces manufactured on or after 7/3/19 (with date code 19273 or after) when installed with a 4MXC or 4GXC coils in upflow or horizontal position. Not required in Downflow orientation.

S9X1 – Single Stage High Efficiency ECM

Table FUR-4-A – S9X1 High Efficiency 9 Speed ECM Motor, 1 Stage, Direct/Non-Direct Vent, Upflow/Horizontal Left/Horizontal Right Condensing Gas Furnace (120/1/60)Ⓢ

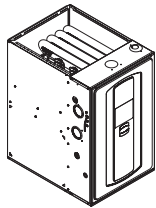

**S9X1
Direct Vent
Upflow**

Unit Model Number	Airflow In Tons	Nominal Output (Btuh)	ICSⓈ AFUE	Flue Size (in)	Ignition Device	Uncrated Dimensions (in.) H x W x D	Shipping Weight (lbs.)	Max Fuse*	Filter Sizes**
S9X1B040U3PSBA	3	39,000	96.0Ⓢ	2, 3, 4	Ⓢ	34 x 17 ¹ / ₂ x 28 ³ / ₄	122	15	16 x 25 x 1
S9X1B060U4PSBA	4	58,300	96.0Ⓢ	2, 3, 4	Ⓢ	34 x 17 ¹ / ₂ x 28 ³ / ₄	130	15	16 x 25 x 1
S9X1B080U4PSBA	4	77,200	96.0Ⓢ	2, 3, 4	Ⓢ	34 x 17 ¹ / ₂ x 28 ³ / ₄	135	15	16 x 25 x 1
S9X1C080U5PSBA	5	77,800	96.0Ⓢ	2, 3, 4	Ⓢ	34 x 21 x 28 ³ / ₄	149	15	20 x 25 x 1
S9X1C100U5PSBA	5	97,400	95.0Ⓢ	2, 3, 4	Ⓢ	34 x 21 x 28 ³ / ₄	155	15	20 x 25 x 1
S9X1D120U5PSBA	5	113,400	95.0Ⓢ	3, 4	Ⓢ	34 x 24 ¹ / ₂ x 28 ³ / ₄	167	15	24 x 25 x 1

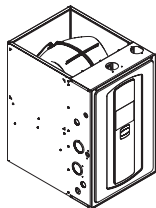

**S9X1
Direct Vent
Downflow**

Table FUR-4-B – S9X1 High Efficiency 9 Speed ECM Motor, 1 Stage, Direct/Non-Direct Vent, Downflow Condensing Gas Furnace (120/1/60)Ⓢ

Unit Model Number	Airflow In Tons	Nominal Output (Btuh)	ICSⓈ AFUE	Flue Size (in)	Ignition Device	Uncrated Dimensions (in.) H x W x D	Shipping Weight (lbs.)	Max Fuse*	Filter Sizes**
S9X1B040D3PSBA	3	38,900	96.0Ⓢ	2, 3, 4	Ⓢ	34 x 17 ¹ / ₂ x 28 ³ / ₄	122	15	(2)14 x 20 x 1
S9X1B060D3PSBA	3	57,600	96.0Ⓢ	2, 3, 4	Ⓢ	34 x 17 ¹ / ₂ x 28 ³ / ₄	127	15	(2)14 x 20 x 1
S9X1B080D4PSBA	4	76,900	95.0Ⓢ	2, 3, 4	Ⓢ	34 x 17 ¹ / ₂ x 28 ³ / ₄	135	15	(2)14 x 20 x 1
S9X1C100D5PSBA	5	96,800	96.0Ⓢ	2, 3, 4	Ⓢ	34 x 21 x 28 ³ / ₄	155	15	(2)16 x 20 x 1
S9X1D120D5PSBA	5	115,500	95.0Ⓢ	3, 4	Ⓢ	34 x 24 ¹ / ₂ x 28 ³ / ₄	167	15	(2)16 x 20 x 1

Ⓢ Isolated Combustion System. AFUE may vary based on poise.

Ⓢ Energy Star®.

Ⓢ Direct drive 9 speed motor is a high efficiency constant torque ECM blower motor.

Ⓢ Silicon Nitride Igniter.

* Information subject to change. Please confirm with current Product Data/Service Facts for current factory production.

** Filters are not shipped with furnace. For Upflow furnaces, the size is for a bottom return filter.

S9B1 – Single Stage High Efficiency ECM

Table FUR-4-C – S9B1 High Efficiency 9 Speed ECM Motor, 1 Stage, Direct/Non-Direct Vent, Upflow/Horizontal Left/Horizontal Right Condensing Gas Furnace (120/1/60)Ⓢ

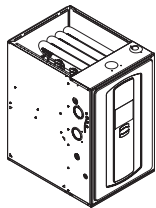

**S9B1
Direct Vent
Upflow**

Unit Model Number	Airflow In Tons	Nominal Output (Btuh)	ICSⓈ AFUE	Flue Size (in)	Ignition Device	Uncrated Dimensions (in.) H x W x D	Shipping Weight (lbs.)	Max Fuse*	Filter Sizes**
S9B1B040U3PSAA	3	39,000	92.1Ⓢ	2, 3, 4	Ⓢ	34 x 17 ¹ / ₂ x 28 ³ / ₄	122	15	16 x 25 x 1
S9B1B060U4PSAA	4	58,300	92.1Ⓢ	2, 3, 4	Ⓢ	34 x 17 ¹ / ₂ x 28 ³ / ₄	130	15	16 x 25 x 1
S9B1B080U4PSAA	4	77,200	92.1Ⓢ	2, 3, 4	Ⓢ	34 x 17 ¹ / ₂ x 28 ³ / ₄	135	15	16 x 25 x 1
S9B1C080U5PSAA	5	77,800	92.1Ⓢ	2, 3, 4	Ⓢ	34 x 21 x 28 ³ / ₄	149	15	20 x 25 x 1
S9B1C100U5PSAA	5	97,400	92.1Ⓢ	2, 3, 4	Ⓢ	34 x 21 x 28 ³ / ₄	155	15	20 x 25 x 1
S9B1D120U5PSAA	5	113,400	92.1Ⓢ	3, 4	Ⓢ	34 x 24 ¹ / ₂ x 28 ³ / ₄	167	15	24 x 25 x 1

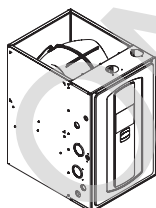

**S9B1
Direct Vent
Downflow**

Table FUR-4-D – S9B1 High Efficiency 9 Speed ECM Motor, 1 Stage, Direct/Non-Direct Vent, Downflow Condensing Gas Furnace (120/1/60)Ⓢ

Unit Model Number	Airflow In Tons	Nominal Output (Btuh)	ICSⓈ AFUE	Flue Size (in)	Ignition Device	Uncrated Dimensions (in.) H x W x D	Shipping Weight (lbs.)	Max Fuse*	Filter Sizes**
S9B1B040D3PSAA	3	38,900	92.1Ⓢ	2, 3, 4	Ⓢ	34 x 17 ¹ / ₂ x 28 ³ / ₄	122	15	(2)14 x 20 x 1
S9B1B060D3PSAA	3	57,600	92.1Ⓢ	2, 3, 4	Ⓢ	34 x 17 ¹ / ₂ x 28 ³ / ₄	127	15	(2)14 x 20 x 1
S9B1B080D4PSAA	4	76,900	92.1Ⓢ	2, 3, 4	Ⓢ	34 x 17 ¹ / ₂ x 28 ³ / ₄	135	15	(2)14 x 20 x 1
S9B1C100D5PSAA	5	96,800	92.1Ⓢ	2, 3, 4	Ⓢ	34 x 21 x 28 ³ / ₄	155	15	(2)16 x 20 x 1
S9B1D120D5PSAA	5	115,500	92.1Ⓢ	3, 4	Ⓢ	34 x 24 ¹ / ₂ x 28 ³ / ₄	167	15	(2)16 x 20 x 1

Ⓢ Isolated Combustion System. AFUE may vary based on poise.

Ⓢ Energy Star® - U.S. South

Ⓢ Direct drive 9 speed motor is a high efficiency constant torque ECM blower motor.

Ⓢ Silicon Nitride Igniter.

* Information subject to change. Please confirm with current Product Data/Service Facts for current factory production.

** Filters are not shipped with furnace. For Upflow furnaces, the size is for a bottom return filter.



It's Hard To Stop A Trane.®

Convertible Gas Furnaces

Table FUR-5-A – Features

	S9X1 Multi-Speed	S9B1 Multi-Speed
• Dry contact Humidifier/EAC hook-up capability.....	✓	—
• Insulated blower compartment.....	✓	—
• Meets requirements for 1% or less air leakage ①.....	✓	—
• Standard 34" height.....	✓	—
• 3 Way poise Upflow furnace model (Upflow, Horizontal Left, Horizontal Right).....	✓	✓
• Dedicated Downflow furnace model.....	✓	✓
• Front service access with easily accessible burners, sensors, orifices, switches, and other components.....	✓	✓
• Cabinet has no knockouts - Rubber and plastic plugs come installed from factory.....	✓	✓
• Gas can enter either side of cabinet.....	✓	✓
• Condensate can exit either side of cabinet in Upflow orientation.....	✓	✓
• Multiple venting options - Every model, every size will offer two venting options.....	✓	✓
• Integrated Furnace Control board with digital configuration, status, and fault codes.....	✓	✓
• Alpha-numeric diagnostic codes.....	✓	✓
• Adjustable blower off delay for heating and cooling.....	✓	✓
• Last six fault codes are stored (even with power loss).....	✓	✓
• Stainless steel primary and secondary heat exchanger tubes.....	✓	✓
• Longer IFC wire harnesses allow door to be removed without disconnecting the harness.....	✓	✓
• Alternate bottom/left/right return air (upflow models only).....	✓	✓
• Bottom panel.....	✓	✓
• Direct drive, 9 speed ECM blower motor - Constant torque ECM (electronically commutated motor).....	✓	✓
• Dual PVC pipe venting (1 or 2 pipe option).....	✓	✓
• Single-stage combination gas valve and regulator.....	✓	✓
• Gasketed inner and outer door.....	✓	✓
• Heavy gauge reinforced wrap-around steel cabinet.....	✓	✓
• Left/right condensate drain capability in vertical application.....	✓	✓
• Service diagnostics with faults reported on IFC board.....	✓	✓
• Manual reset flame roll out switches.....	✓	✓
• Mobile home approved with mobile home kit.....	✓	✓
• Multi-port in shot burners.....	✓	✓
• Service diagnostic capabilities.....	✓	✓
• Vortica™ II blower housing.....	✓	✓
• Slide out blower assembly on full-length rails.....	✓	✓
• Side return duct starter tabs (upflow models only).....	✓	✓
• Silicon Nitride 120V hot surface igniter.....	✓	✓
• Multiple heating blower speeds.....	✓	✓
• Limited lifetime heat exchanger warranty & 10-year on all other functional parts with registration (Residential Use).....	✓	✓
• Optional extended warranties available.....	✓	✓

① 1.4% on S9B1 models.

* Registered Limited Warranty terms are available when you register within 60 days of installation. You can register online at Trane.com or by phone at 855-260-2975, otherwise Trane's Base Limited Warranty terms will apply. Base Limited Warranty information on specific products can be found on ComfortSite.com.

Table FUR-5-B – Optional Accessories

Model Number	Description	Shipping Weight	S9X1 - 1 Stage 1 or 2 Pipe	S9B1 - 1 Stage 1 or 2 Pipe
BAYLPSS400C.....	LP Kit with Stainless Steel Burners.....	3.....	✓	✓
BAYHANG.....	Horizontal hanging kit.....	2.....	✓	✓
BAYVENT200B.....	Sidewall vent Termination Kit fo Direct vent furnaces.....	2.....	✓	✓
BAYVENTCN200B.....	Sidewall vent Termination Kit fo Direct vent furnaces for Canadian applications.....	2.....	✓	✓
BAYAIR30AVENTA.....	Concentric vent kit for 2, 2½ and 3" vent system.....	11.....	✓	✓
BAYAIR30CNVENT.....	Concentric vent kit for 2, 2½ and 3" vent system for Canadian applications.....	11.....	✓	✓
BAYREDUCE.....	Reducer Coupling for Canadian applications (CPVC).....	1.....	✓	✓
BAYLIFTB.....	Dual return kit. B size extension.....	8.....	✓	✓
BAYLIFTC.....	Dual return kit. C size extension.....	9.....	✓	✓
BAYLIFTD.....	Dual return kit. D size extension.....	9.....	✓	✓
BAYMFGH200B.....	Manufactured/mobile home kit.....	1.....	✓	✓
BAYCNDTRAP2A.....	In-line condensate collector for 2" PVC pipe.....	1.....	✓	✓
BAYCNDTRAP3A.....	In-line condensate collector for 3" PVC pipe.....	1.....	✓	✓
BAYBASE205.....	Downflow subbase.....	8.....	✓	✓
BAYFLTR206.....	Filter Access Door Kit (Downflow only).....	2.....	✓	✓
MAYBFERCOLKITA 2.....	Heat Shield, B size cabinet.....	3.....	✓	✓
MAYCFERCOLKITA 2.....	Heat Shield, C size cabinet.....	3.....	✓	✓
MAYDFERCOLKITA 2.....	Heat Shield, D size cabinet.....	3.....	✓	✓
BAYSF1165.....	16x20 1" side return filter rack.....	✓	✓
BAYSF1255.....	16x25 1" side return filter rack (bottom return for 17.5" cabinets).....	✓	✓
BAYBURNERSS.....	Stainless steel natural gas burner kit.....	✓	✓

② Required on furnaces manufactured on or after 7/3/19 (with date code 19273 or after) when installed with a 4MXC or 4GXC coils in upflow or horizontal position. Not required in Downflow orientation.

For complete equipment / combination selections, installation instructions and warranty information, please refer to Product Data/Ratings and/or Installers Guides and Limited Warranty Handbooks.

XC95m Convertible Gas Furnaces Air Flow Directions

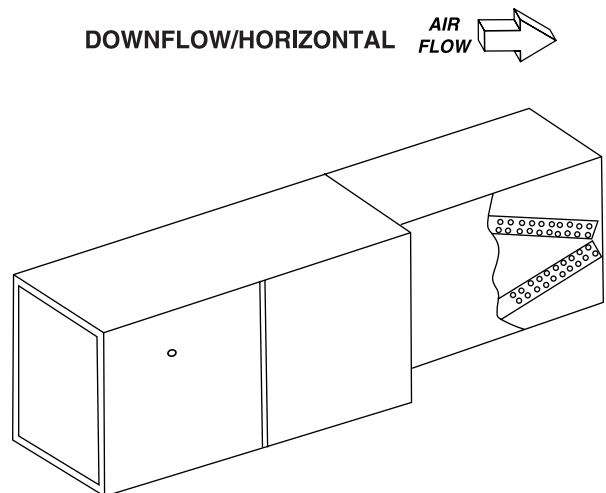
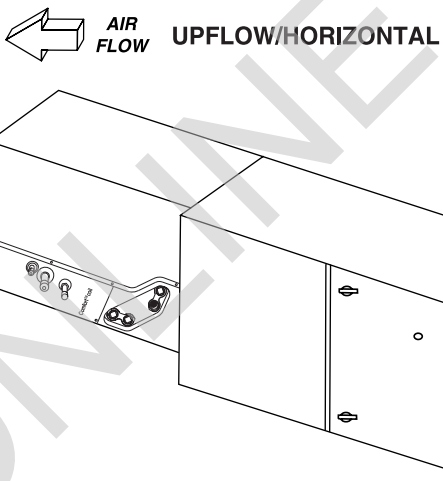
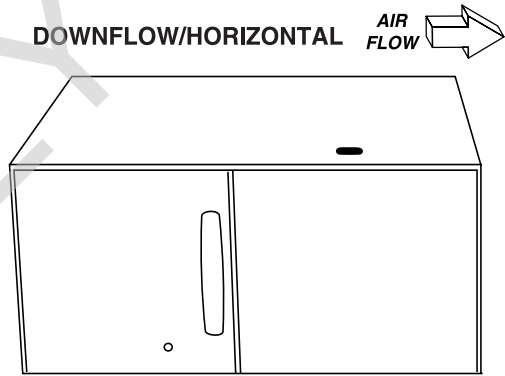
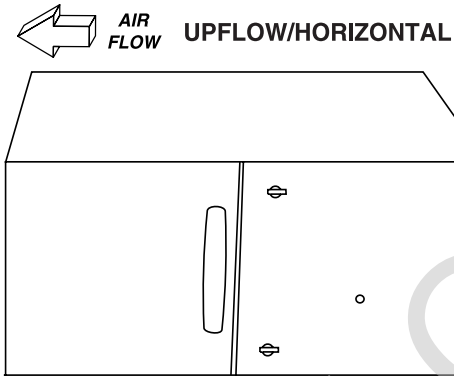
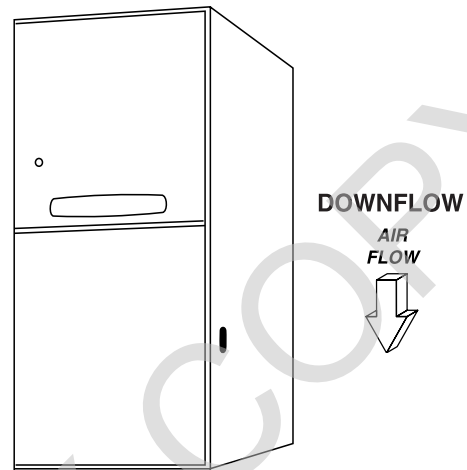
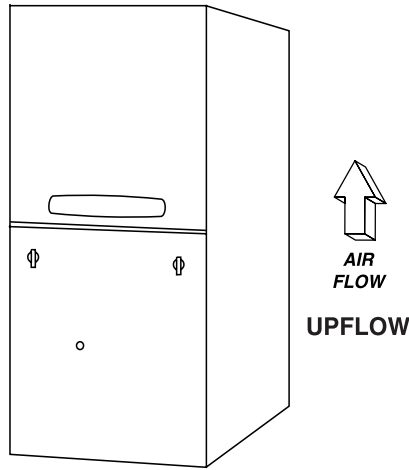

Note: The forty inch (40") height condensing downflow/horizontal and upflow/horizontal furnaces may only be rotated onto their left side. Connection brackets for coil/furnace alignment are included with the furnaces. The apex of the coil may point into or away from the airflow.



It's Hard To Stop A Trane.®

XC95m – Modulating Communicating ECM Variable Speed

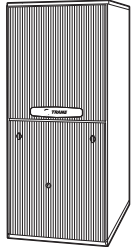

XC95m Direct/Non-Direct Vent Upflow

Table FUR-7-A – XC95m Variable Speed, Communicating, Modulating Direct/Non-Direct Vent, Upflow/Horizontal Left Condensing Gas Furnace (115/1/60)ⓈⓉⓊ

Unit Model No.	Airflow In Tons	Output (Btuh)		ICS ^① AFUE Upflow / Horiz	Flue Size (in)	Uncrated Dimensions (in.) H x W x D	Shipping Weight (lbs.)	Max Fuse*	Filter Sizes**
		High Stage 100%	Low Stage 40% ^③						
TUHMB060ACV3VB	3	57,000	23,000	97.3 ^② / 96.5 ^②	2, 2 1/2, 3	40 x 17 1/2 x 28	158	15	17 x 25 x 1
TUHMB080ACV3VB	3	76,000	31,000	97.0 ^② / 96.2 ^②	2, 2 1/2, 3	40 x 17 1/2 x 28	168	15	17 x 25 x 1
TUHMC100ACV4VB	4	95,000	39,000	96.0 ^② / 95.2 ^②	2 1/2, 3	40 x 21 x 28	197	15	20 x 25 x 1
TUHMD120ACV5VB	5	114,000	52,000	97.0 ^② / 96.2 ^②	3	40 x 24 1/2 x 28	206	15	24 x 25 x 1

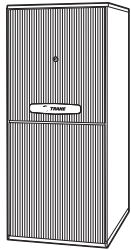

XC95m Direct/Non-Direct Vent Downflow

Table FUR-7-B – XC95m Variable Speed, Communicating Modulating Direct/Non-Direct Vent, Downflow/Horizontal Right Condensing Gas Furnace (115/1/60)ⓈⓉⓊ

Unit Model No.	Airflow In Tons	Output (Btuh)		ICS ^① AFUE	Flue Size (in)	Ignition Device	Uncrated Dimensions (in.) H x W x D	Shipping Weight (lbs.)	Max Fuse*	Filter Sizes
		High Stage 100%	Low Stage 40%							
TDHMB060BCV3VB	3	57,000	22,800	95.0 ^②	2, 2 1/2, 3	Ⓢ	40 x 17 1/2 x 28	160	15	(2)14 x 20 x 1
TDHMB080ACV3VB	3	76,000	30,400	96.0 ^②	2, 2 1/2, 3	Ⓢ	40 x 17 1/2 x 28	168	15	(2)14 x 20 x 1
TDHMC100ACV4VB	4	96,000	38,400	96.0 ^②	2 1/2, 3	Ⓢ	40 x 21 x 28	185	15	(2)16 x 20 x 1
TDHMD120BCV5VB	5	114,000	51,300	95.0 ^②	3	Ⓢ	40 x 24 1/2 x 28	206	15	(2)16 x 20 x 1

Note: Variable speed furnaces should not be twinned and are not approved for twinning applications.

① Isolated Combustion System. AFUE may vary based on poise.

② Energy Star®.

③ Low stage is equal to 45% for the TUHMD120 model.

④ Field configurable to 24V non-communicating mode.

⑤ Direct drive variable speed motor is an ECM constant airflow blower motor.

⑥ Silicon Nitride Igniter.

⑦ Must use communicating thermostat with ComfortLink™ II control.

* Information subject to change. Please confirm with current Product Data/Service Facts for current factory production.

** For Upflow furnaces, the size is for a bottom return filter.

Furnaces



It's Hard To Stop A Trane.®

XC95m Convertible Gas Furnaces

Airflow Directions:

Downflow models when placed in horizontal position provide left to right airflow. Upflow models when placed in horizontal position provide right to left airflow.

Table FUR-8-A – Features

	XC95m TUHM/TDHM Modulating 1 or 2 Pipe Variable Speed
• Comfort-R™ enhanced mode (cooling)	✓
• ComfortLink™ II system①.....	✓
• Meets requirements for 2% or less air leakage.....	✓
• Adjustable heating fan off timing	✓
• Alternate bottom/left/right return air (upflow models only)	✓
• Blower door safety switch	✓
• Bottom panel (upflow models only).....	✓
• Cleanable/Reusable high velocity filters	✓
• Complete front service access	✓
• Direct drive, variable speed ECM blower motor**	✓
• Downflow horizontal right (downflow models only).....	✓
• Dual PVC pipe venting (1 or 2 pipe option).....	✓
• Modulating gas valve and regulator.....	✓
• Gasketed blower door (upflow models only)	✓
• Heavy gauge reinforced wrap-around steel cabinet	✓
• Humidifier/EAC hook-up capability.....	✓
• Inner blower door panel (downflow models only).....	✓
• Insulated blower compartment 4 sides.....	✓
• Integrated solid state control w/self diagnostics.....	✓
• Left/right condensate drain capability in vertical application	✓
• Service diagnostics with faults reported at the user interface	✓
• Lite Port™/Stored diagnostics	✓
• Manual reset flame roll out switches.....	✓
• Multi-port in shot burners.....	✓
• Service diagnostic capabilities	✓
• Side return duct starter tabs (upflow models only)	✓
• Silicon Nitride hot surface igniter.....	✓
• Slide out blower assembly	✓
• Solid burner door (quiet operation).....	✓
• 20 gauge aluminized steel heat exchanger.....	✓
• 24 volt secondary fuse.....	✓
• Multiple heating blower speeds.....	✓
• Type 29-4C™ stainless steel secondary heat exchanger	✓
• Upflow horizontal left (upflow models only).....	✓
• Variable speed venter motor.....	✓
• Limited lifetime heat exchanger warranty & 10-year on all other functional parts with registration (Residential Use)②.....	✓
• Optional extended warranties available	✓

Note: Variable speed furnaces should not be twinned and are not approved for twinning applications.

① Field configurable to 24V non-communicating mode.

② Registered Limited Warranty terms are available when you register within 60 days of installation. You can register online at Trane.com or by phone at 855-260-2975, otherwise Trane's Base Limited Warranty terms will apply. Base Limited Warranty information on specific products can be found on ComfortSite.com.

**Constant airflow ECM (electronically commutated motor).

Furnaces



It's Hard To Stop A Trane.®

XC95m Convertible Gas Furnaces

Airflow Directions:

Downflow models when placed in horizontal position provide left to right airflow. Upflow models when placed in horizontal position provide right to left airflow.

Table FUR-9-A – Optional Accessories

Model Number	Description	Shipping Weight	XC95m TUHM/TDHM Modulating 1 or 2 Pipe Variable Speed
BAYBASE205.....	Downflow subbase for downflow models only	8.....	✓
BAYFLTR200.....	External side filter rack.....	5.....	✓
BAYFLTR317①.....	Cleanable filter for 17.5" cabinet upflow only.....	2.....	✓
BAYFLTR321①.....	Cleanable filter for 21" cabinet upflow only	2.....	✓
BAYFLTR324①.....	Cleanable filter for 24.5" cabinet upflow only.....	2.....	✓
BAYLPKT220B.....	Propane conversion kit	2.....	✓
BAYLPSS220C.....	LP Kit with Stainless Steel Burners	2.....	✓
BAYRACK960A③.....	Filter rack kit for upflow models only (internal)②.....	5.....	✓
BAYAIR30AVENTA.....	Concentric vent kit for 2, 2½ and 3" vent system	11.....	✓
BAYAIR30CNVENT.....	Concentric vent kit for 2, 2½ and 3" vent system for Canadian applications	11.....	✓
BAYVENT200B.....	Sidewall vent Termination Kit fo Direct vent furnaces.....	2.....	✓
BAYVENTCN200B.....	Sidewall vent Termination Kit fo Direct vent furnaces for Canadian applications.....	2.....	✓
BAYVENT500A.....	Side vent kit for downflow models only	3.....	TDHM
BAYACCECOMM101.....	CleanEffects™ hookup kit for communicating furnaces.....	1.....	✓

Note: Variable speed furnaces should not be twinned and are not approved for twinning applications.

- ① Contains one (1) high velocity filter.
- ② Internal filter rack for side or bottom return air. Includes 17 x 25" cleanable filter for use in side return applications. Bottom return applications require different sizes of filters which are not included. Airflow requirements over 1800 CFM require filters on both sides or a side and bottom or bottom only.
- ③ BAYRACK960A not allowed on right side return on TUH2B080A9V4V** models.

Furnaces

Special Use Furnace Accessories

Table FUR-9-A – High Altitude Pressure Switch 90%

Model Number	Description	Used With	Shipping Weight
BAYSWT07AHALTA	1 Switch	TUHMB060, TDHMB060	2
BAYSWT08AHALTA	1 Switch	TUHMD120, TDHMD120	2
BAYSWT09AHALTA	1 Switch	TUHMB080, TDHMB080, TUHMC100, TDHMC100	2

For complete equipment / combination selections, installation instructions and warranty information, please refer to Product Data/Ratings and/or Installers Guides and Limited Warranty Handbooks.

S8V2-C – Two Stage Communicating ECM Variable Speed

Table FUR-10L-A – S8V2-PC 2 Stage, Upflow/Downflow/Horizontal Left/Horizontal Right, Non-Condensing, Induced Draft Gas Furnace (120/1/60)②

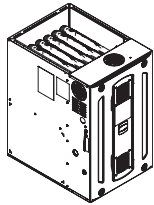

S8V2-C
2-Stage

Unit Model Number	Airflow In Tons	Output (Btuh)		ICS① AFUE	Flue Size (in)	Ignition Device	Uncrated Dimensions (in.) H x W x D	Shipping Weight (lbs.)	Max Fuse*	Filter Sizes**
		Stage 2	Stage 1							
S8V2A040M3PCAA	2-3	32,200	21,000	80	4	③	34 x 14.5 x 28.75	102	15	14 x 25 x 1
S8V2B060M4PCAA	3-4	49,100	31,300	80	4	③	34 x 17.5 x 28.75	132	15	16 x 25 x 1
S8V2B080M4PCAA	3-4	65,800	41,200	80	4	③	34 x 17.5 x 28.75	137	15	16 x 25 x 1
S8V2C080M5PCAA	4-5	64,800	41,800	80	4	③	34 x 21 x 28.75	142	15	20 x 25 x 1
S8V2C100M5PCAA	4-5	81,200	52,300	80	4	③	34 x 21 x 28.75	144	15	20 x 25 x 1
S8V2D120M5PCAA	4-5	98,000	67,900	80	4	③	34 x 24.5 x 28.75	160	15	24 x 25 x 1
Low NOx Models ④										
S8V2A040M3PDAA	2-3	32,200	21,000	80	4	③	34 x 14.5 x 28.75	102	15	14 x 25 x 1
S8V2B060M4PDAA	3-4	49,100	31,300	80	4	③	34 x 17.5 x 28.75	132	15	16 x 25 x 1
S8V2B080M4PDAA	3-4	65,800	41,200	80	4	③	34 x 17.5 x 28.75	137	15	16 x 25 x 1
S8V2C080M5PDAA	4-5	64,800	41,800	80	4	③	34 x 21 x 28.75	142	15	20 x 25 x 1
S8V2C100M5PDAA	4-5	81,200	52,300	80	4	③	34 x 21 x 28.75	144	15	20 x 25 x 1
S8V2D120M5PDAA	4-5	98,000	67,900	80	4	③	34 x 24. x 28.75	160	15	24 x 25 x 1

① IICS - Isolated Combustion System

② Direct drive variable speed blower motor is an ECM constant airflow blower motor.

③ Silicon Nitride Igniter

④ These models comply with 40ng/J Low NOx regulations.

* Information subject to change. Please confirm with current Product Data/Service Facts for current factory production.

** Filters are not shipped with furnace

HUB & Sensor and UI (TLINK360A2VBUA) must be ordered to operate in Link communicating mode.

S8X2 – Two Stage ECM

Table FUR-10-A – S8X2 2 Stage, Upflow/Downflow/Horizontal Left/Horizontal Right, Non-Condensing, Induced Draft Gas Furnace (120/1/60)②

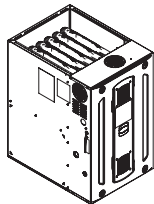

S8X2
4-Way
Multi-Poise

Unit Model Number	Airflow In Tons	Output (Btuh)		ICS① AFUE	Flue Size (in)	Ignition Device	Uncrated Dimensions (in.) H x W x D	Shipping Weight (lbs.)	Max Fuse*	Filter Sizes**
		Stage 2	Stage 1							
S8X2A040M3PSCA	2-3	32,200	20,900	80.0	4	③	34 x 14 ¹ / ₂ x 28 ³ / ₄	102	15	14 x 25 x 1
S8X2B060M4PSCA	4	48,700	31,500	80.0	4	③	34 x 17 ¹ / ₂ x 28 ³ / ₄	132	15	16 x 25 x 1
S8X2B080M4PSCA	3-4	65,000	42,500	80.0	4	③	34 x 17 ¹ / ₂ x 28 ³ / ₄	137	15	16 x 25 x 1
S8X2C080M5PSCA	4-5	64,900	41,800	80.0	4	③	34 x 21 x 28 ³ / ₄	142	15	20 x 25 x 1
S8X2C100M5PSCB	4-5	80,600	52,300	80.0	4	③	34 x 21 x 28 ³ / ₄	144	15	20 x 25 x 1
S8X2D120M5PSCA	5	98,000	67,800	80.0	4	③	34 x 24 ¹ / ₂ x 28 ³ / ₄	160	15	24 x 25 x 1
Low NOx Models ④										
S8X2A040M3PTCA	2-3	32,200	20,900	80.0	4	③	34 x 14 ¹ / ₂ x 28 ³ / ₄	102	15	14 x 25 x 1
S8X2B060M4PTCA	4	48,700	31,500	80.0	4	③	34 x 17 ¹ / ₂ x 28 ³ / ₄	132	15	16 x 25 x 1
S8X2B080M4PTCA	3-4	65,000	42,500	80.0	4	③	34 x 17 ¹ / ₂ x 28 ³ / ₄	137	15	16 x 25 x 1
S8X2C080M5PTCA	4-5	64,900	41,800	80.0	4	③	34 x 21 x 28 ³ / ₄	142	15	20 x 25 x 1
S8X2C100M5PTCB	4-5	80,600	52,300	80.0	4	③	34 x 21 x 28 ³ / ₄	144	15	20 x 25 x 1
S8X2D120M5PTCA	5	98,000	67,800	80.0	4	③	34 x 24 ¹ / ₂ x 28 ³ / ₄	160	15	24 x 25 x 1

① Isolated Combustion System.

② 9 Speed direct drive motor is an ECM constant torque motor.

③ Silicon Nitride Igniter.

④ These models comply with California 40ng/J Low NOx regulations.

* Information subject to change. Please confirm with current Product Data/Service Facts for current factory production.

** Filters are not shipped with furnace.

S8X1 – Single Stage ECM

Table FUR-11-B — S8X1 1 Stage, Upflow/Downflow/Horizontal Left/Horizontal Right, Non-Condensing, Induced Draft Gas Furnace (120/1/60)②

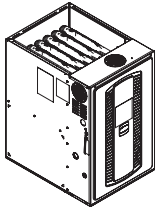

**S8X1
4-Way
Multi-Poise**

Unit Model Number	Airflow In Tons	Nominal Output (Btuh)	ICS① AFUE	Flue Size (in)	Ignition Device	Uncrated Dimensions (in.) H x W x D	Shipping Weight (lbs.)	Max Fuse*	Filter Sizes**
S8X1A026M2PSCA	2	21,000	80.0	4	③	34 x 14 ¹ / ₂ x 28 ³ / ₄	102	15	14 x 25 x 1
S8X1A040M3PSCA	2-3	32,300	80.0	4	③	34 x 14 ¹ / ₂ x 28 ³ / ₄	102	15	14 x 25 x 1
S8X1B040M2PSCA	2	32,500	80.0	4	③	34 x 17 ¹ / ₂ x 28 ³ / ₄	128	15	16 x 25 x 1
S8X1B060M4PSCA	4	48,700	80.0	4	③	34 x 17 ¹ / ₂ x 28 ³ / ₄	132	15	16 x 25 x 1
S8X1B080M4PSCA	3-4	65,100	80.0	4	③	34 x 17 ¹ / ₂ x 28 ³ / ₄	137	15	16 x 25 x 1
S8X1C080M5PSCA	4-5	64,700	80.0	4	③	34 x 21 x 28 ³ / ₄	142	15	20 x 25 x 1
S8X1C100M5PSCB	4-5	80,700	80.0	4	③	34 x 21 x 28 ³ / ₄	144	15	20 x 25 x 1
S8X1D120M5PSCA	5	98,000	80.0	4	③	34 x 24 ¹ / ₂ x 28 ³ / ₄	160	15	24 x 25 x 1
Low NOx Models ④									
S8X1A026M2PTCA	2	21,000	80.0	4	③	34 x 14 ¹ / ₂ x 28 ³ / ₄	102	15	14 x 25 x 1
S8X1A040M3PTCA	2-3	32,300	80.0	4	③	34 x 14 ¹ / ₂ x 28 ³ / ₄	102	15	14 x 25 x 1
S8X1B040M2PTCA	2	32,500	80.0	4	③	34 x 17 ¹ / ₂ x 28 ³ / ₄	128	15	16 x 25 x 1
S8X1B060M4PTCA	4	48,700	80.0	4	③	34 x 17 ¹ / ₂ x 28 ³ / ₄	132	15	16 x 25 x 1
S8X1B080M4PTBA	3-4	65,100	80.0	4	③	34 x 17 ¹ / ₂ x 28 ³ / ₄	137	15	16 x 25 x 1
S8X1C080M5PTCA	4-5	64,700	80.0	4	③	34 x 21 x 28 ³ / ₄	142	15	20 x 25 x 1
S8X1C100M5PTCB	4-5	80,700	80.0	4	③	34 x 21 x 28 ³ / ₄	144	15	20 x 25 x 1
S8X1D120M5PTCA	5	98,000	80.0	4	③	34 x 24 ¹ / ₂ x 28 ³ / ₄	160	15	24 x 25 x 1

① Isolated Combustion System.

② 9 Speed direct drive motor is an ECM constant torque motor.

③ Silicon Nitride Igniter.

④ These models comply with California 40ng/J Low NOx regulations.

* Information subject to change. Please confirm with current Product Data/Service Facts for current factory production.

** Filters are not shipped with furnace.

S8B1 – Single Stage ECM

Table FUR-11-A — S8B1 1 Stage, Upflow/Downflow/Horizontal Left/Horizontal Right, Non-Condensing, Induced Draft Gas Furnace (120/1/60)②

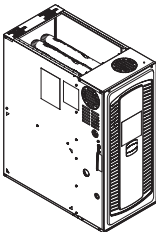

**S8B1
4-Way
Multi-Poise**

Unit Model Number	Airflow In Tons	Nominal Output (Btuh)	ICS① AFUE	Flue Size (in)	Ignition Device	Uncrated Dimensions (in.) H x W x D	Shipping Weight (lbs.)	Max Fuse*	Filter Sizes**
S8B1A026M2PSCA	2	21,000	80.0	4	③	34 x 14 ¹ / ₂ x 28 ³ / ₄	102	15	14 x 25 x 1
S8B1A040M3PSCA	2-3	32,300	80.0	4	③	34 x 14 ¹ / ₂ x 28 ³ / ₄	102	15	14 x 25 x 1
S8B1B040M2PSCA	2	32,500	80.0	4	③	34 x 17 ¹ / ₂ x 28 ³ / ₄	128	15	16 x 25 x 1
S8B1B060M4PSCA	4	48,700	80.0	4	③	34 x 17 ¹ / ₂ x 28 ³ / ₄	132	15	16 x 25 x 1
S8B1B080M4PSCA	3-4	65,100	80.0	4	③	34 x 17 ¹ / ₂ x 28 ³ / ₄	137	15	16 x 25 x 1
S8B1C080M5PSCA	4-5	64,700	80.0	4	③	34 x 21 x 28 ³ / ₄	142	15	20 x 25 x 1
S8B1C100M5PSCB	4-5	80,700	80.0	4	③	34 x 21 x 28 ³ / ₄	144	15	20 x 25 x 1
S8B1D120M5PSCA	5	98,000	80.0	4	③	34 x 24 ¹ / ₂ x 28 ³ / ₄	160	15	24 x 25 x 1
Low NOx Models ④									
S8B1A026M2PTCA	2	21,000	80.0	4	③	34 x 14 ¹ / ₂ x 28 ³ / ₄	102	15	14 x 25 x 1
S8B1A040M3PTCA	2-3	32,300	80.0	4	③	34 x 14 ¹ / ₂ x 28 ³ / ₄	102	15	14 x 25 x 1
S8B1B040M2PTCA	2	32,500	80.0	4	③	34 x 17 ¹ / ₂ x 28 ³ / ₄	128	15	16 x 25 x 1
S8B1B060M4PTCA	4	48,700	80.0	4	③	34 x 17 ¹ / ₂ x 28 ³ / ₄	132	15	16 x 25 x 1
S8B1B080M4PTCA	3-4	65,100	80.0	4	③	34 x 17 ¹ / ₂ x 28 ³ / ₄	137	15	16 x 25 x 1
S8B1C080M5PTCA	4-5	64,700	80.0	4	③	34 x 21 x 28 ³ / ₄	142	15	20 x 25 x 1
S8B1C100M5PTCB	4-5	80,700	80.0	4	③	34 x 21 x 28 ³ / ₄	144	15	20 x 25 x 1
S8B1D120M5PTCA	5	98,000	80.0	4	③	34 x 24 ¹ / ₂ x 28 ³ / ₄	160	15	24 x 25 x 1

① Isolated Combustion System.

② 9 Speed direct drive motor is an ECM constant torque motor.

③ Silicon Nitride Igniter.

④ These models comply with California 40ng/J Low NOx regulations.

* Information subject to change. Please confirm with current Product Data/Service Facts for current factory production.

** Filters are not shipped with furnace.

Convertible Gas Furnaces

Table FUR-12-A – Features

	S8V2-C 2 Stage	S8X2 2 Stage	S8X1 1 Stage	S8B1 1 Stage
• Trane® Link™ Communicating Capability	✓	—	—	—
• Can be connected in communicating or 24V non-communicating modes	✓	—	—	—
• High Efficiency, Variable Speed Constant Airflow blower motor	✓	—	—	—
• Two stage combination gas valve and regulator	✓	✓	—	—
• Dry contact Humidifier/EAC hook-up capability	✓	✓	✓	—
• Insulated blower compartment	✓	✓	✓	—
• Meets requirements for 1% or less air leakage 2	✓	✓	✓	—
• Direct drive, 9 speed Constant Torque ECM blower motor	—	✓	✓	—
• Painted cabinet two tone color	✓	✓	✓	✓
• Standard 34" height	✓	✓	✓	✓
• 4 Way poise (Upflow, Downflow, Horizontal Left, Horizontal Right)	✓	✓	✓	✓
• Front service access with easily accessible burners, sensors, orifices, switches, and other components...	✓	✓	✓	✓
• Cabinet has no knockouts - Plastic plugs come installed from factory	✓	✓	✓	✓
• Gas can enter either side of cabinet	✓	✓	✓	✓
• Multiple venting options - Every model, every size offers two venting options	✓	✓	✓	✓
• Integrated Furnace Control board with digital configuration, status, and fault codes	✓	✓	✓	✓
• Alpha-numeric diagnostic codes	✓	✓	✓	✓
• Adjustable blower off delay for heating and cooling	✓	✓	✓	✓
• Last six fault codes are stored (even with power loss)	✓	✓	✓	✓
• Aluminized heat exchanger tubes	✓	✓	✓	✓
• Longer IFC wire harnesses allow door to be removed without disconnecting the harness	✓	✓	✓	✓
• Alternate bottom/left/right return air (except downflow)	✓	✓	✓	✓
• Bottom panel	✓	✓	✓	✓
• Heavy gauge reinforced wrap-around steel cabinet	✓	✓	✓	✓
• Service diagnostics with faults reported on IFC board	✓	✓	✓	✓
• Manual reset flame roll out switches	✓	✓	✓	✓
• Multi-port in shot burners	✓	✓	✓	✓
• Service diagnostic capabilities	✓	✓	✓	✓
• Vortica™ II blower housing	✓	✓	✓	✓
• Slide out blower assembly on full-length rails	✓	✓	✓	✓
• Side return duct starter tabs	✓	✓	✓	✓
• Silicon Nitride 120V hot surface igniter	✓	✓	✓	✓
• Multiple heating blower speeds	✓	✓	✓	✓
• Limited Lifetime warranty on the heat exchanger & 10-year on all other functional parts with registration (Residential Use)	✓	—	—	—
• 20-year limited warranty on the heat exchanger & 10-year on all other functional parts with registration (Residential Use)*	—	✓	✓	✓
• Optional extended warranties available	✓	✓	✓	✓

① 14.5" cabinets do not have blower compartment insulation

* Registered Limited Warranty terms are available when you register within 60 days of installation. You can register online at Trane.com or by phone at 855-260-2975, otherwise Trane's Base Limited Warranty terms will apply. Base Limited Warranty information on specific products can be found on ComfortSite.com.

Table FUR-12-B – Optional Accessories

Model Number	Description	Shipping Weight	S8V2-C 2 Stage	S8X2 2 Stage	S8X1 1 Stage	S8B1 1 Stage
BAYLPSS400C	LP Kit with Stainless Steel Burners	3	✓	✓	(except 026)	(except 026)
BAYLPSS410B	LP Kit with Stainless Steel Burners	3	✓	—	S8X1A026	S8B1A026
BAYHANG	Horizontal hanging kit	2	—	✓	✓	✓
BAYSF1165A	1" SlimFit Box with MERV 4 Filter (side return)	5	✓	✓	✓	✓
BAYVENT600A	Internal venting kit	11	✓	✓	✓	✓
BAYVENT800B	Masonry Chimney Vent Kit	11	✓	✓	✓	✓
PIP02095	U fitting for gas piping	1	✓	✓	✓	✓
BAYLIFTB	Dual return kit. B cabinet size extension	8	✓	✓	✓	✓
BAYLIFTC	Dual return kit. C cabinet size extension	9	✓	✓	✓	✓
BAYLIFTD	Dual return kit. D cabinet size extension	9	✓	✓	✓	✓
BAYBASE205	Downflow subbase	8	✓	✓	✓	✓
BAYFLTR206	Filter Access Door Kit (Downflow only)	2	✓	✓	✓	✓
BAYSF1165	16x20 1" side return filter rack	✓	✓	✓	✓	✓
BAYSF1255	16x25 1" side return filter rack (bottom return for 17.5" cabinets)	✓	✓	✓	✓	✓
BAYBURNERSS	Stainless steel natural gas burner kit	✓	✓	✓	✓	✓
BAYFURNPTKT	Optional return static sensor	✓	✓	—	—	—
BAYSENSC360	Supply Air Temperature Sensor*	✓	✓	—	—	—

① Compatible with B, C, and D width cabinets.

*Optional in 24v mode



It's Hard To Stop A Trane.®

Convertible Gas Furnaces

Table FUR-13-A — High Altitude Pressure Switch S8 Furnaces

Model Number	Description	Used With	Shipping Weight
BAYSWT14AHALTB	1 Switch	S8X1C080M5PSAB ^① , S8X1C100M5PSAB ^① , S8B1C080M5PSAB ^① , S8B1C100M5PSAB ^①	2
BAYSWT15AHALTA	1 Switch	S8X1B060M3PSAB ^① , S8X1B060M4PSAB ^① , S8X1B080M4PSBA ^① , S8B1B060M3PSAB ^① , S8B1B060M4PSAB ^① , S8B1B080M4PSBA ^①	2
BAYSWT16AHALTA	2 Switches	S8X2C080M5PSAB ^① , S8V2C080M5P*	2
BAYSWT17AHALTA	2 Switches	S8X2B060M3PSAB, S8X2B060M4PSAB	2
BAYSWT18AHALTA	2 Switches	S8X2B080M4PSBA ^① , S8V2B080M4P*	2
BAYSWT19AHALTA	2 Switches	S8X2C100M5PSAB ^① , S8V2C100M5P*	2
BAYSWT20AHALTA	1 Switch	S8X1A026M2PSAB ^① , S8B1A026M2PSAB ^①	2
BAYSWT21AHALTA	1 Switch	S8X1A040M3PSAB ^① , S8X1A040M3PSAB ^① , S8X1B040M2PSAB ^① , S8B1B040M2PSAB ^①	2
BAYSWT22AHALTA	2 Switches	S8X2A040M3PSAB ^① , S8V2A040M3P*	2
BAYSWT23AHALTA	2 Switches	S8X2B060M3PSAB ^② , S8X2B060M4PSA ^② , S8V2B060M4P*	2
BAYSWT24AHALTA	2 Switches	S8V2D120M5P*	2

Note: S8X1D120M5, S8B1D120M5, and S8X2D120M5 do not require high altitude pressure switch kits.

① SAAA & later or TAAA & later

② SAAB & later or TAAA & later

Furnaces

XC80 Convertible Gas Furnace Airflow Directions

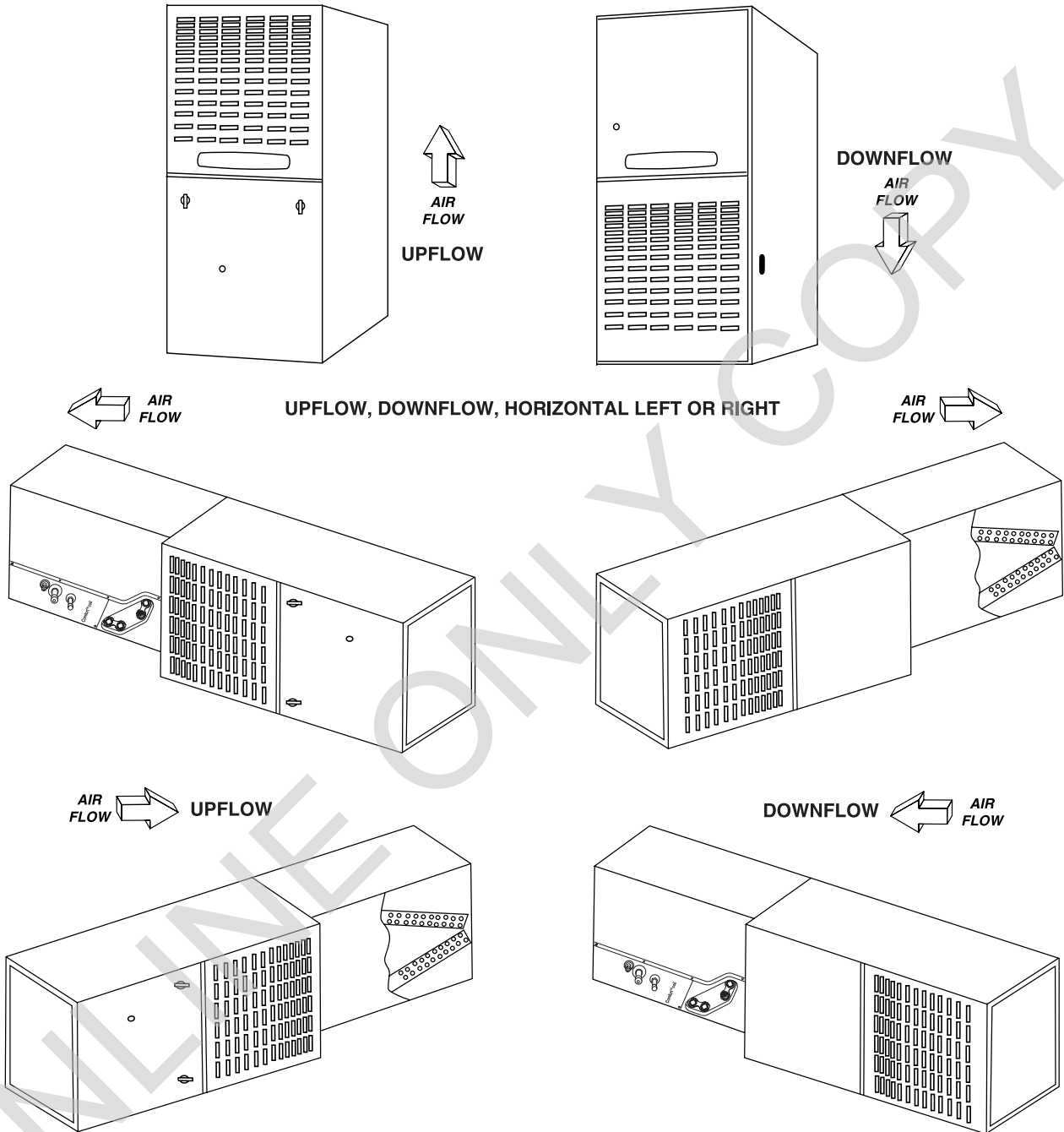

Note: The non-condensing, forty inch (40") height furnaces may be laid on either side for horizontal application. Connection brackets for coil/furnace alignment are included with the furnaces. The apex of the coil may point into or away from the airflow.

XC80 Communicating Two Stage ECM Variable Speed

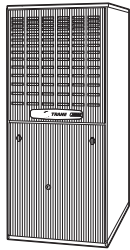

**XC80
Upflow**

Table FUR-15-A — XC80 Variable Speed Communicating, Two-Stage, Upflow/Horizontal Left or Right Induced Draft Gas Furnace (115/1/60)②③④

Unit Model Number	Airflow In Tons	Output (Btuh)		ICS① AFUE	Flue Size (in)	Ignition Device	Uncrated Dimensions (in.) H x W x D	Shipping Weight (lbs.)	Max Fuse*	Filter Sizes**
		Stage 2	Stage 1							
TUD2B060ACV32B	3	48,000	31,200	80.0	4	①	40 x 17½ x 28	136	15	17 x 25 x 1
TUD2B080ACV32B	3	64,000	41,600	80.0	4	①	40 x 17½ x 28	142	15	17 x 25 x 1
TUD2C080ACV42B	4	64,000	41,600	80.0	4	①	40 x 21 x 28	155	15	20 x 25 x 1
TUD2C100ACV52B	5	79,000	52,000	80.0	4	①	40 x 21 x 28	175	15	20 x 25 x 1
TUD2D120ACV52B	5	97,000	62,400	80.0	4	①	40 x 24½ x 28	193	15	24 x 25 x 1
TUD2D140ACV52B	5	111,000	72,800	80.0	4	①	40 x 24½ x 28	197	15	24 x 25 x 1

Table FUR-15-B — XC80 Variable Speed Communicating, Two-Stage, Downflow/Horizontal Left or Right Induced Draft Gas Furnace (115/1/60)②③④

Unit Model Number	Airflow In Tons	Output (Btuh)		ICS① AFUE	Flue Size (in)	Ignition Device	Uncrated Dimensions (in.) H x W x D	Shipping Weight (lbs.)	Max Fuse*	Filter Sizes**
		Stage 2	Stage 1							
TDD2B060ACV32B	3	48,000	31,200	80.0	4	①	40 x 17½ x 28	140	15	(2) 14 x 20 x 1
TDD2B080ACV32B	3	63,000	41,600	80.0	4	①	40 x 17½ x 28	146	15	(2) 14 x 20 x 1
TDD2C100ACV52B	5	81,000	52,000	80.0	4	①	40 x 21 x 28	166	15	(2) 16 x 20 x 1
TDD2D120ACV52B	5	95,000	62,400	80.0	4	①	40 x 24½ x 28	197	15	(2) 16 x 20 x 1

Note: Variable speed furnaces should not be twinned and are not approved for twinning applications.

① Silicon Nitride Igniter.

② Must use communicating thermostat with ComfortLink™ II control.

③ Field convertible to 24V non-communicating.

④ Direct drive variable speed motor is an ECM constant airflow blower motor.

⑤ Isolated Combustion System.

* Information subject to change. Please confirm with current Product Data/Service Facts for current factory production.

** For Upflow furnaces, the size is for a bottom return filter.

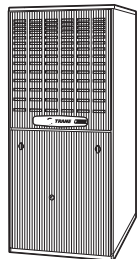

**XC80
Downflow**

Furnaces

XV80 – Two Stage ECM Variable Speed

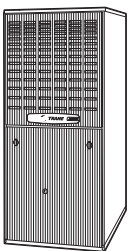

**XV80
Upflow**

Table FUR-15-C — XV80 Upflow/Horizontal Left or Right Induced Draft Gas Furnace (115/1/60) ②

Unit Model Number	Airflow In Tons	Output (Btuh)		ICS③ AFUE	Flue Size (in)	Ignition Device	Uncrated Dimensions (in.) H x W x D	Shipping Weight (lbs.)	Max Fuse*	Filter Sizes**
		Stage 2	Stage 1							
TUD2B060A9V3VB	3	48,000	31,200	80.0	4	Silicon Nitride	40 x 17½ x 28	136	15	17 x 25 x 1
TUD2B080A9V3VB	3	64,000	41,600	80.0	4	Silicon Nitride	40 x 17½ x 28	142	15	17 x 25 x 1
TUD2C080A9V4VB	4	64,000	41,600	80.0	4	Silicon Nitride	40 x 21 x 28	166	15	17 x 25 x 1
TUD2C080B9V4VB①	4	64,000	41,600	80.0	4	Silicon Nitride	40 x 21 x 28	166	15	17 x 25 x 1
TUD2C100A9V5VB	5	79,000	52,000	80.0	4	Silicon Nitride	40 x 21 x 28	166	20	20 x 25 x 1
TUD2C100B9V5VB①	5	79,000	52,000	80.0	4	Silicon Nitride	40 x 21 x 28	166	20	20 x 25 x 1
TUD2D120A9V5VB	5	97,000	62,400	80.0	4	Silicon Nitride	40 x 24½ x 28	193	20	24 x 25 x 1
TUD2D120B9V5VB①	5	97,000	62,400	80.0	4	Silicon Nitride	40 x 24½ x 28	193	20	24 x 25 x 1

Table FUR-15-D — XV80 Downflow/Horizontal Left or Right Induced Draft Gas Furnace (115/1/60) ②

Unit Model Number	Airflow In Tons	Output (Btuh)		ICS③ AFUE	Flue Size (in)	Ignition Device	Uncrated Dimensions (in.) H x W x D	Shipping Weight (lbs.)	Max Fuse*	Filter Sizes**
		Stage 2	Stage 1							
TDD2B060A9V3VA	3	48,000	31,200	80.0	4	Silicon Nitride	40 x 17½ x 28	140	15	(2) 14 x 20 x 1
TDD2B080A9V3VA	3	63,000	41,600	80.0	4	Silicon Nitride	40 x 17½ x 28	146	15	(2) 14 x 20 x 1
TDD2C100A9V5VA	5	81,000	52,000	80.0	4	Silicon Nitride	40 x 21 x 28	166	20	(2) 16 x 20 x 1
TDD2D120A9V5VA	5	95,000	62,400	80.0	4	Silicon Nitride	40 x 24½ x 28	197	20	(2) 16 x 20 x 1

Note: Variable speed furnaces should not be twinned and are not approved for twinning applications.

① Model has high efficiency blower assembly.

② This furnace family uses a two speed draft inducer.

③ Isolated Combustion System.

* Information subject to change. Please confirm with current Product Data/Service Facts for current factory production.

** For Upflow furnaces, the size is for a bottom return filter.



**XV80
Downflow**

XC80, XV80 Convertible Gas Furnaces

Table FUR-16-A – Features

	XC80 TUD2 TDD2 2-Stage ^①	XV80 TUD-9V TDD-9V 2-Stage ^①
• Service diagnostics with faults reported at the user interface.....	✓	✓
• ComfortLink™ II system.....	✓	—
• Can be connected in communicating or 24V non-communicating modes.....	✓	—
• User interface for system configuration - Easy to use navigation buttons and plain text for clear description of features.....	✓	—
• 3-way vent option on downflow models (top,right or left) (downflow models only).....	—	✓
• 24 volt secondary fuse.....	—	✓
• Variable speed ECM blower motor*.....	✓	✓
• Comfort-R™ enhanced mode (cooling).....	✓	✓
• Meets requirements for 2% or less air leakage.....	✓	✓
• Adjustable heating fan off timing.....	✓	✓
• Alternate bottom/left/right return air (upflow models only).....	✓	✓
• Attractive color accents.....	✓	✓
• Blower door safety switch.....	✓	✓
• Bottom Panel (upflow models only).....	✓	✓
• Cleanable/reusable high velocity filters.....	✓	✓
• Common vent capability.....	✓	✓
• Complete front service access.....	✓	✓
• Gasketed blower door.....	✓	✓
• Heavy gauge reinforced wrap-around steel cabinet.....	✓	✓
• Horizontal left/right without conversion required.....	✓	✓
• Humidifier/EAC hook-up capability.....	✓	✓
• Inner blower door panel (downflow models only).....	✓	✓
• Insulated blower compartment 4 sides (upflow models only).....	✓	✓
• Integrated solid state control w/self diagnostics.....	✓	✓
• Left/right gas connection.....	✓	✓
• Manual reset flame roll out switches.....	✓	✓
• Masonry Chimney Venting w/BAYVENT800B (upflow models).....	✓	✓
• Multi-port in shot burners.....	✓	✓
• Perfect fit door latches (upflow models only).....	✓	✓
• Right or left hand side knock out for venting (downflow models only).....	✓	✓
• Selectable cooling fan off delay eliminates need for time delay relay.....	②	✓
• Service diagnostic capabilities.....	✓	✓
• Side return starter tabs (upflow models only).....	✓	✓
• Silicon Nitride hot surface igniter with adaptive heat up.....	✓	✓
• Single door filter access.....	✓	✓
• Slide out blower assembly.....	✓	✓
• 20 gauge aluminized steel heat exchanger.....	✓	✓
• Four heating blower speeds.....	✓	✓
• Two speed venter motor.....	✓	✓
• Two-stage gas valve.....	✓	✓
• Limited lifetime heat exchanger warranty & 10-year on all other functional parts with registration (Residential Use)③.....	✓	✓
• Optional extended warranties available.....	✓	✓

Note: Variable speed furnaces should not be twinned and are not approved for twinning applications.

① Variable Speed

② Selectable through thermostat

③ Registered Limited Warranty terms are available when you register within 60 days of installation. You can register online at Trane.com or by phone at 855-260-2975, otherwise Trane's Base Limited Warranty terms will apply. Base Limited Warranty information on specific products can be found on ComfortSite.com.

*Constant airflow ECM (electronically commutated motor).

XC80, XV80 Convertible Gas Furnaces

Table FUR-17-A — Optional Accessories

Model Number	Description	Shipping Weight	XC80 TUD2 TDD2 2 Stage ^①	XV80 TUD-R-V-K TDD-R-V-F 2 Stage ^③
BAYBASE205.....	Downflow subbase for downflow models only	8.....	✓	✓
BAYFLTR200.....	Side Filter Rack (External)	5.....	✓	✓
BAYFLTR206.....	Filter Access Door Kit (Downflow only)	2.....	✓	✓
BAYFLTR321 ^①	Cleanable filter for 21" cabinet upflow only	2.....	✓	✓
BAYFLTR324 ^①	Cleanable filter for 24.5" cabinet upflow only	2.....	✓	✓
BAYLPKT210B.....	Propane conversion kit.....	1.....	✓	✓
BAYLPSS210B.....	LP Kit with Stainless Steel Burners.....	1.....	✓	✓
BAYRACK960A ^②	Filter Rack Kit for upflow models only (internal)	5.....	✓	✓
BAYVENT800B.....	Masonry chimney vent kit for upflow models only	2.....	✓	✓

Note: Variable speed furnaces should not be twinned and are not approved for twinning applications.

^① Contains one (1) high velocity filter.

^② Internal filter rack for side or bottom return air. Includes 17 x 25" cleanable filter for use in side return applications. Bottom return applications require different sizes of filters which are not included. Airflow requirements over 1800 CFM require filters on both sides or a side and bottom or bottom only.

^③ Variable Speed

Ordering Information

Variable and Non-Variable Speed High Efficiency Oil Furnaces

Trane Oil Furnaces are available from your local distributor.

For availability and support, contact your local distributor.

Furnaces



L8V1 - Single Stage, Variable Speed, Ultra-Low NOx Gas Furnace



Table FUR-19-A — L8V1 - Single Stage, Variable Speed, Ultra-Low NOx Furnace

Model Number	Airflow in Tons	Output (BTUH)	ICS AFUE	Flue Size (in.)	Ignition Device	Uncrated Dimensions (in.)			Shipping Weight (lbs.)	Max. Fuse	Filter Sizes
						H	W	D			
L8V1A040U3VSAA	3	31,700	80	4	Silicon Nitride	34	14 ¹ / ₂	28 ³ / ₄	100	15	14 x 25 x 1
L8V1A060U3VSAA	3	48,100	80	4	Silicon Nitride	34	14 ¹ / ₂	28 ³ / ₄	110	15	14 x 25 x 1
L8V1B080U4VSAA	4	63,000	80	4	Silicon Nitride	34	17 ¹ / ₂	28 ³ / ₄	123	15	16 x 25 x 1
L8V1C100U5VSAA	5	80,200	80	4	Silicon Nitride	34	21	28 ³ / ₄	146	15	20 x 25 x 1

L8X1 - Single Stage, Ultra-Low NOx Gas Furnace



L8X1A055
L8X1B070

Table FUR-19-B — L8X1 - Single Stage, Ultra-Low NOx Gas Furnace

Model Number	Airflow in Tons	Output (BTUH)	ICS AFUE	Flue Size (in.)	Ignition Device	Uncrated Dimensions (in.)			Shipping Weight (lbs.)	Max. Fuse	Filter Sizes
						H	W	D			
L8X1A055U3XSAC	3 ^①	44,000	80.0	4	Silicon Nitride	34 ¹ / ₂	14 ¹ / ₅	28	107	15	14 x 25 x 1
L8X1B070U4XSAC	4	56,000	80.0	4	Silicon Nitride	34 ¹ / ₂	17 ¹ / ₂	28	135	15	16 x 25 x 1



L8X1B060
L8X1B080

Table FUR-19-C — L8X1 - Single Stage, Ultra-Low NOx Gas Furnace

Model Number	Airflow in Tons	Nominal Output (BTUH)	ICS AFUE	Flue Size (in.)	Ignition Device	Uncrated Dimensions (in.)			Shipping Weight (lbs.)	Max. Fuse	Filter Sizes
						H	W	D			
L8X1B060U3XSAA	3	48,000	80.0	4	Silicon Nitride	34	17 ¹ / ₂	28 ³ / ₄	118	15	16 x 25 x 1
L8X1B080U4XSAA	4	64,000	80.0	4	Silicon Nitride	34	17 ¹ / ₂	28 ³ / ₄	125	15	16 x 25 x 1

① Special consideration should be taken in duct design, evaporator coil selection/pressure drop, and air filter selection to achieve 350 CFM/ton at 0.5" external static pressure.

Table FUR-19-D — Features

	L8X1A055 L8X1B070	L8X1B060 L8X1B080	L8V1
• Cabinet height (in.).....	34.5	34.0	34.0
• 3-Way poise (Upflow, Horizontal Left, Horizontal Right).....	✓	✓	✓
• Cabinet has no knockouts.....	—	✓	✓
• Single stage.....	✓	✓	✓
• 5 speed, Constant Torque ECM blower motor.....	✓	✓	—
• High Efficiency, Variable Speed blower motor.....	—	—	✓
• Stainless Steel, Tubular heat exchanger.....	—	✓	✓
• Aluminized Steel, Tubular heat exchanger.....	✓	—	—
• Insulated blower compartment.....	✓	✓	✓
• Vortica™ II Blower Housing.....	—	✓	✓
• Meets requirements for 1% or less cabinet air leakage ^②	—	✓	✓
• Silicon Nitride hot surface igniter.....	✓	✓	✓
• 20-year limited warranty on the heat exchanger and 10-year on all other functional parts with registration*.....	✓	✓	—
• Limited lifetime warranty on the heat exchanger & 10-year on all other functional parts with registration*.....	—	—	✓

② L8X1A055, L8X1B070, L8X1C100 models certified to 2% cabinet air leakage

* Registered Limited Warranty terms are available when you register within 60 days of installation. You can register online at Trane.com or by phone at 855-260-2975, otherwise Trane's Base Limited Warranty terms will apply. Base Limited Warranty information on specific products can be found on ComfortSite.com.

Table FUR-19-E — Optional Accessories

Model Number	Description	L8X1A055 L8X1B070	L8X1B060 L8X1B080	L8V1
BAYSPACER.....	6 inch vertical coil spacer.....	✓	—	—

Table FUR-19-F — High Altitude Kits

Model Number	Description	Used With
BAYHALTMOD0001	High Altitude Kit for units installed between 5400 - 7800 ft.	L8X1B060U3
BAYHALTMOD0002	High altitude kit for units installed between 2000 - 7800 ft.	L8X1B080U4
BAYHALTMOD0004	High altitude kit for units installed between 4001 - 7800 ft.	L8V1C100U5
BAYHALTMOD0005	High altitude kit for units installed between 4001 - 7800 ft.	L8V1A040U3
BAYHALTMOD0006	High altitude kit for units installed between 4001 - 7800 ft.	L8V1A060U3
BAYHALTMOD0007	High altitude kit for units installed between 4001 - 7800 ft.	L8V1B080U4

L9X1 - Single Stage, Ultra-Low NOx Gas Furnace



L9X1

Table FUR-20-A — L9X1 - Single Stage, Ultra-Low NOx Gas Furnace

Model Number	Airflow in Tons	Output (BTUH)	ICS AFUE	Flue Size (in.)	Ignition Device	Uncrated Dimensions (in.)			Shipping Weight (lbs.)	Max. Fuse	Filter Sizes
						H	W	D			
L9X1A050U3VSAB	3	48,000	95	2, 3, 4	Silicon Nitride	34½	14¼	28	115	15	14 x 25 x 1
L9X1B070U4VSAB	4	67,000	95	2, 3, 4	Silicon Nitride	34½	17½	28	133	15	16 x 25 x 1
L9X1C100U5VSAB	5	95,000	95	2, 3, 4	Silicon Nitride	34½	21	28	150	20	20 x 25 x 1

Table FUR-20-B — Features

	L9X1
• 9 speed, Constant Torque ECM blower motor	✓
• 34.5" Cabinet height	✓
• 3-Way Poise (Upflow, Horizontal Left, Horizontal Right).....	✓
• Single Stage Operation	✓
• Aluminized steel, tubular primary heat exchanger	✓
• Stainless steel secondary heat exchanger	✓
• Insulated blower compartment.....	✓
• Meets 14 ng/J NOx emission requirements	✓
• Meets requirements for 2% or less cabinet air leakage	✓
• Limited Lifetime heat exchanger warranty & 10-year on all other functional parts with registration (Residential Use).....	✓

* Registered Limited Warranty terms are available when you register within 60 days of installation. You can register online at Trane.com or by phone at 855-260-2975, otherwise Trane's Base Limited Warranty terms will apply. Base Limited Warranty information on specific products can be found on ComfortSite.com.

Table FUR-20-C — Optional Accessories

Model Number	Description	Used With
BAYSPACER	6 inch vertical coil spacer	L9X1 Furnaces
BAYHANG	Horizontal hanging kit	All Upflow Furnaces
BAYVENT200B	Sidewall Vent Termination Kit	All Condensing Furnaces
BAYAIR30AVENTA	Concentric Vent Kit	All Condensing Furnaces
BAYLIFTC	Dual Return Kit (C size extension)	C Cabinet Upflow Furnaces
BAYCNDTRAP2A	Inline Condensate Trap Kit used with Special Venting on 2" Vent Pipe	All Condensing Furnaces
BAYCNDTRAP3A	Inline Condensate Trap Kit used with Special Venting on 3" Vent Pipe	All Condensing Furnaces



It's Hard To Stop A Trane.®

Trane CleanEffects™ Whole House Air Cleaner



Trane CleanEffects™ Whole House Air Cleaner:

- Trane CleanEffects™ removes up to 99.98% of allergens from the filtered air
- Removes particles down to 0.3 micron in size
- CleanEffects® Whole Home Air Cleaner removes more than 99% of the surrogate for the virus that causes COVID-19 within 30 minutes.
- Outperforms HEPA type filters, and up to 100 times more effective than a standard 1" filter
- Constructed of painted 18 gage metal to protect the filter and internal electronics
- Power door provides easy access to internal components and features a filter status display as well as safety interlocks that automatically shut down the power when the door is opened for maintenance or cleaning
- Designed for flush fit on both sides and rear of equipment cabinet
- No transitions required on Trane CleanEffects™ applications
- Gaskets included with the air cleaner
- ComfortLink II™ communicating or 24 volt capability
- 10-Year Limited Warranty with registration*
- Trane CleanEffects™ certified as **asthma & allergy friendly™** by AAFA (Asthma and Allergy Foundation of America)
- Zero ozone emissions. Cleaner air without harmful ozone byproducts so you can breathe easier

Table IAQ-1-A – Air Handler – 24 Volt Trane CleanEffects™ Whole House Air Cleaner

Model Number	Airflow Range	Trane CleanEffects™ Air Handler Width	Uncrated Dimensions (in.) H x W x D	Shipping Weight
EFD175DLAH000B	300-1200	17½ inch	7½ x 17½ x 21	37
EFD215DLAH000B	300-1200	21½ inch	7½ x 21½ x 21	42
EFD235DLAH000B	350-1600	23½ inch	7½ x 23½ x 21	44

Table IAQ-1-B – Upflow / Side Return Furnace – 24 Volt Trane CleanEffects™ Whole House

Model Number	Airflow Range	Trane CleanEffects™ Furnace Width	Uncrated Dimensions (in.) H x W x D	Shipping Weight
EFD145DLFR000B	300-1200	14½ inch ^①	7½ x 14½ x 27	39
EFD175DLFR000B	300-1600	17½ inch ^①	7½ x 17½ x 27	43
EFD210DLFR000B	300-2000	21 inch ^②	7½ x 21 x 27	47
EFD245DLFR000B	400-2000	24½ inch ^②	7½ x 24½ x 27	49

Table IAQ-1-C – Downflow Furnace – 24 Volt Trane CleanEffects™ Whole House

Model Number	Airflow Range	Trane CleanEffects™ Furnace Width	Uncrated Dimensions (in.) H x W x D	Shipping Weight
EFD17DDLFR000B	300-1600	17½ inch	7½ x 17½ x 21	37
EFD21DDLFR000B	300-2000	21 inch	7½ x 21 x 21	41

Table IAQ-1-D – Accessories – Trane CleanEffects™ Whole House

Model Number	Description	Used With	Shipping Weight
BAYTRANS12024	120 to 24 Volt Transformer	All EFD Air Cleaners	6

- ① Side return no transition required.
- ② Side return transition required.

Table IAQ-1-E – Air Handler Filters

ifD Filter	AIR HANDLER MODEL NUMBER	
	A	B
EFD175	17½	15
EFD215	21½	19
EFD235	23½	21

Table IAQ-1-G – Downflow Furnace Filters

ifD Filter	FURNACE MODEL NUMBER	
	A	B
EFD17D	17½	14 ⁷ / ₈
EFD21D	21	18 ³ / ₈
EFD24D	24½	21 ⁷ / ₈

Table IAQ-1-F – Upflow Furnace Filters

ifD Filter	FURNACE MODEL NUMBER	
	A	B
EFD145	14½	12
EFD175	17½	15
EFD210	21	18½
EFD245	24½	22

* Registered Limited Warranty terms are available when you register within 60 days of installation. You can register online at Trane.com or by phone at 855-260-2975, otherwise Trane's Base Limited Warranty terms will apply. Base Limited Warranty information on specific products can be found on ComfortSite.com.

For complete equipment / combination selections, installation instructions and warranty information, please refer to Product Data/Ratings and/or Installers Guides and Limited Warranty Handbooks.



It's Hard To Stop A Trane.®

Perfect Fit™ Filter Accessories

Table IAQ-2-A – Furnace Cartridge Media

Model Number	Description	Qty	Enclosure Used with	Shipping Weight
BAYFTFREXM2	Expandable 5" Cartridge Media Filter	2 / Box	14 1/2 - 24 1/2 x 27	5

Table IAQ-2-B – Air Handler Cartridge Media

Model Number	Description	Qty	Enclosure Used with	Shipping Weight
BAYFTAHEXM2	Expandable 5" Cartridge Media Filter	2 / Box	21 1/2 - 26 x 21	5



SlimFit Filters

- Available in cabinet widths for the TEM Air Handlers.
- Available for the S-Series Furnaces with side return.
- Polyslate Gray 18 gauge steel painted frame to match cabinet
- Low profile 2" depth cabinet
- Hinged front door for easy filter replacement
- MERV 4 rated pleated filter included for recurring revenue on SlimFit sizes. Will also accommodate off the shelf retail filters.
- Easy Installation with only 4 screws and included gasket.
- Fully insulated R-4.2 door
- Insulated cabinet to prevent sweating

Table IAQ-2-E - SlimFit Filters

Part Number	Part Description	Dimensions (in.)
BAYSF1165BAA	1" Filter and Frame (Side Return Furnace)	16 ⁵ / ₈ x 20 ³ / ₈ x 2
BAYSF1185BAA	1" Filter and Frame, 18 ¹ / ₂	18 ¹ / ₂ x 21 x 2
BAYSF1235BAA	1" Filter and Frame, 23 ¹ / ₂	23 ¹ / ₂ x 21 x 2
BAYSF11255BAA	1" Filter and Frame (Side Return Furnace)	16 ⁵ / ₈ x 25 ¹ / ₂ x 2
FLRSF1165*	1" Media Filter (Side Return Furnace)	16 ¹ / ₄ x 20 ¹ / ₄ x ³ / ₄
FLRSF1185*	1" Media Filter	17 ³ / ₄ x 19 ³ / ₄ x ³ / ₄
FLRSF1235*	1" Media Filter	22 ³ / ₄ x 19 ³ / ₄ x ³ / ₄
FLRSF1255*	1" Media Filter (Side Return Furnace)	16 ¹ / ₄ x 25 ¹ / ₄ x ³ / ₄
FLRSF1265*	1" Media Filter	25 ³ / ₄ x 19 ³ / ₄ x ³ / ₄

*Shipped in cartons of 12

Indoor Air Quality



It's Hard To Stop A Trane.®

QuikBox™ Media Cabinet and Filters

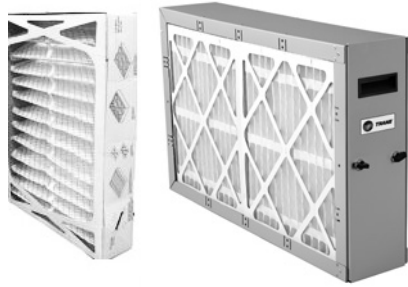

- New Cost Improved Replacement for TFM Perfect Fit Media Filter
- 7 Perfect Fit Sizes to match Air Handler or Furnace Cabinet dimensions
- 5" Depth Metal Painted Cabinet with fully insulated R-4.2 Door
- MERV 11 and MERV 13 solutions available
- Space saving collapsible "shirt box" style filter design
- Air Tite Door Construction with Gasketing and Quarter Turn Easy Open Latch
- Cabinet Gasketing included for improved leakage at equipment connection
- QuikBox Replacement Filters are Backward Compatible to Fit Every TFM FilterBox

Table IAQ-3-A– QuikBox™ Cabinet with Filter

MERV 11	MERV 13	Nominal Cabinet Size (HxWxD)	Airflow Range CFM	Shipping Weight	Older Perfect Fit Model
EQBFM175A1FR11	EQBFM175A0FR13	5" x 17.5" x 27"	300-1500	20	TFM175B0FR0
EQBFM17DA1AH11	EQBFM17DA0AH13	5" x 17.5" x 21"	300-1600	20	TFM17DA0FR0
EQBFM210A1FR11	EQBFM210A0FR13	5" x 21.0" x 27"	300-2000	22	TFM210B0FR0
EQBFM215A1AH11	EQBFM215A0AH13	5" x 21.5" x 21"	300-1400	20	TFM215B0AH0
EQBFM235A1AH11	EQBFM235A0AH13	5" x 23.5" x 21"	300-1700	22	TFM235B0AH0
EQBFM245A1FR11	EQBFM245A0FR13	5" x 24.5" x 27"	400-2000	24	TFM245B0FR0
EQBFM185A1AH11	EQBFM185A0AH13	5" x 18.5" x 21"	400-1600	22	N/A

Table IAQ-3-B– QuikBox™ Replacement Filters

QuikBox Model	QuikBox MERV 11 Filter Part Number	QuikBox MERV 13 Filter Part Number	Dimensions (in.)	Perfect Fit Model	Old Filter Part Number
OBSOLETE	FLRQB5FR14M11	FLRQB5FR14M13	13.7 x 26 x 4.7	TFM145B0FR0	BAYFTFR14M2
EQBFM175A1FR11	FLRQB5FR17M11	FLRQB5FR17M13	16.7 x 26 x 4.7	TFM175B0FR0	BAYFTFR17M2
EQBFM210A1FR11	FLRQB5FR21M11	FLRQB5FR21M13	20.2 x 26 x 4.7	TFM210B0FR0	BAYFTFR21M2
EQBFM245A1FR11	FLRQB5FR24M11	FLRQB5FR24M13	23.7 x 26 x 4.7	TFM245B0FR0	BAYFTFR24M2
EQBFM17DA1AH11	FLRQB5DN17M11	FLRQB5DN17M13	16.7 x 20 x 4.7	TFM17DA0FR0	BAYFTDN17M2

Table IAQ-3-C– QuikBox™ Replacement Filters

QuikBox Model	QuikBox MERV 11 Filter Part Number	QuikBox MERV 13 Filter Part Number	Dimensions (in.)	Perfect Fit Model	Old Filter Part Number
EQBFM215A1AH11	FLRQB5AH21M11	FLRQB5AH21M13	20.7 x 20 x 4.7*	TFM215B0AH0	BAYFTAH21M2
EQBFM235A1AH11	FLRQB5AH23M11	FLRQB5AH23M13	22.7 x 20 x 4.7	TFM235B0AH0	BAYFTAH23M2
EQBFM260A1AH11	FLRQB5AH26M11	FLRQB5AH26M13	25.2 x 20 x 4.7	TFM260B0AH0	BAYFTAH26M2
EQBFM185A1AH11	FLRQB5AH18M11	FLRQB5AH18M13	17.75 x 20 x 4.7	N/A	N/A

* Note:
Fits phased out TFM21DAFR0 Perfect Fit Cabinet

Indoor Air Quality



It's Hard To Stop A Trane.®



Humidifiers Steam

Steam Humidifier w/ Manual Control

- Electrode Type Steam Canister means fast, easy, low cost maintenance.*
- Six Different Capacities In One Unit to satisfy any application from 11.5 gallons per day to 34.6 gallons per day.
- Automatic Shut Down after 72 hours of inactivity; unit will drain to eliminate standing water.
- Easy Mounting Flexibility to your existing duct work or can be remotely mounted.
- Choose Precise Relative Humidity % Settings based on your needs and outdoor conditions. Works with Trane Home-enabled controls without the need for

- additional controls.
- Humidity “On Demand” uses your HVAC system blower to distribute humidified air throughout your home without a call for heating from your furnace or heat pump.
- 10-Year Registered Limited Warranty includes all functional Parts.**
- All Inclusive Package means there is nothing else to purchase. Includes manual humidistat and blower relay. Trane Home-enabled control is optional.

*Replace once a year

Steam Humidifier Low Conductivity w/ Manual Control

- Trane® model 800LC Steam Humidifier is recommended for all 120V installations.
- Two Different Capacities at 11.5 gallons per day and 16 gallons per day.
- Comes with model 8043 LCRP Canister
- Faster start-up and 35% more electrode surface area than model 800 with 120v application

Table IAQ-4-A – Steam Humidifier Models

Part Number	Part Description	Dimensions - W"xD"xH"	Weight (lbs)
EHUMD800ASM00C	Steam Humidifier w/ Manual Control	10.125 x 7.125 x 20.875	23
EHUMD800BSMLCC	Steam Humidifier Low Conductivity w/ Manual Control	10.125 x 7.125 x 20.875	23

Table IAQ-4-B – Specifications: Humidifier with Humidistat

Conductivity	Grains/Gal	Hardness	Recommended Model installed at 208/240v
75-100	0-3	Naturally Soft	Model 800LC
100-300	3-9	Naturally Soft	Model 800LC
300-500	9-15	Slightly Hard	Model 800
500-650	15-20	Moderately Hard	Model 800
650-850	20-25	Hard	Model 800
850-1250	25-36	Very Hard	Model 800
above 1250	above 36	Extremely Hard	Installation Not Recommended

Table IAQ-4-C – Accessories

Model Number	Description
8043RP	Canister, Rplc, 6-Pk, Serv First
8043LCRP	Replacement Steam Canister-Low Conductivity Model
5625RP	Humidistat, Manual, Serv First
5628RP	Drain Trap Assy, Serv First
5629RP	Air Flow Switch, Serv First
5630RP	High Humidity Switch, Serv First
5632RP	Condensate Pump Kit, Serv First
56TR	Convertible Automatic Humidifier Control, Trane Brand

1. What model is recommended for 120VAC installations?
 - a. The Model 800LC and 80LC canister are recommended regardless of water conditions.

** Registered Limited Warranty terms are available when you register within 60 days of installation. You can register online at Trane.com or by phone at 855-260-2975, otherwise Trane's Base Limited Warranty terms will apply. Base Limited Warranty information on specific products can be found on ComfortSite.com.

For complete equipment / combination selections, installation instructions and warranty information, please refer to Product Data/Ratings and/or Installers Guides and Limited Warranty Handbooks.



It's Hard To Stop A Trane.®

Humidifiers Fan Powered and Bypass



Fan Powered Humidifier



Bypass Humidifier

Fan Powered Humidifier

- Flow Through Fan Powered Humidifier
- High Performance Humidifier Delivers up to 18 Gallons per Day
- Automatic Humidifier Control with O.D. Sensor for up to 50% more Humidity
- Front Cover Access for easy replacement of humidifier pad
- Aluminum Humidifier Pad Treated with Ceramic Coating for Enhanced Pad Performance
- Reliable Brass Solenoid Valve w/

- Stainless Steel Valve Seat
- UV Resistant Cabinet and Scale Control Insert
- Saddle Valve
- Polyslate Gray Housing matches Furnace Cabinet Color
- 120V Power Line Cord
- 110V Primary/24VA Transformer

Bypass Humidifier

- EHUMD300A Bypass delivers up to 17 Gallons per day
- EHUMD200A delivers up to 12 Gallons per day
- EHUMD300A Automatic Humidifier Control and O.D. Sensor for up to 50% more Humidity
- EHUMD200A Manual Humidifier Control
- UV Resistant Cabinet and Scale Control Insert
- Front Cover Access for easy replacement of humidifier pad
- Aluminum Humidifier Pad Treated with Ceramic Coating for Enhanced Pad Performance

- Reliable Brass Solenoid Valve w/Stainless Steel Valve Seat
- Field Convertible Duct Connection, Left or Right Side
- Built in Summer / Winter Damper
- Saddle Valve
- Polyslate Gray Housing matches Furnace Cabinet Color
- 110V Primary / 24V Secondary 10VA Transformer

Table IAQ-5-A – Specifications: Humidifier with Humidistat

Model Number	Description	Used With	Shipping Weight
EHUMD500APA00D ^{①④}	Fan Powered Humidifier	All Furnace Models	20
EHUMD300ABA00C ^②	Large Bypass Humidifier	All Furnace Models	15
EHUMD200ABM00C ^③	Small Bypass Humidifier	All Furnace Models	14

- ① Includes Automatic Humidifier Control (Duct Mount Only).
 ② Includes Automatic Humidifier Control (Duct Mount Only) and 120/24V transformer.
 ③ Includes Manual Humidifier Control and 120/24V transformer.
 ④ Not applicable for horizontal installations.

Table IAQ-5-B – Accessories

Model Number	Description	Used With
BAYPAD02A1310A	Large Humidifier Pad 13"x10"	EHUMD500,300A
BAYPAD01A1010A	Small Humidifier Pad 9-7/8"x9-5/8"	EHUMD200A
ECONTH01AAUTOA	Automatic Humidifier Control	EHUMD200A
BAYRLY10ASENSA	Current Sensing Relay	All
BAYPLT01AMHCOA	Adapter Plate (Duct Mount)	Manual Humidifier Control
5803 Trane Badge	Trane Badge Bag (10 ea.)	EHUMD200, EHUMD300
5805 Trane Badge	Trane Badge Bag (10 ea.)	EHUMD500
BAYKIT01ASMBPA	Small bypass humidifier maintenance kit	EHUMD200A
BAYKIT01ALGBPA	Large bypass humidifier maintenance kit	EHUMD300A
BAYKIT01ALGFPA	Large fan powered humidifier maintenance kit	EHUMD500

For complete equipment / combination selections, installation instructions and warranty information, please refer to Product Data/Ratings and/or Installers Guides and Limited Warranty Handbooks.



It's Hard To Stop A Trane.®

Whole Home Dehumidifiers with Optional Ventilation



- Full line of horizontal dehumidifiers from 70 ppd to 120 ppd of moisture removal
- Exclusive XT coil technology means higher efficiency humidity removal rates than standard units
- All units come with optional ventilation capability to meet ASHRAE 62.2 Ventilation requirements
- Units can be ducted to and wired to operate with HVAC system or can used independently of HVAC system with internal blower and wired control
- Units come standard with MERV 13 filter for superior indoor air quality
- 5 Year Unit Replacement Warranty for Refrigeration Circuit Failures (Registered Warranty)*
- Engineered for low temperature operation providing comfort year round
- Optional digital controller for outdoor air ventilation and humidity control
- Designed for quiet operation

Table IAQ-6-A – Specifications: Trane® Whole Home Dehumidifiers with Optional Ventilation

Model Number	Description	Dimensions- W" x H" x L"	Weight (lbs.)
EDHUM70HAH1MNBA	Whole home 70 pint ventilating dehumidifier, 1,800 sq. ft. capacity	12 x 12 x 28	55
EDHUM098AH1MNBA	Whole home 98 pint ventilating dehumidifier, 2,300 sq. ft. capacity	14.5 x 19.5 x 32.375	81
EDHUM120AH1MNAA	Whole home 120 pint ventilating dehumidifier, 3,000 sq. ft. capacity	14.4 x 21.0 x 32.2	91

Table IAQ-6-B – Accessories

Model Number	Description	Dimensions- W" x H" x L"	Weight (lbs.)
4037724	Filter (qty 1), 9" x 11" x 1" MERV 13 (70)	14 x 10 x 8	1 lb.
4037736	Filter (qty 12) for 9" x 11" x 1" MERV 13 (70)	12 x 12 x 12	3 lb.
4037722	Filter (qty 1) 14" x 17.5" x 1.75" MERV 13 (98, 120)	20 x 20 x 7	3 lb.
4037732	Filter (qty 12) 14" x 17.5" x 1.75" MERV 13 (98, 120)	22 x 19 x 15	13 lb.
4036695	Hang kit (70, 98, 120)	24 x 7 x 7	7 lb.
4023672	6" motorized damper	10 x 10 x 10	3 lb.
4023647	8" gravity damper (70)	13 x 13 x 13	5 lb.
4024375	10" gravity damper (98, 120)	13 x 13 x 13	5 lb.
4028539	D30 control	9 x 6 x 2	1 lb.
4028407	D30 control with remote	9 x 6 x 4	1 lb.

Indoor Air Quality

* Registered Limited Warranty terms are available when you register within 60 days of installation. You can register online at Trane.com or by phone at 855-260-2975, otherwise Trane's Base Limited Warranty terms will apply. Base Limited Warranty information on specific products can be found on ComfortSite.com.

For complete equipment / combination selections, installation instructions and warranty information, please refer to Product Data/Ratings and/or Installers Guides and Limited Warranty Handbooks.



It's Hard To Stop A Trane.®

Inline Ventilator



- Full ECM motor, adjustable airflow from 30 to 130 cfm
- Programmable to prevent temperature and humidity extremes
- Includes MERV 8 filter for improved indoor air quality
- Quiet fan (.4 – 1.6 Sones) is virtually undetectable when operating
- “On - Off” switch on unit or controlled by 24V remote wired smart thermostat with ventilation software
- Compact design fits between framing members and comes with hanger brackets

Table IAQ-7-A – Specifications: Envirowise™ QF130V Inline Ventilator

Part Number	Part Description	Dimensions - W"xD"xH"	Weight (lbs)
EVENQF130V1NAAA	Inline Ventilator Fan with Relay	15.75 x 12.75 x 23	18

Table IAQ-7-B – Accessories

Model Number	Description	Dimensions - W"xD"xH"	Weight (lbs)
E1650024	Heater Model EQH400	14.5 x 14 x 10.25	8.25
E1650025	Heater Model EQH900	14.5 x 14 x 10.25	8.25
E1650026	6" Motorized Damper	6.3 x 9.45 x 10.63	4.5
E1955001	6" Screened Wall Cap	9 x 9 x 17	3
E1650123	2 Pack 10x10x2 Filter	10 x 10 x 4	0.95



It's Hard To Stop A Trane.®



Energy Recovery Ventilator (ERV)

ERV technology for all seasons and climates

- Static plate energy transfer core for efficient transfer of heat and moisture
- Passive defrost - condensate drain not required
- Pressure ports are accessible through front panel without door removal
- 2 "Guillotine" type dampers are included to balance for correct airflow
- Multi position mounting
- Percent Timer (PT) control included with ERV for simple, automatic operation
- Optional Push Button (PB) control connects to PT control
- Pull-down door latches for quick service access
- Heavy gauge, powder painted steel cabinet
- Permanently lubricated motor bearings (ball bearings)
- 6" and 8" double collar duct connections for EERVR100 and 200
- 8" round compatible duct connection for EERVR300
- Closed cell foam gasketing for insulation integrity
- 1" duct board insulation with cleanable foil face
- May be installed in conditioned and unconditioned spaces
- Cabinet / Door color: Trane Polyslate Gray
- 5 year Parts Warranty.
- Registered Limited Warranty 10-years*
- MERV 8 replaceable filter included

Table IAQ-8-A – Specifications: ERV

Model Number	Nominal Airflow (CFM)	Power Supply	Uncrated Dimensions (In.) H x W x D	Shipping Weight
EERVR100A1P00B ^①	130	120/1/60	20 ¹ / ₈ x 28 ³ / ₄ x 13	65
EERVR200A1P00B ^①	200	120/1/60	20 ¹ / ₈ x 28 ³ / ₄ x 23 ⁷ / ₈	85
EERVR300A1P00B ^①	300	120/1/60	20 ¹ / ₈ x 28 ³ / ₄ x 23 ⁷ / ₈	95

^① Percent Timer Control included with the ERV.

Table IAQ-8-B – Specifications: ERV

Model Number	Sensible Recovery Effectiveness(32°F)	Latent Recovery (32°F)	Total Recovery (95°F)
EERVR100A1P00B	72% @ 124 cfm	55% @ 124 cfm	46% @ 126 cfm
EERVR200A1P00B	78% @ 181 cfm	62% @ 181 cfm	52% @ 180 cfm
EERVR300A1P00B	70% @ 295 cfm	51% @ 295 cfm	43% @ 295 cfm

Table IAQ-8-C – Optional Accessories

Model Number	Description	Used With	Shipping Weight
ECONTV10APBC0A	Point of Use Push Button Control	ERV models 100, 200, 300	1
FLR08618	Filters - 2 per pack	ERV models 100	1
FLR08619	Filters - 2 per pack	ERV models 200, 300	1
BAYWHT10AVENTA ^②	6 inch White Vinyl Ventilation Hood	ERV models 100, 200	1
BAYBRN10AVENTA ^②	6 inch Brown Vinyl Ventilation Hood	ERV models 100, 200	1
BAYGLV10AVENTA ^②	8 inch Galvanized Ventilation Hood	ERV models 300	2

^② Qty 1.

* Registered Limited Warranty terms are available when you register within 60 days of installation. You can register online at Trane.com or by phone at 855-260-2975, otherwise Trane's Base Limited Warranty terms will apply. Base Limited Warranty information on specific products can be found on ComfortSite.com.

For complete equipment / combination selections, installation instructions and warranty information, please refer to Product Data/Ratings and/or Installers Guides and Limited Warranty Handbooks.



It's Hard To Stop A Trane.®

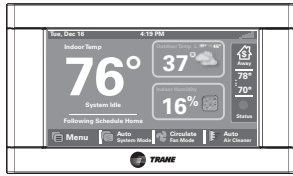

**XL 824
TCONT824AS52DB**



Conventional 24 Volt Smart Thermostat

TCONT824AS52DB

- Energy Star® certified
- Z-Wave Plus Bridge Inside
- Trane Diagnostics ①
- WiFi or Ethernet connection
- Control from a smartphone, tablet, or computer ①②
- 4.3" Color touchscreen
- 7 Day programmable with up to four schedules per day
- Five day weather forecast, weather radar, and weather alerts ①
- Indoor relative humidity display
- Enhanced dehumidification (cooling)
- 2 Auxiliary dry contacts control 2 of the following: Whole house humidifier, dehumidifier, or ventilation system
- Integrated Dehumidification Solution (IDS) capable
- Test modes and alert diagnostics
- Screen access restrictions
- Over-the-air software upgrade ①
- Local software upgrade option
- Color: Designer Silver
- Retail Package Sleeve
- Limited Warranty: 5 yr. base/10 yr.

Application:

- Conventional gas/electric, heat pump, and dual fuel systems
- Conventional boiler systems (forced air only)
- Conventional HVAC systems:
 - 2 Heat / 2 cool
 - Heat Pump systems: Up to 5 stages heat / 2 stages cool (2 compressor heat - 3 auxiliary heat / 2 cooling)
 - Heat Pump switchover valve: selectable "with cool or with heat"
- Remote wired indoor temperature sensor (optional) ZZSENSAL0400AA
- Remote wireless indoor temperature and humidity sensor (optional): ZSENS930AW00MA
- Remote wired outdoor temperature sensor (optional) BAYSEN01ATEMPA
- PWM Circuit (BK terminal): controls indoor unit variable speed blower
- Wall cover plate BAYCOVR800A

Dimensions:

- Product: 5.43"w x 3.39"h x 1.30"d
- Display: 4.15"w x 2.65"h

① Requires internet service and Trane® Home smart home system registration.

② Trane® Home remote climate access is included with the purchase for up to 8 Connected Controls per home. Adding accessories or additional controls to your Trane® Home system may require a monthly subscription.

For complete equipment / combination selections, installation instructions and warranty information, please refer to Product Data/Ratings and/or Installers Guides and Limited Warranty Handbooks.



It's Hard To Stop A Trane.®

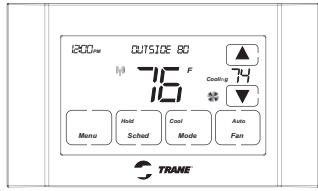

**XR 724
TCONT724AS42DA**

Conventional 24 Volt Smart Thermostat

TCONT724AS42DA

- Mobile app compatible (download Trane Home) ①②
- Trane Diagnostics ①
- Control from a smartphone, tablet, or computer ①②
- 4.3" diagonal black and white touchscreen
- 7 Day programmable with up to 4 schedules per day
- Humidity sensor and RH display
- Remote temperature sensor connections (1 indoor/1 outdoor)
- Auxiliary & compressor heat lockouts
- Auxiliary dry contact
- Enhanced dehumidification (cooling)
- PWM Circuit (BK terminal): control indoor unit variable speed blowers
- Energy Savings Mode (ESM)
- Screen lock and guest lock
- Service test modes
- Upgradable software
- Color: Designer Silver
- Retail Package Sleeve
- Limited Warranty: 1 yr. base/5 yr.

Application:

- Up to 4 Stages Heat/2 Stages Cool
- Conventional gas/electric, heat pump, and dual fuel systems
- Conventional boiler systems (baseboard & radiators)
- Remote wired indoor temperature sensor (optional): ZZSENSAL0400AA
- Remote wired outdoor temperature sensor (optional): BAYSEN01ATEMPA
- Wall cover plate BAYCOVR800A
- Z-Wave Bridge is required for control of Z-Wave devices, such as lighting, door locks, etc., and remote climate access. The Z-Wave Bridge is purchased separately. ①②

Dimensions:

- Product: 5.9"w x 3.47"h x .95"d
- Display: 3.8"w x 2.3"h

① Requires internet service and Trane® Home smart home system registration.
 ② Trane® Home remote climate access is included with the purchase for up to 8 Connected Controls per home. Adding accessories or additional controls to your Trane® Home system may require a monthly subscription. Remote access is via most web-enabled smartphones, tablets and computers.

Trane® Link Communicating System Controller and Smart Thermostat



SC360
System controller



UX360
Smart thermostat

TLINK360A2VVUA

(kit includes System Controller and Smart Thermostat)

- Mobile app compatible with built-in Z-Wave bridge (download Trane Home mobile app)
- Trane Diagnostics ①
- Trane Diagnostics mobile app compatibility allows for easy technician commissioning and servicing
- WiFi connection
- Control from a smartphone, tablet, or computer ①②
- 7" diagonal color touchscreen
- 1-Touch Presets - Home, Away, Sleep
- 7 Day programmable with up to four schedules per day
- Smart Continuous Fan
- Adjustable Continuous Airflow (35-100%)
- Five day weather forecast ①
- Indoor relative humidity display
- Test modes and alert diagnostics
- Over-the-air Software Upgrade ①
- Color: Designer White
- Limited Warranty: 5 yr. base/10 yr.

Application:

- TruComfort™ Variable Speed
- Remote wired temperature sensor available through the hub
- Remote wireless indoor temperature and humidity sensor (optional): ZSENS930AW00MA

① Requires internet service and Trane® Home smart home system registration.
② Trane® Home remote climate access is included with the purchase for up to 8 Connected Controls per home. Adding accessories or additional controls to your Trane® Home system may require a monthly subscription. Remote access is via most web-enabled smartphones, tablets and computers.



It's Hard To Stop A Trane.®

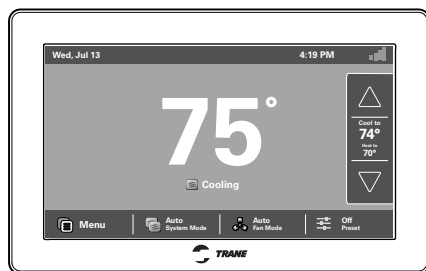

XL 1050
TZON1050AC52ZA

ComfortLink™ II Communicating Smart Thermostat

TZON1050AC52ZA

- Z-Wave Plus Bridge Inside
- Trane Diagnostics ①
- WiFi or Ethernet connection
- Control from a smartphone, tablet, or computer ①②
- 7" diagonal color touchscreen
- 1-Touch Presets - Home, Away, Sleep
- 7 Day programmable with up to four schedules per day
- Customizable Home Screen
- Runtime History
- Allergy and Quick Clean Air Cycles
- Smart Continuous Fan
- Adjustable Continuous Airflow (35-100%)
- Screen access restrictions
- Dealer Contact Widget
- Service, Filter, Humidifier, UV Light, Air Cleaner Reminders
- Five day weather forecast, weather radar, and weather alerts ①
- Integrated Dehumidification Solution (IDS) capable
- Indoor relative humidity display
- Test modes and alert diagnostics
- Over-the-air Software Upgrade ①
- Local Software Upgrade option
- Color: Designer Silver
- Retail Package Sleeve
- Limited Warranty: 5 yr. base/10 yr.

Application:

- TruComfort™ Variable Speed
- ComfortLink™ II Two Stage Systems
- ComfortLink™ II Zoning Systems
- TruComfort™ Variable speed outdoor cooling or heat pump unit combined with S-Series non-communicating variable speed furnace and "C" model Relay Panel
- Relay panel (BAY24VRP52DC) is required when applied with conventional systems (Gas Electric, Heat Pump, Dual Fuel, Boilers - forced air only)
- Relay Panel Supports:
 - Up to 5 stages heat, 2 stages cool
 - Connections for Remote indoor and outdoor temperature sensors
 - 3 Dry Auxiliary Contacts to control whole house humidifier, dehumidifier, or ventilation system
- Remote wired indoor temperature sensor (optional) ZZSENSAL0400AA
- Remote wireless indoor temperature and humidity sensor (optional): ZSENS930AW00MA
- Remote wired outdoor temperature sensor (optional) BAYSEN01ATEMPA

Dimensions:

- Product: 7.2"w x 4.5"h x 1.2"d
- Display: 6.1"w x 3.3"h

- ① Requires internet service and Trane® Home smart home system registration.
- ② Trane® Home remote climate access is included with the purchase for up to 8 Connected Controls per home. Adding accessories or additional controls to your Trane® Home system may require a monthly subscription. Remote access is via most web-enabled smartphones, tablets and computers.

For complete equipment / combination selections, installation instructions and warranty information, please refer to Product Data/Ratings and/or Installers Guides and Limited Warranty Handbooks.



It's Hard To Stop A Trane.®

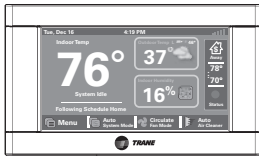

**XL 850
TCONT850AC52UB**

ComfortLink™ II Communicating Smart Thermostat

TCONT850AC52UB

- Z-Wave Plus Bridge
- WiFi or Ethernet connection
- Control from a smartphone, tablet, or computer ①②
- 4.3" diagonal color touchscreen
- Compatible with ComfortLink™ II communicating systems (variable speed and two stage)
- Compatible with conventional 24 volt HVAC, heating, heat pump, and dual fuel systems when used with accessory relay panel model BAY24VRPAC52DC
- 7 Day programmable with up to four schedules per day
- Five day weather forecast, radar, and alerts ①
- Integrated Dehumidification Solution (IDS) capable
- Indoor relative humidity display
- Test modes and alert diagnostics
- Trane Diagnostics ①
- Over-the-air software upgrades ①
- Local software upgrade option
- Color: Designer Silver
- Wall cover plate BAYCOVR800A
- Retail Package Sleeve
- Limited Warranty: 5 yr. base/10 yr.

Application:

- ComfortLink™ II communicating systems (variable speed and two stage)
- Variable speed outdoor cooling combined with S-Series non-communicating variable speed furnace and "C" model Relay Panel
- Conventional gas/electric, heat pump, dual fuel systems, or boiler systems (forced air only) with use of relay panel model BAY24VRPAC52DB. Relay panel controls up to 5 stages heat, 2 stages cool, remote indoor and outdoor connections, humidifier, dehumidifier, and ventilation system.
- Remote wired indoor temperature sensor (optional) ZZSENSAL0400AA
- Remote wireless indoor temperature and humidity sensor (optional): ZSENS930AW00MA
- Remote wired outdoor temperature sensor (optional) BAYSEN01ATEMPA

Dimensions:

- Product: 5.43"w x 3.39"h x 1.30"d
- Display: 4.15"w x 2.65"h

Wall Cover Plate

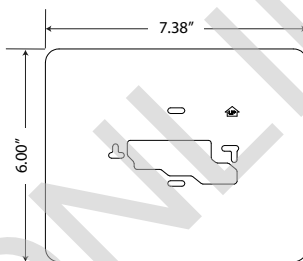

BAYCOVR800A

BAYCOVR800A

Application:

- Use with
TCONT624AS42DA,
TCONT724AS42DA,
TCONT824AS52DA,
TCONT850AC52UA

Dimensions:

- 7.38" w x 6.00" h
- Finish: Silver

For complete equipment / combination selections, installation instructions and warranty information, please refer to Product Data/Ratings and/or Installers Guides and Limited Warranty Handbooks.

CCZO-5

Effective 1/1/23
22-8301-36

① Requires internet service and connection to Trane® Home smart home system.
② Trane® Home remote climate access is included with the purchase of up to 8 Connected Controls per home. Adding accessories to your Trane® Home system may require a monthly subscription for remote access via most web-enabled smartphones, tablets and computers.



It's Hard To Stop A Trane.®

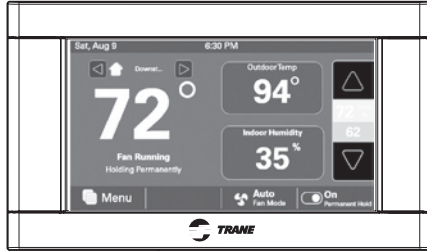

**XL 1040
TZON1040AC52ZA**

Zoning Communicating Sensor with Display

TZON1040AC52ZA

- For use with ComfortLink™II Zoning Systems
- 3-Wire Communicating Zone Sensor
- 4.3" diagonal color touchscreen
- Zone Mode - Auto only
- Fan Mode - Auto/On
- Displays Zone Temperature & Relative Humidity.
- Average multiple zone temp sensors
- Displays Outdoor Temperature (Trane Home registration or wired ODT required)
- Clean Screen Function
- 3 Levels of Restricted Access
- Fahrenheit or Celsius
- Adjust zone Setpoint at 1040, 1050, and Trane Home Smart Home
- Schedule 1040, 1050, and Trane Home Smart Home
- Zone Schedule Override
 - Permanent Hold
- Enter zone name at 1040 and 1050
- Over the Air upgrades via the 1050
- Screen color with backlit options
- Screensaver options

Dimensions:

- Product: 5.43"w x 3.39"h x 1.30"d
- Display: 4.15"w x 2.65"h

Storage Temperature:

- -40°F to 170°F, 0% - 95% RH

Operating Temperature:

- 32°F - 120°F, 5% - 90% RH non-condensing



It's Hard To Stop A Trane.®

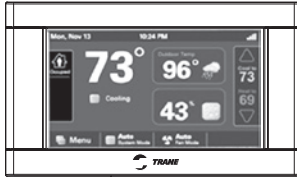

Trane® Pivot™
TCONT830AS52DA
(Commercial Applications Only)

Trane® Pivot™ Commercial Thermostat

The Pivot thermostat, for use in commercial applications only, is a color touch-screen, programmable control that is equipped with remote access. The Pivot thermostat is specifically designed for single zone constant volume commercial buildings. It has a very simple interface for occupants to adjust their thermostat. Cooling and heating control is made easier when connected to the Pivot Mobile App. Connecting to the Pivot Mobile App provides the capability to take full advantage of all benefits of the Pivot thermostat.

TCONT830AS52DA

- Service Support with diagnostics ①
- Designed for commercial business
- Customized display widgets
- 3 levels of access restrictions
- Manage user by enable/disable per mobile device
- 7 day programmable up to 6 events per day (3 occupied/3 unoccupied)
- Single button override for after hour use
- Configurable timed override logic
- Grouping for mass overrides
- Trane Pivot connected to the mobile app and diagnostics
- Efficient remote management
- Schedule can be sent to multiple Pivot thermostats
- Grouping for mass overrides
- Touchscreen Display: 4.15" x 2.65" (4.3" diagonal)
- Limited Warranty: 5-Year Material

Application:

- Conventional HVAC system compatibility with up to 3 heat/2 cool dual fuel (gas/electric)
- Heat pump systems:
- Up to 5 stages heat/2 stages cool (2 compressor plus 3 auxiliary)
- Heat pump switchover valve
- Selectable with cool or heat
- Wired remote indoor sensor (ZZSENSAL0400AA)
- Wired remote outdoor sensor (BAYSEN01ATEMPA)
- Two auxiliary outputs (dry contacts) for dehumidification, humidification, or ventilation
- System Modes: Auto, Heating, Cooling, Off
- Fan Modes: Auto, On
- Auxiliary Heat Lockout: 32°F to 70°F
- Compressor Heat Lockout: 55°F to 70°F
- Cooling Setpoint Range: 60°F to 99°F (1°F resolution)
- Heating Setpoint Range: 55°F to 99°F (1°F resolution)
- Indoor Temperature Display Range: 140°F to 122°F
- Outdoor Temperature Display Range: -40°F to 140°F
- Indoor Humidity Range: 0% to 100% (1% resolution)
- Minimum Cycle Off Time Display: Compressor; 5 minutes, Indoor Heat; 1 minutes
- Storage/Operating Temperature: -0°F to 175°F, 5% to 95% RH non-condensing
- 24 Volts AC

Dimensions:

- Product: 5.43"w x 3.39"h x 1.30"d
- Display: 4.15"w x 2.65"h

For complete equipment / combination selections, installation instructions and warranty information, please refer to Product Data/Ratings and/or Installers Guides and Limited Warranty Handbooks.

CCZO-7

① Requires internet service and connection to the Trane Pivot mobile app.

Effective 1/1/23
22-8301-36



It's Hard To Stop A Trane.®

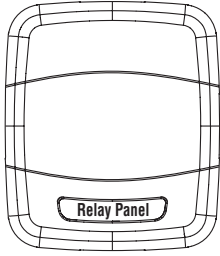

BAY24VRPAC52DC

Conventional 24 Volt HVAC System Interface Relay Panel for ComfortLink™ Controls

BAY24VRPAC52DC – With AUX

Contact Control

- 5 Heat (Gas, Oil, Electric)/2 Cool/Heat Pump/Dual Fuel
- Optional remote indoor temperature connection point
- Optional remote outdoor temperature connection point
- LED stage indicators
- Removable low voltage terminal blocks for easy service and replacement
- **AUX Contacts**
 - Whole-house Dehumidifier Control
 - Ventilation Control
 - Humidifier Control
- Relay Panel provides support for the following equipment combination:
 - Variable Speed heat pump and cooling units
 - S-Series Non-communicating Variable Speed Furnace
 - TCONT850AC52UA or TZON1050AC52ZA

Dimensions:

- 8.0" width x 9.3" height x 1.9" depth

Storage Temperature:

- -40° to 175°F, 5% - 95% RH non-condensing

Operating Temperature:

- -40° to 150°F, 5% - 95% RH non-condensing

Trane[®] Link System Component Overview

Trane[®] LINK System

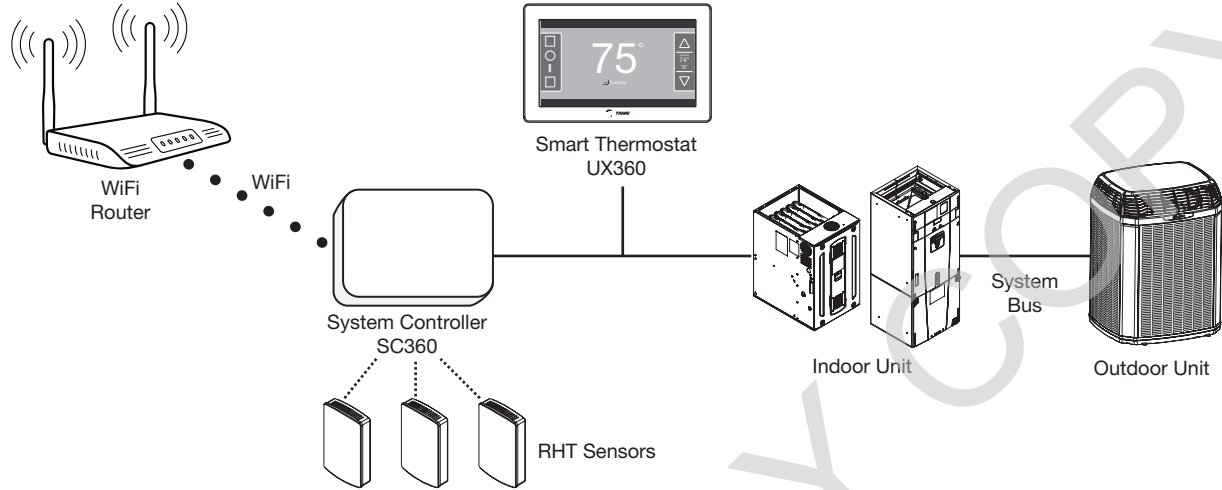

Link Zoning coming in Q2 of 2023.

ComfortLink™ II XL 1050 Control Component Overview

Communicating System

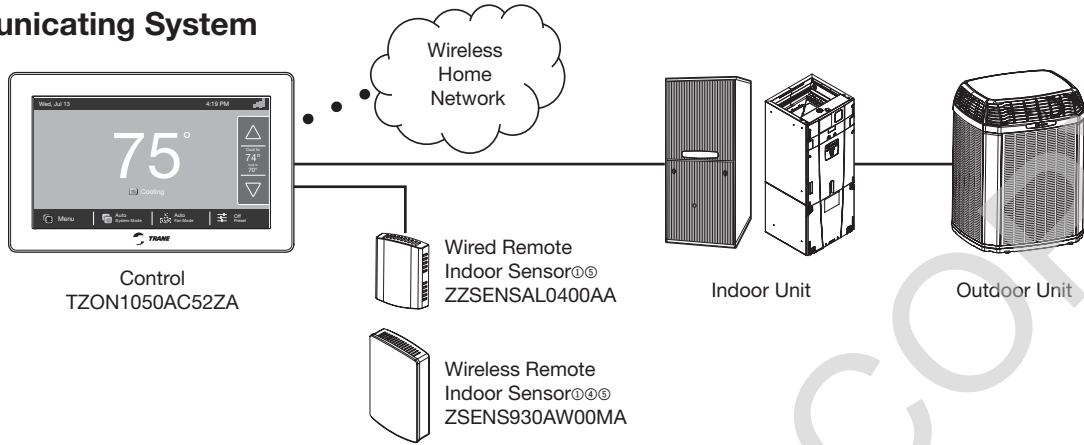

24V System

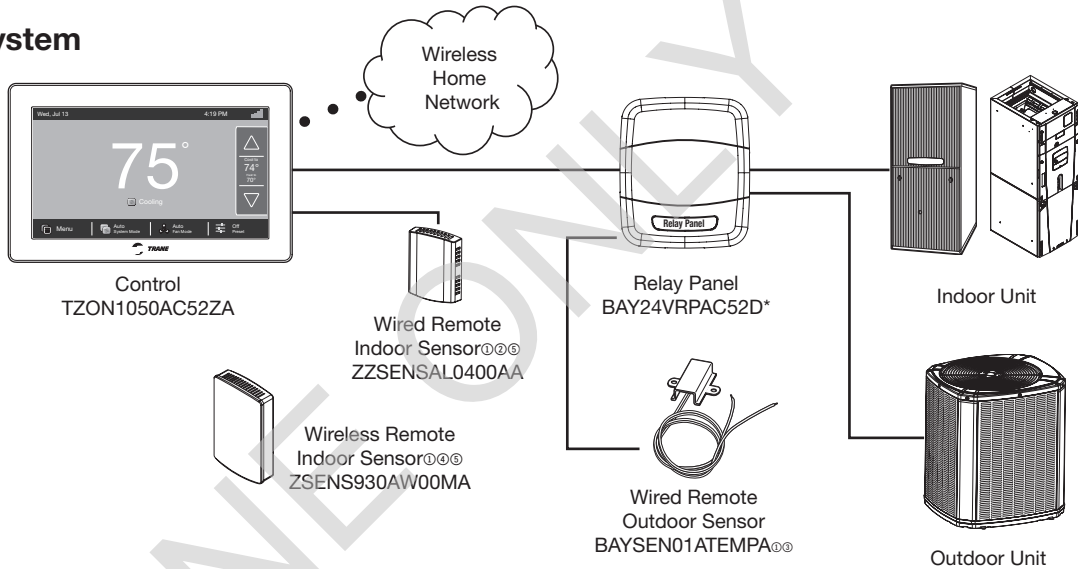

- ① Optional Accessory
- ② Can alternatively be connected to the Relay Panel
- ③ Can alternatively be connected to the 1050 Control
- ④ Z-wave sensor may be added to 1050 built in bridge
- ⑤ Use one wireless or wired sensor per zone

For complete equipment / combination selections, installation instructions and warranty information, please refer to Product Data/Ratings and/or Installers Guides and Limited Warranty Handbooks.

ComfortLink™ II Zoning Assembly

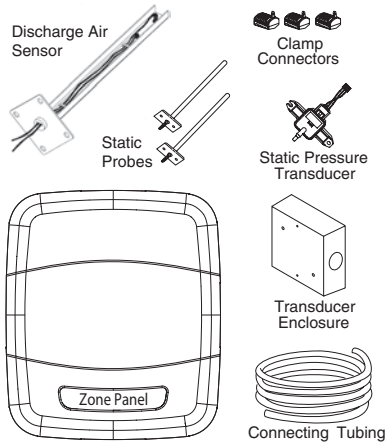

ZZONEPNLAC52ZB

ZZONEPNLAC52ZB

Trane Variable Speed Indoor Unit (Air Handler/Gas Furnace) required.

Includes:

- Four Zone Communicating Zone Panel with discharge air sensor, static pressure transducer and housing, supply, return air static probes and connecting tubing, & three wiring blocks
- Automatically sets maximum CFM per zone
- Compatible with 24 volt systems with the addition of 24 volt relay panel
- Controls 24 volt power open, power close modulating dampers

- Auto detects installed dampers
- Supports 2-wire (ZZSENSAL0400AA) and 3-wire (TZONE940) zone sensors.
- Adjustable damper motor travel times of 15 to 60 seconds
- Requires field supplied 24 volt power supply
- Up to four 1.5 VA dampers can be wired in parallel to each zone
- Backlit LCD display for easy setup and service
- Removable low voltage terminal blocks for easy service and replacement

ComfortLink™ II Zone Expander Panel (Required with more than 4 zones)

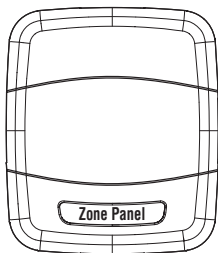

ZZONEEXPAC52ZB

ZZONEEXPAC52ZA*

- Expands the maximum number of zones per system to eight
- Controls 24 volt power open, power close modulating dampers
- Auto detects installed dampers
- Supports 2-wire (ZZSENSAL0400AA) and 3-wire (TZONE940) zone sensors.
- Adjustable damper motor travel times of 15 to 60 seconds
- Requires field supplied 24 volt power supply

Dimensions:

- 8.0" width x 9.3" height x 1.9" depth

Storage Temperature:

- -40° to 175°F, 5% to 95% RH non-condensing

Operating Temperature:

- -40° to 150°F, 5% to 95% RH non-condensing

*This is the same Zone Panel that ships as part of the Zoning Assembly

ComfortLink™ II Zoning Component Overview

Zoned Communicating System

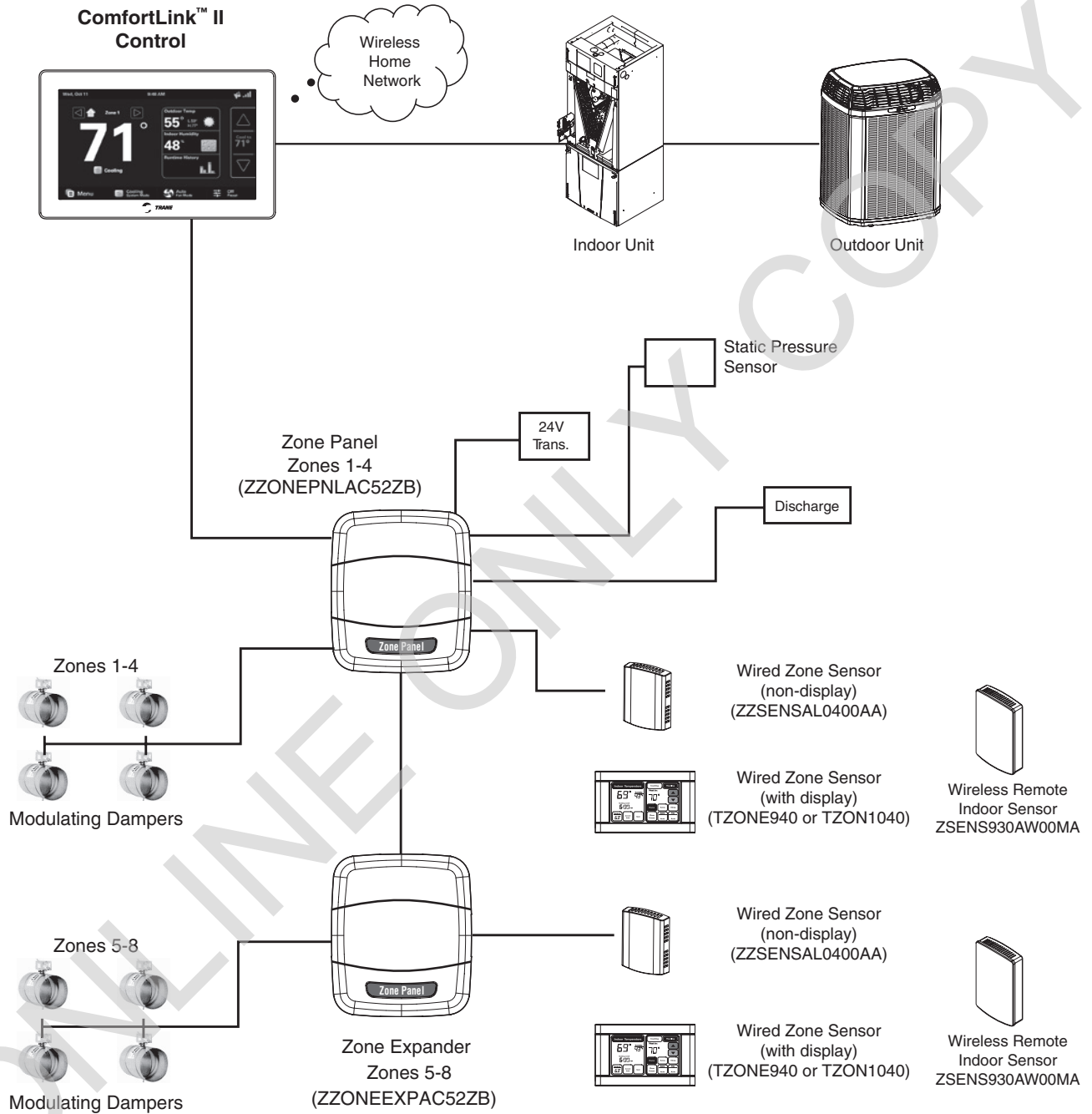

- Note 1. Each Zone Panel or Zone Expander supports up to four zones.
 - Note 2. One 940 or 1040 may be installed per zone.
 - Note 3. Up to four 0400 wired sensors or 930 wireless sensors may be installed per zone.
 - Note 4. If a 940 or 1050 is used, then up to three 0400 wired sensors or 930 wireless sensors may be installed per zone.
 - Note 5. To apply up to four sensors per zone, software version 5,4 or higher is required.]
- Example: One 940, two 930, and one 0400 may be installed per zone.

Smart Thermostats/Zone Sensors

For complete equipment / combination selections, installation instructions and warranty information, please refer to Product Data/Ratings and/or Installers Guides and Limited Warranty Handbooks.



It's Hard To Stop A Trane.®

ComfortLink™ II Zoning Component Overview (Cont.)

Zoned 24V System

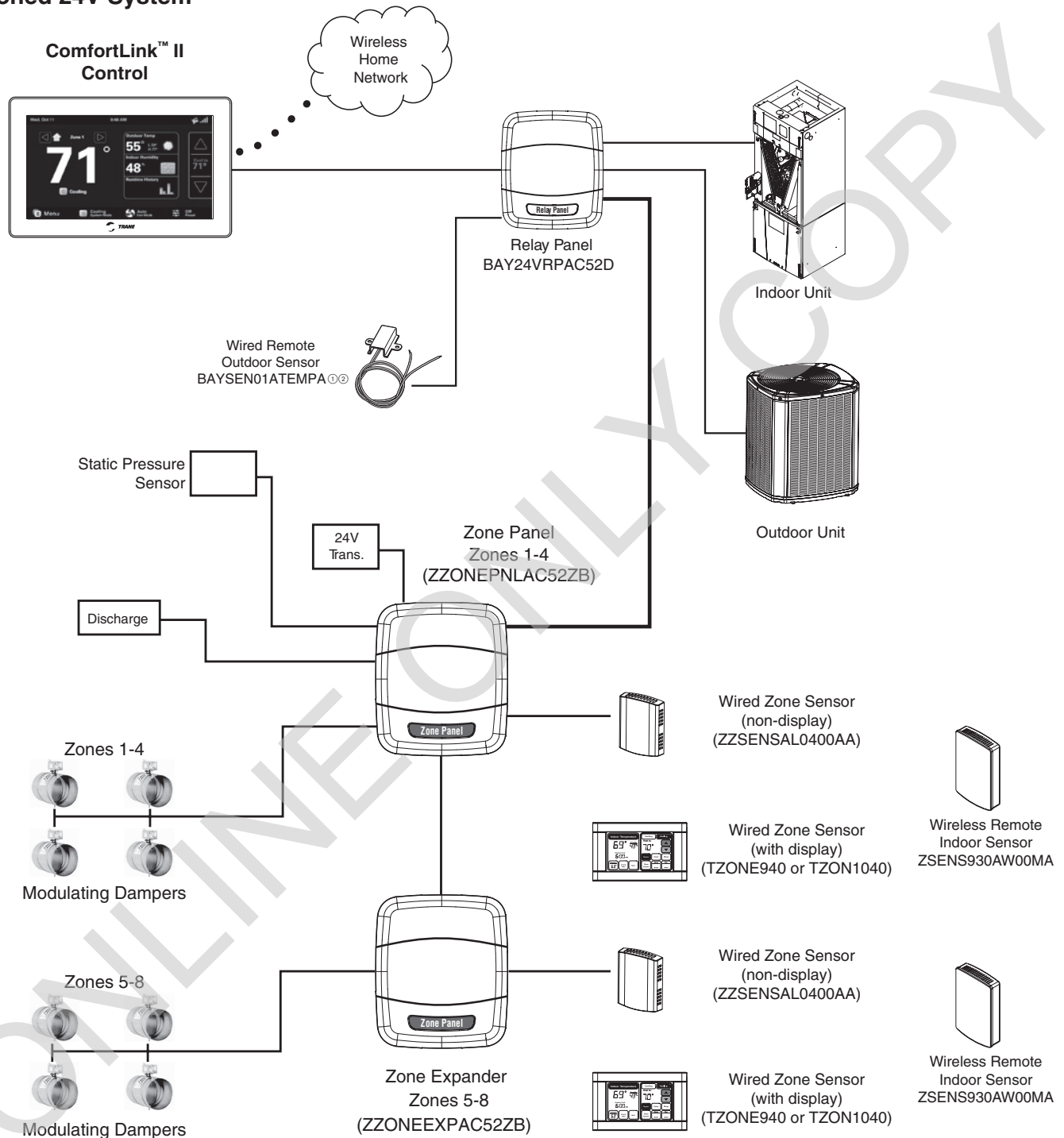

- Note 1. Each Zone Panel or Zone Expander supports up to four zones.
 - Note 2. One 940 or 1040 may be installed per zone.
 - Note 3. Up to four 0400 wired sensors or 930 wireless sensors may be installed per zone.
 - Note 4. If a 940 or 1050 is used, then up to three 0400 wired sensors or 930 wireless sensors may be installed per zone.
 - Note 5. To apply up to four sensors per zone, software version 5,4 or higher is required.]
- Example: One 940, two 930, and one 0400 may be installed per zone.

For complete equipment / combination selections, installation instructions and warranty information, please refer to Product Data/Ratings and/or Installers Guides and Limited Warranty Handbooks.



It's Hard To Stop A Trane.®

24 Volt Modulating Dampers

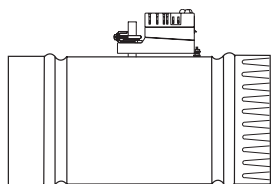

Round Dampers

Round Dampers

- 24 VAC Powered open/Powered closed
- Three wire connection - 18 gauge
- 1.5 VA damper actuator with 60 second travel time
- 18 in. lbs. of torque
- Manual gear release
- Screw terminal blocks
- Flexible shutoff seal provides 98% closure

Table CCZO-14-A – Specifications: Round Dampers

Model Number	Power Supply	Description	Fits Round Duct Size
ZDAMPRDMA0004A	24 VAC	Round	4"
ZDAMPRDMA0006A	24 VAC	Round	6"
ZDAMPRDMA0007A	24 VAC	Round	7"
ZDAMPRDMA0008A	24 VAC	Round	8"
ZDAMPRDMA0009A	24 VAC	Round	9"
ZDAMPRDMA0010A	24 VAC	Round	10"
ZDAMPRDMA0012A	24 VAC	Round	12"
ZDAMPRDMA0014A	24 VAC	Round	14"
ZDAMPRDMA0016A	24 VAC	Round	16"
ZDAMPRDMA0018A	24 VAC	Round	18"
ZDAMPRDMA0020A	24 VAC	Round	20"

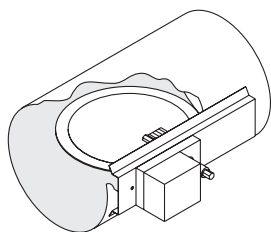

Retro-Fit Round Dampers

Retro-Fit Round Dampers

- 24 VAC Powered open/Powered closed
- Three wire connection - 18 gauge
- Slip-In-Design installs quickly
- 1.5 VA damper actuator with 60 second travel time
- 18 in. lbs. of torque
- Manual gear release
- Screw terminal blocks
- Flexible shutoff seal provides 98% closure

Table CCZO-14-B – Specifications: Retrofit Round Dampers

Model Number	Power Supply	Description	Fits Round Duct Size
ZDAMPRRMA0004A	24 VAC	Retrofit Round	4"
ZDAMPRRMA0005A	24 VAC	Retrofit Round	5"
ZDAMPRRMA0006A	24 VAC	Retrofit Round	6"
ZDAMPRRMA0007A	24 VAC	Retrofit Round	7"
ZDAMPRRMA0008A	24 VAC	Retrofit Round	8"
ZDAMPRRMA0009A	24 VAC	Retrofit Round	9"
ZDAMPRRMA0010A	24 VAC	Retrofit Round	10"

24 Volt Modulating Dampers - Side Mount

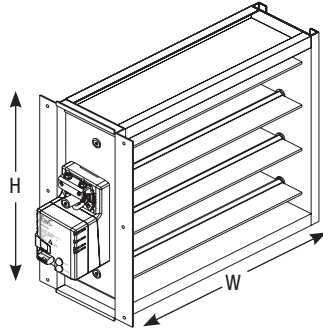

Rectangular Dampers with Side Mount Actuator

Rectangular Dampers with Side Mount Actuator

- 24 VAC Powered open/Powered closed
- Three wire connection - 18 gauge
- 1.5 VA damper actuator with 60 second travel time
- 18 in. lbs. of torque
- Manual gear release
- Screw terminal blocks
- 97% leak proof rating
- Sturdy aluminum blades and frame
- Motor is always located on the second dimension of the model number, i.e ZDAMP*MMA1012A will have the motor mounted on the 12" dimension

Table CCZO-15-A — Specifications: Rectangular Dampers with Side Mount Actuator

Model Number	Power Supply	Description	Uncrated Dimensions (in.)	
			W	H
ZDAMPSMMA0806A	24 VAC	Rectangular-Side Mount Actuator	8	6
ZDAMPSMMA0808A	24 VAC	Rectangular-Side Mount Actuator	8	8
ZDAMPSMMA1006A	24 VAC	Rectangular-Side Mount Actuator	10	6
ZDAMPSMMA1008A	24 VAC	Rectangular-Side Mount Actuator	10	8
ZDAMPSMMA1010A	24 VAC	Rectangular-Side Mount Actuator	10	10
ZDAMPSMMA1206A	24 VAC	Rectangular-Side Mount Actuator	12	6
ZDAMPSMMA1208A	24 VAC	Rectangular-Side Mount Actuator	12	8
ZDAMPSMMA1210A	24 VAC	Rectangular-Side Mount Actuator	12	10
ZDAMPSMMA1212A	24 VAC	Rectangular-Side Mount Actuator	12	12
ZDAMPSMMA1406A	24 VAC	Rectangular-Side Mount Actuator	14	6
ZDAMPSMMA1408A	24 VAC	Rectangular-Side Mount Actuator	14	8
ZDAMPSMMA1410A	24 VAC	Rectangular-Side Mount Actuator	14	10
ZDAMPSMMA1412A	24 VAC	Rectangular-Side Mount Actuator	14	12
ZDAMPSMMA1414A	24 VAC	Rectangular-Side Mount Actuator	14	14
ZDAMPSMMA1606A	24 VAC	Rectangular-Side Mount Actuator	16	6
ZDAMPSMMA1608A	24 VAC	Rectangular-Side Mount Actuator	16	8
ZDAMPSMMA1610A	24 VAC	Rectangular-Side Mount Actuator	16	10
ZDAMPSMMA1612A	24 VAC	Rectangular-Side Mount Actuator	16	12
ZDAMPSMMA1614A	24 VAC	Rectangular-Side Mount Actuator	16	14
ZDAMPSMMA1616A	24 VAC	Rectangular-Side Mount Actuator	16	16
ZDAMPSMMA1806A	24 VAC	Rectangular-Side Mount Actuator	18	6
ZDAMPSMMA1808A	24 VAC	Rectangular-Side Mount Actuator	18	8
ZDAMPSMMA1810A	24 VAC	Rectangular-Side Mount Actuator	18	10
ZDAMPSMMA1812A	24 VAC	Rectangular-Side Mount Actuator	18	12
ZDAMPSMMA1814A	24 VAC	Rectangular-Side Mount Actuator	18	14
ZDAMPSMMA1816A	24 VAC	Rectangular-Side Mount Actuator	18	16
ZDAMPSMMA1818A	24 VAC	Rectangular-Side Mount Actuator	18	18
ZDAMPSMMA2006A	24 VAC	Rectangular-Side Mount Actuator	20	6
ZDAMPSMMA2008A	24 VAC	Rectangular-Side Mount Actuator	20	8
ZDAMPSMMA2010A	24 VAC	Rectangular-Side Mount Actuator	20	10
ZDAMPSMMA2012A	24 VAC	Rectangular-Side Mount Actuator	20	12
ZDAMPSMMA2014A	24 VAC	Rectangular-Side Mount Actuator	20	14
ZDAMPSMMA2016A	24 VAC	Rectangular-Side Mount Actuator	20	16
ZDAMPSMMA2018A	24 VAC	Rectangular-Side Mount Actuator	20	18
ZDAMPSMMA2020A	24 VAC	Rectangular-Side Mount Actuator	20	20

24 Volt Modulating Dampers - Side Mount

Table CCZO-16-A — Specifications: Rectangular Dampers with Side Mount Actuator (continued)

Model Number	Power Supply	Description	Uncrated Dimensions (in.)	
			W	H
ZDAMPSMMA2206A	24 VAC	Rectangular-Side Mount Actuator	22	6
ZDAMPSMMA2208A	24 VAC	Rectangular-Side Mount Actuator	22	8
ZDAMPSMMA2210A	24 VAC	Rectangular-Side Mount Actuator	22	10
ZDAMPSMMA2212A	24 VAC	Rectangular-Side Mount Actuator	22	12
ZDAMPSMMA2214A	24 VAC	Rectangular-Side Mount Actuator	22	14
ZDAMPSMMA2216A	24 VAC	Rectangular-Side Mount Actuator	22	16
ZDAMPSMMA2218A	24 VAC	Rectangular-Side Mount Actuator	22	18
ZDAMPSMMA2220A	24 VAC	Rectangular-Side Mount Actuator	22	20
ZDAMPSMMA2222A	24 VAC	Rectangular-Side Mount Actuator	22	22
ZDAMPSMMA2406A	24 VAC	Rectangular-Side Mount Actuator	24	6
ZDAMPSMMA2408A	24 VAC	Rectangular-Side Mount Actuator	24	8
ZDAMPSMMA2410A	24 VAC	Rectangular-Side Mount Actuator	24	10
ZDAMPSMMA2412A	24 VAC	Rectangular-Side Mount Actuator	24	12
ZDAMPSMMA2414A	24 VAC	Rectangular-Side Mount Actuator	24	14
ZDAMPSMMA2416A	24 VAC	Rectangular-Side Mount Actuator	24	16
ZDAMPSMMA2418A	24 VAC	Rectangular-Side Mount Actuator	24	18
ZDAMPSMMA2420A	24 VAC	Rectangular-Side Mount Actuator	24	20
ZDAMPSMMA2422A	24 VAC	Rectangular-Side Mount Actuator	24	22
ZDAMPSMMA2424A	24 VAC	Rectangular-Side Mount Actuator	24	24
ZDAMPSMMA2606A	24 VAC	Rectangular-Side Mount Actuator	26	6
ZDAMPSMMA2608A	24 VAC	Rectangular-Side Mount Actuator	26	8
ZDAMPSMMA2610A	24 VAC	Rectangular-Side Mount Actuator	26	10
ZDAMPSMMA2612A	24 VAC	Rectangular-Side Mount Actuator	26	12
ZDAMPSMMA2614A	24 VAC	Rectangular-Side Mount Actuator	26	14
ZDAMPSMMA2616A	24 VAC	Rectangular-Side Mount Actuator	26	16
ZDAMPSMMA2618A	24 VAC	Rectangular-Side Mount Actuator	26	18
ZDAMPSMMA2620A	24 VAC	Rectangular-Side Mount Actuator	26	20
ZDAMPSMMA2622A	24 VAC	Rectangular-Side Mount Actuator	26	22
ZDAMPSMMA2624A	24 VAC	Rectangular-Side Mount Actuator	26	24
ZDAMPSMMA2626A	24 VAC	Rectangular-Side Mount Actuator	26	26
ZDAMPSMMA2806A	24 VAC	Rectangular-Side Mount Actuator	28	6
ZDAMPSMMA2808A	24 VAC	Rectangular-Side Mount Actuator	28	8
ZDAMPSMMA2810A	24 VAC	Rectangular-Side Mount Actuator	28	10
ZDAMPSMMA2812A	24 VAC	Rectangular-Side Mount Actuator	28	12
ZDAMPSMMA2814A	24 VAC	Rectangular-Side Mount Actuator	28	14
ZDAMPSMMA2816A	24 VAC	Rectangular-Side Mount Actuator	28	16
ZDAMPSMMA2818A	24 VAC	Rectangular-Side Mount Actuator	28	18
ZDAMPSMMA2820A	24 VAC	Rectangular-Side Mount Actuator	28	20
ZDAMPSMMA2822A	24 VAC	Rectangular-Side Mount Actuator	28	22
ZDAMPSMMA2824A	24 VAC	Rectangular-Side Mount Actuator	28	24
ZDAMPSMMA2826A	24 VAC	Rectangular-Side Mount Actuator	28	26
ZDAMPSMMA2828A	24 VAC	Rectangular-Side Mount Actuator	28	28
ZDAMPSMMA3006A	24 VAC	Rectangular-Side Mount Actuator	28	6
ZDAMPSMMA3008A	24 VAC	Rectangular-Side Mount Actuator	28	8
ZDAMPSMMA3010A	24 VAC	Rectangular-Side Mount Actuator	28	10
ZDAMPSMMA3012A	24 VAC	Rectangular-Side Mount Actuator	28	12
ZDAMPSMMA3014A	24 VAC	Rectangular-Side Mount Actuator	28	14
ZDAMPSMMA3016A	24 VAC	Rectangular-Side Mount Actuator	28	16
ZDAMPSMMA3018A	24 VAC	Rectangular-Side Mount Actuator	28	18
ZDAMPSMMA3020A	24 VAC	Rectangular-Side Mount Actuator	28	20
ZDAMPSMMA3022A	24 VAC	Rectangular-Side Mount Actuator	28	22
ZDAMPSMMA3024A	24 VAC	Rectangular-Side Mount Actuator	28	24
ZDAMPSMMA3026A	24 VAC	Rectangular-Side Mount Actuator	28	26
ZDAMPSMMA3028A	24 VAC	Rectangular-Side Mount Actuator	28	28
ZDAMPSMMA3030A	24 VAC	Rectangular-Side Mount Actuator	28	30

24 Volt Modulating Dampers - Bottom Mount

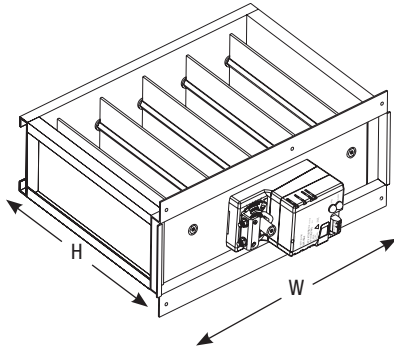

Rectangular Dampers with Bottom Mount Actuator

Rectangular Dampers with Bottom Mount Actuator

- 24 VAC Powered open/Powered closed
- Three wire connection - 18 gauge
- 1.5 VA damper actuator with 60 second travel time
- 18 in. lbs. of torque
- Manual gear release
- Screw terminal blocks
- 97% leak proof rating
- Sturdy aluminum blades and frame
- Motor is always located on the second dimension of the model number, i.e ZDAMP*MMA1012A will have the motor mounted on the 12" dimension

Table CCZO-17-A – Specifications: Rectangular Dampers with Bottom Mount Actuator

Model Number	Power Supply	Description	Uncrated Dimensions (in.)	
			H	W
ZDAMPBMMMA0810A	24 VAC	Rectangular-Bottom Mount Actuator	8	10
ZDAMPBMMMA0812A	24 VAC	Rectangular-Bottom Mount Actuator	8	12
ZDAMPBMMMA0814A	24 VAC	Rectangular-Bottom Mount Actuator	8	14
ZDAMPBMMMA0816A	24 VAC	Rectangular-Bottom Mount Actuator	8	16
ZDAMPBMMMA0818A	24 VAC	Rectangular-Bottom Mount Actuator	8	18
ZDAMPBMMMA0820A	24 VAC	Rectangular-Bottom Mount Actuator	8	20
ZDAMPBMMMA0822A	24 VAC	Rectangular-Bottom Mount Actuator	8	22
ZDAMPBMMMA0824A	24 VAC	Rectangular-Bottom Mount Actuator	8	24
ZDAMPBMMMA0826A	24 VAC	Rectangular-Bottom Mount Actuator	8	26
ZDAMPBMMMA0828A	24 VAC	Rectangular-Bottom Mount Actuator	8	28
ZDAMPBMMMA0830A	24 VAC	Rectangular-Bottom Mount Actuator	8	30
ZDAMPBMMMA1012A	24 VAC	Rectangular-Bottom Mount Actuator	10	12
ZDAMPBMMMA1014A	24 VAC	Rectangular-Bottom Mount Actuator	10	14
ZDAMPBMMMA1016A	24 VAC	Rectangular-Bottom Mount Actuator	10	16
ZDAMPBMMMA1018A	24 VAC	Rectangular-Bottom Mount Actuator	10	18
ZDAMPBMMMA1020A	24 VAC	Rectangular-Bottom Mount Actuator	10	20
ZDAMPBMMMA1022A	24 VAC	Rectangular-Bottom Mount Actuator	10	22
ZDAMPBMMMA1024A	24 VAC	Rectangular-Bottom Mount Actuator	10	24
ZDAMPBMMMA1026A	24 VAC	Rectangular-Bottom Mount Actuator	10	26
ZDAMPBMMMA1028A	24 VAC	Rectangular-Bottom Mount Actuator	10	28
ZDAMPBMMMA1030A	24 VAC	Rectangular-Bottom Mount Actuator	10	30
ZDAMPBMMMA1214A	24 VAC	Rectangular-Bottom Mount Actuator	12	14
ZDAMPBMMMA1216A	24 VAC	Rectangular-Bottom Mount Actuator	12	16
ZDAMPBMMMA1218A	24 VAC	Rectangular-Bottom Mount Actuator	12	18
ZDAMPBMMMA1220A	24 VAC	Rectangular-Bottom Mount Actuator	12	20
ZDAMPBMMMA1222A	24 VAC	Rectangular-Bottom Mount Actuator	12	22
ZDAMPBMMMA1224A	24 VAC	Rectangular-Bottom Mount Actuator	12	24
ZDAMPBMMMA1226A	24 VAC	Rectangular-Bottom Mount Actuator	12	26
ZDAMPBMMMA1228A	24 VAC	Rectangular-Bottom Mount Actuator	12	28
ZDAMPBMMMA1230A	24 VAC	Rectangular-Bottom Mount Actuator	12	30
ZDAMPBMMMA1416A	24 VAC	Rectangular-Bottom Mount Actuator	14	16
ZDAMPBMMMA1418A	24 VAC	Rectangular-Bottom Mount Actuator	14	18
ZDAMPBMMMA1420A	24 VAC	Rectangular-Bottom Mount Actuator	14	20
ZDAMPBMMMA1422A	24 VAC	Rectangular-Bottom Mount Actuator	14	22
ZDAMPBMMMA1424A	24 VAC	Rectangular-Bottom Mount Actuator	14	24
ZDAMPBMMMA1426A	24 VAC	Rectangular-Bottom Mount Actuator	14	26
ZDAMPBMMMA1428A	24 VAC	Rectangular-Bottom Mount Actuator	14	28
ZDAMPBMMMA1430A	24 VAC	Rectangular-Bottom Mount Actuator	14	30
ZDAMPBMMMA1618A	24 VAC	Rectangular-Bottom Mount Actuator	16	18
ZDAMPBMMMA1620A	24 VAC	Rectangular-Bottom Mount Actuator	16	20
ZDAMPBMMMA1622A	24 VAC	Rectangular-Bottom Mount Actuator	16	22
ZDAMPBMMMA1624A	24 VAC	Rectangular-Bottom Mount Actuator	16	24
ZDAMPBMMMA1626A	24 VAC	Rectangular-Bottom Mount Actuator	16	26
ZDAMPBMMMA1628A	24 VAC	Rectangular-Bottom Mount Actuator	16	28
ZDAMPBMMMA1630A	24 VAC	Rectangular-Bottom Mount Actuator	16	30
ZDAMPBMMMA1820A	24 VAC	Rectangular-Bottom Mount Actuator	18	20
ZDAMPBMMMA1822A	24 VAC	Rectangular-Bottom Mount Actuator	18	22
ZDAMPBMMMA1824A	24 VAC	Rectangular-Bottom Mount Actuator	18	24
ZDAMPBMMMA1826A	24 VAC	Rectangular-Bottom Mount Actuator	18	26
ZDAMPBMMMA2022A	24 VAC	Rectangular-Bottom Mount Actuator	20	22
ZDAMPBMMMA2024A	24 VAC	Rectangular-Bottom Mount Actuator	20	24

For complete equipment / combination selections, installation instructions and warranty information, please refer to Product Data/Ratings and/or Installers Guides and Limited Warranty Handbooks.



It's Hard To Stop A Trane.®

24 Volt Modulating Dampers

Table CCZO-18-A — Rectangular Damper Net Free Area

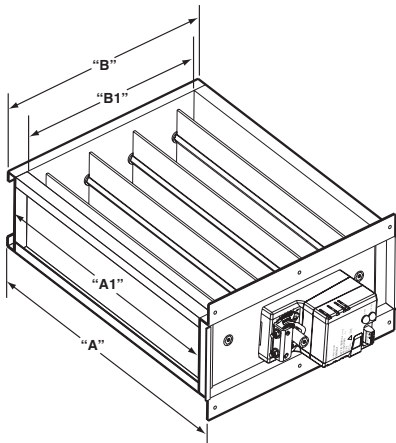

Listed Size	Actual Outside Size	Actual Inside Size	8	10	12	14	16	18	20	22	24	26	28	30	Listed Size	High
			7.813	9.813	11.813	13.813	15.813	17.813	19.813	21.813	23.813	25.813	27.813	29.813	Act. Outside Size B	
			5.813	7.813	9.813	11.813	13.813	15.813	17.813	19.813	21.813	23.813	25.813	27.813	Act. Inside Size B1	
Wide	A	A1	3	3	4	5	6	7	7	8	9	10	11	11	No. of Blades	
6	5.812	4.313	19.5	28.1	34.9	41.6	48.6	55.1	63.8	70.5	77.3	84.0	90.8	99.4		
8	7.812	6.313	28.5	41.1	51.0	60.9	70.8	80.7	93.3	103.2	113.1	123.0	132.9	145.5		
10	9.812	8.313	37.5	54.2	67.2	80.2	93.2	106.3	122.9	135.9	148.9	162.0	175.0	191.6		
12	11.812	10.313	46.5	67.2	83.3	99.5	115.7	131.8	152.5	168.6	184.8	200.9	217.1	237.7		
14	13.812	12.313	55.6	80.2	99.5	118.8	138.1	157.4	182.0	201.3	220.6	239.9	259.2	283.8		
16	15.812	14.313	64.6	93.2	115.7	138.1	160.5	183.0	211.6	234.0	256.4	278.9	301.3	329.9		
18	17.812	16.313	73.6	106.3	131.8	157.4	183.0	208.5	241.1	266.7	292.3	317.8	343.4	376.0		
20	19.812	18.313	82.7	119.3	148.0	176.7	205.4	234.1	270.7	299.4	328.1	356.8	385.5	422.1		
22	21.812	20.313	91.7	132.3	164.2	196.0	227.8	259.6	300.3	332.1	363.9	395.8	427.6	468.2		
24	23.812	22.313	100.7	145.4	180.3	215.3	250.2	285.2	329.8	364.8	399.8	435.2	469.7	514.3		
26	25.812	24.313	109.8	158.4	196.5	234.6	272.7	310.8	359.4	397.5	435.6	473.7	511.8	560.4		
28	27.812	26.313	118.8	171.4	212.6	253.9	295.1	336.3	389.0	430.2	471.4	512.7	553.8	606.5		
30	29.812	28.313	127.8	184.4	228.8	273.2	317.5	361.9	418.5	462.9	507.3	551.6	596.0	652.6		



It's Hard To Stop A Trane.®

Programmable Touchscreen Thermostats

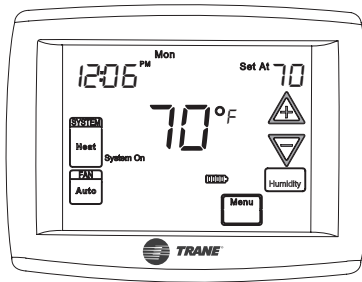

TCONT303AS42DA

TCONT303AS42DA

- 5" Diagonal Touchscreen
- Built-in Humidity sensor
- Programmable: 7 day, 5/1/1 day, or none
- Common preferred, not required with 2AA battery power (included)
- Simple to install and use
- 5" diagonal touchscreen
- Remote wired indoor or outdoor sensor option
- Control with one indoor sensor or average with thermostat internal sensor
- Armchair Programming (requires batteries)
- Cooling dehumidification (DHM) (normally closed relay; opens, 24V to BK)
- Humidifier Relay (HM)

Application:

- Up to 4 Heat/2 Cool (Gas, Oil or Electric) / HP / Dual Fuel
- ZZSENSAL0300AA - Remote Indoor Temperature Sensor
- BAYSEN30ATEMPA - Remote Outdoor Temperature Sensor

Dimensions:

- 4.56" h x 5.81" h x 1.18" d
- Finish: Bright White

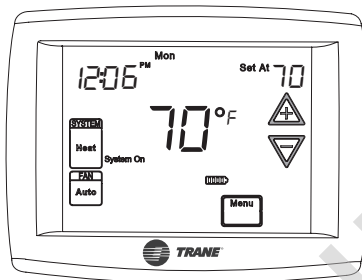

TCONT302AS42DA

TCONT302AS42DA

- 5" Diagonal Touchscreen
- Programmable: 7 day, 5/1/1 day, or none
- Common preferred, not required with 2AA battery power (included)
- Simple to install and use
- 5" diagonal touchscreen
- Remote wired indoor or outdoor sensor option
- Control with one indoor sensor or average with thermostat internal sensor
- Armchair Programming (requires batteries)

Application:

- Up to 4 Heat/2 Cool (Gas, Oil or Electric) / HP / Dual Fuel
- ZZSENSAL0300AA - Remote Indoor Temperature Sensor
- BAYSEN30ATEMPA - Remote Outdoor Temperature Sensor

Dimensions:

- 4.56" h x 5.81" h x 1.18" d
- Finish: Bright White



It's Hard To Stop A Trane.®

Programmable Thermostats

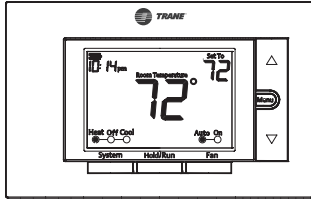

TCONT203AS42MA

TCONT203AS42MA

4 Heat/2 Cool

- 5/1/1 or 7 day Programming
- Simple to Install and Use
- 3.5" Diagonal, Backlit Display
- Common preferred, not required with 2AA battery power (included)
- Easy to follow Sequential Programming
- Indoor and setpoint temperatures displayed simultaneously
- Easy battery access
- Easy to understand soft key controls

Application:

- Up to 4 Heat/2 Cool (Gas, Oil or Electric) / HP / Dual Fuel (non-restricted mode only)

Dimensions:

- 3.75" h x 6.0" w x 1.12" d
- Finish: Bright White

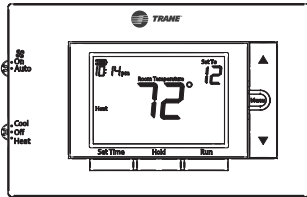

TCONT202AS11MA

TCONT202AS11MA

1 Heat/1 Cool

- 5/1/1 or 7 day Programming
- Simple to Install and Use
- 3.5" Diagonal, Backlit Display
- Common preferred, not required with 2AA battery power (included)
- Standard Wiring Terminal Block
- Easy to follow Sequential Programming
- Indoor and setpoint temperatures displayed simultaneously
- No auxiliary heat capability
- Easy battery access
- Easy to understand soft key controls

Application:

- 1 Heat/1 Cool

Dimensions:

- 3.75" h x 6.0" w x 1.12" d
- Finish: Bright White



It's Hard To Stop A Trane.®

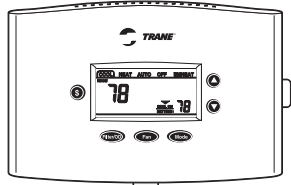

TCONT402A

Non-Programmable Comfort Controls

TCONT402AN32DA

- Auto Changeover
- Backlit Display & Keys
- Comfort Information Compartment
- Energy Savings Mode
- Filter Reminder
- BAYSEN01ATEMPA- Outdoor Temperature Sensor included*
- Keypad Lock

Application (3-9 Wire Hookup -2 for Outdoor Sensor) Heat Pump* or A/C

- 3 Heat/2 Cool
- No external Dual Fuel Kit Required
- Do not use with TAYPLUS103A
- ZZSENSAL0400AA - Remote Indoor Temperature Sensor

Dimensions:

- 6.75" w x 4.52" h x 1.20" d
- Finish: Bright White
- Requires external relay for oil furnace applications.
- Installation is required for outdoor temperature sensing and display



It's Hard To Stop A Trane.®

Non-Programmable Comfort Controls

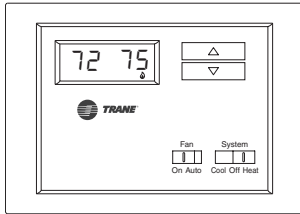

TCONT103A

TCONT103AN21MA

2 Heat/1 Cool

- Push Button, Non-Programmable
- 1.9" Diagonal Display
- Configurable Switchover Valve
- Emergency Heat
- Common required
- Fahrenheit or Celsius
- Keypad Lock

Application

- Up to 2 Heat/1Cool (HP only)
- 1 Stage Compressor
- 1 Stage Auxiliary Heat

Dimensions:

- 3.88" h x 5.5" h x 1.18" d
- Finish: Bright White

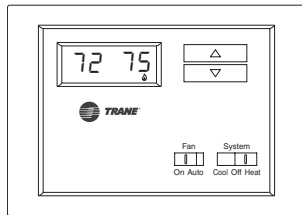

TCONT102A

TCONT102AN11AA

1 Heat/1 Cool

- Push Button, Non-Programmable
- 1.9" Diagonal Display
- No Common Terminal
- Battery Powered Only (Batteries included)
- RH / RC Jumper
- Fahrenheit or Celsius

Application

- Up to 1Heat/1 Cool (Gas, Oil or Electric)
- Finish: Bright White

Dimensions:

- 3.88" h x 5.5" h x 1.18" d
- Finish: Bright White

Remote Sensors



BAYSEN02ATEMPA

- Outdoor Temperature Sensor for use with TCONT800, 802, 803
- Accuracy +/- 1°F from -40 to 120°F

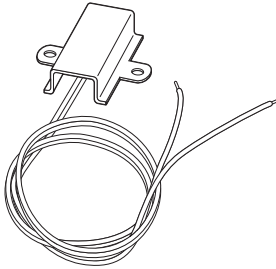

BAYSEN01ATEMPA

- Outdoor Temperature Sensor for use with TZON1050AC, TZONE950AC, TCONT850AC, TCONT824AS, TCONT624AS, TCONT402AN, TCONT401AN, BAY24VRPAC52D*.
- Accuracy +/- 1.5°F over 32°F to 100°F
- Display Range -40°F to 140°F

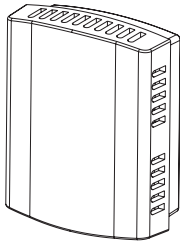

ZZSENSAL0400AA

- Indoor Wired Sensor for use with TZON1050AC, TZONE950AC, TCONT850AC, TCONT824AS, TCONT624AS, TCONT402AN, BAY24VRPAC52D*.
- Operating Ambient Temperature Range: 20° to 120°F (-6.7° to 48.9°C)
- Display Range: 20° to 120°F (-6.7° to 48.9°C)
- Sensor Accuracy: +/- .5°F at 75°F
- Operating Relative Humidity: 5% to 90% non-condensing

Dimensions in in. (mm):

- 1.54 (39)w x 1.93 (49)h x .625 (16)d
- Storage Temperature: -40° to 140°F (-40° to 60°C)
- Finish: White

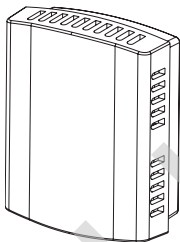

ZZSENSAL0800AA

- Indoor Wired Temperature Sensor for use with TCONT800, TCONT802, TCONT803
- Operating Ambient Temperature Range: 20° to 120°F (-6.7° to 48.9°C)
- Display Range: 0 to 99°F (-18 to 37°C)
- Sensor Accuracy: +/-1.5°F at 70°F (+/- .84 at 21°C)
- Operating Relative Humidity: 5% to 95% non-condensing

Dimensions in in. (mm):

- 1.54 (39)w x 1.93 (49)h x .625 (16)d
- Storage Temperature: -40° to 140°F (-40° to 60°C)
- Finish: White

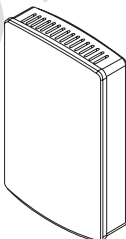

ZSENS930AW00MA

- Indoor Wireless Temperature and Humidity Sensor for use with TCONT824, TCONT850, TZON1050
- Operating Ambient Temperature Range: 32° to 104°F (0° to 40°C)
- Power Supply: Two AAA alkaline batteries
- Sensor Accuracy: +/-1°F over the sensing range of 32°F to 120°F (0° to 48.9°C)
- Operating Relative Humidity: 10% to 90% non-condensing

Dimensions in in. (mm):

- 2.0" (51)w x 3.25" (83)h x .6 (15)d
- Storage Temperature: -40° to 140°F (-40° to 65°C)
- Finish: White

For complete equipment / combination selections, installation instructions and warranty information, please refer to Product Data/Ratings and/or Installers Guides and Limited Warranty Handbooks.

Outdoor Thermostat Kit

TAYSTAT250B

- The outdoor thermostat (ODT) is designed to turn "ON" the supplementary heater at a pre-selected outdoor temperature.
- The number and setting of the ODT is dependent on the heat loss of the structure and capacity of the heating system installed.
- This model ODT gives a temperature range for 44°F to -10°F (See figure 1 for settings). The switching action is single pole/double throw, opening on temperature rise and closing on temperature fall, completing the circuit through the thermostat.

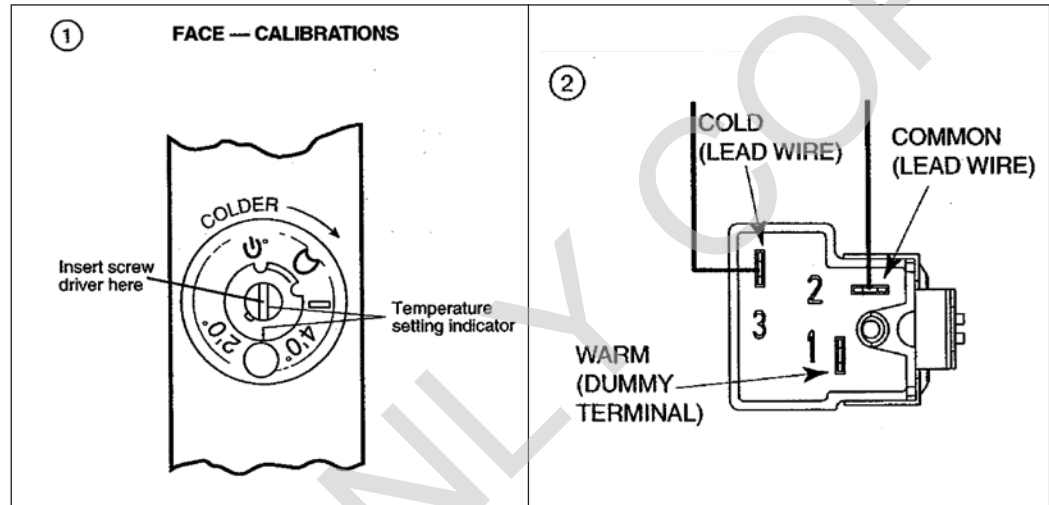

Packaged Cooling Convertible 2-5 Tons

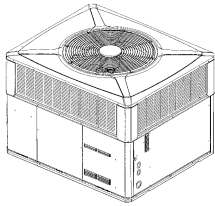

**4TCC4
13.4 SEER2
1-Phase**

Table PK-1-C – 4TCC4 - XR13.4c (13.4 SEER2) - Convertible Packaged Cooling - R-410A

Model Number	Cooling Capacity (BTUH)	SEER2/EER2	Shipping Weight	MCA	Max Fuse	Sound Rating	Uncrated Dimensions (in.) H x D x W
4TCC4 (13.4 SEER2) – 208-230/1/60							
4TCC4024E1000A	23,200	13.40/11.00	432	16.7	25	67	36 x 42 x 49
4TCC4030E1000A	28,000	13.40/11.00	451	20.8	30	70	36 x 42 x 49
4TCC4036E1000A	36,400	13.40/11.00	453	26.2	40	69	38 x 42 x 49
4TCC4042E1000A	39,500	13.40/11.00	561	28.3	45	75	36 x 45 x 59
4TCC4048E1000A	46,000	13.40/10.80	557	31.8	50	73	40 x 45 x 59
4TCC4060E1000A	57,000	13.40/11.00	586	39.1	60	73	40 x 45 x 59

ONLINE ONLY COPY

**For dimensional/outline drawings, please refer to Product Data.
For information on Roof Curbs, please refer to the Accessories/Information Tab.**

For complete equipment / combination selections, installation instructions and warranty information, please refer to Product Data/Ratings and/or Installers Guides and Limited Warranty Handbooks.



TRANE[®]

It's Hard To Stop A Trane.[®]

Packaged Cooling Convertible 2-5 Tons

Table PK-2-A – Features 2-5

	4TCC4 2-5
• SEER2 up to	13.4
• Exclusive Climatuff™ high efficiency compressor with internal overload protection	✓
• Factory supplied charge.....	R-410A
• Composite Vortica® indoor blower	✓
• Direct drive, variable speed ECM blower motor**	-
• Direct drive, multi-speed ECM blower motor (high efficiency)*	✓
• All aluminum Spine Fin™ outdoor coil.....	✓
• Swept-blade outdoor fan for quiet operation	✓
• Architecturally integrated louvers and corner guards	-
• All steel louvers	✓
• Polyslate gray cabinet	✓
• Single stage cooling.....	✓
• High pressure cutout.....	✓
• Low pressure cutout	✓
• Liquid line drier - factory installed.....	✓
• Non-bleed expansion valves on indoor coil	✓
• Pressure taps, including liquid line taps, easily accessed and protected inside compressor compartment	✓
• Right side electrical service access for high and low voltage connections	✓
• Rugged steel basepan features deep drawn duct connections	✓
• Steeply sloped composite drainpan	✓
• Ships in horizontal configuration and converts quickly for downflow	✓
• Copper tube, aluminum fin indoor coil.....	5
• All aluminum indoor coil.....	2-4
• All models are certified to UL 1995.....	✓
• 20-year heat exchanger, 10-year compressor, 10-year coils, and 10-year all other functional parts limited warranty with registration† (Residential use).....	✓
• Extended warranties available.....	✓

* Constant torque ECM (electronically commutated motor).

**Constant airflow ECM (electronically commutated motor).

† Registered Limited Warranty terms are available when you register within 60 days of installation. You can register online at Trane.com or by phone at 855-260-2975, otherwise Trane's Base Limited Warranty terms will apply. Base Limited Warranty information on specific products can be found on Trane.com. Ask your dealer for full warranty information at time of purchase. Warranties are for residential and multi-family use only, some exclusions may apply.

For dimensional/outline drawings, please refer to Product Data.

For information on Roof Curbs, please refer to the Accessories/Information Tab.

For complete equipment / combination selections, installation instructions and warranty information, please refer to Product Data/Ratings and/or Installers Guides and Limited Warranty Handbooks.

Packaged Cooling Convertible 2-5 Tons

Table PK-3-A — Accessories

Model Number	Description	Shipping Weight	4TCC4 2-5
BAYACCDOR1A...	Hinged Filter Access Door®.....		2-3
BAYACCDOR2A...	Hinged Filter Access Door®.....		3½-5
BAYACCEADP1A..	Adaptor Kit for Installation of CleanEffects™ and 5" Media Filter (Horizontal)⑨.....	10.....	2-3
BAYACCEADP2A..	Adaptor Kit for Installation of CleanEffects™ and 5" Media Filter (Horizontal)⑨.....	12.....	3½-5
BAYADAP050A	Adapter Curb (Cabinet A/B).....		2-3
BAYADAP051A	Adapter Curb (Cabinet C).....		2-3
BAYADAP052A	Adapter Curb (Cabinet A/B).....		3½-5
BAYADAP053A	Adapter Curb (Cabinet C).....		3½-5
BAYADAP054A	Adapter Curb (Cabinet D).....		3½-5
BAYASCT001	Anti-Short Cycle Timer 4.....		—
BAYCCHT102A....	Crankcase Heater (230V) (Scroll).....		3½-5
BAYCCHT103A....	Crankcase Heater (230V) (Scroll).....		2-3
BAYCOVR112A....	12" Duct Shroud (Covers Horizontal Ducts)⑤.....		2-5
BAYCOVR118A....	18" Duct Shroud (Covers Horizontal Ducts) ⑤.....		2-5
BAYCURB050A....	Flat Roof Full Perimeter Curb (Insulated)	74.....	2-3
BAYCURB051A....	Flat Roof Full Perimeter Curb (Insulated)	74.....	3½-5
BAYDMPR101A ...	2-Position Motorized Fresh Air Damper1⑥⑦⑧⑨.....		2-3
BAYDMPR102A ...	2-Position Motorized Fresh Air Damper1⑥⑦⑧⑨.....		3½-5
BAYECON101A....	Economizer with Barometric Relief (Downflow)①②③④⑤.....	50.....	2-3
BAYECON102A....	Economizer with Barometric Relief (Downflow)①②③④⑤.....	65.....	3½-5
BAYECON104A....	Economizer with Barometric Relief (Downflow)①②③④⑤.....	65.....	—
BAYECON200A....	Economizer (Horizontal)①②③④.....	85.....	2-3
BAYECON201A....	Economizer (Horizontal)①②③④.....	85.....	3½-5
BAYECON204A....	Economizer (Horizontal)①②③④.....	85.....	—
BAYENTH001A ...	Enthalpy Control Kit②.....	2.....	✓
BAYEXMK001A....	Extreme Conditions Mounting Kit (Used on BAYCURB & BAYADAP).....		✓
BAYEXMK002B ...	Extreme Conditions Mounting Kit (Used on BAYUTIL).....		✓
BAYEXMK003A....	Extreme Conditions Mounting Kit (Used on Slab Mounts).....		✓
BAYFLTR101C	1-2" Filter Frame (requires one 18x25 filter which is not included)①.....	6.....	2-3
BAYFLTR201C	1-2" Filter Frame (requires one 18x20 and one 18x18 filter which are not included)① ⑩.....	6.....	3½-5
BAYLIFT002B	Lifting Lug Kit	5.....	✓
BAYLOAM011A ...	Evaporator Defrost Control Kit.....		✓
BAYLOAM105A ...	Low Ambient Control Kit.....	5.....	✓
BAYOSAH001A....	Manual Fresh Air Damper①.....	6.....	2-3
BAYOSAH002A....	Manual Fresh Air Damper①.....	8.....	3½-5
BAYQSTK300A	Start Kit (not factory installed).....		✓
BAYSQRD001B....	16" Round Duct Adapter®.....	5.....	2-3
BAYSQRD002B....	18" Round Duct Adapter®.....	3.....	2-5
BAYUTIL101B.....	Roof Curb Utility Extension Kit.....		2-3
BAYUTIL102B.....	Roof Curb Utility Extension Kit.....		3½-5

- ① Must use filter frame when economizer/fresh air kit is used.
- ② Dry bulb control standard with economizer.
- ③ 2-Stage cooling control required when using economizer.
- ④ Do not use with electronic thermostats.
- ⑤ BAYCOVR112,118A will not cover BAYSQRD002B applications.
- ⑥ Does not contain barometric relief.
- ⑦ Max fresh air - 25%.
- ⑧ For non-continuous fan gas-heating applications, the damper opens only when the OD ambient is above 50° F.
- ⑨ It is the designer/engineer/installer's responsibility to review product specifications and technical literature to insure optimal performance and compliance to codes.
- ⑩ Temperature of mixed air entering the heat exchanger is monitored and fresh air intake may be reduced under certain conditions.
- ⑪ BAYACCDOR1A requires BAYFLTR101B & BAYACCDOR2A requires BAYFLTR201B. They are not backward compatible to BAYFLTR101/201A.
- ⑫ When using a BAYACCDOR2A, two 18x20 filters are required.

EXISTING CURB	NEW UNIT 4TCY4/5	USE BAYADAP0**A
BAYCURB030,38A	024-036	50
BAYCURB030,38A	042-060	52
BAYCURB033A	024-036	51
BAYCURB033A	042-060	53
BAYCURB034A	042-060	54

**For dimensional/outline drawings, please refer to Product Data.
For information on Roof Curbs, please refer to the Accessories/Information Tab.**

For complete equipment / combination selections, installation instructions and warranty information, please refer to Product Data/Ratings and/or Installers Guides and Limited Warranty Handbooks.

TRANE®

It's Hard To Stop A Trane.®

Packaged Hybrid/Dual Fuel Convertible 2-5 Tons

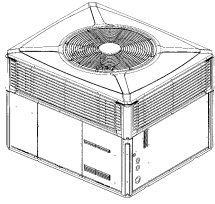

4DCZ5
15.0 SEER2
1-Phase

Table PK-4-A – 4DCZ5 - XL15c - Convertible Packaged Dual Fuel - R-410A

Model Number	Cooling Capacity (BTUH)	Gas Capacity Heating Output	SEER2/EER2	HSPF2	AFUE(%)	Shipping Weight	MCA	Max Fuse	Sound Rating	Shipping Dimensions (in.) H x D x W
4DCZ5 – 208-230/1/60										
4DCZ5024E1060A	23,800	22,800	15.00/11.00	7.25	81.0	488	19.5	30	67	48 x 45 x 52
4DCZ5036E1070A	35,200	31,000	15.00/11.00	6.70	81.0	488	24.3	35	70	48 x 45 x 52
4DCZ5048E1090A	47,500	43,000	15.00/11.00	6.70	81.0	665	34.2	50	72	52 x 47 x 62
4DCZ5060E1115A	56,500	55,500	14.56/11.0	7.45	81.0	676	42.0	60	74	52 x 47 x 62

For dimensional/outline drawings, please refer to Product Data.

For information on Roof Curbs, please refer to the Accessories/Information Tab.

For complete equipment / combination selections, installation instructions and warranty information, please refer to Product Data/Ratings and/or Installers Guides and Limited Warranty Handbooks.



Packaged Hybrid/Dual Fuel Convertible 2-5 Tons

Table PK-2-A – Features 2-5

	4DCZ5 2-5
• SEER2 up to.....	15.0
• HSPF2 up to.....	7.45
• Exclusive Climatuff™ high efficiency compressor with internal overload protection.....	✓
• Factory supplied charge.....	R-410A
• Composite Vortica® indoor blower**.....	✓
• Direct drive, variable speed ECM blower motor.....	✓
• All aluminum Spine Fin™ outdoor coil.....	✓
• Swept-blade outdoor fan for quiet operation.....	✓
• Architecturally integrated louvers and corner guards.....	✓
• Polyslate gray cabinet.....	✓
• Stainless steel heat exchanger and burners.....	✓
• Two stage heating & cooling.....	✓
• 2-stage gas.....	✓
• High pressure cutout.....	✓
• Low pressure cutout.....	✓
• Liquid line drier - factory installed.....	✓
• Non-bleed expansion valves on indoor and outdoor coils.....	✓
• Pressure taps, including liquid line taps, easily accessed and protected inside compressor compartment.....	✓
• Right side electrical service access for high and low voltage connections.....	✓
• Rugged steel basepan features deep drawn duct connections.....	✓
• Steeply sloped composite drainpan.....	✓
• Ships in horizontal configuration and converts quickly for downflow.....	✓
• Copper tube, aluminum fin indoor coil.....	✓
• All models are certified to UL 1995.....	✓
• 20-year heat exchanger, 12-year compressor, 10-year coils, & 10-year all other functional parts limited warranty with registration† (Residential use).....	✓
• Extended Warranties Available.....	✓

** Constant airflow ECM (electronica)

† Registered Limited Warranty terms are available when you register within 60 days of installation. You can register online at Trane.com or by phone at 855-260-2975, otherwise Trane's Base Limited Warranty terms will apply. Base Limited Warranty information on specific products can be found on Trane.com. Ask your dealer for full warranty information at time of purchase. Warranties are for residential and multi-family use only, some exclusions may apply.

**For dimensional/outline drawings, please refer to Product Data.
For information on Roof Curbs, please refer to the Accessories/Information Tab.**

For complete equipment / combination selections, installation instructions and warranty information, please refer to Product Data/Ratings and/or Installers Guides and Limited Warranty Handbooks.

TRANE®

It's Hard To Stop A Trane.®

Packaged Hybrid/Dual Fuel Convertible 2-5 Tons

Table PK-6-A — Accessories

Model Number	Description	Shipping Weight	4DCZ5 2-5
BAYACCDOR1A.....	Hinged Filter Access Door ⑩.....		2-3
BAYACCDOR2A.....	Hinged Filter Access Door ⑩.....		4-5
BAYACCEADP1A.....	Adaptor Kit for Installation of CleanEffects™ and 5" Media Filter (Horizontal) ⑩.....	10	2-3
BAYACCEADP2A.....	Adaptor Kit for Installation of CleanEffects™ and 5" Media Filter (Horizontal) ⑩.....	12	4-5
BAYADAP050A.....	Adapter Curb (Cabinet A/B).....		2-3
BAYADAP051A.....	Adapter Curb (Cabinet C).....		2-3
BAYADAP052A.....	Adapter Curb (Cabinet A/B).....		4-5
BAYADAP053A.....	Adapter Curb (Cabinet C).....		4-5
BAYADAP054A.....	Adapter Curb (Cabinet D).....		4-5
BAYASCT001.....	Anti-Short Cycle Timer ⑩.....		✓
BAYCCHT102A.....	Crankcase Heater (230V) (Scroll).....		4-5
BAYCCHT103A.....	Crankcase Heater (230V) (Scroll).....		2-3
BAYCCHT404B.....	Crankcase Heater (460V) (Scroll).....		4-5
BATCCHT405A.....	Crankcase Heater (460V) (Scroll).....		2-3
BAYCOVR112A.....	12" Duct Shroud (Covers Horizontal Ducts) ⑩.....		2-5
BAYCOVR118A.....	18" Duct Shroud (Covers Horizontal Ducts) ⑩.....		2-5
BAYCURB050A.....	Flat Roof Full Perimeter Curb (Insulated).....	74	2-3
BAYCURB051A.....	Flat Roof Full Perimeter Curb (Insulated).....	74	4-5
BAYDMPR101A.....	2-Position Motorized Damper ②⑦⑧⑨⑩.....		2-3
BAYDMPR102A.....	2-Position Motorized Damper ②⑦⑧⑨⑩.....		4-5
BAYECON101A.....	Economizer with Barometric Relief (Downflow) ①②③④⑩⑩.....		-
BAYECON102A.....	Economizer with Barometric Relief (Downflow) ①②③④⑩⑩.....		-
BAYECON103A.....	Economizer with Barometric Relief (Downflow) ①②③④⑩⑩.....	50	2-3
BAYECON104A.....	Economizer with Barometric Relief (Downflow) ①②③④⑩⑩.....	65	4-5
BAYECON200A.....	Economizer (Horizontal) ①②③④⑦.....		-
BAYECON201A.....	Economizer (Horizontal) ①②③④⑦.....		-
BAYECON203A.....	Economizer (Horizontal) ①②③④⑦.....	85	2-3
BAYECON204A.....	Economizer (Horizontal) ①②③④⑦.....	85	4-5
BAYENTH001A.....	Enthalpy Control Kit ⑩.....	2	✓
BAYEXMK001A.....	Extreme Conditions Mounting Kit.....		✓
BAYEXMK002B.....	Extreme Conditions Mounting Kit.....		✓
BAYEXMK003A.....	Extreme Conditions Mounting Kit (Used on Slab Mounts).....		✓
BAYFLTR101C.....	1-2" Filter Frame ② -Requires one 18x25 filter (not included).....	6	2-3
BAYFLTR201C.....	1-2" Filter Frame ② ⑩ - Requires one 18x20 and one 18x18 (not included).....	6	4-5
BAYLIFT002B.....	Lifting Lug Kit.....	5	✓
BAYLOAM105A.....	Low Ambient Control Kit.....	5	✓
BAYRLAY004A.....	Economizer Relay ①.....		-
BAYRLAY006A.....	Economizer Relay ①.....	1	✓
BAYOSAC001B.....	Outside Air Control for V.S. Economizer ⑩.....		2-5
BAYOSAH001A.....	Manual Fresh Air Damper ②.....	6	2-3
BAYOSAH002A.....	Manual Fresh Air Damper ②.....	8	4-5
BAYQSTK300A.....	Start Kit (not factory installed).....		✓
BAYSQRD001B.....	16" Round Duct Adapter ⑤.....	5	2-3
BAYSQRD002B.....	18" Round Duct Adapter ⑤.....	3	4-5
BAYUTIL101B.....	Roof Curb Extension Kit.....		2-3
BAYUTIL102B.....	Roof Curb Extension Kit.....		4-5

① Relay required with economizer on all heat pump applications

② Must use filter frame when economizer/fresh air kit is used.

③ Dry bulb control standard with economizer.

④ 2-Stage cooling control required when using economizer.

⑤ It is the responsibility of the installing dealer to properly size the ductwork for each specific application.

⑥ BAYCOVR112,118A will not cover BAYSQRD002B applications.

⑦ Does not contain barometric relief.

⑧ Max fresh air - 25%.

⑨ For non-continuous fan gas-heating applications, the damper opens only when the OD ambient is above 50° F.

⑩ It is the designer/engineer/installer's responsibility to review product specifications and technical literature to insure optimal performance and compliance to codes.

⑪ Temperature of mixed air entering the heat exchanger is monitored and fresh air intake may be reduced under certain conditions.

⑫ BAYACCDOR1A requires BAYFLTR101B & BAYACCDOR2A requires BAYFLTR201B.They are not backward compatible to BAYFLTR101/201A.

⑬ BAYOASH001/002 is not compatible with BAYACCDOR1A or BAYACCDOR2A.

⑭ When using a BAYACCDOR2A, two 18x20 filters are required.

⑮ Do not use with electronic thermostats.

EXISTING CURB	NEW UNIT 4DC**	USE BAYADAP0**A
BAYCURB030,38A	024-036	50
BAYCURB030,38A	042-060	52
BAYCURB033A	024-036	51
BAYCURB033A	042-060	53
BAYCURB034A	042-060	54

For dimensional/outline drawings, please refer to Product Data.
For information on Roof Curbs, please refer to the Accessories/Information Tab.

For complete equipment / combination selections, installation instructions and warranty information, please refer to Product Data/Ratings and/or Installers Guides and Limited Warranty Handbooks.

Packaged Heat Pump Convertible 2-5 Tons

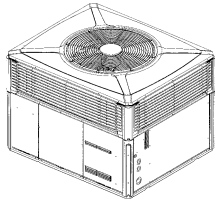

4WCZ6
16.0 SEER
3-Phase

Table PK-7-A — 4WCZ6 - XL16c - Convertible Packaged Heat Pump - R-410A

Model Number	Capacity (BTUH)	SEER	EER High/Low	HSPF	Shipping Weight	MCA	Max Fuse	Sound Rating	Uncrated Dimensions (in.) H x D x W
4WCZ6 – 208-230/3/60									
4WCZ6036B3000A	36,000	16.00	12.20/17.45	8.30	468	19.7	30	70	38 x 42 x 49
4WCZ6048B3000A	47,500	16.00	12.00/17.50	8.50	607	25.2	35	72	42 x 45 x 59
4WCZ6060B3000A	57,000	15.00	11.50/15.90	8.30	623	30.0	45	74	42 x 45 x 59
4WCZ6 – 460/3/60									
4WCZ6036B4000A	36,000	16.00	12.20/17.45	8.30	468	11.9	15	70	38 x 42 x 49
4WCZ6048B4000A	47,500	16.00	12.00/17.50	8.50	607	15.3	20	72	42 x 45 x 59
4WCZ6060B4000A	57,000	15.00	11.50/15.90	8.30	623	17.0	20	74	42 x 45 x 59

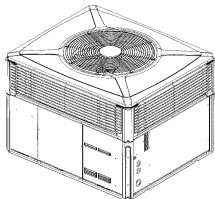

4WCZ5
15.0 SEER
3-Phase

Table PK-7-B — 4WCZ5 - XL15c - Convertible Packaged Heat Pump - R-410A

Model Number	Cooling Capacity (BTUH)	Heating Capacity (BTUH)	SEER2/EER2	HSPF2	Shipping Weight	MCA	Max Fuse	Sound Rating	Shipping Dimensions (in.) H x D x W
4WCZ5 – 208-230/3/60									
4WCZ25036E3000A	IN DEVELOPMENT PLANNED LAUNCH Q1 2023								
4WCZ25048E3000A	IN DEVELOPMENT PLANNED LAUNCH Q1 2023								
4WCZ25060E3000A	IN DEVELOPMENT PLANNED LAUNCH Q1 2023								
4WCZ5 – 208-230/1/60									
4WCZ5036E4000A	IN DEVELOPMENT PLANNED LAUNCH Q1 2023								
4WCZ5048E4000A	IN DEVELOPMENT PLANNED LAUNCH Q1 2023								
4WCZ5060E4000A	IN DEVELOPMENT PLANNED LAUNCH Q1 2023								

4WCZ5
15.0 SEER2
1-Phase

Model Number	Cooling Capacity (BTUH)	Heating Capacity (BTUH)	SEER2/EER2	HSPF2	Shipping Weight	MCA	Max Fuse	Sound Rating	Shipping Dimensions (in.) H x D x W
4WCZ5 – 208-230/1/60									
4WCZ5024E1000A	23,800	22,800	15.00/11.00	7.25	442	19.3	30	67	48 x 45 x 52
4WCZ5030E1000A	IN DEVELOPMENT PLANNED LAUNCH Q1 2023								
4WCZ5036E1000A	35,200	31,000	15.00/11.00	6.7	468	24.3	35	70	48 x 45 x 52
4WCZ5042E1000A	IN DEVELOPMENT PLANNED LAUNCH Q1 2023								
4WCZ5048E1000A	47,500	43,000	15.00/11.00	6.7	607	34.2	50	72	52 x 47 x 62
4TCC4060E1000A	56,500	55,500	14.65/11.00	7.45	623	42.0	60	74	52 x 47 x 62

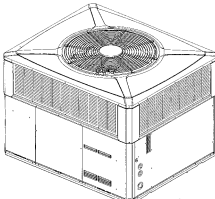

4WCY4
14.0 SEER
3-Phase

Table PK-7-C — 4WCY4 - XL14c - Convertible Packaged Heat Pump - R-410A

Model Number	Capacity (BTUH)	SEER / EER	HSPF	Shipping Weight	MCA	Max Fuse	Sound Rating	Uncrated Dimensions (in.) H x D x W
4WCY4 – 208-230/3/60								
4WCY4036B3000A	36,000	14.00/11.70	8.00	468	18.4	25	69	38 x 42 x 49
4WCY4048A3000C	47,000	14.00/11.75	8.00	607	25.3	35	73	38 x 45 x 59
4WCY4060A3000C	58,000	14.00/11.50	8.00	623	28.6	45	76	42 x 45 x 59

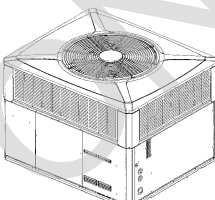

4WCC4
13.4 SEER2
1-Phase

Table PK-7-D — 4WCC4 - XR13.4c (13.4 SEER2) - Convertible Packaged Heat Pump - R-410A

Model Number	Cooling Capacity (BTUH)	Heating Capacity (BTUH)	SEER2 / EER2	HSPF2	Shipping Weight	MCA	Max Fuse	Sound Rating	Uncrated Dimensions (in.) H x D x W
4WCC4 (13.4 SEER2) – 208-230/1/60									
4WCC4024E1000A	23,800	23,200	13.40/11.00	7.0	401	20.6	30	66.4	46 x 45 x 52
4WCC4030E1000A	29,800	28,600	13.40/11.00	7.0	430	22.6	35	70.0	48 x 45 x 52
4WCC4036E1000A	35,200	34,400	13.40/11.00	7.0	439	24.4	40	69.4	48 x 45 x 52
4WCC4042E1000A	43,000	39,000	13.40/11.00	7.0	548	28.3	45	71.5	48 x 45 x 52
4WCC4048E1000A	47,000	45,000	13.40/11.00	7.0	529	31.9	50	72.5	50 x 47 x 62
4WCC4060E1000A	57,000	55,000	13.40/11.00	7.0	594	39.0	60	77.3	52 x 47 x 62

For dimensional/outline drawings, please refer to Product Data.
For information on Roof Curbs, please refer to the Accessories/Information Tab.



Packaged Heat Pump Convertible 2-5 Tons

Table PK-8-A – Features

	4WCZ6 3-5	4WCZ5 2-5	4WCY4 3-5	4WCC4 2-5
• SEER up to.....	16.00	—	14.25	—
• SEER2 up to	—	15.00	—	13.40
• HSPF up to.....	8.20	—	8.00	—
• HSPF2 up to	—	7.45	—	6.70
• Exclusive Climatuff™ high efficiency compressor with internal overload protection	✓	✓	✓	✓
• Factory supplied charge.....	R-410A	R-410A	R-410A	R-410A
• Composite Vortica® indoor blower	✓	✓	✓	✓
• Direct drive, multi-speed ECM blower motor (high efficiency)*	—	—	—	✓
• Direct drive, variable speed ECM indoor blower motor**	✓	✓	✓	—
• All aluminum Spine Fin™ outdoor coil	✓	✓	✓	✓
• Swept-blade outdoor fan for quiet operation	✓	✓	✓	✓
• Architecturally integrated louvers.....	✓	✓	✓	—
• Polyslate gray cabinet.....	✓	✓	✓	✓
• Single stage heating & cooling.....	—	—	✓	✓
• Two stage heating & cooling.....	✓	✓	—	—
• High pressure cutout.....	✓	✓	✓	✓
• Low pressure cutout.....	✓	✓	✓	✓
• Liquid line drier - factory installed.....	✓	✓	✓	✓
• Non-bleed expansion valves on indoor and outdoor coils.....	✓	✓	✓	✓
• Pressure taps, including liquid line taps, easily accessed and protected inside compressor compartment	✓	✓	✓	✓
• Right side electrical service access for high and low voltage connections.....	✓	✓	✓	✓
• Rugged steel basepan features deep drawn duct connections	✓	✓	✓	✓
• Steeply sloped composite drainpan.....	✓	✓	✓	✓
• Ships in horizontal configuration and converts quickly for downflow	✓	✓	✓	✓
• Copper tube, aluminum fin indoor coil	✓	✓	✓	✓
• All models are certified to UL 1995.....	✓	✓	✓	✓
• 10-year compressor, 10-year outdoor coil, & 10-year all other functional parts limited warranty with registration† (Residential use).....	—	—	✓	✓
• 12-year compressor, 10-year outdoor coil, & 10-year all other functional parts limited warranty with registration† (Residential use).....	✓	✓	—	—
• Extended Warranties Available	✓	✓	✓	✓

*Constant torque ECM (electronically commutated motor).

**Constant airflow ECM (electronically commutated motor).

† Registered Limited Warranty terms are available when you register within 60 days of installation. You can register online at Trane.com or by phone at 855-260-2975, otherwise Trane's Base Limited Warranty terms will apply. Base Limited Warranty information on specific products can be found on Trane.com. Ask your dealer for full warranty information at time of purchase. Warranties are for residential and multi-family use only, some exclusions may apply.

**For dimensional/outline drawings, please refer to Product Data.
For information on Roof Curbs, please refer to the Accessories/Information Tab.**

For complete equipment / combination selections, installation instructions and warranty information, please refer to Product Data/Ratings and/or Installers Guides and Limited Warranty Handbooks.

Packaged Heat Pump Convertible 2-5 Tons

Table PK-9-A — Accessories

Model Number	Description	Shipping Weight	4WCZ6	4WCZ5	4WCY4	4WCC4
			2-5	2-5	2-5	2-5
BAYACCDOR1A	Hinged Filter Access Door®		3	2-3	3	2-3
BAYACCDOR2A	Hinged Filter Access Door®		4-5	4-5	4-5	3½-5
BAYACCEADP1A	Adaptor Kit for Installation of CleanEffects™ and 5" Media Filter (Horizontal)®	10	3	2-3	3	2-3
BAYACCEADP2A	Adaptor Kit for Installation of CleanEffects™ and 5" Media Filter (Horizontal)®	12	4-5	4-5	4-5	3½-5
BAYADAP050A	Adapter Curb (Cabinet A/B)		3	2-3	3	2-3
BAYADAP051A	Adapter Curb (Cabinet C)		3	2-3	3	2-3
BAYADAP052A	Adapter Curb (Cabinet A/B)		4-5	4-5	4-5	3½-5
BAYADAP053A	Adapter Curb (Cabinet C)		4-5	4-5	4-5	3½-5
BAYADAP054A	Adapter Curb (Cabinet D)		4-5	4-5	4-5	3½-5
BAYASCT001	Anti-Short Cycle Timer®		✓	✓	✓	✓
BAYCCHT102A	Crankcase Heater (230V) (Scroll)		4-5	4-5	4-5	3½-5
BAYCCHT103A	Crankcase Heater (230V) (Scroll)		3	2-3	3	2-3
BAYCCHT404B	Crankcase Heater (460V) (Scroll)		4-5	4-5	—	—
BAYCCHT405A	Crankcase Heater (460V) (Scroll)		3	3	—	—
BAYCOVR112A	12" Duct Shroud (Covers Horizontal Ducts)®		3-5	2-5	3-5	2-5
BAYCOVR118A	18" Duct Shroud (Covers Horizontal Ducts)®		3-5	2-5	3-5	2-5
BAYCURB050A	Flat Roof Full Perimeter Curb (Insulated)	74	3	2-3	3	2-3
BAYCURB051A	Flat Roof Full Perimeter Curb (Insulated)	74	3	—	4-5	3½-5
BAYDMPR101A	2-Position Motorized Damper② ⑦ ⑧ ⑨ ⑩		4-5	2-3	3	2-3
BAYDMPR102A	2-Position Motorized Damper② ⑦ ⑧ ⑨ ⑩		—	4-5	4-5	3½-5
BAYECON101A	Economizer with Barometric Relief (Downflow)① ② ③ ④ ⑤ ⑥		—	—	2-3	2-3
BAYECON102A	Economizer with Barometric Relief (Downflow)① ② ③ ④ ⑤ ⑥		3	—	4-5	3½-5
BAYECON103A	Economizer with Barometric Relief (Downflow)① ② ③ ④ ⑤ ⑥	50	4-5	2-3	—	—
BAYECON104A	Economizer with Barometric Relief (Downflow)① ② ③ ④ ⑤ ⑥	65	—	4-5	—	—
BAYECON200A	Economizer (Horizontal)① ② ③ ④ ⑦		—	—	2-3	2-3
BAYECON201A	Economizer (Horizontal)① ② ③ ④ ⑦		—	—	4-5	3½-5
BAYENTH001A	Enthalpy Control Kit③	2	✓	✓	✓	✓
BAYEXMK001A	Extreme Conditions Mounting Kit		✓	✓	✓	✓
BAYEXMK002B	Extreme Conditions Mounting Kit		✓	✓	✓	✓
BAYEXMK003A	Extreme Conditions Mounting Kit (Used on Slab Mounts)		✓	✓	✓	✓
BAYFLTR101C	1-2" Filter Frame② -Requires one 18x25 filter (not included)	6	3	2-3	3	2-3
BAYFLTR201C	1-2" Filter Frame② ⑧ -Requires one 18x20, and one 18x18 filter (not included)	6	4-5"	4-5	4-5	3½-5
BAYLIFT002B	Lifting Lug Kit	5	✓	✓	✓	✓
BAYLOAM105A	Low Ambient Control Kit	5	—	—	✓	✓
BAYRLAY004A	Economizer Relay①	1	✓	✓	—	—
BAYRLAY006A	Economizer Relay①	1	4-5	2-5	—	3-5
BAYOSAC001B	Outside Air Control for V.S. Economizer®		3	2-3	3	2-3
BAYOSAH001A	Manual Fresh Air Damper②	6	4-5	4-5	4-5	3½-5
BAYOSAH002A	Manual Fresh Air Damper②	8	✓	✓	✓	✓
BAYQSTK300A	Start Kit (not factory installed)		3	2-3	2-3	2-3
BAYSQRD001B	16" Round Duct Adapter®	5	4-5	4-5	2-5	2-3
BAYSQRD002B	18" Round Duct Adapter®	3	3-4	2-3	2-3	2-5
BAYUTIL101B	Roof Curb Extension Kit		4-5	4-5	4-5	2-3
BAYUTIL102B	Roof Curb Extension Kit		—	—	—	3½-5

- ① Relay required with economizer on all heat pump applications.
- ② Must use filter frame when economizer/fresh air kit is used.
- ③ Dry bulb control standard with economizer.
- ④ 2-Stage cooling control required when using economizer.
- ⑤ It is the responsibility of the installing dealer to properly size the ductwork for each specific application.
- ⑥ BAYCOVR112,118A will not cover BAYSQRD002B applications.
- ⑦ Does not contain barometric relief.
- ⑧ Max fresh air - 25%.
- ⑨ For non-continuous fan gas-heating applications, the damper opens only when the OD ambient is above 50° F.
- ⑩ It is the designer/engineer/installer's responsibility to review product specifications and technical literature to insure optimal performance and compliance to codes.
- ⑪ Temperature of mixed air entering the heat exchanger is monitored and fresh air intake may be reduced under certain conditions.
- ⑫ BAYACCDOR1A requires BAYFLTR101B & BAYACCDOR2A requires BAYFLTR201B. They are not backward compatible to BAYFLTR101/201A.
- ⑬ BAYOASH001/002 is not compatible with BAYACCDOR1A or BAYACCDOR2A
- ⑭ When using a BAYACCDOR2A, two 18x20 filters are required

EXISTING CURB	NEW UNIT 4WC**A	USE BAYADAP**A
BAYCURB030,38A	024-036	50
BAYCURB030,38A	042-060	52
BAYCURB033A	024-036	51
BAYCURB033A	042-060	53
BAYCURB034A	042-060	54

**For dimensional/outline drawings, please refer to Product Data.
For information on Roof Curbs, please refer to the Accessories/Information Tab.**

For complete equipment / combination selections, installation instructions and warranty information, please refer to Product Data/Ratings and/or Installers Guides and Limited Warranty Handbooks.

TRANE®

It's Hard To Stop A Trane.®

Packaged Heat Pump Over/Under 2-3.5 Tons

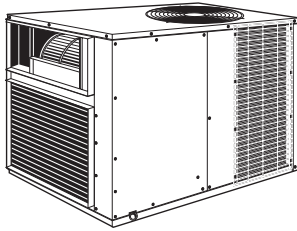
4WHC4
13.4 SEER2
1-Phase

- Climatuff® compressor
- Over (supply) under (return) air
- Compressor internal overload protection
- Solenoid operated switchover valve
- Demand defrost control system
- Multi-speed direct drive blower motor
- High efficiency multi-speed ECM indoor motor.
- Weather resistant Powder Paint
- Copper tube, aluminum plate fin coils
- Top discharge condensing fan
- Factory installed wrap-around coil guard
- Top access to supplementary heat
- Pressure taps for refrigerant checks
- Polarized plug for easy field connection of low voltage to supplementary heaters
- Low ambient cooling to 55°F as manufactured
- Low ambient cooling to 0°F with accessory BAYLOAM011A
- All models are certified to UL 1995
- 10-year registered limited warranty on compressor, outdoor coil and all other functional parts† (Residential Use)
- Optional extended warranties

Table PK-10-A – XR13.4 (13.4 SEER2) – Over/Under Horizontal Packaged Heat Pump – R-410A

Model No.	Cooling Capacity (BTUH)	Heating Capacity (BTUH)	SEER2/EER2	HSPF2	Shipping Weight (lbs)	MCA*	Max Fuse*	Sound Rating	Shipping Dimensions (in.) H X D X W
4WHC4024B1000A	24,200	22,200	13.40/10.60	6.7	322	18.5	25	74.0	36 x 34 x 48
4WHC4030B1000A	29,400	26,600	13.40/10.60	6.7	322	20.9	30	74.0	36 x 34 x 48
4WHC4036B1000A	35,400	33,000	13.40/10.60	6.7	322	26.0	40	75.0	36 x 34 x 48
4WHC4042B1000A	39,000	35,800	13.40/10.60	6.7	353	29.7	45	75.0	36 x 34 x 48
Tons	Supply H x W	Return H x W							
2 – 3½	8¾ x 27¾	16¾ x 27¾							

Dimensions are in inches. See Outline Dimensions.

* Information subject to change. Please confirm with current Product Data/Service Facts for current factory production. Compressor Types are: R1 = Reciprocating One Cylinder, R2 = Reciprocating Two Cylinder, S = Scroll

Table PK-10-B – Supplementary Heaters – Heater Matrix

Model No.①	Power Supply	kW Ratings	Used With	Shipping Weight
BAYHTRC106A	208/240/1/60	4.33/5.76 kW	4WHC4024-42	9
BAYHTRC109A	208/240/1/60	6.12/8.16 kW	4WHC4036-42	10
BAYHTRC111A	208/240/1/60	7.98/10.56 kW	4WHC4024-42	10
BAYHTRC117A	208/240/1/60	12.98/17.28 kW	4WHC4030-42	23

Table PK-10-C – Accessories/Comfort Controls

Model No.	Description	Used With	Shipping Weight
BAYASCT00① ② ③	Anti-Short Cycle Timer	All 4WHC4 Models	1
BAYECMT003A	Extreme Conditions Mounting Kit (Slab or Rack Mount)	All 4WHC4 Models	2
BAYLOAM011A	Low Ambient Cooling Kit	All 4WHC4 Models	5
TAYASCT501A③	5 Minute Delay Relay	All 4WHC4 Models	2
TCONT402A	3Heat/2Clg (Heat Pump/A/C)	All 4WHC4 Models	1
TCONT602A	2Heat/2Clg (Heat Pump/A/C)	All 4WHC4 Models	1
TCONT802A	3Heat/2Clg (Heat Pump/A/C)	All 4WHC4 Models	1
TCONT803A	3Heat/2Clg (Heat Pump/A/C) w/Humidity Display	All 4WHC4 Models	1

① Heaters must have an "A" in eleventh digit to work on 4WHC4 models.

② Not for use with electronic thermostats.

③ Activated on Power Off.

† Registered Limited Warranty terms are available when you register within 60 days of installation. You can register online at Trane.com or by phone at 855-260-2975, otherwise Trane's Base Limited Warranty terms will apply. Base Limited Warranty information on specific products can be found on Trane.com. Ask your dealer for full warranty information at time of purchase. Warranties are for residential and multi-family use only, some exclusions may apply.

For dimensional/outline drawings, please refer to Product Data.
For information on Roof Curbs, please refer to the Accessories/Information Tab.

For complete equipment / combination selections, installation instructions and warranty information, please refer to Product Data/Ratings and/or Installers Guides and Limited Warranty Handbooks.

Packaged Gas/Electric Convertible 2-5 Tons

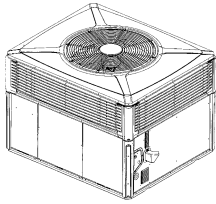

4YCZ6
16.0 SEER
3-Phase

Table PK-11-A — 4YCZ6 - XL16c - Convertible Packaged Gas/Electric - R-410A

Model Number	Cooling Capacity (BTUH)	Heating Capacity Output (1 Stg./2 Stg.)	SEER	EER High/Low	AFUE (%)	Shipping Weight	MCA	Max Fuse	Sound Rating	Uncrated Dimensions (in.) H x D x W
4YCZ6 – 208-230/1/60										
4YCZ6036A3075C	35,600	45,000/60,000	16.60	12.00/13.60	80.0	488	19.7	30	70	38 x 42 x 49
4YCZ6036A3096C	35,600	57,600/77,000	16.60	12.00/13.60	80.0	493	19.7	30	70	38 x 42 x 49
4YCZ6048A3096C	48,000	57,600/77,000	16.00	12.00/13.48	80.0	659	25.2	35	71	42 x 45 x 59
4YCZ6048A3120C	48,000	72,000/96,000	16.00	12.00/13.48	80.0	665	25.2	35	71	42 x 45 x 59
4YCZ6060A3120C	57,500	72,000/96,000	15.10	11.40/12.65	80.0	676	28.6	40	73	42 x 45 x 59
4YCZ6 – 460/3/60										
4YCZ6036A4075D	35,600	45,000/60,000	16.60	12.00/13.60	79.0	488	11.9	15	70	38 x 42 x 49
4YCZ6036A4096D	35,600	57,600/77,000	16.60	12.00/13.60	80.0	493	11.9	15	70	38 x 42 x 49
4YCZ6048A4096D	48,000	57,600/77,000	16.00	12.00/13.48	80.0	659	15.3	20	71	42 x 45 x 59
4YCZ6048A4120D	48,000	72,000/96,000	16.00	12.00/13.48	80.0	665	15.3	20	71	42 x 45 x 59
4YCZ6060A4120D	57,500	72,000/96,000	15.10	11.40/12.65	80.0	676	17.2	20	73	42 x 45 x 59

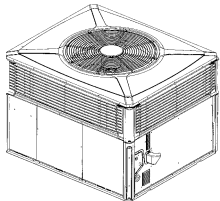

4YCZ5
15.0 SEER2
1-Phase

Table PK-11-B — 4YCZ5 - XL15c - Convertible Packaged Gas/Electric - R-410A

Model Number	Cooling Capacity (BTUH)	Gas Capacity Heating Output	SEER2/EER2	AFUE (%)	Shipping Weight	MCA	Max Fuse	Sound Rating	Shipping Dimensions (in.) H x D x W
4YCZ5 – 208-230/1/60									
4YCZ5024E1060	24,000	60,000	15.00/11.00	81.0	440	19.5	30	65.4	36 x 44 x 51
4YCZ5030E1**	IN DEVELOPMENT PLANNED LAUNCH Q1 2023								
4YCZ5036E1070	35,200	70,000	15.00/11.00	81.0	493	24.2	35	70.0	38 x 44 x 51
4YCZ5036E1090	35,200	90,000	15.00/11.00	81.0	498	24.2	35	70.0	38 x 44 x 51
4YCZ5042E1**	IN DEVELOPMENT PLANNED LAUNCH Q1 2023								
4YCZ5048E1090	47,500	90,000	15.00/11.00	81.0	659	34.1	50	71.0	42 x 44 x 51
4YCZ5048E1115	47,500	115,000	15.00/11.00	81.0	665	34.1	50	71.0	42 x 44 x 51
4YCZ5060E1060	57,500	60,000	15.00/10.90	81.0	676	38.0	60	73.0	42 x 44 x 51

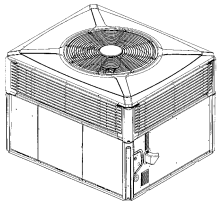

4YCY4
14.0 SEER
3-Phase

Table PK-11-C — 4YCY4 - XL14c - Convertible Packaged Gas/Electric - R-410A

Model Number	Cooling Capacity (BTUH)	Heating Capacity Input/Output	SEER/EER	AFUE (%)	Shipping Weight	MCA	Max Fuse	Sound Rating	Uncrated Dimensions (in.) H x D x W
4YCY4 – 208-230/3/60									
4YCY4036B3075A	38,000	45,000/60,000	14.30/12.00	80.0	488	18.5	25	69	38 x 42 x 49
4YCY4036B3096A	38,000	57,600/77,000	14.20/12.00	80.0	493	18.5	25	69	38 x 42 x 49
4YCY4048B3096A	48,000	57,600/77,000	14.20/12.00	80.0	653	25.3	35	73	38 x 45 x 59
4YCY4048B3120A	48,000	72,000/96,000	14.20/11.90	80.0	659	25.3	35	73	38 x 45 x 59
4YCY4060A3120B	58,500	72,000/96,000	14.30/12.00	80.0	676	28.6	40	76	42 x 45 x 59

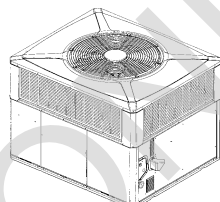

4YCC4
13.4 SEER2
1-Phase

Table PK-11-D — 4YCC4 - XR13.4c (13.4 SEER2) - Convertible Packaged Gas/Electric - R-410A

Model Number	Cooling Capacity (BTUH)	Gas Heating Capacity Input/Output	SEER2/EER2	AFUE (%)	Shipping Weight	MCA	Max Fuse	Sound Rating	Shipping Dimensions (in.) H x D x W
4YCC4 – 208-230/1/60									
4YCC4024E1060	23,200	60,000	13.40/11.00	81.0	432	16.7	25	66.6	46 x 45 x 52
4YCC4030E1070	28,000	70,000	13.40/11.00	81.0	451	20.8	30	70.0	48 x 45 x 52
4YCC4036E1070	36,400	70,000	13.40/11.00	81.0	438	26.2	40	69.3	48 x 45 x 52
4YCC4036E1090	36,400	90,000	13.40/11.00	81.0	453	26.2	40	69.3	48 x 45 x 52
4YCC4042E1060	39,500	60,000	13.40/11.00	81.0	555	28.3	45	74.6	46 x 47 x 62
4YCC4042E1090	39,500	90,000	13.40/11.00	81.0	561	28.3	45	74.6	46 x 47 x 62
4YCC4048E1070	46,000	70,000	13.40/11.00	81.0	552	31.8	50	72.5	50 x 47 x 62
4YCC4048E1090	46,000	90,000	13.40/11.00	81.0	557	31.8	50	72.5	50 x 47 x 62
4YCC4060E1090	57,000	90,000	13.40/11.00	81.0	580	39.1	60	73.1	50 x 47 x 62
4YCC4060E1115	57,000	115,000	13.40/11.00	81.0	586	39.1	60	73.1	50 x 47 x 62

For dimensional/outline drawings, please refer to Product Data.

For information on Roof Curbs, please refer to the Accessories/Information Tab.

For complete equipment / combination selections, installation instructions and warranty information, please refer to Product Data/Ratings and/or Installers Guides and Limited Warranty Handbooks.



It's Hard To Stop A Trane.®

Packaged Gas/Electric Convertible 2-5 Tons

Table PK-12-A — Features

	4YCZ6 2-5	4YCY5 2-5	4YCY4 2-5	4YCC4 2-5
• SEER up to.....	16.60	—	14.30	—
• SEER2 up to.....	—	15.25	—	14.00
• Exclusive Climatuff™ high efficiency compressor with internal overload protection	✓	✓	✓	✓
• Factory supplied charge	R-410A	R-410A	R-410A	R-410A
• Composite Vortica® indoor blower.....	✓	✓	✓	✓
• Direct drive, variable speed ECM blower motor**	✓	✓	✓	✓
• All aluminum Spine Fin™ outdoor coil.....	✓	✓	✓	✓
• Swept-blade outdoor fan for quiet operation	✓	✓	✓	✓
• Architecturally integrated louvers and corner guards.....	✓	✓	✓	✓
• Polyslate gray cabinet.....	✓	✓	✓	✓
• Stainless steel heat exchanger and burners.....	✓	✓	✓	✓
• Single stage cool.....	—	—	✓	✓
• Single stage gas	—	—	—	✓
• 2-stage cooling.....	✓	✓	—	—
• 2-stage gas	✓	✓	✓	—
• High pressure cutout.....	✓	✓	✓	✓
• Low pressure cutout.....	✓	✓	✓	✓
• Liquid line drier - factory installed	✓	✓	✓	✓
• Non-bleed expansion valves on indoor coil.....	✓	✓	✓	✓
• Pressure taps, including liquid line taps, easily accessed and protected inside compressor compartment	✓	✓	✓	✓
• Right side electrical service access for high and low voltage connections	✓	✓	✓	✓
• Rugged steel basepan features deep drawn duct connections.....	✓	✓	✓	✓
• Steeply sloped composite drainpan	✓	✓	✓	✓
• Ships in horizontal configuration and converts quickly for downflow	✓	✓	✓	✓
• Copper tube, aluminum fin indoor coil.....	2	2	✓	2-4
• All aluminum indoor coil.....	✓	✓	✓	—
• All models are certified to ANSI Z21.47/CSA 2.3.....	✓	✓	—	—
• 20-year heat exchanger, 12-year compressor, 10-year coils, & 10-year all other functional parts limited warranty with registration† (Residential use).....	—	—	✓	✓
• 20-year heat exchanger, 10-year compressor, 10-year coils, & 10-year all other functional parts limited warranty with registration† (Residential use).....	✓	✓	—	—
• Extended warranties available	✓	✓	✓	✓

**Constant airflow ECM (electronically commutated motor).

† Registered Limited Warranty terms are available when you register within 60 days of installation. You can register online at Trane.com or by phone at 855-260-2975, otherwise Trane's Base Limited Warranty terms will apply. Base Limited Warranty information on specific products can be found on Trane.com. Ask your dealer for full warranty information at time of purchase. Warranties are for residential and multi-family use only, some exclusions may apply.

For dimensional/outline drawings, please refer to Product Data.
 For information on Roof Curbs, please refer to the Accessories/Information Tab.

For complete equipment / combination selections, installation instructions and warranty information, please refer to Product Data/Ratings and/or Installers Guides and Limited Warranty Handbooks.



Packaged Gas/Electric Convertible 2-5 Tons

Table PK-13-A – Accessories

Model Number	Description	Shipping Weight	4YCZ6 3-5	4YCZ5 2-5	4CY4 3-5	4GCC4 2-5
BAYACCDOR1A.....	Hinged Filter Access Door®		3	2-3	3	2-3
BAYACCDOR2A.....	Hinged Filter Access Door®		4-5	4-5	4-5	3½-5
BAYACCEADP1A.....	Adaptor Kit for Installation of CleanEffects™ and 5" Media Filter (Horizontal)®	10	3	2-3	3	2-3
BAYACCEADP2A.....	Adaptor Kit for Installation of CleanEffects™ and 5" Media Filter (Horizontal)®	12	4-5	4-5	4-5	3½-5
BAYADAP050A.....	Adapter Curb (Cabinet A/B)		3	2-3	3	2-3
BAYADAP051A.....	Adapter Curb (Cabinet C)		3	2-3	3	2-3
BAYADAP052A.....	Adapter Curb (Cabinet A/B)		4-5	4-5	4-5	3½-5
BAYADAP053A.....	Adapter Curb (Cabinet C)		4-5	4-5	4-5	3½-5
BAYADAP054A.....	Adapter Curb (Cabinet D)		4-5	4-5	4-5	3½-5
BAYASCT001.....	Anti-Short Cycle Timer③.....		✓	✓	✓	✓
BAYCCHT102A.....	Crankcase Heater (230v) (Scroll)		—	—	—	3½-5
BAYCCHT103A.....	Crankcase Heater (230V) (Scroll)		3	2-3	3	2-3
BAYCCHT404B.....	Crankcase Heater (460v) (Scroll)		4-5	4-5	—	—
BAYCCHT405A.....	Crankcase Heater (460v) (Scroll)		3	3	—	—
BAYCOVR112A.....	12" Duct Shroud (Covers Horizontal Ducts)®.....		3-5	2-5	3-5	2-5
BAYCOVR118A.....	18" Duct Shroud (Covers Horizontal Ducts)®.....		3-5	2-5	3-5	2-5
BAYCURB050A.....	Flat Roof Full Perimeter Curb (Insulated)	74	3	3	3	2-3
BAYCURB051A.....	Flat Roof Full Perimeter Curb (Insulated)	74	4-5	4-5	4-5	3½-5
BAYDMPR101A.....	Motorized Fresh Air Damper① ⑦ ⑧ ⑨ ⑩.....		3	2-3	3	2-3
BAYDMPR102A.....	Motorized Fresh Air Damper① ⑦ ⑧ ⑨ ⑩.....		4-5	4-5	4-5	3½-5
BAYECON101A.....	Economizer with Barometric Relief (Downflow)① ② ③ ④ ⑤.....	50	—	—	3	2-3
BAYECON102A.....	Economizer with Barometric Relief (Downflow)① ② ③ ④ ⑤.....	65	—	—	4-5	3½-5
BAYECON103A.....	Economizer with Barometric Relief (Downflow)① ② ③ ④ ⑤.....		3	2-3	—	—
BAYECON104A.....	Economizer with Barometric Relief (Downflow)① ② ③ ④ ⑤.....		4-5	4-5	—	—
BAYECON200A.....	Economizer (Horizontal)① ② ③ ④.....	85	—	—	3	2-3
BAYECON201A.....	Economizer (Horizontal)① ② ③ ④.....	85	—	—	4-5	3½-5
BAYECON203A.....	Economizer (Horizontal)① ② ③ ④.....		3	2-3	—	—
BAYECON204A.....	Economizer (Horizontal)① ② ③ ④.....		4-5	4-5	—	—
BAYENTH001A.....	Enthalpy Control Kit②.....	2	✓	✓	✓	✓
BAYEXMK001A.....	Extreme Conditions Mounting Kit (Used on BAYCURB & BAYADAP)		✓	✓	✓	✓
BAYEXMK002B.....	Extreme Conditions Mounting Kit (Used on BAYUTIL)		✓	✓	✓	✓
BAYEXMK003A.....	Extreme Conditions Mounting Kit (Used on Slab Mounts)		✓	✓	✓	✓
BAYFLTR101C.....	1-2" Filter Frame1 -Requires one 18x25 filter (not included).....	6	3	2-3	3	2-3
BAYFLTR201C.....	1-2" Filter Frame1 r -Requires one 18x20, and one 18x18 filter (not inc)	6	4-5	4-5	4-5	3½-5
BAYLIFT002B.....	Lifting Lug Kit.....	5	✓	✓	✓	✓
BAYLOAM105A.....	Low Ambient Control Kit.....	5	✓	✓	✓	✓
BAYLPKT100A.....	LP Conversion Kit		115K	115K	115K	115K
BAYLPKT101A.....	LP Conversion Kit		60K,90K	60K, 90K	60K,90K	60K, 90K
BAYLPKT102A.....	LP Conversion Kit		70K	70K	70K	70K
BAYOSAC001B.....	Outside Air Control for V.S. Economizere		3-5	3,4,5	—	—
BAYOSAH001A.....	Manual Fresh Air Damper①.....	6	3	2-3	3	2-3
BAYOSAH002A.....	Manual Fresh Air Damper①.....	8	4-5	4-5	4-5	3½-5
BAYQSTK301A.....	Start Kit (not factory installed).....		✓	✓	—	✓
BAYSQRD001B.....	16" Round Duct Adapter®	5	3-5	2-3	3-5	2-3
BAYSQRD002B.....	18" Round Duct Adapter®	3	3-5	4-5	3-5	2-5
BAYUTIL101B.....	Roof Curb Utility Extension Kit.....		3	2-3	3	2-3
BAYUTIL102B.....	Roof Curb Utility Extension Kit.....		4-5	4-5	4-5	3½-5

- ① Must use filter frame when economizer/fresh air kit is used.
- ② Dry bulb control standard with economizer.
- ③ 2-Stage cooling control required when using economizer.
- ④ Do not use with electronic thermostats.
- ⑤ It is the responsibility of the installing dealer to properly size the ductwork for each specific application.
- ⑥ BAYCOVR112,118A will not cover BAYSQRD002B applications.
- ⑦ Does not contain barometric relief.
- ⑧ Max fresh air - 25%.
- ⑨ For non-continuous fan gas-heating applications, the damper opens only when the OD ambient is above 50° F.
- ⑩ It is the designer/engineer/installer's responsibility to review product specifications and technical literature to insure optimal performance and compliance to codes.
- ⑪ Temperature of mixed air entering the heat exchanger is monitored and fresh air intake may be reduced under certain conditions.
- ⑫ BAYACCDOR1A requires BAYFLTR101B & BAYACCDOR2A requires BAYFLTR201B. They are not backward compatible to BAYFLTR101/201A.
- ⑬ BAYOASH001/002 is not compatible with BAYACCDOR1A or BAYACCDOR2A
- ⑭ When using a BAYACCDOR2A, two 18x20 filters are required

EXISTING CURB	NEW UNIT 4YC**A	USE BAYADAP0**A
BAYCURB030,38A	024-036	50
BAYCURB030,38A	042-060	52
BAYCURB033A	024-036	51
BAYCURB033A	042-060	53
BAYCURB034A	042-060	54

**For dimensional/outline drawings, please refer to Product Data.
For information on Roof Curbs, please refer to the Accessories/Information Tab.**

For complete equipment / combination selections, installation instructions and warranty information, please refer to Product Data/Ratings and/or Installers Guides and Limited Warranty Handbooks.



It's Hard To Stop A Trane.®

Single Power Entry Kits Packaged Convertible 2-5 Tons

	SINGLE POWER ENTRY KIT	HEATER	4TCC4	4WCC4	4WCZ6
1-Phase (208-230v)	BAYSPEK060	BAYHTRV105	2-5	2-3.5	2-3
		BAYHTRV108	2-5	—	—
		BAYHTRV110	2-4	—	—
	BAYSPEK062	BAYHTRV105	—	4-5	4-5
		BAYHTRV108	—	2-5	2-5
		BAYHTRV110	5	2-5	2-5
	BAYSPEK063	BAYHTRV115	2.5-5	2.5-5	3-5
		BAYHTRV120	4-5	3.5-5	4-5

	SINGLE POWER ENTRY KIT	HEATER	4WCY4	4WCZ5*	4WCZ6
3-Phase (208-230v)	BAYSPEK064	BAYHTRV315	3-5	3-5	3-5
		BAYHTRV320	4-5	4-5	4-5
	BAYSPEK065	BAYHTRV310	5	5	5
	BAYSPEK061	BAYHTRV305	3-5	3-5	3-5
		BAYHTRV308	3-5	3-5	3-5
		BAYHTRV310	3-4	3-4	3-4
		BAYHTRV315	—	—	—
	BAYSPEK061	BAYHTRV405	—	3-5	3-5
		BAYHTRV408	—	3-5	3-5
		BAYHTRV410	—	3-5	3-5
		BAYHTRV415	—	3-5	3-5
		BAYHTRV420	—	4-5	4-5

* 15 SEER2 launching in January 2023

For dimensional/outline drawings, please refer to Product Data.

For information on Roof Curbs, please refer to the Accessories/Information Tab.

For complete equipment / combination selections, installation instructions and warranty information, please refer to Product Data/Ratings and/or Installers Guides and Limited Warranty Handbooks.



It's Hard To Stop A Trane.®

Supplemental Heater Table Packaged Convertible 2-5 Tons

1-PHASE (208-230v) Model Number	BAYHTRV105 3.76/5.0 kW	BAYHTRV108 6.0/8.0 kW	BAYHTRV110 7.50/10.0 kW	BAYHTRV115 11.27/15.0 kW	BAYHTRV120 15.00/20.0 kW	BAYHTRV125 18.78/25.0 kW
4TCC4024E1	Y	Y	Y	-	-	-
4TCC4030E1	Y	Y	Y	Y	-	-
4TCC4036E1	Y	Y	Y	Y	-	-
4TCC4042E1	Y	Y	Y	Y	Y	Y
4TCC4048E1	Y	Y	Y	Y	Y	Y
4TCC4060E1	Y	Y	Y	Y	Y	Y
4WCC4024E1	Y	Y	Y	-	-	-
4WCC4030E1	Y	Y	Y	Y	-	-
4WCC4036E1	Y	Y	Y	Y	-	-
4WCC4042E1	Y	Y	Y	Y	-	-
4WCC4048E1	Y	Y	Y	Y	Y	-
4WCC4060E1	Y	Y	Y	Y	Y	Y
4WCZ5024E1	Y	Y	Y	-	-	-
4WCZ5030E1	IN DEVELOPMENT: Available January 2023					
4WCZ5036E1	Y	Y	Y	Y	-	-
4WCZ5042E1	IN DEVELOPMENT: Available January 2023					
4WCZ5048E1	Y	Y	Y	Y	Y	-
4WCZ5060E1	Y	Y	Y	Y	Y	Y

Note: 4WCZ5030A1* and 4WCZ5042A1 in development for a Q1 2023 launch

3-PHASE (208-230v) Model Number	BAYHTRV305 3.76/5.0 kW	BAYHTRV308 6.0/8.0 kW	BAYHTRV310 7.50/10.0 kW	BAYHTRV315 11.27/15.0 kW	BAYHTRV320 15.00/20.0 kW	BAYHTRV325 18.78/25.0 kW
4WCY4036A3	Y	Y	Y	Y	-	-
4WCY4048A3	Y	Y	Y	Y	Y	Y
4WCY4060B3	Y	Y	Y	Y	Y	Y
4WCZ5036E3	IN DEVELOPMENT: Available January 2023					
4WCZ5048E3	IN DEVELOPMENT: Available January 2023					
4WCZ5060E3	IN DEVELOPMENT: Available January 2023					
4WCZ6036B3	Y	Y	Y	Y	-	-
4WCZ6048B3	Y	Y	Y	Y	Y	Y
4WCZ6060B3	Y	Y	Y	Y	Y	Y

Note: 4WCZ50***3 family in development for a Q1 2023 launch

3-PHASE (460v) Model Number	BAYHTRV405 3.76/5.0 kW	BAYHTRV408 6.0/8.0 kW	BAYHTRV410 7.50/10.0 kW	BAYHTRV415 11.27/15.0 kW	BAYHTRV420 15.00/20.0 kW	BAYHTRV425 18.78/25.0 kW
4WCZ5036E4	IN DEVELOPMENT: Available January 2023					
4WCZ5048E4	IN DEVELOPMENT: Available January 2023					
4WCZ5060E4	IN DEVELOPMENT: Available January 2023					
4WCZ6036B4	Y	Y	Y	Y	-	-
4WCZ6048B4	Y	Y	Y	Y	Y	Y
4WCZ6060B4	Y	Y	Y	Y	Y	Y

Note: 4WCZ50***4 family in development for a Q1 2023 launch

**For dimensional/outline drawings, please refer to Product Data.
For information on Roof Curbs, please refer to the Accessories/Information Tab.**

For complete equipment / combination selections, installation instructions and warranty information, please refer to Product Data/Ratings and/or Installers Guides and Limited Warranty Handbooks.

Roof Curbs

BAYCURB050A FULL PERIMETER ROOF MOUNTING CURB OUTLINE

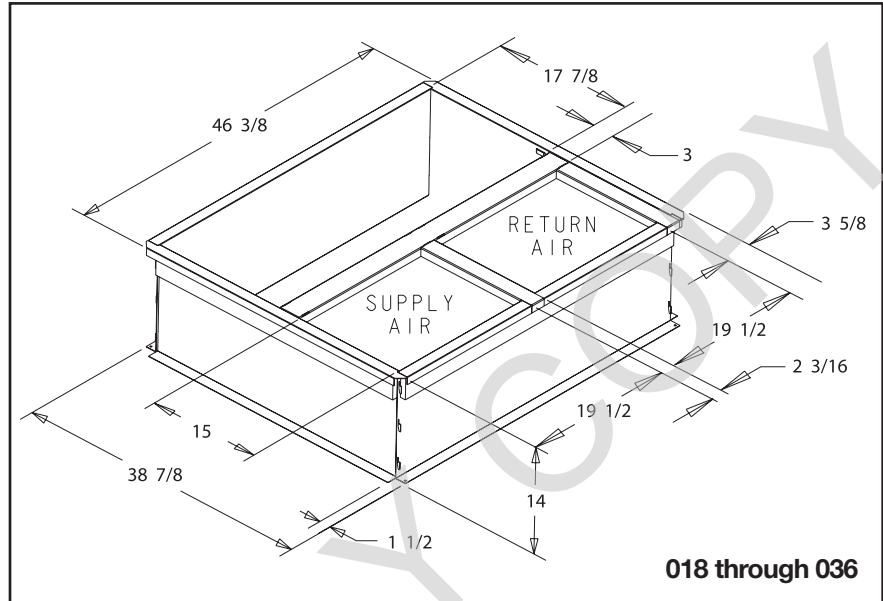

Full Perimeter BAYCURB050A	Full Perimeter BAYCURB051A
4TCY4024-036	4TCY4042-060
4TCX3018-036/4TCC3018-036	4TCX3042-060/4TCC3042-060
4WCZ6036/4DCZ6036	4WCZ6048-060/4DCZ6048-060
4WCY4024-036/4DCY4024-036	4WCY4042-060/4DCY4042-060
2/4WCX3018-036/2/4WCC3018-036	2/4WCX3042-060/2/4WCC3042-060
4YCZ6036	4YCZ6048-060
4YCY4024-036	4YCY4042-060
2/4YCX3018-036/2/4YCC3018-036	2/4YCX3042-060/2/4YCC3042-060

BAYCURB051A FULL PERIMETER ROOF MOUNTING CURB OUTLINE

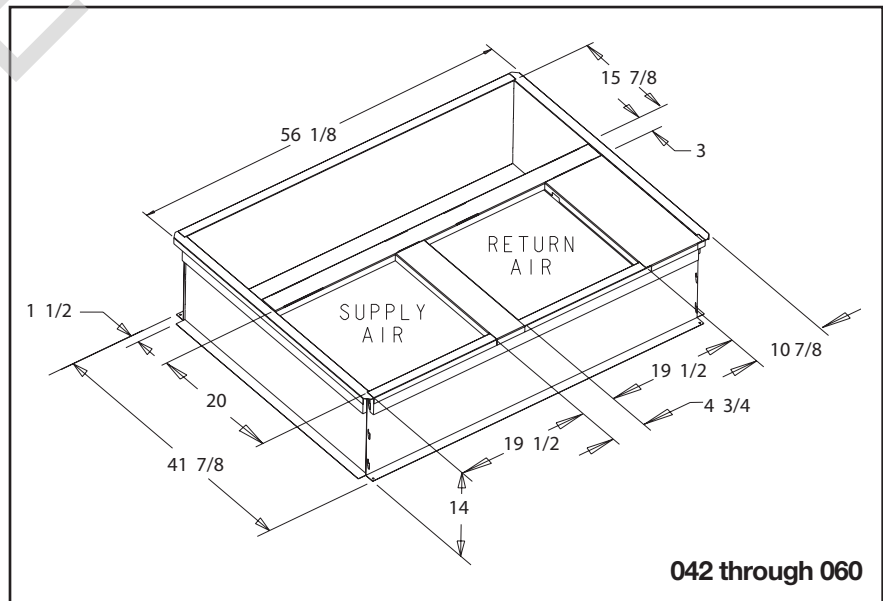



It's Hard To Stop A Trane.®

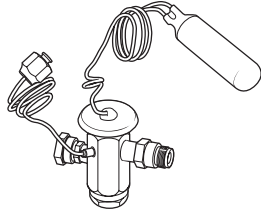

Expansion Valve TXV Cooling/Heat Pump Kit

General Information

This Thermostatic Expansion Valve Kit may be used on any indoor air handler or coil that is equipped with a current thermostatic expansion valve with an internal check valve and mechanical fittings. This kit can be used on split system heat pumps and air conditioning systems.

Thermostatic Expansion Valve Kits can be field installed to fit a variety of sizes and combinations of air handlers or coils and outdoor units to optimize performance.

This TXV kit will normally be used when a different refrigerant is going to be used in the air handler or coil than what is indicated on the unit name plate. The TXV type must always match the refrigerant type used in the outdoor unit.

Kit Identification

The first character in the kit model number indicates the type of refrigerant that the valve can be used with. Example a 2AYTXVH3D1830A is an R-22 valve.

The "3" in the eighth digit in the model number identifies the valve as a non-bleed TXV. When this TXV kit is installed with an outdoor unit that contains a reciprocating compressor, the outdoor unit must be equipped with a hard start kit if not factory installed. If the outdoor unit contains a scroll compressor, the installation of a hard start kit may be required.

Inspection

Check carefully for any shipping damage. Any such damage must be reported and claims made against the transportation company immediately. Any missing parts should be reported to your supplier at once and replaced with authorized parts only.

Thermal Expansion Valves

Table AC/IN-2-A Cooling/Heat Pump Non-Bleed TXV Kits- Dual Direction Flow-TXA/C-BC Coils

R-410 Model Number	R-22 Model Numbers	Used With 13 SEER Coils
4AYTXVH3D1831A	2AYTXVH3C1818A	2/4TXC, TXA018
4AYTXVH3D1831A	2AYTXVH3C2425A	2/4TXC, TXA024,025
4AYTXVH3D1831A	2AYTXVH3C3031A	2/4TXC, TXA031
4AYTXVH3D3343A	—	4TXC, 4TXA-032
4AYTXVH3D3343A	2AYTXVH3C3337A	2/4TXC, TXA036,037
4AYTXVH3D3343A	2AYTXVH3C4243A	2/4TXC, TXA042,043
4AYTXVH3D4863A	—	4TXC, 4TXA-044
4AYTXVH3D4863A	2AYTXVH3C4850A	2/4TXC, TXA048,049,050
4AYTXVH3D4863A	2AYTXVH3C5463A	2/4TXC, TXA060,061,064

Table AC/IN-2-B Cooling/Heat Pump Non-Bleed TXV Kits- Dual Direction Flow

R-410 Model Number	R-22 Model Numbers	Used With Horizontal Flat Coils
4AYTXVH3D1831A	2AYTXVH3C1818A	2/4TXF-018
4AYTXVH3D3343A	2AYTXVH3C3337A	2/4TXF-033
4AYTXVH3D3343A	2AYTXVH3C4243A	2/4TXF-041
4AYTXVH3D4863A	2AYTXVH3C5463A	2/4TXF-054
4AYTXVH3D4863A	2AYTXVH3C5463A	2/4TXF-063

Table AC/IN-2-C Cooling/Heat Pump Non-Bleed TXV Kits- Dual Direction Flow-TXA/C-AS Coils

R-410 Model Number	R-22 Model Numbers	Used With Aluminum Coils
4AYTXVH3B2531A	2AYTXVH3B2531A	2/4TXA, TXC-025
4AYTXVH3B2531A	2AYTXVH3B2531A	2/4TXA, TXC-031
4AYTXVH3B3654A	2AYTXVH3B3637A	2/4TXA, TXC-036
4AYTXVH3B3654A	2AYTXVH3B3637A	2/4TXA, TXC-037
4AYTXVH3B3654A	2AYTXVH3B5454A	2/4TXA, TXC-054
4AYTXVH3B6165A	2AYTXVH3B6565A	2/4TXA, TXC-065

Table AC/IN-2-D Cooling/Heat Pump Non-Bleed TXV Kits – Dual Direction Flow 4NXA/4NXC

R-22 Model Number	Used With 4NXA & 4NXC Coils
2AYTXVH3E1824AA	4NXA, NXC – 018 - 024
2AYTXVH3E2536AA	4NXA, NXC – 025 - 036
2AYTXVH3E6363AA	4NXC - 063

Table AC/IN-2-A Cooling/Heat Pump Non-Bleed TXV Kits- Dual Direction Flow-TXA/C-BC Coils

R-410 Model Number	R-22 Model Numbers	Used With Air Handlers
4AYTXVH3D1830A	2AYTXVH3D1830A	2TFB-018-030
4AYTXVH3D1831A	2AYTXVH3D1830A	2TFB-036
4AYTXVH3D1831A	2AYTXVH3D1830A	2/4TFE-025
4AYTXVH3D1831A	2AYTXVH3D1830A	2/4TEC-018-030
—	2AYTXVH3D3636A	2/4TEC-036
4AYTXVH3D3642A	—	2/4TEC-036-042
—	2AYTXVH3D4260A	2/4TEC-042-060
4AYTXVH3D4863A	—	2/4TEC-048-060
4AYTXVH3D1831A	2AYTXVH3D1830A	2/4TEH-018-030
—	2AYTXVH3D3636A	4TEH-036
4AYTXVH3D3642A	—	2TEH-036-042
—	2AYTXVH3D4260A	4TEH-042-060
4AYTXVH3D4863A	—	2TEH-048-060
4AYTXVH3D1800A	2AYTXVH3D1830A	2/4TGB-018
4AYTXVH3D1830A	2AYTXVH3D1830A	2/4TGB-025
4AYTXVH3D1831A	2AYTXVH3D1830A	2/4TGB-030
4AYTXVH3D3600A	2AYTXVH3D1830A	2/4TGB-036
4AYTXVH3D3343A	2AYTXVH3D4260A	2/4TGB-042
4AYTXVH3D4863A	2AYTXVH3D4260A	2/4TGB-048
4AYTXVH3D3642A	2AYTXVH3D4260A	2/4TEE-039
4AYTXVH3D4863A	2AYTXVH3D4260A	2/4TEE-048-064

For complete equipment / combination selections, installation instructions and warranty information, please refer to Product Data/Ratings and/or Installers Guides and Limited Warranty Handbooks.



It's Hard To Stop A Trane.®

Thermal Expansion Valves

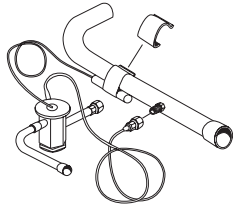

Expansion Valve TXV Cooling Kit

Table AC/IN-3-A – Cooling Bleed TXV Kits – Single Direction Flow

Model Number	Used With AC Units	Liquid Line Connection Dia. I.D. (In.)	Gas Line Connection Dia. I.D. (In.)	Shipping Weight (lbs.)	Refrigerant
TAYTXVA0B5C	1-1½ Ton	1/4	5/8	2	R-22
TAYTXVA0C5C	2-2½ Ton	5/16	3/4	2	R-22
TAYTXVA0E5C	3-3½ Ton	3/8	7/8	2	R-22
TAYTXVA0G5C	4 Ton	3/8	11/8	2	R-22
TAYTXVA0H5C	5-6 Ton	3/8	11/8	2	R-22

Table AC/IN-3-B – Cooling Non-Bleed TXV Kits – Single Direction Flow

Model Number	Used With AC Units	Liquid Line Connection Dia. I.D. (In.)	Gas Line Connection Dia. I.D. (In.)	Shipping Weight (lbs.)	Refrigerant
TAYTXVA0B3C	1-1½ Ton	1/4	5/8	2	R-22
TAYTXVA0C3C	2-2½ Ton	5/16	3/4	2	R-22
TAYTXVA0E3C	3-3½ Ton	3/8	7/8	2	R-22
TAYTXVA0G3C	4 Ton	3/8	11/8	2	R-22
TAYTXVA0H3C	5-6 Ton	3/8	11/8	2	R-22

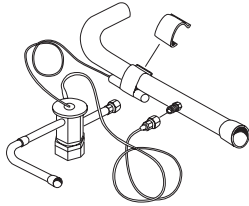

Expansion Valve TXV Heat Pump Kit*

Table AC/IN-3-C – Heat Pump Non- Bleed TXV Kits (also for cooling) – Dual Direction Flow

Model Number	Used With AC Units	Liquid Line Connection Dia. I.D. (In.)	Gas Line Connection Dia. I.D. (In.)	Shipping Weight (lbs.)	Refrigerant
TAYTXVH0B3C	1-1½ Ton	1/4	5/8	3	R-22
TAYTXVH0C3C	2-2½ Ton	5/16	3/4	3	R-22
TAYTXVH0E3C	3-3½ Ton	3/8	7/8	3	R-22
TAYTXVH0G3C	4 Ton	3/8	11/8	3	R-22
TAYTXVH0H3C	5-6 Ton	3/8	11/8	3	R-22

Table AC/IN-3-D – Cooling/Heat Pump Non-Bleed TXV Kits - Dual Direction Flow*

Model Number	Used With AC Units	Liquid Line Connection Dia. I.D. (In.)	Gas Line Connection Dia. I.D. (In.)	Shipping Weight (lbs.)	Refrigerant
AYTXVH0D3C	2½ -3 Ton	3/8	11/8	2	R-22
TAYTXVH0G3C	4-5 Ton	3/8	11/8	2	R-22

Table AC/IN-3-E – R-410A Heat Pump Non-Bleed TXV Kits (also for cooling) - Dual direction flow

Model Number	Used With HP/AC Units	Liquid Line Connection Dia. I.D. (In.)	Gas Line Connection Dia. I.D. (In.)	Shipping Weight (lbs.)	Refrigerant
4AYTXVH3A1830A	1½-2½ Ton	5/16 ^①	3/4 ^②	2	R-410A
4AYTXVH3A3654A	3-4 Ton	3/8	7/8 ^③	2	R-410A
4AYTXVH3A6060A	5 Ton	3/8	7/8	2	R-410A

- ① 1 1/2 ton requires 1/4" liquid line; reducer fittings provided.
- ② 1 1/2 ton requires 1/2" suction line, 2 ton requires 5/8; reducer fittings provided.
- ③ 3 & 3 1/2 ton requires 3/4" suction line; reducer fitting provided.

* Used with TXH coils only where approved for use with 2 compressor systems.

Notes:

- Use in place of FCCV (Above) on air handlers and coils
- Match TXV kit size to outdoor nominal cooling capacity
- Braze field connections

For complete equipment / combination selections, installation instructions and warranty information, please refer to Product Data/Ratings and/or Installers Guides and Limited Warranty Handbooks.



It's Hard To Stop A Trane.®

Equipment Date Identification

1980 – 2025

The nine (1980 thru 2004) digit serial numbers and all current ten (2004 to present) digit serial numbers on all Trane central air conditioning and heating products are employed to identify the year and fiscal week of product manufacture.

Year of manufactureFirst digit..... **M124X04CF**
 Fiscal week of manufacture.....Second and third digit **M124X04CF**
 Day of week of manufacture.....Fourth digit **M124X04CF**
 Consecutive order of productionLast Five digits **M124X04CF**

Exception – Accessories are an exception to the ten digit serial number assignment and may have only three digits to indicate date code. Coils which have only three digits to indicate date code are an exception to the nine digit serial number assignment.

Year	Residential, ID & OD ^① Light Commercial Products & Compressors	Ducane Oil ^① Horizontal Gas Furnaces ^②	Year	Residential, ID & OD ^① Light Commercial Products & Compressors	Ducane Oil ^① Horizontal Gas Furnaces ^②	Year	Residential, ID & OD ^① Light Commercial Products & Compressors	Ducane Oil ^① Horizontal Gas Furnaces ^②
1980	O, A	L	1997	M	97	2014	14	—
1981	T	M	1998	N	98	2015	15	—
1982	U	N	1999	P	99	2016	16	—
1983	W	9	2000	R	—	2017	17	—
1984	X	Q	2001	Z	—	2018	18	—
1985	Y	85	2002	2	—	2019	19	—
1986	S	86	2003	3	—	2020	20	—
1987	B	87	2004	4	—	2021	21	—
1988	C	88	2005	5	—	2022	22	—
1989	D	89	2006	6	—	2023	23	—
1990	E	90	2007	7	—	2024	24	—
1991	F	91	2008	8	—	2025	25	—
1992	G	92	2009	9 or 09	—			
1993	H	93	2010	10	—			
1994	J	94	2011	11	—			
1995	K	95	2012	12	—			
1996	L	96	2013	13	—			

① Beginning with 1/1/96 (L01) Ducane oil furnace production uses same date code method as gas furnace. Prior to 1/1/96 Ducane serial number used last four digits = date code, example HA1234569540 1995, 40th week.

Example: 123456-8 5 4 0

Year of manufacture _____ Fiscal week of manufacture _____

② Dedicated horizontal gas furnaces, production ceased after introduction of convertible furnaces.

Digit	Description	Current Digit Value Options
1 ST	Second to Last integer of the current calendar year	1 through 9 and blank space, Blank Space used when 0 (zero)
2 ND	Last integer of the current calendar year	0 through 9
3 RD	Fiscal Week (Tens numeral)	0 through 5
4 TH	Fiscal Week (Units numeral)	0 through 9
5 TH	Day of the Week	1 through 7
6 TH	Time Stamp	A through Z and 0 through 9, excluding I, O, Q, V, Y, and Z
7 TH	Time Stamp	A through Z and 0 through 9, excluding I, O, Q, V, Y, and Z
8 TH	Time Stamp	A through Z and 0 through 9, excluding I, O, Q, V, Y, and Z
9 TH	Assembly Line Designator	A through Z and 0 through 9, excluding I, O, Q, V, Y, and Z
10 TH	Plant Code	A, D, F, G, H, V, Y, X

Plant Codes: (starting around 1995)
A = Monterrey
D = Springhill, LA (used to be the last character of a 10 digit serial on Ft. Smith products when they were sold commercially back in the late 1980's)
F = Tyler, TX
G = Trenton, NJ
H = Ft. Smith, AR
L = Lynn Haven, FL
V = Vidalia, GA
X = Sourced products

Accessories/Information

For complete equipment / combination selections, installation instructions and warranty information, please refer to Product Data/Ratings and/or Installers Guides and Limited Warranty Handbooks.



Refrigerant Line Sets

Table AC/IN-5-A — Refrigerant Line Sets

Model Number	Gas Line ^{①②} Dia. O.D.	Liquid Line Dia. O.D. Length	Shipping Weight
TAYREFLN325	7/8	3/8 25	20
TAYREFLN330	7/8	3/8 30	24
TAYREFLN340	7/8	3/8 40	30
TAYREFLN350	7/8	3/8 50	39
TAYREFLN725	3/4	3/8 25	19
TAYREFLN730	3/4	3/8 30	22
TAYREFLN740	3/4	3/8 40	28
TAYREFLN750	3/4	3/8 50	35
TAYREFLN950	5/8	3/8 50	30

① Gas line 90° bend one end.

② Gas line insulation 3/4" thickness.

Note: Contains a holding charge of Nitrogen.

Table AC/IN-5-B — Refrigerant Line Sets

Model Number	Res Old Accs Part Number	Gas Line Dia. O.D.	Liquid Line Dia. O.D.	Length	Insulation	Insulation Type	Bend	Plain Ends	Flare Fittings	Shipping Weight (per carton)
KIT17586		3/4"	3/8"	50	1/2"	Ez Pull	No	Yes	No	25
KIT16990	TAYREFLN750	3/4"	3/8"	50	1/2"	Standard	No	Yes	No	25
KIT17583		3/4"	3/8"	35	1/2"	Ez Pull	No	Yes	No	19
KIT17000	TAYREFLN730	3/4"	3/8"	30	1/2"	Standard	No	Yes	No	16
KIT16980		3/4"	3/8"	50	3/8"	Standard	No	Yes	No	24
KIT17001		3/4"	3/8"	35	3/8"	Standard	No	Yes	No	17
KIT17596		7/8"	3/8"	50	1/2"	Ez Pull	No	Yes	No	32
KIT16992	TAYREFLN350	7/8"	3/8"	50	1/2"	Standard	No	Yes	No	32
KIT17593		7/8"	3/8"	35	1/2"	Ez Pull	No	Yes	No	23
KIT17006	TAYREFLN330	7/8"	3/8"	30	1/2"	Standard	No	Yes	No	20
KIT16978		7/8"	3/8"	50	3/8"	Standard	No	Yes	No	31
KIT17002		7/8"	3/8"	35	3/8"	Standard	No	Yes	No	22
KIT17656	TAYREFLN965	5/8"	3/8"	50	1/2"	Mini Split Ez Pull	No	No	Yes	24
KIT17655	TAYREFLN960	5/8"	3/8"	25	1/2"	Mini Split Ez Pull	No	No	Yes	13
KIT17650	TAYREFLN060	3/8"	1/4"	50	1/2"	Mini Split Ez Pull	No	No	Yes	15
KIT17649	TAYREFLN050	3/8"	1/4"	25	1/2"	Mini Split Ez Pull	No	No	Yes	9
KIT17652	TAYREFLN570	1/2"	1/4"	50	1/2"	Mini Split Ez Pull	No	No	Yes	18
KIT17651	TAYREFLN560	1/2"	1/4"	25	1/2"	Mini Split Ez Pull	No	No	Yes	10
KIT17806	TAYREFLN165	5/8"	1/4"	50	1/2"	Mini Split Ez Pull	No	No	Yes	22
KIT17805	TAYREFLN155	5/8"	1/4"	25	1/2"	Mini Split Ez Pull	No	No	Yes	12
KIT17715		3/8"	NO	164	1/2"	Ez Pull	No	Yes	No	25
KIT17906		1/4"	NO	164	1/2"	Ez Pull	No	Yes	No	19
KIT17907		1/2"	NO	164	1/2"	Ez Pull	No	Yes	No	35
KIT17723		5/8"	NO	164	1/2"	Ez Pull	No	Yes	No	46

Accessories/Information

For complete equipment / combination selections, installation instructions and warranty information, please refer to Product Data/Ratings and/or Installers Guides and Limited Warranty Handbooks.

Refrigerant HFC 410A (R-410A)

Tables contain no allowances for vertical lift!

Table AC/IN-6-A – Liquid Line Selection Table for R-410A Single Speed Systems

Maximum Allowable Liquid Line Pressure Drop =

Subtract .43 PSI for each foot of Liquid Lift (if any)

Do Not Exceed this value when selecting Liquid Line.

Tube O.D.	Rated BTUH	Pressure Drop (PSI) For Total Equivalent Length											
		20'	40'	60'	80'	100'	120'	140'	160'	180'	200'	220'	240'
1/4"	15000	4.5	9.0	13.6	18.1	22.6	27.1	31.6	36.2	40.7	45.2	49.7	—
	18000	6.3	12.6	18.8	25.1	31.4	37.7	44.0	—	—	—	—	—
	24000	15.4	30.8	46.2	—	—	—	—	—	—	—	—	—
5/16"	15000	1.2	2.4	3.5	4.7	5.9	7.1	8.3	9.4	10.6	11.8	13.0	14.2
	18000	1.6	3.3	4.9	6.6	8.2	9.8	11.5	13.1	14.8	16.4	18.0	19.7
	24000	2.8	5.5	8.3	11.0	13.8	16.6	19.3	22.1	24.8	27.6	30.4	33.1
	30000	4.1	8.3	12.4	16.6	20.7	24.8	29.0	33.1	37.3	41.4	45.5	49.7
	36000	5.8	11.6	17.3	23.1	28.9	34.7	40.5	46.2	—	—	—	—
	42000	7.7	15.4	23.0	30.7	38.4	46.1	—	—	—	—	—	—
3/8"	24000	1.0	1.9	2.9	3.8	4.8	5.8	6.7	7.7	8.6	9.6	10.6	11.5
	30000	1.4	2.9	4.3	5.8	7.2	8.6	10.1	11.5	13.0	14.4	15.8	17.3
	36000	2.0	4.0	6.1	8.1	10.1	12.1	14.1	16.2	18.2	20.2	22.2	24.2
	42000	2.7	5.3	8.0	10.6	13.3	16.0	18.6	21.3	23.9	26.6	29.3	31.9
	48000	3.4	6.8	10.2	13.6	17.0	20.4	23.8	27.2	30.6	34.0	37.4	40.8
	60000	5.1	10.3	15.4	20.6	25.7	30.8	36.0	41.1	46.3	—	—	—
1/2"	60000	1.0	2.1	3.1	4.2	5.2	6.2	7.3	8.3	9.4	10.4	11.4	12.5

Note 1: A blank space indicates a pressure drop of over 50 PSI.
 Note 2: Other existing sources of pressure drop, (solenoid valves, etc.) must be considered.
 Note 3: A vertical run with a heat pump system always results in a liquid lift (heating or cooling).
 Note 4: The smallest liquid line diameter that results in a total liquid line pressure drop of 50 PSI or less results in the most reliable system (fewer pounds of R-410A).
 Note 5: It is recommended to place units where 1/2" liquid line is not required due to the increased refrigerant volume imposed by the larger liquid line.
 Note 6: At the time this manual was printed all outdoor units were rated with 3/8" liquid line.

Table AC/IN-6-B – Allowable Vapor Line Diameters and BTUH Loss (R-410A Single Speed Systems)

Nominal Tons	Tube O.D. (Inches)	Press. Drop PSI/100 Ft.	BTUH Loss For Equivalent Length										
			40'	60'	80'	100'	120'	140'	160'	180'	200'	220'	240'
1.0	1/2	5.0	70	160	250	340	430	520	610	700	790	880	970
	5/8	1.5	20	50	73	100	130	155	180	210	235	265	290
1.5	1/2	10.8	173	410	640	875	1110	1340	1575	1810	2040	2275	2510
	5/8	3.1	50	120	185	250	320	385	450	520	585	655	720
	3/4	1.2	20	45	70	95	125	150	175	200	225	255	280
2.0	5/8	5.4	115	270	430	585	740	895	1050	1205	1360	1515	1670
	3/4	2.0	45	100	160	215	275	330	390	445	505	560	620
2.5	5/8	8.2	220	515	810	1110	1400	1695	1990	2290	2585	2880	3175
	3/4	3.0	80	190	295	405	515	620	730	840	945	1055	1160
	7/8	1.3	35	80	130	175	220	270	315	365	410	455	505
3.0	5/8	11.7	380	885	1390	1895	2400	2905	3410	3915	4425	4930	—
	3/4	4.3	140	325	510	700	880	1070	1255	1440	1625	1810	2000
	7/8	1.9	60	145	225	310	390	470	555	635	720	800	880
3.5	3/4	5.8	220	510	805	1095	1390	1680	1975	2265	2560	2850	3140
	7/8	2.5	95	220	345	475	600	725	850	975	1105	1230	1355
4.0	3/4	7.4	320	745	1170	1600	2025	2450	2875	3305	3730	4155	4580
	7/8	3.2	140	325	510	690	875	1060	1245	1430	1615	1795	1980
	1-1/8	.9	40	90	145	195	245	300	350	400	455	505	555
5.0	3/4	11.5	620	1450	2280	3105	3935	4760	5590	6415	7245	8073	8900
	7/8	4.9	265	615	970	1325	1675	2030	2380	2735	3080	3440	3795
	1-1/8	1.3	70	165	255	350	445	540	630	725	820	915	1005

Note 1: Shaded value indicates more than 10% capacity loss.
 Note 2: Blank space indicates more than 15% capacity loss.
 Note 3: Only approved for cooling units, do not use 1 1/8" vapor lines on heat pumps less than 5 ton.
 Note 4: If linear length exceeds 150 feet, add 2 ounces of approved compressor oil per every 10 feet in excess of 150 feet. (Example: if the actual line length is 170 feet, add 4 ounces of oil to the system)

This page contains limited data to fully determine if the application will work or to select required accessories. Please refer to publication SS-APG006F-EN for complete details and examples.

Refrigerant Piping Information for Two Stage Split Systems

Table AC/IN-7-A – Allowable Vapor and Liquid Line Diameters for Two Stage, Single Compressor Split Systems

Rated Line Sizes	Line Sizes		Service Valve Connection Size		Max Line & Lift Lengths	
	Vapor Line	Liquid Line	Vapor Line Connection	Liquid Line Connection	TOTAL Max Line Length (ft)	Max Lift (ft)
2 Ton HP	5/8"	3/8"	5/8"	3/8"	150'	50'
3 Ton HP	3/4"	3/8"	3/4"	3/8"	80'	25'
4 Ton HP	7/8"	3/8"	7/8"	3/8"	150'	50'
5 Ton HP	1-1/8"	3/8"	1-1/8"	3/8"	80'	25'

Alternate Line Sizes	Line Sizes		Service Valve Connection Size		Max Line & Lift Lengths	
	Vapor Line	Liquid Line	Vapor Line Connection	Liquid Line Connection	TOTAL Max Line Length (ft)	Max Lift (ft)
2 Ton HP	5/8"	3/8"	5/8"	3/8"	150'	50'
	3/4"	3/8"			80'	25'
3 Ton HP	5/8"	3/8"	3/4"	3/8"	150'	50'
	7/8"	3/8"			80'	25'
4 Ton HP	3/4"	3/8"	7/8"	3/8"	150'	50'
5 Ton HP	3/4"	3/8"	1-1/8"	3/8"	150'	50'
	7/8"	3/8"			150'	50'

Rated Line Sizes	Line Sizes		Service Valve Connection Size		Max Line & Lift Lengths	
	Vapor Line	Liquid Line	Vapor Line Connection	Liquid Line Connection	TOTAL Max Line Length (ft)	Max Lift (ft)
2 Ton AC	5/8", 3/4"	3/8"	5/8"	3/8"	150'	50'
3 Ton AC	5/8", 3/4", 7/8"	3/8"	3/4"	3/8"	150'	50'
4 Ton AC	3/4", 7/8"	3/8"	7/8"	3/8"	150'	50'
5 Ton AC	3/4", 7/8", 1-1/8"	3/8"	1-1/8"	3/8"	150'	50'

See Application Bulletin SS-APB011-EN

Table AC/IN-7-B – Equivalent Length (Ft.) of Non-Ferrous Valves and Fittings (Brazed)

O.D. Tube Size (Inches)	Globe Valve	Angle Valve	Short Radius Ell	Long Radius Ell	Tee Line Flow	Tee Branch Flow
1/2*	70	24	4.7	3.2	1.7	6.6
5/8	72	25	5.7	3.9	2.3	8.2
3/4	75	25	6.5	4.5	2.9	9.7
7/8	78	28	7.8	5.3	3.7	12.0
1-1/8	87	29	2.7	1.9	2.5	8.0
1-3/8	102	33	3.2	2.2	2.7	10.0
1-5/8	115	34	3.8	2.6	3.0	12.0

Information for this chart extracted by permission from A.R.I. Refrigerant Piping Data, page 28.

* For smaller sizes, use 1/2" values.

This page contains limited data to fully determine if the application will work or to select required accessories. Please refer to publication SS-APG006F-EN for complete details and examples.

For complete equipment / combination selections, installation instructions and warranty information, please refer to Product Data/Ratings and/or Installers Guides and Limited Warranty Handbooks.

Branch Circuit Wire Sizing Table/ Heater De-Rating Chart

BRANCH CIRCUIT WIRE SIZING TABLE

(Based on 2% Voltage Drop)

Chart is based on 75° C. wire. (Types FEPW, RH, RHW, THW, THW, THWN, XHHW, USE, AND ZW.)

Use Chart For Wire Sizing Only. Refer To Electrical Code, (Or Product Specs.) For Fuse Sizing

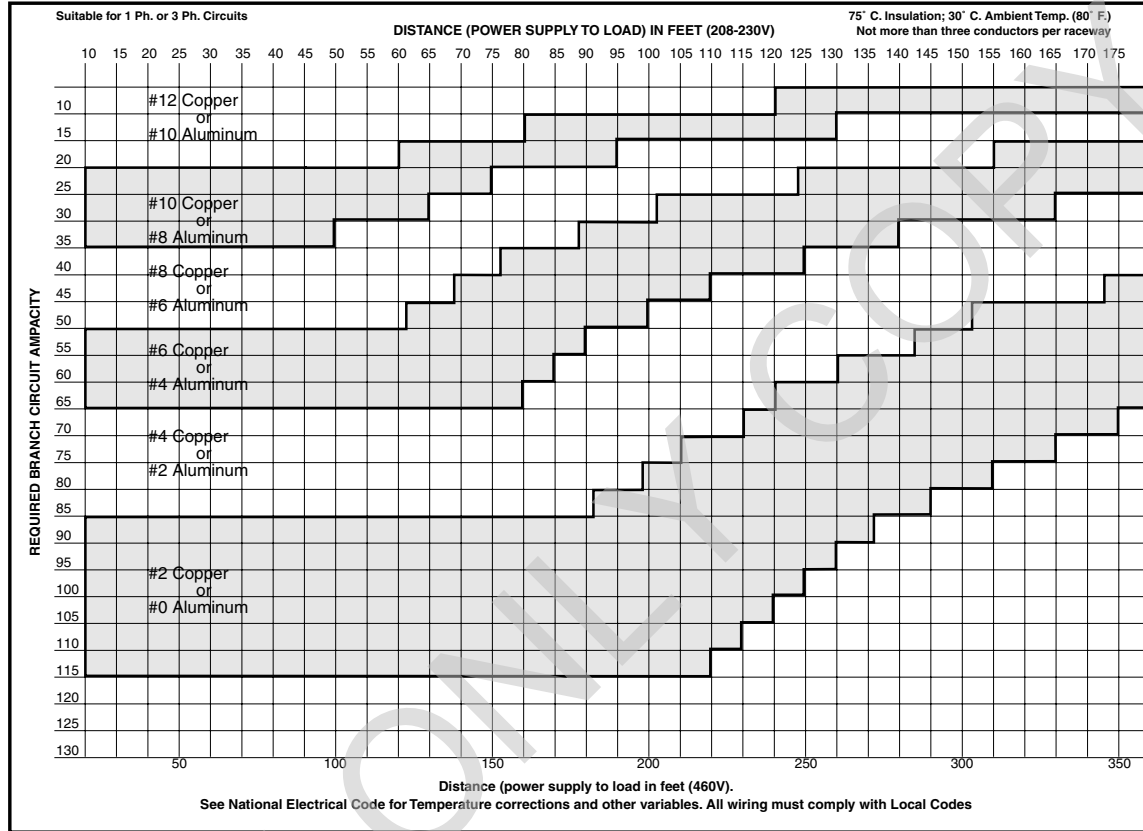

Heater De-Rating Chart

The output of electric heaters, applied at voltages other than the rated 240 or 480 volts, can be easily determined with the use of this chart.

ELECTRIC HEATER DE-RATING CHART (for 240V or 480V Rated Heaters Installed on Lower Voltage Systems)

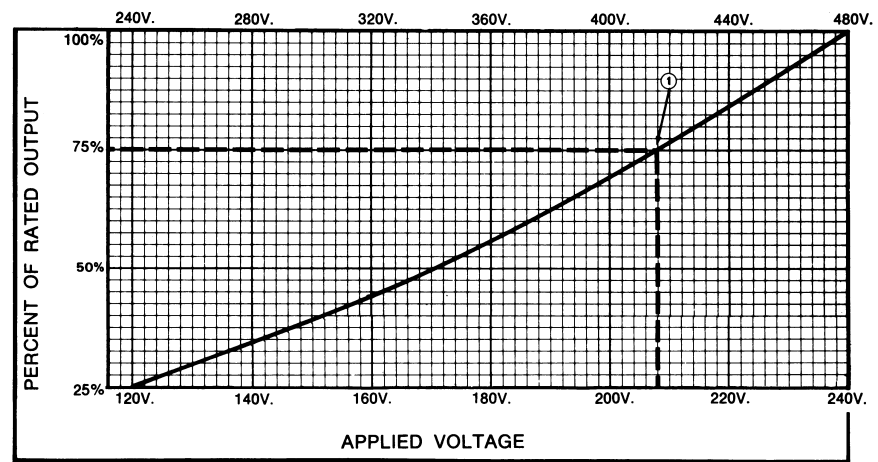

① EXAMPLE: Calculated Heat Loss — 29,200 BTUH Power Supply — 208V.
The chart indicates that any 240V heater will deliver 75% of its rated capacity at 208V.

$$\frac{29,200 \text{ BTUH}}{.75} = 39,000 \text{ BTUH} \quad \left\{ \begin{array}{l} \text{Select a heater having AT LEAST 39,000 BTUH} \\ \text{capacity at 240V.} \end{array} \right.$$

Basic Air Conditioning Formulas

Basic Air Conditioning Formulas

TO DETERMINE	EXPRESSED AS	COOLING	HEATING and/or HUMIDIFYING
Total Airflow	CFM _T	1. $CFM_T = \frac{N_T V}{60 \text{ min./hr.}}$	1. $CFM_T = \frac{N_T V}{60 \text{ min./hr.}}$
Infiltration or Ventilation	CFM _O	2. $CFM_O = \frac{N_O V}{60 \text{ min./hr.}}$	2. $CFM_O = \frac{N_O V}{60 \text{ min./hr.}}$
Number of Air Changes Per Hour – Total	N _T	3. $N_T = \frac{CFM_T (60 \text{ min./hr.})}{V}$	3. $N_T = \frac{CFM_T (60 \text{ min./hr.})}{V}$
Number of Air Changes Per Hour – Outdoor Air	N _O	4. $N_O = \frac{CFM_O (60 \text{ min./hr.})}{V}$	4. $N_O = \frac{CFM_O (60 \text{ min./hr.})}{V}$
Total Heat (H _T)	Btuh	5. $H_T = CFM_T \times 4.5 \times (h_1 - h_2) = \text{Btuh}$	6. $H_T = CFM_T \times 4.5 \times (h_2 - h_1) = \text{Btuh}$
Sensible Heat (H _S)	Btuh	7. $H_S = CFM_T \times 1.08 \times (T_1 - T_2) = \text{Btuh}$	8. $H_S = CFM_T \times 1.08 \times (T_2 - T_1) = \text{Btuh}$
Latent Heat (H _L)	Btuh	9. $H_L = CFM_T \times .68 \times (W_1 - W_2) = \text{Btuh}$	10. $H_L = CFM_T \times .68 \times (W_2 - W_1) = \text{Btuh}$
Entering Air Temperature (T ₁) (Mixed Air)	°F. D.B.	11. $T_1 = t_1 + \frac{CFM_O}{CFM_T} \times (t_2 - t_1) = \text{°F.D.B. } \textcircled{1}$ ① If duct heat gain is a factor, add to T ₁ : $\frac{\text{Duct Heat Gain (Btuh)}}{CFM_T \times 1.08}$	12. $T_1 = t_1 - \frac{CFM_O}{CFM_T} \times (t_1 - t_2) = \text{°F.D.B. } \textcircled{2}$ ② If duct heat loss is a factor, subtract from T ₁ : $\frac{\text{Duct Heat Loss (Btuh)}}{CFM_T \times 1.08}$
Leaving Air D.B. Temperature (T ₂)	°F. D.B.	13. $T_2 = T_1 - \frac{H_S}{CFM_T \times 1.08} = \text{°F.D.B.}$	14. $T_2 = T_1 + \frac{H_S}{CFM_T \times 1.08} = \text{°F.D.B.}$
Required Airflow	CFM _T	15. $CFM_T = \frac{H_S (\text{total})}{1.08 \times (T_1 - T_2)} = \text{CFM}$ OR $CFM_T = \frac{H_S (\text{internal}) \textcircled{3}}{1.08 \times (t_1 - T_2)} = \text{CFM}$ ③ Sensible load of outside air not included	16. $CFM_T = \frac{H_S}{1.08 \times (T_2 - T_1)} = \text{CFM}$
Enthalpy – Leaving Air (h ₂)	Btu/lb. dry air	17. $h_2 = h_1 - \frac{H_T}{CFM_T \times 4.5} = \text{Btu/lb. dry air}$	18. $h_2 = h_1 + \frac{H_T}{CFM_T \times 4.5} = \text{Btu/lb. dry air}$
Leaving Air W.B. Temperature	°F.W.B.	19. Refer to Enthalpy Table and read W.B. temperature corresponding to enthalpy of leaving air (h ₂) (see #17).	20. Refer to Enthalpy Table and read W.B. temperature corresponding to enthalpy of leaving air (h ₂) (see #18).
Heat Required to Evaporate Water Vapor Added to Ventilation Air	Btuh	21. $H_L = CFM_O \times .68 (W_3 - W_O) = \text{Btuh}$	22. $H_L = CFM_O \times .68 (W_3 - W_O) = \text{Btuh}$
Humidification Requirements	Lbs. water/hr.	23. $\left(\begin{matrix} \text{Make up} \\ \text{Moisture} \end{matrix} \right) = \frac{\text{Excess Latent Capacity of System} \times \% \text{ Run Time}}{1060 \text{ Btu/lb.}} = \text{lbs./hr.}$ (Industrial Process Work)	24. $\left(\begin{matrix} \text{Make up} \\ \text{Moisture} \end{matrix} \right) = \frac{H_L \text{ loss Btuh (see \#22)}}{1060 \text{ Btu/lb.}} = \text{lbs./hr.}$

LEGEND	DERIVATION OF AIR CONSTANTS
<p>CFM_T = Total airflow cubic feet/min. CFM_O = Outdoor air cubic feet/min. N_T = Total air changes per hour N_O = Outdoor air, air changes per hour V = Volume of space cubic feet H_T = Total heat Btuh H_S = Sensible heat Btuh H_L = Latent heat Btuh * h₁ = Enthalpy or total heat of entering air * h₂ = Enthalpy or total heat of leaving air T₁ = Temperature of entering air T₂ = Temperature of leaving air T_{adp} = Apparatus dewpoint t₁ = Indoor design temperature t₂ = Outdoor design temperature W₁ = Grains of water/lb. of dry air at entering condition W₂ = Grains of water/lb. of dry air at leaving condition W₃ = Grains of water/lb. of dry air at indoor design conditions W_O = Grains of water/lb. of dry air at outdoor design conditions</p>	<p>The air constants below apply specifically to standard air which is defined as dry air at 70 °F and 14.7 P.S.I.A. (29.92 in. mercury column). They can, however, be used in most cooling calculations unless extremely precise results are desired.</p> <p>4.5 (To convert CFM to lbs./hr.)</p> <p>$4.5 = \frac{60 \text{ min./hr.}}{13.33}$ or $60 \times .075$</p> <p>Where 13.33 is the specific volume of standard air (cu.ft./lb.) and .075 is the density (lbs./cu.ft.)</p> <p>$1.08 = \frac{.24 \times 60}{13.33}$ or $.24 \times 4.5$</p> <p>.24 BTU = specific heat of standard air (BTU/LB/°F)</p> <p>$.68 = \frac{60}{13.33} \times \frac{1060}{7000}$ or $4.5 \times \frac{1060}{7000}$</p> <p>Where: 1060 = Average Latent Heat of water vapor (BTU/LB.). 7000 = Grains per lb.</p>

* See Enthalpy of air (Total Heat Content of Air) Table for exact values.



It's Hard To Stop A Trane.®

Low Ambient Cooling Operation Accessories

Table AC/IN-10-A - Split System Low Ambient Accessories

Air Conditioner Heat Pump	55° F. As Manufactured	55°F - 30°F	55°F - 30°F	55°F - 30°F	55°F - 30°F	30F - 20F or 30F - 0F see lowest approved OD ambient				
		Air Conditioner AY28X079②	Heat Pump AY28X084②	TXV-NB	CCHT	BAYLOAM107*	Start Kit③	Solenoid Valve (AC) ④	Windshield	Lowest Approved Outdoor Ambient Cooling Mode
13 SEER	X	X	X	X	X	BAYLOAM107	X	X	X	Approved to 0° F
14 SEER	X	X	X	X	X	BAYLOAM107	X	X	X	AC Approved to 20° F HP Approved to 10° F
15 SEER	X	X	X	X	X	BAYLOAM107	X	X	X	AC Approved to 20° F HP Approved to 10° F
16 SEER ①	X	X	X	X	X	BAYLOAM107①	X	X	X	AC Approved to 20° F HP Approved to 10° F
17 SEER ①	X	X	X	X	X	BAYLOAM107	X	X	X	AC Approved to 20° F HP Approved to 10° F
18 SEER ①	X	X	X	X	X	BAYLOAM107①	X	X	X	AC Approved to 20° F HP Approved to 10° F
18 SEER VS	X	Not Approved				Not Approved				Approved to 55° F
20 SEER VS	X	Not Approved				Not Approved				Approved to 55° F

① DO NOT apply BAYLOAM to model tonnages with variable speed condenser fan motors. Models with VS condenser fan motors are approved to 30°F

② AY28X*** EDC not required when indoor unit has EEV

③ VS 20 SEER OD units approved to 55°F

④ Liquid line solenoid shall be used for isolation purposes. Also used if liquid line is 1/2" and installed before the evaporator coil. See SS-APG006F-EN Refrigeration Piping Application Guide

⑤ Start Kit NOT required on 230v/460v/3 phase product

* All AC models may use BAYLOAM103 or BAYLOAM107

Trane convertible package units may be operated in the cooling mode to 55°F outdoor ambient temperature as shipped from the factory. Where required these units with the appropriate accessories may be applied to operate at outdoor temperatures below 55°F.

Table AC/IN-10-B - Package System Low Ambient Accessories

Packaged Convertible Air Conditioner, Heat Pump, Gas/Electric	55° F. As Manufactured	Below 55°F Use Accessories for Operation to the Lowest Approved Outdoor Ambient				Start Kit①	Lowest Approved Outdoor Ambient Cooling Mode
		EDC BAYLOAM011A	CCHT	BAYLOAM105A			
4TC**	X	X	X	X	X	20° F	
4WC**	X	X	X	X	X	10° F	
4YC**	X	X	X	X	X	20° F	
4DC*	X	X	X	X	X	10° F	
4WHC**	45° F	X	X		X	10° F	

① NO Start KIT on 3 phase product

Compressor Crankcase Heaters

- BAYCCHT101A for reciprocating compressors, 65 watt, 230vac
- BAYCCHT102A for 6.5" scroll compressors, 60 watt, 230vac
- BAYCCHT103A for 5.5" scroll compressors, 40 watt, 230vac
- BAYCCHT404B for 6.5" scroll compressors, 60 watt, 460vac
- BAYCCHT405A for 5.5" scroll compressors, 40 watt, 460vac
- BAYCCHT301 for 6.5" - 7.5" diameter scroll compressors 60 watt, 230vac
- BAYCCHT302 for 5.5" diameter scroll compressors 40 watt, 230vac

Start KITS

- BAYQSTK300A for 4TC & 4WC 230vac, Single Phase Only
- BAYQSTK301A for 4YC & 4DC 230vac, Single Phase Only

Please refer to publication SS-APG012B-EN for complete details and examples.

For complete equipment / combination selections, installation instructions and warranty information, please refer to Product Data/Ratings and/or Installers Guides and Limited Warranty Handbooks.

Accessories/Information



Model Nomenclature



AC and HP

Brand
A = RunTru by Trane
E = RunTru

Refrigerant Type
4 = R410A

Product Family
AC = Air Conditioner
HP = Heat Pump
HL = Side Discharge

Nominal Efficiency Rating
3 = 13.4 SEER2
4 = 14.3 SEER2
5 = 15.2 SEER2

Nominal Capacity
BTU/Hour x 1000

Major Development Sequence
Primary Design / Form Series
Alphabetic Character "A" through "Z"

Electric Power Supply
1 = 200-230V/1PH/60Hz or 208-230V/1PH/60Hz

Secondary Function
000 = No Secondary Function

Minor Design Sequence/Series - Design Change
Alphabetic Character "A" through "Z"

A 4 A C 4 0 4 8 A 1 0 0 A A



Furnace

Brand
A = RunTru™ Brand

Model Family (Nominal Efficiency)
80 = 80% Non-Condensing
95 = 95% + Condensing

Gas Valve Stages
1 = 1 Stage Gas Valve
2 = 2 Stage Gas Valve

Blower Type
P = PSC Motor
X = Constant Torque Motor
V = Variable Speed Motor

BTU Input (Nominal Heating Capacity)
BTU/Hour x 1000

Cabinet Width
A = 14.5"
B = 17.5"
C = 21"
D = 24.5"

Orientation
U = Upflow/Horizontal Right/Horizontal Left
D = Downflow
M = Multi-pace

Nominal Cooling Airflow (in tons)
Type
S = Standard system
T = 40ng/J NOx
L = 14 ng/J NOx

Major Development Sequence
Primary Design/Form Series
Alphabetic Letter A through Z

Minor Development Sequence/Series
Design Change
Alphabetic Letter A through Z

A 8 0 1 X 0 4 0 M 2 S A A A



Air Handler

Brand
A = RunTru by Trane
E = RunTru

Refrigerant Type
4 = R410A

Product Family
AH = Air Handler Unit

Nominal Efficiency Rating
4 = 14.3 SEER2
5 = 15.2 SEER2

Blower Type
P = PSC
V = Variable Speed
E = Constant Torque ECM

Nominal Capacity
BTU/HOUR x 1000

Major Development Sequence
Primary Design / Form Series
Alphabetic Character "A" through "Z"

Electric Power Supply Characteristics
1 = 200-230V/1PH/60Hz or 208-230V/1PH/60Hz

Cabinet Width Size
B = 18.5" J = 21"
C = 23.5" K = 24.5"
D = 26.5"

Refrigerant Control
3 = TXV Non-Bleed
6 = FCCV (Flow Control/Check Valve)

Placeholder
0 = Nothing/Blank

Minor Development Sequence/Series
Design Change
Alphabetic Letter A through Z

A 4 A H 4 P 2 4 A 1 B 3 0 A A



Air Handler - TMM

Brand
T = Trane

Product Type
E = Metal Cabinet
M = Metal Over Hot Water Heater

Convertability
M = Multi-pace 4-way

Product Tier
3 = Entry Level Multi-Speed
4 = Entry Level Multi-Speed
5 = Entry Level High Efficiency
6 = Entry Level Variable Speed
8 = Entry Level Comm/24V Variable Speed

Major Design Change

No Descriptor
0 = Air Handler / Coil

Size (Footprint) (W x D)
A = 20.5 x 15.0
B = 18.5 x 21.1 (TEM), 22.0 x 19.0 (TMM)
C = 23.5 x 21.1
D = 26.5 x 21.1

Cooling Size: Air Handler or Coil
0-9 = AH Coil - 1000 BTU's (18, 24, 30, 36, 42, 48, 60)

Airflow Type & Capability
S = Standard Efy, 1-5 - nom. Tonnage (cfm/ton)
M = Mid Efy Multi-Speed, 1-5 - nom. Tonnage (cfm/ton)
H = High Efy Variable, 1-5 - nom. Tonnage (cfm/ton)
V = High Efy Variable, 1-5 - nom. Tonnage (cfm/ton)

Power Supply
1 = 208-230/1/60

System Control Type
S = Standard - 24 VAC
C = CLII 13.8 VDC
D = Dual (24 VAC / CLII 13.8 VDC)

Minor Design Change

Service Digit - Not Orderable

1 2 3 4 5 6 7 8 9 10 11 12 13 14 15
T M M 4 A 0 B 3 6 M 3 1 S A A

For complete equipment / combination selections, installation instructions and warranty information, please refer to Product Data/Ratings and/or Installers Guides and Limited Warranty Handbooks.



Model Nomenclature



A 4 M X B 3 6 4 2 A C 6 H A A

Coils

- Brand _____
A = RunTru™ Brand
- Refrigerant Type _____
4 = R410A
- Position _____
M = Multi-position (Up/Down/Left/Right)
- Coil Design _____
X = Direct Expansion Evaporator Coil
- Cabinet Width _____
A = 14.5"
B = 17.5"
C = 21.0"
D = 24.5"
- Minimum Capacity _____
BTU/HOUR x 1000
- Maximum Capacity _____
BTU/HOUR x 1000
- Major Design Change _____
Alphabetic Letter A through Z
- Efficiency _____
C = Standard
- Refrigerant Control _____
3 = TXV
6 = FCCV (Flow Control/Check Valve)
- Coil Circuitry _____
H = Heat Pump
C = Cooling
- Minor Development Sequence/Series _____
Design Change
Alphabetic Letter A through Z
- Service Digit _____
Unit Parts Identifier A through Z



4 T C A 4 0 2 4 A 1 0 0 0 A A

Packaged Unit

- Refrigerant Type _____
4 = R410A
- Type _____
Y = Gas Electric
W = Heat Pump Packaged
T = A/C (Cooling, Electric Heat)
- Unit Functionality & Classification _____
C = Convertible
H = Dedicated Horizontal
- Brand _____
A = RunTru™ Brand
- Family SEER _____
4 = 14
- Cooling Capacity _____
Capacity (100K BTU/h)
- Major Modification _____
Major Design Modification A through Z
- Power Supply _____
1 = 230-208V/1/60
- Heating Capacity _____
Capacity (MBTU/H) 0 through 9
- Minor Development Sequence/Series _____
Design Change
Alphabetic Letter A through Z
- Service Digit _____
Unit Parts Identifier A through Z

RunTru™
Model Nomenclature



Split System Cooling Single Phase – 1½-5 Tons



**A4AC3
Air Conditioner**

Table RTSC-1-A – 13.4 SEER2 Split System Air Conditioner

Model Number	Power Supply	Nom. Cap. Cooling (BTUH)	Uncrated Dimensions (in.)			Shipping Weight (lbs.)	Sound** Rating	MCA*	Max. Fuse*	Line Size (in)	
			H	W	D					OD Gas	OD Liq.
A4AC3018D1000A	208/230/1/60	18,000	28.625	23.625	23.625	152	74	12.0	20	3/4	3/8
A4AC3023D1000A	208/230/1/60	24,000	32.625	23.625	23.625	152	75	14.0	20	3/4	3/8
A4AC3024D1000A	208/230/1/60	24,000	28.625	25.625	25.625	158	74	14.0	20	3/4	3/8
A4AC3030D1000A	208/230/1/60	30,000	28.625	29.75	29.75	179	75	16.0	25	3/4	3/8
A4AC3035D1000A	208/230/1/60	36,000	28.625	29.75	29.75	177	71	16.0	30	3/4	3/8
A4AC3036D1000A	208/230/1/60	36,000	32.625	29.75	29.75	185	71	16.0	30	3/4	3/8
A4AC3042D1000A	208/230/1/60	42,000	28.625	34.25	34.25	223	76	22.0	35	7/8	3/8
A4AC3048D1000A	208/230/1/60	48,000	28.625	34.25	34.25	223	76	24.0	40	7/8	3/8
A4AC3060D1000A	208/230/1/60	54,000	36.625	34.25	34.25	251	76	31.0	50	7/8	3/8



**A4AC4
Air Conditioner**

Table RTSC-1-B – 14.3 SEER2 Split System Air Conditioner

Model Number	Power Supply	Nom. Cap. Cooling (BTUH)	Uncrated Dimensions (in.)			Shipping Weight (lbs.)	Sound** Rating	MCA*	Max. Fuse*	Line Size (in)	
			H	W	D					OD Gas	OD Liq.
A4AC4018D1000A	208/230/1/60	18,000	28.625	25.625	25.625	158	74	14.0	20	3/4	3/8
A4AC4023D1000B	208/230/1/60	24,000	28.625	25.625	25.625	158	74	14.0	20	3/4	3/8
A4AC4024D1000A	208/230/1/60	24,000	28.625	29.75	29.75	175	73	13.0	20	3/4	3/8
A4AC4029D1000A	208/230/1/60	30,000	32.625	29.75	29.75	185	71	16.0	25	3/4	3/8
A4AC4030D1000A	208/230/1/60	30,000	36.625	29.75	29.75	220	73	17.0	25	3/4	3/8
A4AC4036D1000A	208/230/1/60	36,000	32.625	29.75	29.75	185	71	16.0	30	3/4	3/8
A4AC4042D1000A	208/230/1/60	42,000	36.625	34.25	34.25	246	71	20.0	35	7/8	3/8
A4AC4048D1000A	208/230/1/60	48,000	44.625	34.25	34.25	306	72	24.0	40	7/8	3/8
A4AC4060D1000A	208/230/1/60	54,000	44.625	34.25	34.25	306	71	28.0	50	7/8	3/8



**A4AC5
Air Conditioner**

Table RTSC-1-C – 15.2 SEER2 Split System Air Conditioner

Model Number	Power Supply	Nom. Cap. Cooling (BTUH)	Uncrated Dimensions (in.)			Shipping Weight (lbs.)	Sound** Rating	MCA*	Max. Fuse*	Line Size (in)	
			H	W	D					OD Gas	OD Liq.
A4AC5018D1000A	208/230/1/60	18,000	28.625	29.75	29.75	167	74	12.0	20	3/4	3/8
A4AC5024D1000A	208/230/1/60	24,000	28.625	29.75	29.75	175	73	13.0	25	3/4	3/8
A4AC5030D1000A	208/230/1/60	30,000	36.625	29.75	29.75	220	73	17.0	25	3/4	3/8
A4AC5036D1000A	208/230/1/60	36,000	36.625	34.25	34.25	246	71	18.0	30	3/4	3/8
A4AC5042D1000A	208/230/1/60	42,000	36.625	34.25	34.25	246	71	20.0	35	7/8	3/8
A4AC5048D1000A	208/230/1/60	48,000	44.625	34.25	34.25	306	72	24.0	40	7/8	3/8
A4AC5060D1000A	208/230/1/60	60,000	44.625	34.25	34.25	306	71	28.0	45	7/8	3/8

Note: Odd-number capacity in the model number, for 2.5 ton and below indicates smaller-footprint outdoor unit options. The even-number capacity models will have additional indoor matches and ratings options. Check AHRI.org and Comfortsite to verify system match ups. For example: A4AC3023D1000A or A4AC4029D1000A

* Information subject to change. Please confirm with current Product Data/Service Facts for current factory production.

** Rated in accordance with AHRI Standard 270-2008 (Min/Max when applicable.)



Split System Cooling Single Phase – 1½-5 Tons

Table RTSC-2-A – Features

	A4AC3	A4AC4	A4AC5
• SEER2 up to	13.40	14.80	15.20
• All-aluminum coil.....	✓	✓	✓
• Scroll compressor for quiet & reliable operation.....	✓	✓	✓
• Small unit footprint for tight spaces (1.5-5 Tons).....	✓	✓	✓
• Quiet operation 76 dB.....	✓	✓	✓
• Pre-painted steel cabinet & base pan.....	✓	✓	✓
• 5-year limited functional parts warranty.....	✓	✓	✓
• 10-year functional parts warranty with product registration*	✓	✓	✓
• Commercial Applications: Limited Warranty. All other functional parts 1 year.....	✓	✓	✓

* Registered Limited Warranty terms are available when you register within 60 days of installation. You can register online at RunTruHVAC.com or by phone at 855-260-2975, otherwise Trane's Base Limited Warranty terms will apply. Base Limited Warranty information on specific products can be found on ComfortSite.com.

Table RTSC-2-B – Optional Accessories

Model Number	Description			
AY28X079	Evap. Defrost Control Kit	✓	✓	✓
BAYCCHT301RES.....	Crankcase Heater Kit (Scroll).....	3.5 - 5.0	3.5 - 5.0	3.5 - 5.0
BAYCCHT302RES.....	Crankcase Heater Kit (Scroll).....	1.5 - 3.0	1.5 - 3.0	1.5 - 3.0
BAYISLT101	Rubber Isolators.....	✓	✓	✓
BAYLOAM108.....	External Low Ambient Kit.....	✓	✓	✓
BAYLEGS007.....	Snow Legs - 7" High (Black)	✓	✓	✓
BAYLEGS004.....	Snow Legs - 4" High (Black)	✓	✓	✓
BAYKSKT267.....	External Start Kit	✓	✓	✓
BAYSDEN003	Small Scroll Compressor Enclosures	1.5 - 3.0	1.5 - 3.0	1.5 - 3.0
BAYSDEN004	Large Scroll Compressor Enclosures	3.5 - 5.0	3.5 - 5.0	3.5 - 5.0

RunTru™
Split System Cooling

ONLINE ONLY



Split System Heat Pumps Single Phase – 1½-5 Tons



**A4HP4
Heat Pump**

Table RTSH-1-A – 14.3 SEER2 Split System Heat Pump

Model Number	Power Supply	Nom. Cap. Cooling (BTUH)	Uncrated Dimensions (in.)			Shipping Weight (lbs.)	Sound** Rating	MCA*	Max. Fuse*	Line Size (in)	
			H	W	D					OD Gas	OD Liq.
A4HP4017D1000A	208/230/1/60	18,000	28.625	25.625	25.625	167	75	12	20	3/4	3/8
A4HP4018D1000A	208/230/1/60	18,000	32.625	29.75	29.75	196	75	15	20	3/4	3/8
A4HP4024D1000A	208/230/1/60	24,000	32.625	29.75	29.75	196	75	15	20	3/4	3/8
A4HP4030D1000A	208/230/1/60	30,000	28.625	29.75	29.75	187	75	15	25	3/4	3/8
A4HP4036D1000A	208/230/1/60	36,000	36.625	34.25	34.25	246	70	18	30	7/8	3/8
A4HP4042D1000A	208/230/1/60	42,000	44.625	34.25	34.25	277	72	24	35	7/8	3/8
A4HP4048D1000A	208/230/1/60	48,000	44.625	34.25	34.25	300	72	26	40	7/8	3/8
A4HP4060D1000A	208/230/1/60	54,000	44.625	34.25	34.25	300	72	32	50	7/8	3/8



**A4HP5
Heat Pump**

Table RTSH-1-B – 15.2 SEER2 Split System Heat Pump

Model Number	Power Supply	Nom. Cap. Cooling (BTUH)	Uncrated Dimensions (in.)			Shipping Weight (lbs.)	Sound** Rating	MCA*	Max. Fuse*	Line Size (in)	
			H	W	D					OD Gas	OD Liq.
A4HP5018D1000A	208/230/1/60	18,000	32.625	29.75	29.75	196	75	15	20	3/4	3/8
A4HP5024D1000A	208/230/1/60	24,000	32.625	29.75	29.75	196	75	15	25	3/4	3/8
A4HP5030D1000A	208/230/1/60	30,000	28.625	29.75	29.75	187	75	15	25	3/4	3/8
A4HP5036D1000A	208/230/1/60	36,000	36.625	34.25	34.25	246	70	18	30	3/4	3/8
A4HP5042D1000A	208/230/1/60	42,000	44.625	34.25	34.25	277	72	24	35	7/8	3/8
A4HP5048D1000A	208/230/1/60	48,000	44.625	34.25	34.25	300	72	26	40	7/8	3/8
A4HP5060D1000A	208/230/1/60	54,000	44.625	34.25	34.25	300	72	32	45	7/8	3/8

COMING SOON – Q2 2023



**E4HL5
Heat Pump
(Side Discharge)**

Table RTSH-1-C – 15.2 SEER2 Split System Side Discharge Heat Pump

Model Number	Power Supply	Nom. Cap. Cooling (BTUH)	Uncrated Dimensions (in.)			Shipping Weight (lbs.)	Sound** Rating	MCA*	Max. Fuse*	Line Size (in)	
			H	W	D					OD Gas	OD Liq.
E4HL5018A1000A	208/230/1/60	18,000	31.625	35.75	14.125	161	60	21.69	38.16	3/4	3/8
E4HL5024A1000A	208/230/1/60	24,000	31.625	35.75	14.125	161	60	21.69	38.16	3/4	3/8
E4HL5030A1000A	208/230/1/60	30,000	31.625	35.75	14.125	176	63	22.34	39.33	3/4	3/8
E4HL5036A1000A	208/230/1/60	34,000	31.625	35.75	14.125	176	63	22.34	39.33	3/4	3/8
E4HL5042A1000A	208/230/1/60	42,000	52.375	37.375	14.375	238	65	32.96	57	7/8	3/8
E4HL5048A1000A	208/230/1/60	48,000	52.375	37.375	14.375	238	65	32.96	57	7/8	3/8
E4HL5060A1000A	208/230/1/60	54,000	52.375	37.375	14.375	251	67	35.89	62.29	7/8	3/8

Note: The 3T and 5T E4HL models have a capacity switch to change down to 2T and 4T, respectively. Example: E4HL5036A1000A can be switched to 2ton prior to install. Additionally, each E4HL model includes a dip switch that can change from HP to AC only prior to install.

* Information subject to change. Please confirm with current Product Data/Service Facts for current factory production.

** Rated in accordance with AHRI Standard 270-2008 (Min/Max when applicable.)



Split System Heat Pumps Single Phase – 1½-5 Tons

Table RTSH-2-A – Features

	A4HP4	A4HP5
• SEER2 up to	14.30	15.20
• HSFP2 up to	7.8	7.8
• All-aluminum coil.....	✓	✓
• Scroll compressor for quiet & reliable operation.....	✓	✓
• Small unit footprint for tight spaces (1.5-5 Tons).....	✓	✓
• Quiet operation 76 dB.....	✓	✓
• Pre-painted steel cabinet & base pan.....	✓	✓
• 5-year functional parts limited warranty.....	✓	✓
• 10-year functional parts warranty with product registration*	✓	✓
• Commercial Applications: Limited Warranty. All other functional parts 1 year.....	✓	✓

* Registered Limited Warranty terms are available when you register within 60 days of installation. You can register online at RunTruHVAC.com or by phone at 855-260-2975, otherwise Trane's Base Limited Warranty terms will apply. Base Limited Warranty information on specific products can be found on ComfortSite.com.

Table RTSH-2-B – Optional Accessories

Model Number	Description		
AY28X079	Evap. Defrost Control Kit	✓	✓
BAYCCHT301RES	Crankcase Heater Kit (Scroll).....	3.5 - 5.0	3.5 - 5.0
BAYCCHT302RES	Crankcase Heater Kit (Scroll).....	1.5 - 3.0	1.5 - 3.0
BAYISLT101	Rubber Isolators.....	✓	✓
BAYLOAM108.....	External Low Ambient Kit.....	✓	✓
BAYLEGS007.....	Snow Legs - 7" High (Black)	✓	✓
BAYLEGS004.....	Snow Legs - 4" High (Black)	✓	✓
BAYKSKT267.....	External Start Kit	✓	✓
BAYSDEN003	Small Scroll Compressor Enclosures	1.5 - 3.0	1.5 - 3.0
BAYSDEN004	Large Scroll Compressor Enclosures	3.5 - 5.0	3.5 - 5.0

RunTru™ Split System Heat Pumps

For complete equipment / combination selections, installation instructions and warranty information, please refer to Product Data/Ratings and/or Installers Guides and Limited Warranty Handbooks.



Split System Air Handlers Single Phase 1½-5 Tons



A4AH4
Multi-position
Air Handlers

Table RTAH-1-A – R-410A 14.3 SEER2 Multi-position Air Handlers 208-230/1/60

Model Number	Capacity Range (Tons)	Uncrated Dimensions (in.)			Shipping Weight (lbs.)	Supply Opening	Return Opening	Refrigerant Control	Motor Desc.	Line Size (in)	
		H	W	D						Gas	Liquid
A4AH4E24A1B60A	1.5 - 3.0	45.02	18.50	21.13	116	12.15 x 16.50	18.75 x 16.75	FCCV	1/3 HP CTM	3/4	3/8
A4AH4E30A1B30A	1.5 - 3.0	46.77	18.50	21.13	145	12.15 x 16.50	18.75 x 16.75	TXV	1/3 HP CTM	3/4	3/8
A4AH4E36A1C30A	2.5 - 4.0	51.27	23.50	21.13	155	12.15 x 21.50	18.75 x 21.75	TXV	1/2 HP CTM	7/8	3/8
A4AH4E42B1C30A	3.0 - 4.0	51.27	23.50	21.13	155	12.15 x 21.50	18.75 x 21.75	TXV	1/2 HP CTM	7/8	3/8
A4AH4E48B1C30A	3.5 - 5.0	57.40	23.50	21.13	185	12.15 x 21.50	18.75 x 21.75	TXV	3/4 HP CTM	7/8	3/8
A4AH4E60B1C30A	3.5 - 5.0	57.40	23.50	21.13	185	12.15 x 21.50	18.75 x 21.75	TXV	3/4 HP CTM	7/8	3/8



A4AH5
Multi-position
Air Handlers

Table RTAH-1-B – R-410A 15.2 SEER2 Multi-position Air Handlers 208-230/1/60

Model Number	Capacity Range (Tons)	Uncrated Dimensions (in.)			Shipping Weight (lbs.)	Supply Opening	Return Opening	Refrigerant Control	Motor Desc.	Line Size (in)	
		H	W	D						Gas	Liquid
A4AH5E19A1B30A	1.0 - 2.0	45.20	18.50	21.13	116	12.15 x 16.50	18.75 x 16.75	TXV	1/3 HP CTM	3/4	3/8
A4AH5E31A1B30A	1.5 - 3.0	46.77	18.50	21.13	126	12.15 x 16.50	18.75 x 16.75	TXV	1/3 HP CTM	3/4	3/8
A4AH5E43A1C30A	3.0 - 4.0	51.27	23.50	21.13	145	12.15 x 21.50	18.75 x 21.75	TXV	1/2 HP CTM	7/8	3/8
A4AH5E49A1C30A	3.5 - 5.0	57.40	23.50	21.13	185	12.15 x 21.50	18.75 x 21.75	TXV	3/4 HP CTM	7/8	3/8
A4AH5E61A1C30A	3.5 - 5.0	57.40	23.50	21.13	185	12.15 x 21.50	18.75 x 21.75	TXV	3/4 HP CTM	7/8	3/8
A4AH5V24A1B30A	1.5 - 2.5	46.77	18.50	21.13	126	12.15 x 16.50	18.75 x 16.75	TXV	1/3 HP VS	7/8	3/8
A4AH5V30A1B30A	2.0 - 3.0	46.77	18.50	21.13	126	12.15 x 16.50	18.75 x 16.75	TXV	1/2 HP VS	3/4	3/8
A4AH5V36A1C30A	2.0 - 3.5	51.27	23.50	21.13	145	12.15 x 21.50	18.75 x 21.75	TXV	1/2 HP VS	3/4	3/8
A4AH5V42A1C30A	3.0 - 5.0	51.27	23.50	21.13	145	12.15 x 21.50	18.75 x 21.75	TXV	1/2 HP VS	7/8	3/8
A4AH5V48A1C30A	3.0 - 5.0	57.40	23.50	21.13	185	12.15 x 21.50	18.75 x 21.75	TXV	3/4 HP VS	7/8	3/8
A4AH5V60A1C30A	3.5 - 5.0	57.40	23.50	21.13	185	12.15 x 21.50	18.75 x 21.75	TXV	3/4 HP VS	7/8	3/8

COMING SOON – Q2 2023

Table RTAH-1-C – R-410A 15.2 SEER2 Upflow/Horizontal Air Handlers 208-230/1/60 (Specific for E4HL OD)

Model Number	Capacity Range (Tons)	Uncrated Dimensions (in.)			Shipping Weight (lbs.)	Supply Opening	Return Opening	Refrigerant Control	Motor Desc.	Line Size (in)	
		H	W	D						Gas	Liquid
E4AH5E24A1J30A	1.5 - 2.0	46.50	21.00	21.00	123	10.312 x 19.25	16 x 13.875	TXV	1/2 HP CTM	3/4	3/8
E4AH5E36A1J30A	2.5 - 3.0	46.00	21.00	21.00	154	10.312 x 19.25	16 x 13.875	TXV	1/2 HP CTM	3/4	3/8
E4AH5E48A1K30A	3.5 - 4.0	56.00	24.50	21.00	207	10.312 x 22.75	16 x 15.25	TXV	3/4 HP CTM	7/8	3/8
E4AH5E60A1K30A	5.0	56.00	24.50	21.00	212	10.312 x 22.75	16 x 15.25	TXV	3/4 HP CTM	7/8	3/8



E4AH5
Upflow/Horizontal
Air Handlers

Notes:
Filter not supplied, remote filter required.
E4AH models compatible ONLY with E4HL side discharge outdoor.
Copper tube, aluminum fin design
Electric heat kit available, reference installer's guide



Split System Air Handlers

Single Phase 1½-5 Tons

Table RTAH-2-A – Features

	A4AH4	A4AH5
• Multi-Position Upflow / Downflow*, Horizontal Left /Right	✓	✓
• Unpainted galvanized metal cabinet with captured foil face insulation	✓	✓
• R-4.2 Insulating Value	✓	✓
• Wipeable interior design.....	✓	✓
• 2% or less air leakage	✓	✓
• All Aluminum Coil with Enhanced Patented Coil Fin	✓	✓
• Factory installed orifice with mechanical connections on both sides.....	2.0	—
• Factory installed R-410A Thermal Expansion Valve with mechanical connections on both sides.....	2.5-5.0	✓
• Optional field installed TXV kits with mechanical fittings for higher performance	2.0	—
• Constant Torque ECM Motor.....	✓	A4AH5E
• VSPD ECM Motor	—	A4AH5V
• Electric Heaters with polarized plug connections (sold as accessory & field installed).....	✓	✓
• Low Voltage Pigtail Connections	✓	✓
• Fused 24V Power.....	✓	✓
• Maximum Width 23.5"	✓	—
• Compact depth.....	21"	21"
• Draw through design.....	✓	✓
• Approved for manufactured/mobile home use	✓	✓
• 5-year functional parts limited warranty/No Registration Required	✓	✓
• 10-year functional parts warranty with product registration*	✓	✓
• Commercial Applications: Limited Warranty. All other functional parts 1 year	✓	✓

* Registered Limited Warranty terms are available when you register within 60 days of installation. You can register online at RunTruHVAC.com or by phone at 855-260-2975, otherwise Trane's Base Limited Warranty terms will apply. Base Limited Warranty information on specific products can be found on ComfortSite.com.

Table RTAH-2-B – Optional Accessories

Model Number	Description	Matches Cabinet Size(s)	A4AH4	A4AH5
BAYTEMSPFG1	Supply Duct Flange Kit	18.5" and 23.5	✓	✓
BAYSPEKT201A	Single Point Power Entry Kit	18.5" and 23.5	✓	✓
TAYBASE185.....	Air Handler Downflow Sub-Bases.....	18.5"	✓	✓
TAYBASE235 (TAYBASE100) ..	Air Handler Downflow Sub-Bases.....	23.5"	✓	✓
BAYTEMDFKT1A	Downflow Condensate Management Kit.....	23.5"①	✓	✓
BAYAHEMIKIT001	Air handler Electronic Noise Kit used on Variable Speed Blower Motor	✓	✓
TEMBRKSEALKT01A	Breaker Seal Kit for use with BAYHTR15 4kW 20 kW Heaters.....	✓	✓
BAYSF1185AAA.....	Slim Fit Filter Box Kit	18.5"	✓	✓
BAYSF1235AAA.....	Slim Fit Filter Box Kit	23.5"	✓	✓
FLRSF1185	1" Slim Fit Replacement Filter, 17.75"x19.75", Qty 12	18.5"	✓	✓
FLRSF1235	1" Slim Fit Replacement Filter, 22.75"x19.75", Qty 12	23.5"	✓	✓
BAY4TXV1830A	R-410A TXV kit	1½-2½/2	—
BAYATXV1836B	R-22 TXV conversion kit	1½-2½/2	—
BAYATXV4248B	R-22 TXV conversion kit	3-4	—
BAYATXV6161B	R-22 TXV conversion kit	5	—
BAY6TXV2442A	R-22 conversion kit for 2-3.5 Ton models.....	—	✓
BAY6TXV4860A	R-22 conversion kit for 4-5 Ton D models	—	✓
BAY6TXV6161C	R-22 conversion kit for 4-5 Ton C models	—	✓

① Downflow condensate management kit is required for 5 Ton downflow models.



Heaters for Split System Air Handlers

Table RTAH-3-A – BAYHTR15 – Heater, Standard, for A4AH4 and A4AH5 Air Handlers

Heater Model Number	Capacity @ 240 Volts		Capacity @ 208 Volts		Rated Voltage	Control Stages	Number of Heater Racks	Number of Circuits	Heater Amps per Circuit		Contains Circuit Breakers
	kW	BTUH	kW	BTUH					208 Volts	240Volt	
BAYHTR1504BRKC	3.84	13100	2.88	9800	208/240/1/60	1	1	1	13.8	16	Yes
BAYHTR1504LUGB	3.84	13100	2.88	9800	208/240/1/60	1	1	1	13.8	16	No
BAYHTR1505BRKC	4.80	16400	3.60	12300	208/240/1/60	1	1	1	17.3	20	Yes
BAYHTR1505LUGB	4.80	16400	3.60	12300	208/240/1/60	1	1	1	17.3	20	No
BAYHTR1508BRKC	7.68	26200	5.76	19700	208/240/1/60	1	1	1	27.7	32	Yes
BAYHTR1508LUGB	7.68	26200	5.76	19700	208/240/1/60	1	1	1	27.7	32	No
BAYHTR1510BRKC	9.60	32800	7.20	24600	208/240/1/60	1	2	1	34.6	40	Yes
BAYHTR1510LUGB	9.60	32800	7.20	24600	208/240/1/60	1	2	1	34.6	40	No
BAYHTR1515BRKB	14.4	49200	10.8	36900	208/240/1/60	2	3	2	51.9	60	Yes
BAYHTR1516BRKA	14.4	49200	10.8	36900	208/240/1/60	2	3	2	51.9	60	Yes
BAYHTR1517BRKA	14.4	49200	10.8	36900	208/240/1/60	2	3	2	51.9	60	Yes
BAYHTR1519BRKB	19.2	65500	14.4	49200	208/240/1/60	2	4	2	69.2	80	Yes
BAYHTR1520BRKB	19.2	65500	14.4	49200	208/240/1/60	2	4	2	69.2	80	Yes
BAYHTR1521BRKB	19.2	65500	14.4	49200	208/240/1/60	2	4	2	69.2	80	Yes
BAYHTR1522BRKA	19.2	65500	14.4	49200	208/240/1/60	2	4	2	69.2	80	Yes
BAYHTR1523BRKA	19.2	65500	14.4	49200	208/240/1/60	2	4	2	69.2	80	Yes
BAYHTR1525BRKA	24.0	81900	18.0	61600	208/240/1/60	2	4	2	86.4	100	Yes

Table RTAH-3-B – BAYHTR35 – Heater, 3-Phase, for A4AH4 and A4AH5 Air Handlers

Heater Model Number	Capacity @ 240 Volts		Capacity @ 208 Volts		Rated Voltage	Control Stages	Number of Heater Racks	Number of Circuits	Heater Amps per Circuit		Contains Circuit Breakers
	kW	BTUH	kW	BTUH					208 Volts	240Volt	
BAYHTR3510LUGC	9.60	32800	7.20	24600	208/240/3/60	1	3	1	20.0	23.1	No
BAYHTR3515LUGC	14.4	49200	10.8	36900	208/240/3/60	1	3	1	30.0	34.6	No
BAYHTR3517LUGA	14.4	49200	10.8	36900	208/240/3/60	1	3	1	30.0	34.6	No

BRK = Contains circuit breakers

LUG = Lug connections

① 3-Phase - W1 and W2 must be jumpered at low voltage connector

Table RTAH-3-C – A4AH4 and A4AH5 Air Handler and Heater matches

AIR HANDLER	HEATER MATRIX				
	HEATER MODEL NUMBER				
MODEL NUMBER	BAYHTR1504BRKC BAYHTR1504LUGB 3.84 Kw BK BAYHTR1505BRKC BAYHTR1505LUGB 4.80 Kw BK	BAYHTR1508BRKC BAYHTR1508LUGB 7.68 Kw BK BAYHTR1510BRKC BAYHTR1510LUGB BAYHTR3510LUGC 9.60 Kw BK	BAYHTR1517BRKA BAYHTR3517LUGA 14.40 Kw BK	BAYHTR1523BRKA 19.20 Kw BK	BAYHTR1525BRKA 24.00 Kw BK
A4AH4E24A1B60A	Y	Y	--	--	--
A4AH4E30A1B30A	Y	Y	Y	--	--
A4AH4E36A1C30A	Y	Y	Y	Y	--
A4AH4E42B1C30A	Y	Y	Y	Y	Y
A4AH4E48B1C30A	Y	Y	Y	Y	Y
A4AH4E60B1C30A	Y	Y	Y	Y	Y
A4AH5E19A1B30A	Y	Y			
A4AH5V24A1B30A	Y	Y	Y		
A4AH5V30A1B30A	Y	Y	Y		
A4AH5E31A1B30A	Y	Y	Y	Y	
A4AH5V36A1C30A	Y	Y	Y	Y	
A4AH5V42A1C30A	Y	Y	Y	Y	
A4AH5E43A1C30A	Y	Y	Y	Y	
A4AH5E49A1C30A	Y	Y	Y	Y	Y
A4AH5E61A1C30A	Y	Y	Y	Y	Y
A4AH5V48A1C30B	Y	Y	Y	Y	Y
A4AH5V60A1C30B	Y	Y	Y	Y	Y

For complete equipment / combination selections, installation instructions and warranty information, please refer to Product Data/Ratings and/or Installers Guides and Limited Warranty Handbooks.



TMM Wall, Stud, or Over the Water Heater Mount Air Handlers Single Phase 1½-3 Tons

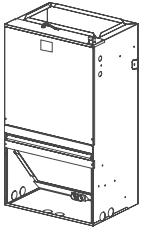

Table RTAH-4-A – TMM5 R-410A Wall, Stud, or Over the Water Heater Mount Air Handler 208-230/1/60, ECM Motor, Factory installed R-410A TXV, all aluminum coil, Cooling & Limited Heating

Unit Model No.	Cooling Capacity (Btuh)	Dimensions (in.) H x W x D	Shipping Weight (lbs.)	Supply Opening	Filter Sizes	Line Size	
						Gas	Liquid
TMM5B0A24M21SA	24000	36.5 x 20.5 x 15.0	93	15 x 9.5	①	3/4	3/8
TMM5B0B30M21SA	30000	39.5 x 22.0 x 19.0	115	19 x 9.5	①	3/4	3/8
TMM5B0B36M31SA	36000	39.5 x 22.0 x 19.0	115	19 x 9.5	①	3/4	3/8

Table RTAH-4-B – TMM4 R-410A Wall, Stud, or Over the Water Heater Mount Air Handler 208-230/1/60, PSC Motor, Factory installed R-410A orifice, all aluminum coil, Cooling & Heating

Unit Model No.	Cooling Capacity (Btuh)	Dimensions (in.) H x W x D	Shipping Weight (lbs.)	Supply Opening	Filter Sizes	Line Size	
						Gas	Liquid
TMM4B0A18S21SA	18000	36.5 x 20.5 x 15.0	97	15 x 9.5	1	3/4	3/8
TMM4B0A24S21SA	24000	36.5 x 20.5 x 15.0	97	15 x 9.5	1	3/4	3/8
TMM4B0B30S21SA	30000	39.5 x 22.0 x 19.0	119	19 x 9.5	1	3/4	3/8
TMM4B0B36S31SA	36000	39.5 x 22.0 x 19.0	119	19 x 9.5	1	3/4	3/8

① Filter not supplied. Remote filter required.

Table RTAH-4-C – Features

	TMM5B 2-3	TMM4B 1-1/2-3
• Painted metal cabinet with captured foil face insulation	✓	✓
• 2% or less air leakage	✓	✓
• All aluminum coil	✓	✓
• Direct drive, multi speed ECM blower motor - Constant torque ECM (electronically commutated motor) with fan-off time delay programming.....	✓	—
• PSC Motor.....	—	✓
• Limited HP matched system ratings	—	✓
• R-4.2 Insulating Value	✓	✓
• Upflow only	✓	✓
• Front return option	✓	✓
• High Efficiency Copper / Aluminum Coil	✓	✓
• Electric Heaters with polarized plug connections (sold as accessory)	✓	✓
• R-410A Thermal Expansion Valve	✓	—
• Low Voltage Pigtail Connections	✓	✓
• Single Color	✓	✓
• Fused 24V Power	✓	✓
• Wipeable interior design.....	✓	✓
• Maximum Height 39.5".....	✓	✓
• Maximum Width 22".....	✓	✓
• Compact 22" depth.....	✓	✓
• Optional R-22 and R-410A TXV kits (sold as accessory)	✓	✓
• 10-year functional parts warranty with product registration	✓	✓
• Commercial Applications: Limited Warranty. All other functional parts 1 year	✓	✓



TMM Wall, Stud, or Over the Water Heater Mount Air Handlers Single Phase 1½-3 Tons

Table RTAH-5-A – Optional Accessories

Model Number	Description	TMM5B	TMM4B
4AYTXVH3G2436A	R-410A TXV kit 1-1/2 to 3 ton.....	—	✓
2AYTXVH3G2436A	R-22 TXV conversion kit 1-1/2 to 3 ton.....	✓	✓
BAYFRTLLOUPNL20.....	Front louver panel 20.5" width	—	✓
BAYFRTLLOUPNL22.....	Front louver panel 22.0" width	✓	✓
BAYTMMWALLPNL1..	Return air / service wall panel (Qty 20)	✓	✓

Heaters for TMM Split System Air Handlers

Table RTAH-5-B – BAYHTRM – Heater, Standard, for TMM Air Handlers

Heater Model Number	Capacity@ 240 Volts		Capacity@ 208 Volts		Rated Voltage	Control Stages	Number of Heater Racks	Number of Circuits	Heater Amps per Circuit		Contains Circuit Breakers
	kW	BTUH	kW	BTUH					208 Volts	240Volt	
BAYHTRM505BRK	5.0	17100	3.8	12800	208/240/1/60	1	1	1	18	20.8	Yes
BAYHTRM508BRK	7.5	25600	5.6	19200	208/240/1/60	1	1	1	27.1	31.2	Yes
BAYHTRM510BRK	10.0	34100	7.5	25600	208/240/1/60	1	2	1	36.1	41.7	Yes



Split System – Cased Heat Pump and Cooling Coils



**4MXC
Multi-Position
Cased Coils**

Table RTCOIL-1-A – Aluminum Single Stage Cased Coil (Upflow/Downflow/Horizontal) R-410A Refrigerant

Model Number	Cooling Capacity Range (Tons)	Coil Type	Refrigerant Control	Outlet Dim. (in.) W/H x D	Overall Dim. (in.) H x W x D	Shipping Weight (lbs.)	Line Size OD Gas	Line Size OD Liq.
4MXCA003AC6HCB	1.5 - 3.0	A	FCCV ^①	13 x 19	20 x 14.5 x 21	51	3/4	3/8
4MXCB004AC6HCB	1.5 - 3.0	A	FCCV ^①	16 x 19	20 x 17.5 x 21	55	3/4	3/8
4MXCC005AC6HCB	2.5 - 3.0	A	FCCV ^①	19 1/2 x 19	20 x 21 x 21	59	3/4	3/8
4MXCB006AC6HCB	3.0 - 4.0	A	FCCV ^①	16 x 19	26 x 17.5 x 21	66	7/8	3/8
4MXCC007AC6HCB	3.0 - 4.0	A	FCCV ^①	19 1/2 x 19	26 x 21 x 21	70	7/8	3/8
4MXCD008AC6HCB	3.5 - 4.0	A	FCCV ^①	23 x 19	26 x 24.5 x 21	74	7/8	3/8
4MXCC009AC3HCB	3.5 - 5.0	A	FCCV ^①	19 1/2 x 19	30 x 21 x 21	91	7/8	3/8
4MXCD010AC3HCB	3.5 - 5.0	A	FCCV ^①	23 x 19	30 x 24.5 x 21	95	7/8	3/8
4MXCB016AC6HCB ^②	3.0 - 4.0	A	FCCV ^①	16 x 19	30 x 17.5 x 21	82	7/8	3/8
4MXCC017AC6HCB ^②	3.0 - 4.0	A	FCCV ^①	19 1/2 x 19	30 x 21 x 21	88	7/8	3/8
4MXCD018AC6HCB ^②	3.5 - 4.0	A	FCCV ^①	23 x 19	30 x 24.5 x 21	92	7/8	3/8

^① All coils shipped with a Fixed Metering Device (Flow Control Check Valve - FCCV). Some rated combinations require a TXV kit, ordered separately. See the coil Installer's Guide for Orifice and TXV matches.

^② Enhanced models for use in heating.

Will be transitioning to unpainted cabinet during 2022.

Table RTCOIL-1-B – Features

	4MXC
• All aluminum coil	✓
• 100% foil lined insulation	✓
• Factory installed fixed orifice. Additional orifices supplied.	✓
• Optional accessory TXV Kit with mechanical fittings available for higher performance ratings ^①	✓
• Easy case attachment to furnace.....	✓
• Upflow application	✓
• Downflow application	✓
• Horizontal Right application.....	✓
• Horizontal Left application	✓
• Single sloped non-corrosive drain pan.....	✓
• Unpainted galvanized steel cabinet.....	✓
• 10-year limited warranty on coil, & all other functional parts, with registration*	✓
• Commercial Applications: Limited Warranty Coil and Parts 1 year	✓

^① Reference AHRI ratings to find correct TXV kit or reference Product Data for additional information.

* Registered Limited Warranty terms are available when you register within 60 days of installation. You can register online at RunTruHVAC.com or by phone at 855-260-2975, otherwise Trane's Base Limited Warranty terms will apply. Base Limited Warranty information on specific products can be found on ComfortSite.com.



Split System – Cased Heat Pump and Cooling Coils

Table RTCOIL-2-A – Refrigerant TXV Kits for 4MXC Coils

Tons	R-410A TXV Kit (If required)	R-22 TXV Kit (If required)
1.5-3.0	4AYTXVH3G2436A	2AYTXVH3G2436A
3.5-4.0	4AYTXVH3G4248A	2AYTXVH3G4248A
5	4AYTXVH3G6000A	2AYTXVH3G6000A

Note: Additional R-22 Kit combinations can be found in the Accessories section.

Table COIL-2-B – Orifice kit table for 4MXC coils

Outdoor Unit Capacity (Tons)	Orifice Size (R410A)	Orifice Kit	Orifice Size (R22)	Orifice Kit
1.5	0.052	MAYORIACHP0052B	0.052	MAYORIACHP0052B
2	0.058	MAYORIACHP0058B	0.058	MAYORIACHP0058B
2.5*	0.063 / 0.065	MAYORIACHP0063B / 065A	0.065	MAYORIACHP0065A
3	0.070	MAYORIACHP0070B	0.072	MAYORIACHP0072B
3.5	0.075	MAYORIACHP0075B	0.078	MAYORIACHP0078B
4	0.083	MAYORIACHP0083B	0.088	MAYORIACHP0088B
5	0.090	MAYORIACHP0090B	0.096	MAYORIACHP0096B

Note: Orifice size needed for system combination may not be pre-installed. See Table 1 in coil Installation Manual for pre-installed size.

* Necessary Orifice sizes varies for this tonnage. See Table 3 in coil Installation Manual.

RunTru™
Coils



A801X - Single Stage, ECM



A801X
Gas Furnace

Table RTFUR-1-A – A801X, Constant Torque ECM, 1 stage, 80% AFUE Gas Furnace

Model Number	CA Low NOx Model Number ^②	Input (BTUH)	AFUE	Flue Size (in.)	Ignition Device	Uncrated Dimensions (in.)			Shipping Weight (lbs.)	Max. Fuse*	Filter Sizes
						H	W	D			
A801X026AM2SCA	A801X026AM2TCA	26,000	80.0	4	①	34	14.5	28.75	102	15	14x25x1
A801X040BM2SCA	A801X040BM2TCA	40,000	80.0	4	①	34	14.5	28.75	102	15	14x25x1
A801X040AM3SCA	A801X040AM3TCA	40,000	80.0	4	①	34	17.5	28.75	128	15	16x25x1
A801X060BM4SCA	A801X060BM4TCA	60,000	80.0	4	①	34	17.5	28.75	132	15	16x25x1
A801X080BM4SCA	A801X080BM4TCA	80,000	80.0	4	①	34	17.5	28.75	137	15	16x25x1
A801X080CM5SCA	A801X080CM5TCA	80,000	80.0	4	①	34	21	28.75	142	15	20x25x1
A801X100CM5SCB	A801X100CM5TCB	100,000	80.0	4	①	34	21	28.75	144	15	20x25x1
A801X120DM5SCA	A801X120DM5TCA	120,000	80.0	4	①	34	24.5	28.75	160	15	24x25x1

① Silicon Nitride Igniter.

② These models comply with California 40 ng/J Low NOx regulations.

* Information subject to change. Please confirm with current Product Data/Service Facts for current factory production.

A801X High Altitude Kits

Table RTFUR-1-B – High Altitude Pressure Switch A801X Furnaces

Model Number	Description	Used With	Shipping Weight
BAYSWT14AHALTB	1 Switch	A801X080CM5SCA ^① , A801X100CM5SCB ^①	2
BAYSWT15AHALTA	1 Switch	A801X060BM3SCA ^① , A801X060BM4SCA ^① , A801X080BM4SCA ^①	2
BAYSWT20AHALTA	1 Switch	A801X026AM2SCA ^①	2
BAYSWT21AHALTA	1 Switch	A801X040AM3SCA ^① , A801X040BM2SCA ^①	2

Note: A801X120DM5 does not require a high altitude pressure switch kit.

① SAC and TAC or later



A801X - Single Stage, ECM

Table RTFUR-2-A — Features

	A801X
• AFUE	80.00
• 34" cabinet height	✓
• 4-Way Poise (Upflow, Downflow, Horizontal Left, Horizontal Right).....	✓
• Tubular Aluminized Steel Heat Exchanger	✓
• FER compliant	✓
• Gas can enter either side of cabinet.....	✓
• Multiple furnace venting options in each poise.....	✓
• Integrated Furnace Control board with digital configuration, status, and fault codes.....	✓
• Alpha-numeric diagnostic codes.....	✓
• Adjustable blower off delay for heating and cooling.....	✓
• Meets requirements for 1.4% cabinet air leakage.....	✓
• Front service access with easily accessible burners, sensors, orifices, switches, and other components.....	✓
• Cabinet has no knockouts - Rubber and plastic plugs come installed from factory	✓
• Multiple venting options - Every model, every size will offer two venting options	✓
• Longer IFC wire harnesses allow door to be removed without disconnecting the harness	✓
• Alternate bottom/left/right return air (except downflow).....	✓
• Bottom panel	✓
• Multi-port in shot burners.....	✓
• Silicon Nitride 120V hot surface igniter	✓
• Direct drive, 9 Speed Constant Torque ECM Blower Motor	✓
• Heavy gauge reinforced wrap-around steel cabinet	✓
• Service diagnostics with faults reported on IFC board	✓
• Manual reset flame roll out switches.	✓
• Slide out blower assembly on full-length rails.....	✓
• Side return duct starter tabs	✓
• Multiple heating blower speeds	✓
• 5-year functional parts limited warranty/No Registration Required.....	✓
• 10-year functional parts warranty with product registration*	✓
• Commercial Applications: Limited Warranty Heat exchangers 20 years. All other functional parts 1 year	✓

* Registered Limited Warranty terms are available when you register within 60 days of installation. You can register online at RunTruHVAC.com or by phone at 855-260-2975, otherwise Trane's Base Limited Warranty terms will apply. Base Limited Warranty information on specific products can be found on ComfortSite.com.

Table RTSC-2-B — Optional Accessories

Model Number	Description	Shipping Weight	
BAYLPSS400B	LP Kit with Stainless Steel Burners	3.....	(except 026)
BAYLPSS410A	LP Kit with Stainless Steel Burners	3.....	A801X026
BAYHANG	Horizontal hanging kit	2.....	✓
BAYSF1165A.....	1" SlimFit Box with MERV 4 Filter (side return)	5.....	✓
BAYFLTR203	Horizontal Filter Kit for B Cabinets	5.....	✓
BAYFLTR204	Horizontal Filter Kit for C Cabinets.....	5.....	✓
BAYFLTR205	Horizontal Filter Kit for D Cabinets.....	5.....	✓
BAYVENT600AⓈ.....	Internal venting kit	11.....	✓
BAYVENT800B	Masonry Chimney Vent Kit	11.....	✓
PIP02095.....	U fitting for gas piping.....	1.....	✓
BAYLIFTB.....	Dual return kit. B cabinet size extension	8.....	✓
BAYLIFTC.....	Dual return kit. C cabinet size extension	9.....	✓
BAYLIFTD.....	Dual return kit. D cabinet size extension	9.....	✓
BAYBASE205	Downflow subbase	8.....	✓
BAYFLTR206	Filter Access Door Kit (Downflow only)	2.....	✓
BAYSF1165	16x20 1" side return filter rack.....		✓
BAYSF1255	16x25 1" side return filter rack (bottom return for 17.5" cabinets)		✓
BAYBURNERSS	Stainless steel natural gas burner kit.....		✓

Ⓢ Compatible with B, C, and D width cabinets.

Comfort Controls — See Comfort Controls/Zone Sensors Section

For complete equipment / combination selections, installation instructions and warranty information, please refer to Product Data/Ratings and/or Installers Guides and Limited Warranty Handbooks.



A951X - Single Stage, ECM



A951X
Gas Furnace

Table RTFUR-3-A — A951X Constant Torque ECM, 1 Stage, 95-96% AFUE, Upflow Gas Furnace

Model Number	Input (BTUH)		ICS AFUE ^②	Flue Size (in.)	Ignition Device	Uncrated Dimensions (in.)			Shipping Weight (lbs.)	Max. Fuse*	Filter Sizes
	1st Stage	2nd Stage				H	W	D			
A951X040BU3SAB	40,000		96.0 ^③	2, 3, 4	①	34	17.5	28.75	122	15	16x25x1
A951X060BU4SAB	60,000		96.0 ^③	2, 3, 4	①	34	17.5	28.75	130	15	16x25x1
A951X080BU4SAB	80,000		96.0 ^③	2, 3, 4	①	34	17.5	28.75	135	15	16x25x1
A951X080CU5SAB	80,000		96.0 ^③	2, 3, 4	①	34	21	28.75	149	15	20x25x1
A951X100CU5SAB	100,000		95.0 ^③	2, 3, 4	①	34	21	28.75	155	15	20x25x1
A951X120DU5SAB	120,000		95.0 ^③	3, 4	①	34	24.5	28.75	167	15	24x25x1

Table RTFUR-3-B — A951X Constant Torque ECM, 1 Stage, 95-96% AFUE, Downflow Gas Furnace

Model Number	Input (BTUH)		ICS AFUE ^②	Flue Size (in.)	Ignition Device	Uncrated Dimensions (in.)			Shipping Weight (lbs.)	Max. Fuse*	Filter Sizes
	1st Stage	2nd Stage				H	W	D			
A951X040BD3SAB	40,000		96.0 ^③	2, 3, 4	①	34	17.5	28.75	122	15	(2) 14x20x1
A951X060BD3SAB	60,000		96.0 ^③	2, 3, 4	①	34	17.5	28.75	127	15	(2) 14x20x1
A951X080BD4SAB	80,000		95.0 ^③	2, 3, 4	①	34	17.5	28.75	135	15	(2) 14x20x1
A951X100CD5SAB	100,000		96.0 ^③	2, 3, 4	①	34	21	28.75	155	15	(2) 16x20x1
A951X120DD5SAB	120,000		95.0 ^③	3, 4	①	34	24.5	28.75	167	15	(2) 16x20x1

- ① Silicon Nitride Igniter.
- ② Isolated Combustion System. AFUE may vary based on poise.
- ③ ENERGY STAR®

A952V - Two Stage, Variable Speed ECM



A952V
Gas Furnace

Table RTFUR-3-C — A952V Variable Speed, 2 Stage, 96% AFUE, Upflow Gas Furnace

Model Number	Input (BTUH)		ICS AFUE ^②	Flue Size (in.)	Ignition Device	Uncrated Dimensions (in.)			Shipping Weight (lbs.)	Max. Fuse*	Filter Sizes
	1st Stage	2nd Stage				H	W	D			
A952V040BU3SAC	26,000	40,000	96.0 ^③	2, 3, 4	①	34	17.5	28.75	122	15	16x25x1
A952V060BU3SAC	39,000	60,000	96.0 ^③	2, 3, 4	①	34	17.5	28.75	127	15	16x25x1
A952V060BU4SAC	39,000	60,000	96.0 ^③	2, 3, 4	①	34	17.5	28.75	130	15	16x25x1
A952V080BU4SAC	52,000	80,000	96.0 ^③	2, 3, 4	①	34	17.5	28.75	135	15	16x25x1
A952V080CU5SAC	52,000	80,000	96.0 ^③	2, 3, 4	①	34	21	28.75	149	15	20x25x1
A952V100CU4SAC	65,000	100,000	96.0 ^③	2, 3, 4	①	34	21	28.75	154	15	20x25x1
A952V100CU5SAC	65,000	100,000	96.0 ^③	2, 3, 4	①	34	21	28.75	155	15	20x25x1
A952V120DU5SAC	78,000	120,000	96.0 ^③	3, 4	①	34	24.5	28.75	167	15	24x25x1

Table RTFUR-3-D — A952V Variable Speed, 2 Stage, 96% AFUE, Downflow Gas Furnace

Model Number	Input (BTUH)		ICS AFUE ^②	Flue Size (in.)	Ignition Device	Uncrated Dimensions (in.)			Shipping Weight (lbs.)	Max. Fuse*	Filter Sizes
	1st Stage	2nd Stage				H	W	D			
A952V040BD3SAC	26,000	40,000	96.0 ^③	2, 3, 4	①	34	17.5	28.75	122	15	14x20x1
A952V060BD3SAC	39,000	60,000	96.0 ^③	2, 3, 4	①	34	17.5	28.75	127	15	14x20x1
A952V080BD4SAC	52,000	80,000	96.0 ^③	2, 3, 4	①	34	17.5	28.75	135	15	14x20x1
A952V100CD4SAC	65,000	100,000	96.0 ^③	2, 3, 4	①	34	21	28.75	154	15	16x20x1
A952V100CD5SAC	65,000	100,000	96.0 ^③	2, 3, 4	①	34	21	28.75	155	15	16x20x1
A952V120DD5SAC	78,000	120,000	96.0 ^③	3, 4	①	34	24.5	28.75	167	15	16x20x1

- ① Silicon Nitride Igniter.
- ② Isolated Combustion System. AFUE may vary based on poise.
- ③ ENERGY STAR®
- * Information subject to change. Please confirm with current Product Data/Service Facts for current factory production.



95+% AFUE Furnaces

Table RTFUR-4-A – Features

	A951X Constant Torque	A952V Variable Speed
• AFUE	Up to 96%	96%
• Direct drive, variable speed ECM blower motor - Constant airflow ECM (electronically commutated motor)	—	✓
• Two stage combination gas valve and regulator	—	✓
• Constant Torque Electronically Commutated Motor (ECM)	✓	—
• Single-stage combination gas valve and regulator	✓	—
• 34" cabinet height	✓	✓
• 3 Way poise Upflow furnace model (Upflow, Horizontal Left, Horizontal Right)	✓	✓
• 29–4C Stainless Steel Secondary Heat Exchanger	✓	✓
• Adjustable blower off delay for heating and cooling	✓	✓
• Alternate bottom/left/right return air (upflow models only)	✓	✓
• Bottom panel	✓	✓
• Cabinet has no knockouts - Rubber and plastic plugs come installed from factory	✓	✓
• Condensate can exit either side of cabinet in Upflow orientation	✓	✓
• Dedicated Downflow furnace model	✓	✓
• FER compliant	✓	✓
• Front service access with easily accessible burners, sensors, orifices, switches, and other components	✓	✓
• Gas can enter either side of cabinet	✓	✓
• Gasketed inner and outer door	✓	✓
• Heavy gauge reinforced wrap-around steel cabinet	✓	✓
• Alpha-numeric diagnostic codes	✓	✓
• Last six fault codes are stored (even with power loss)	✓	✓
• Left/right condensate drain capability in vertical application	✓	✓
• Longer IFC wire harnesses allow door to be removed without disconnecting the harness	✓	✓
• Manual reset flame roll out switches	✓	✓
• Meets requirements for 1.4% cabinet air leakage	✓	✓
• Mobile home approved with mobile home kit	✓	✓
• Multiple heating blower speeds	✓	✓
• Multiple venting options - Every model, every size will offer two venting options	✓	✓
• Multi-port in shot burners	✓	✓
• Integrated Furnace Control board with digital configuration, status, and fault codes	✓	✓
• Service diagnostic capabilities	✓	✓
• Service diagnostics with faults reported on IFC board	✓	✓
• Side return duct starter tabs (upflow models only)	✓	✓
• Silicon Nitride 120V hot surface igniter	✓	✓
• Slide out blower assembly on full-length rails	✓	✓
• Tubular Stainless Steel Primary Heat Exchanger	✓	✓
• 5-year functional parts limited warranty/Production Registration Not Required	✓	✓
• 10-year functional parts warranty/product registration required*	✓	✓
• Commercial Applications: Limited Warranty Heat exchangers 20 years. All other functional parts 1 year	✓	✓

* Registered Limited Warranty terms are available when you register within 60 days of installation. You can register online at RunTruHVAC.com or by phone at 855-260-2975, otherwise Trane's Base Limited Warranty terms will apply. Base Limited Warranty information on specific products can be found on ComfortSite.com.

RunTru™
Furnaces



95+% AFUE Furnaces

Table RTSC-5-A – Optional Accessories

Model Number	Description	Shipping Weight	A951X Constant Torque	A952V Variable Speed
BAYLPSS400B.....	LP Kit with Stainless Steel Burners.....	3.....	✓	✓
BAYHANG	Horizontal hanging kit	2.....	✓	✓
BAYVENT200B.....	Sidewall vent Termination Kit fo Direct vent furnaces	2.....	✓	✓
BAYVENTCN200B	Sidewall vent Termination Kit fo Direct vent furnaces for Canadian applications	2.....	✓	✓
BAYAIR30AVENTA	Concentric vent kit for 2, 2½ and 3" vent system	11.....	✓	✓
BAYAIR30CNVENT	Concentric vent kit for 2, 2½ and 3" vent system for Canadian applications	11.....	✓	✓
BAYREDUCE	Reducer Coupling for Canadian applications (CPVC)	1.....	✓	✓
BAYLIFTB.....	Dual return kit. B size extension.....	8.....	✓	✓
BAYLIFTC	Dual return kit. C size extension.....	9.....	✓	✓
BAYLIFTD	Dual return kit. D size extension.....	9.....	✓	✓
BAYMFGH200B.....	Manufactured/mobile home kit	1.....	✓	✓
BAYCNDTRAP2A.....	In-line condensate collector for 2" PVC pipe	1.....	✓	✓
BAYCNDTRAP3A.....	In-line condensate collector for 3" PVC pipe	1.....	✓	✓
BAYBASE205.....	Downflow subbase	8.....	✓	✓
BAYFLTR206.....	Filter Access Door Kit (Downflow only)	2.....	✓	✓
MAYBFERCOLKITAⓈ ...	Heat Shield, B size cabinet	3.....	✓	✓
MAYCFERCOLKITAⓈ ...	Heat Shield, C size cabinet.....	3.....	✓	✓
MAYDFERCOLKITAⓈ ...	Heat Shield, D size cabinet.....	3.....	✓	✓
BAYSF1165.....	16x20 1" side return filter rack		✓	✓
BAYSF1255.....	16x25 1" side return filter rack (bottom return for 17.5" cabinets).....		✓	✓
BAYBURNERSS.....	Stainless steel natural gas burner kit.....		✓	✓

Ⓢ Required on furnaces manufactured on or after 7/3/19 (with date code 19273 or after) when installed with a 4MXC or 4GXC coils in upflow or horizontal position. Not required in Downflow orientation.

ONLINE ONLY





Packaged Cooling Convertible 2-5 Tons



**4TCA4
1-Phase**

Table RTPK-1-A – 13.4 SEER2 - 4TCA4 Convertible Packaged Cooling - R-410A

Model Number	Cooling Capacity (BTUH) ①	SEER2/EER2	Shipping Weight (lbs.)	MCA ②	Max. Fuse	Sound Rating	Shipping Dimensions (in.)
4TCA4 (13.4 SEER2) - 208-230/1/60							
4TCA4024C1000A	23,000	13.40/10.60	364	17.0	25	77.0	41 x 37 x 62
4TCA4030C1000A	27,800	13.40/10.60	364	20.0	30	77.0	41 x 37 x 62
4TCA4036C1000A	35,000	13.40/10.60	380	26.0	40	79.0	41 x 37 x 62
4TCA4042C1000A	39,500	13.40/10.60	430	31.0	50	79.0	41 x 37 x 62
4TCA4048C1000A	45,500	13.40/10.60	530	32.0	50	79.0	46 x 37 x 62
4TCA4060C1000A	57,000	13.40/10.60	551	38.0	60	78.0	46 x 37 x 62

① Rated in accordance with AHRI Standard 210/240.

② Calculated in accordance with currently prevailing Nat'l Electrical Code.

ONLINE ONLY COPY



Packaged Cooling Convertible 2-5 Tons

Table RTPK-2-A — Features

	4TCA4
• SEER2 up to	13.40
• All-aluminum coil.....	2-4
• Copper Tube/Aluminum Fin indoor coil (5-Ton only)	5
• Ease of installation with small footprint.....	✓
• Designed to accommodate manufactured homes	✓
• Fits low lot lines	✓
• 10-year compressor & coil, 5-year all other functional parts limited warranty with registration* (Residential Use).....	✓
• Extended warranties available.....	✓

* Registered Limited Warranty terms are available when you register within 60 days of installation. You can register online at RunTruHVAC.com or by phone at 855-260-2975, otherwise Trane's Base Limited Warranty terms will apply. Base Limited Warranty information on specific products can be found on ComfortSite.com.

Table RTPK-2-B — Optional Accessories

Model Number	Description	Used with Accessory	
BAYUTIL103A	Through the Base Utilities Curb Extension		2-5
BAYCCHT102A.....	Crankcase Heater		3.5-5
BAYCCHT103A.....	Crankcase Heater		3
BAYLOAM105A	Low Ambient Cooling Control Kit		2-5
BAYQSTK301AB	Quick Start Kit.....		3-5
BAYSQRD001A.....	Square to Round Adaptor Kit.....		2-3
BAYSQRD002A.....	Square to Round Adaptor Kit.....		3.5-5
BAYEXMK001A.....	Extreme Condition Mounting Kit	BAYCURB	2-5
BAYEXMK002B	Extreme Condition Mounting Kit.....	BAYUTIL	2-5
BAYEXMK003A.....	Extreme Condition Mounting Kit.....	Used on slab mounts.....	2-5
BAYSPEK071	Single Power Entry Kit.....	BAYHTR1V15, BAYHTR1V20	2.5-5
BAYSPEK072.....	Single Power Entry Kit.....	BAYHTR1V05, BAYHTR1V08, BAYHTR1V10	2-5

Model Number	Description	Matched with Accessory Heater	4TCA4
BAYSPEK071	Single Power Entry Kit	BAYHTR1V15	2.5-5
		BAYHTR1V20	4-5
BAYSPEK072	Single Power Entry Kit	BAYHTR1V05	2-5
		BAYHTR1V08	2-5
		BAYHTR1V10	2-5

Electric Heaters

Model Number	Description	4TCA4
BAYHTR1V05LUGA	5 KW Heater	2-5
BAYHTR1V08LUGA	8 KW Heater	2-5
BAYHTR1V10LUGA	10 KW Heater	2-5
BAYHTR1V15BRKA	15 KW Heater	2.5-5
BAYHTR1V20BRKA	20 KW Heater	4-5

Comfort Controls — See Comfort Controls/Zone Sensors Section

For complete equipment / combination selections, installation instructions and warranty information, please refer to Product Data/Ratings and/or Installers Guides and Limited Warranty Handbooks.



Packaged Heat Pump Convertible 2-5 Tons



**4WCA4
1-Phase**

Table RTPK-3-A — 13.4 SEER2 - 4WCA4 Convertible Packaged Heat Pump - R-410A

Model Number	Cooling Capacity (BTUH)	Heating Capacity (BTUH)	SEER2/EER2	HSPF2	Shipping Weight (lbs.)	MCA	Max. Fuse	Sound Rating	Shipping Dimensions (in.)
4WCA4 (13.4 SEER2) - 208-230/1/60									
4WCA4024C1000A	23,600	23,000	13.40/10.60	6.7	455	22.0	35	75.6	41 x 37 x 62
4WCA4030C1000A	29,000	26,400	13.40/10.60	6.7	455	24.0	35	78.8	41 x 37 x 62
4WCA4036C1000A	34,200	30,200	13.40/10.60	6.7	475	25.0	35	79.3	41 x 37 x 62
4WCA4042C1000A	41,000	37,400	13.40/10.60	6.7	485	33.0	50	79.3	41 x 37 x 62
4WCA4048C1000A	46,500	44,500	13.40/10.60	6.7	505	35.0	50	78.7	46 x 37 x 62
4WCA4060C1000A	56,000	53,500	13.40/10.60	6.7	505	42.0	60	78.8	46 x 37 x 62

ONLINE ONLY COPY

For complete equipment / combination selections, installation instructions and warranty information, please refer to Product Data/Ratings and/or Installers Guides and Limited Warranty Handbooks.



Packaged Heat Pump Convertible 2-5 Tons

Table RTPK-4-A – Features

	4WCA4
• SEER2 up to	13.40
• Copper Tube/Aluminum Fin outdoor coil	2-5
• Ease of installation with small footprint	✓
• Designed to accommodate manufactured homes	✓
• Fits low lot lines	✓
• 10-year compressor & coil, 5-year all other functional parts limited warranty with registration* (Residential Use)	✓
• Extended warranties available	✓

* Registered Limited Warranty terms are available when you register within 60 days of installation. You can register online at RunTruHVAC.com or by phone at 855-260-2975, otherwise Trane's Base Limited Warranty terms will apply. Base Limited Warranty information on specific products can be found on ComfortSite.com.

Table RTPK-4-B – Optional Accessories

Model Number	Description	Used with Accessory	
BAYCURB060A.....	Flat Roof Full Perimeter Curb.....		2-5
BAYUTIL103A.....	Roof Curb Utility Extension Kit		2-5
BAYCCHT102A.....	Crankcase Heater		3.5-5
BAYCCHT103A.....	Crankcase Heater		2-3
BAYLOAM105A.....	Low Ambient Control Kit		2-5
TAYSTAT250C.....	Outdoor Thermostat Kit.....		2-5
BAYQSTK301A.....	Start Kit (Scroll)		2-5
BAYSQRD001B.....	16" Round Duct Adapter		2-3
BBAYSQRD002B.....	18" Round Duct Adapter		3.5-5
BAYEXMK001A.....	Extreme Condition Mounting Kit.....	BAYCURB	2-5
BAYEXMK002B.....	Extreme Condition Mounting Kit.....	BAYUTIL	2-5
BAYEXMK003A.....	Extreme Condition Mounting Kit.....	Slab mounting.....	2-5

Model Number	Description	Matched with Accessory Heater	4WCA4
BAYSPEK070A	Single Power Entry Kit	BAYHTR1V05	3.5-5
		BAYHTR1H08	2-5
		BAYHTR1H10	2-5
BAYSPEK071A	Single Power Entry Kit	BAYHTR1H15	3-5
		BAYHTR1H20	5
BAYSPEK072A	Single Power Entry Kit	BAYHTR1V05	2-3

Electric Heaters

Model Number	Description	4WCA4
BAYHTR1V05LUGA	Electric heater 5 KW	2-5
BAYHTR1H08LUGA	Electric heater 7.5 KW	2-5
BAYHTR1H10LUGA	Electric heater 10 KW	2-5
BAYHTR1H15BRKA	Electric heater 15 KW	2.5-5
BAYHTR1H20BRKA	Electric heater 20 KW	4-5

Comfort Controls – See Comfort Controls/Zone Sensors Section

For complete equipment / combination selections, installation instructions and warranty information, please refer to Product Data/Ratings and/or Installers Guides and Limited Warranty Handbooks.



It's Hard To Stop A Trane.®

Odyssey with Symbio™ Cooling Split Systems Single Circuit, Three Phase – 6-25 Tons, R-410A

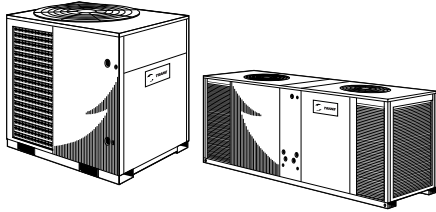

TTA – 6-25 Tons

- Symbio™ controls option
- (1) Scroll compressor (TTA072-120A)
- (2) Scroll compressors (TTA072-240D) with independent refrigerant circuits
- Single point power
- Compressor motor overload protection
- Compressor discharge temperature limit switch
- Control transformer
- High and low pressure cut-out switches
- Liquid line filter drier, factory installed
- Electrical phase reversal protection
- Internal pressure relief valves
- Holding charge (Dry Nitrogen)
- All Aluminum microchannel coil
- Low ambient cooling to 50°F as shipped
- Low ambient cooling to 0°F with accessory head pressure control
- Mounting/lifting rails under base
- UL listed
- 5-year compressor warranty
- 1-year limited parts warranty
- Optional Extended Warranties

Model Number Description – Cooling Condenser

Digit 1–3 – Unit Function
TTA = Split System Cooling

Digit 4–6 – Tonnage
072 = 6 Tons (60Hz)
090 = 7.5 Tons (60Hz)
120 = 10 Tons (60Hz)
150 = 12.5 Tons (60Hz)
180 = 15 Tons (60Hz)
240 = 20 Tons (60Hz)
300 = 25 Tons (60Hz)

Digit 7 – Refrigerant
4 = R-410A

Digit 8 – Voltage
3 = 208-230VAC - 3 PH (60Hz)
4 = 460VAC - 3 PH (60Hz)
W = 575VAC - 3 PH (60Hz)

Digit 9 – Refrigeration Circuit/Stage
A = 1 Compressor/1 Line/1 Stage (Single)
C = 2 Compressors/1 Line/2 Stage (Manifold)

Digit 10 – Major Design Sequence
A = Current Design Sequence

Digit 11 – Minor Design Sequence
A = Current Design Sequence

Digit 12–13 – Service Digits

Digit 14 – Efficiency Generation
B = Generation B

Digit 15 – Controls
S = Symbio™

Digit 16 – None
0 = Not Used

Digit 17 – Coil Protection

1 = Standard Coil w/ Hail Guard
5 = Complete Coat Condenser Coil with Hail Guard (MCHE)

Digit 18-20 – None
0 = Not Used

Digit 21 – Communications Options

0 = No Option
1 = BACnet® BAS Communications
2 = LonTalk® Communications Interface (LCI)

Digit 22-40 – None
0 = Not Used

Table LSC-1-A – TTA Split System Cooling – Single Compressor – R-410 Refrigerant

Model Number	Power Supply	AHRI Net Cooling Cap. (BTUH)	Uncrated Dimensions(in.)			Shipping Weight (lbs.)	Sound [Ⓢ] Rating	MCA*	Max. Fuse*	Connection Size (in)	
			H	W	L					OD Gas	OD Liq.
TTA07243A	208-230/3/60	76,000	46	45	38	324	84	28	45	1 ¹ / ₈	1 ¹ / ₂
TTA09043A	208-230/3/60	95,000	45	45	38	342	83	34	60	1 ³ / ₈	1 ¹ / ₂
TTA07244A	460/3/60	76,000	46	45	38	324	84	12	20	1 ¹ / ₈	1 ¹ / ₂
TTA09044A	460/3/60	95,000	45	45	38	342	83	17	25	1 ³ / ₈	1 ¹ / ₂
TTA0724WA	575/3/60	76,000	46	45	38	324	84	9	15	1 ¹ / ₈	1 ¹ / ₂
TTA0904WA	575/3/60	95,000	45	45	38	342	83	13	20	1 ³ / ₈	1 ¹ / ₂

Table LSC-1-B – TTA Split System Cooling – Dual Manifolder Compressors with Single Refrigerant Circuits – R-410 Refrigerant

Model Number	Power Supply	AHRI Net Cooling Cap. (BTUH)	Uncrated Dimensions(in.)			Shipping Weight (lbs.)	Sound [Ⓢ] Rating	MCA*	Max. Fuse*	Connection Size (in)	
			H	W	L					OD Gas	OD Liq.
TTA12043C	208-230/3/60	122,000	45	55	42	473	91	41	50	1 ³ / ₈	1 ¹ / ₂
TTA18043C	208-230/3/60	184,000	51.1	96	48	806	93	67	90	1 ⁵ / ₈	5 ⁵ / ₈
TTA24043C	208-230/3/60	250,000	51.1	96	48	879	94	98	125	1 ⁵ / ₈	5 ⁵ / ₈
TTA30043C	208-230/3/60	296,000	57.1	96	48	1013	94	102	125	2 ¹ / ₈	5 ⁵ / ₈
TTA12044C	460/3/60	122,000	45	55	42	473	91	20	25	1 ³ / ₈	1 ¹ / ₂
TTA18044C	460/3/60	188,000	51.1	96	48	806	93	32	40	1 ⁵ / ₈	5 ⁵ / ₈
TTA24044C	460/3/60	250,000	51.1	96	48	879	94	47	60	1 ⁵ / ₈	5 ⁵ / ₈
TTA30044C	460/3/60	296,000	57.1	96	48	1013	94	49	60	2 ¹ / ₈	5 ⁵ / ₈
TTA1204WC	575/3/60	122,000	45	55	42	473	91	15	20	1 ³ / ₈	1 ¹ / ₂
TTA1804WC	575/3/60	184,000	51.1	96	48	806	93	37	50	1 ⁵ / ₈	5 ⁵ / ₈
TTA2404WC	575/3/60	250,000	51.1	96	48	879	94	39	50	1 ⁵ / ₈	5 ⁵ / ₈
TTA3004WC	575/3/60	297,000	57.1	96	48	1013	94	42	50	2 ¹ / ₈	5 ⁵ / ₈

Ⓢ Sound rating shown is tested in accordance with ARI Standard 270 or 370.

* Information subject to change. Please confirm with current Product Data/Service Facts for current factory production.

For complete equipment / combination selections, installation instructions and warranty information, please refer to Product Data/Ratings and/or Installers Guides and Limited Warranty Handbooks.



It's Hard To Stop A Trane.®

Odyssey with Symbio™ Cooling Split Systems Dual Circuit, Three Phase – 6-25 Tons, R-410A

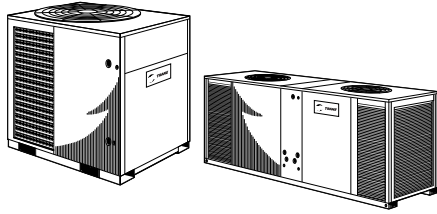

TTA – 6-25 Tons

- Symbio™ controls option
- (2) Manufactured scroll compressors
- Single point power
- Compressor motor overload protection
- Compressor discharge temperature limit switch
- Control transformer
- High and low pressure cut-out switches
- Liquid line filter drier, factory installed
- Electrical phase reversal protection
- Internal pressure relief valves
- Holding charge (Dry Nitrogen)
- All aluminum microchannel coil
- Low ambient cooling to 50°F as shipped
- Low ambient cooling to 0°F with accessory head pressure control
- Mounting/lifting rails under base
- UL listed
- 5-year compressor warranty
- 1-year limited parts warranty
- Optional Extended Warranties

Model Number Description – Cooling Condenser

Digit 1-3 – Unit Function
TTA = Split System Cooling

Digit 4-6 – Tonnage
072 = 6.0 Tons (60Hz)
090 = 7.5 Tons (60Hz)
120 = 10 Tons (60Hz)
180 = 15 Tons (60Hz)
240 = 20 Tons (60Hz)

Digit 7 – Refrigerant
4 = R410A

Digit 8 – Voltage
3 = 208-230VAC - 3 PH (60Hz)
4 = 460VAC - 3 PH (60Hz)
W = 575VAC - 3 PH (60Hz)

Digit 9 – Refrigeration Circuit/Stage
D = 2 Compressors/2 Line/2 Stage (Duals)

Digit 10 – Major Design Sequence
A = Current Design Sequence

Digit 11 – Minor Design Sequence
A = Current Design Sequence

Digit 12-13 – Service Digits

Digit 14 – Efficiency Generation
B = Generation B

Digit 15 – Controls
S = Symbio™

Digit 16 – None
0 = Not Used

Digit 17 – Coil Protection
1 = Standard Coil with Hail Guard
5 = Complete Coat Condenser Coil with Hail Guard (MSHE)

Digit 18-20 – None
0 = Not Used

Digit 21 – Communications Options
1 = BACnet® BAS Communications
2 = LonTalk® Communications Interface (LCI)

Digit 22-40 – None
0 = Not Used

Table LSC-2-B – TTA Split System Cooling – Dual Compressors with Two Sets of Refrigerant Circuits - R-410 Refrigerant

Model Number	Power Supply	AHRI Net Cooling Cap. (BTUH)	Uncrated Dimensions(in.)			Shipping Weight (lbs.)	Sound [Ⓞ] Rating	MCA*	Max. Fuse*	Connection Size (in)	
			H	W	L					OD Gas	OD Liq.
TTA07243D	208-230/3/60	75,000	45	45	38	344	91	23	30	7/8	1/2
TTA09043D	208-230/3/60	93,000	45	45	38	380	91	33	45	1 1/8	1/2
TTA12043D	208-230/3/60	116,000	45	55	42	436	91	41	50	1 1/8	1/2
TTA15043D	208-230/3/60	150,000	52.1	55	42	504	93	55	70	1 1/8	1/2
TTA18043D	208-230/3/60	186,000	51.1	96	48	806	93	66	90	1 3/8	1/2
TTA24043D	208-230/3/60	246,000	51.1	96	48	872	94	87	110	1 3/8	1/2
TTA07244D	460/3/60	75,000	45	45	38	344	91	14	20	7/8	1/2
TTA09044D	460/3/60	91,000	45	45	38	380	91	15	20	1 1/8	1/2
TTA12044D	460/3/60	116,000	45	55	42	436	91	20	25	1 1/8	1/2
TTA15044D	460/3/60	155,000	52.1	55	42	504	93	26	35	1 1/8	1/2
TTA18044D	460/3/60	193,000	51.1	96	48	806	93	32	40	1 3/8	1/2
TTA24044D	460/3/60	246,000	51.1	96	48	872	94	40	50	1 3/8	1/2
TTA0724WD	575/3/60	75,000	45	45	38	344	91	10	15	7/8	1/2
TTA0904WD	575/3/60	93,000	45	45	38	380	91	11	15	1 1/8	1/2
TTA1204WD	575/3/60	116,000	45	55	42	436	91	14	15	1 1/8	1/2
TTA1504WD	575/3/60	150,000	52.1	55	42	504	93	19	25	1 1/8	1/2
TTA1804WD	575/3/60	186,000	51.1	96	48	806	93	25	30	1 3/8	1/2
TTA2404WD	575/3/60	246,000	51.1	96	48	872	94	31	40	1 3/8	1/2

Ⓞ Sound rating shown is tested in accordance with ARI Standard 270 or 370.

* Information subject to change. Please confirm with current Product Data/Service Facts for current factory production.

Light Commercial
Split System Cooling

For complete equipment / combination selections, installation instructions and warranty information, please refer to Product Data/Ratings and/or Installers Guides and Limited Warranty Handbooks.



It's Hard To Stop A Trane.®

Odyssey with Symbio™ Cooling Split Systems - R410A - 6-25 Ton Condenser Accessories

Table LSC-3-A — TTA Accessories

Model	Used With
Universal Hot Gas Bypass Kit	
BAYHGBP010*	All models
Rubber Isolators	
BAYISLT004* (blue)	TTA072, TTA090
BAYISLT005* (black)	TTA120
BAYISLT009* (red)	TTA150, TTA180
BAYISLT010* (green)	TTA240, TTA300
Steel Spring Isolators	
BAYISLT023* (red)	TTA072, TTA090, TTA120**A
BAYISLT024* (black)	TTA120**C/D, TTA150, TTA180
BAYISLT025* (yellow)	TTA240, TTA300
Service Valve Kit	
BAYVALV001	TTA0724*A, TTA0904*A, TTA1204*C
BAYVALV003	TTA0724*D, TTA0904*D, TTA1204*D
BAYVALV004	TTA1504*D
BAYVALV005	TTA1804*D, TTA2404*D
BAYVALV007	TTA1804*C, TTA2404*C
BAYVALV008	TTA3004*C
Low Ambient — On/Off Fan Control (External mount, small cabinets)① ② ③	
BAYLOAMS10* (External Mount, small cabinets)④	(all voltages) TTA072, TTA090
BAYLOAMS20* (Internal mount, large cabinets)	(all voltages) TTA120, TTA150, TTA180, TTA240, TTA300
Transducer Kit for Head Pressure Control (BAYLOAM10*)	
BAYLOTR001*④	TTA120**D, TTA150**D
LonTalk Communications Interface⑤	
BAYLTCI005*	All Models
Expansion Module Kit	
BAYMODU002* (XM30)	All Models
BAYMODU004* (XM32)	All Models

① Cycles fan on/off (no modulating).

② When BAYLOAM is used, the Evaporator Defrost Control (EDC) must be disabled in the Symbio 700 controller configuration.

③ Kit mounts external to the outdoor unit and operates by sensing ambient and liquid line temperatures.

④ BAYLOTR001* is required when BAYLOAMS10* kits are used with units that have 2 compressors (dual circuit) and 1 condenser fan.

⑤ Field installed LonTalk interface requires installation of Symbio control board with Advanced Diagnostics (not included).



It's Hard To Stop A Trane.®

Split System Cooling Three Phase – 6-25 Tons

Table LSC-4-A – Symbio™ Control Options

Model Number	Description	Used With
BAYSENS107	Zone Sensor, Set Point Adj, Fan, System, EH, ED	TTA072-TTA300 with Symbio™ Controls
BAYSENS109	Zone Sensor, 2 Set Point Adj, Fan, System, EH, ED	TTA072-TTA300 with Symbio™ Controls
BAYSENS119	Digital Programmable Zone Sensor	TTA072-TTA300 with Symbio™ Controls
BAYSENS135	Digital Non-Programmable Zone Sensor	TTA072-TTA300 with Symbio™ Controls
BAYSENS106	Zone Sensor, Set Point, Fan, System	TTA072-TTA300 with Symbio™ Controls
BAYSENS108	Zone Sensor, 2 Set Point, Fan, System	TTA072-TTA300 with Symbio™ Controls
BAYSENS110	Zone Sensor, 2 Set Point, Fan, System, ED	TTA072-TTA300 with Symbio™ Controls

Table LSC-4-B – Electromechanical Control Options

Model Number	Description	Used With
TCONT102AN11AA	1H/1C Non-Programmable Thermostat	TTA072A, TTA090A
TCONT103AN21HA	2H/1C Non-Programmable Thermostat	TTA072A, TTA090A
TCONT402AN32DA	3H/2C Non-Programmable Thermostat	ALL
TCONT202AS11MA	1H/1C Programmable Thermostat	TTA072A, TTA090A
TCONT302AS42DA	4H/2C Touchscreen Programmable Thermostat	ALL
TCONT303AS42DA	4H/2C Touchscreen Programmable Thermostat, Humidity Sensor	ALL
BAYSTAT814A	Picot Smart Thermostat	ALL

ONLINE ONLY



It's Hard To Stop A Trane.®

Odyssey with Symbio™ Heat Pumps Three Phase - 6-20, R-410A

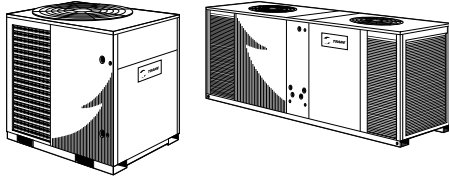

TWA – 6-20 Tons

- Symbio™ controls (standard)
- (1) Scroll compressor (TWA072-120A)
- (2) Scroll compressors (TWA072-240D) with independent refrigerant circuits
- Single point power
- Compressor motor overload protection
- Compressor discharge temperature limit switch
- Control transformer
- High and low pressure cut-out switches
- Demand Defrost Control
- Internal pressure relief valves
- Electrical phase reversal protection
- Holding charge (Dry Nitrogen)
- Copper tube, aluminum plate fin coils
- Low ambient cooling to 50°F as shipped
- Low ambient cooling to 0°F with accessory head pressure control
- Mounting/lifting rails under base
- UL listed
- 5-year compressor warranty
- 1-year limited parts warranty
- Optional Extended Warranties

Model Number Description – Heat Pump Condenser

Digit 1-3 – Unit Function
TWA = Split System Heat Pump

Digit 4-6 – Tonnage

072 = 6 Tons (60Hz)

090 = 7.5 Tons (60Hz)

120 = 10 Tons (60Hz)

180 = 15 Tons (60Hz)

240 = 20 Tons (60Hz)

Digit 7 – Refrigerant

4 = R-410A

Digit 8 – Voltage

3 = 208-230VAC - 3 PH (60Hz)

4 = 460VAC - 3 PH (60Hz)

W = 575VAC - 3 PH (60Hz)

K = 380VAC - 3 PH (60Hz)

Digit 9 – Refrigeration Circuit/Stage

A = 1 Compressor/1 Line/1 Stage (Single)

D = 2 Compressors/2 Line/2 Stage (Duals)

Digit 10 – Major Design Sequence

A = Current Design Sequence

Digit 11 – Minor Design Sequence

A = Current Design Sequence

Digit 12-13 – Service Digits

Digit 14 – Efficiency Generation

B = Generation B

Digit 15 – Controls

S = Symbio™

Digit 16 – None

0 = Not Used

Digit 17 – Coil Protection

1 = Standard Coil w/ Hail Guard

3 = Black Epoxy Pre-Coated Condenser Coil with Hail Guard (FIN/TUBE)

Digit 18-20 – None

0 = Not Used

Digit 21 – Communications Options

0 = No Option

1 = BACnet® BAS Communications

2 = LonTalk® Communications Interface (LCI)

Digit 22-40 – None

0 = Not Used

Table LSH-1-A – TWA Split System Heat Pumps – Single Compressor with Single Refrigerant Circuits – R-410 Refrigerant

Model Number	Power Supply	AHRI Net Cooling Cap. (BTUH)	Uncrated Dimensions(in.)			Shipping Weight (lbs.)	Sound [Ⓢ] Rating	MCA*	Max. Fuse*	Connection Size (in)	
			H	W	L					OD Gas	OD Liq.
TWA07243A	208-230/3/60	78,000	45	45	38	360	84	31	50	1 ³ / ₈	1/2
TWA09043A	208-230/3/60	90,000	45	45	38	382	83	34	50	1 ³ / ₈	1/2
TWA12043A	208-230/3/60	123,000	52.1	55	42	495	90	46	70	1 ³ / ₈	1/2
TWA07244A	460/3/60	78,000	45	45	38	360	84	15	25	1 ³ / ₈	1/2
TWA09044A	460/3/60	90,000	45	45	38	382	83	18	30	1 ³ / ₈	1/2
TWA12044A	460/3/60	123,000	52.1	55	42	495	90	25	40	1 ³ / ₈	1/2
TWA0724WA	575/3/60	78,000	45	45	38	360	84	11	15	1 ³ / ₈	1/2
TWA0904WA	575/3/60	90,000	45	45	38	382	83	13	20	1 ³ / ₈	1/2
TWA1204WA	575/3/60	123,000	52.1	55	42	495	90	22	35	1 ³ / ₈	1/2

Table LSH-1-B – TWA Split System Heat Pumps – Dual Compressors with Two Sets of Refrigerant Circuits – R-410 Refrigerant

Model Number	Power Supply	AHRI Net Cooling Cap. (BTUH)	Uncrated Dimensions(in.)			Shipping Weight (lbs.)	Sound [Ⓢ] Rating	MCA*	Max. Fuse*	Connection Size (in)	
			H	W	L					OD Gas	OD Liq.
TWA07243D	208-230/3/60	77,000	45	55	42	413	84	27	35	7/8	1/2
TWA09043D	208-230/3/60	94,000	45	55	42	466	83	33	45	1 ¹ / ₈	1/2
TWA12043D	208-230/3/60	120,000	52.1	55	42	478	90	46	70	1 ¹ / ₈	1/2
TWA18043D	208-230/3/60	192,000	51.1	96	48	874	93	66	90	1 ¹ / ₈	1/2
TWA24043D	208-230/3/60	250,000	51.1	96	48	1003	94	86	110	1 ³ / ₈	5/8
TWA07244D	460/3/60	77,000	45	55	42	413	84	15	20	7/8	1/2
TWA09044D	460/3/60	94,000	45	55	42	466	83	15	20	1 ¹ / ₈	1/2
TWA12044D	460/3/60	120,000	52.1	55	42	478	90	20	25	1 ¹ / ₈	1/2
TWA18044D	460/3/60	192,000	51.1	96	48	874	93	32	40	1 ¹ / ₈	1/2
TWA24044D	460/3/60	250,000	51.1	96	48	1003	94	46	60	1 ³ / ₈	5/8
TWA0724WD	575/3/60	77,000	45	55	42	413	84	10	15	7/8	1/2
TWA0904WD	575/3/60	94,000	45	55	42	466	83	11	15	1 ¹ / ₈	1/2
TWA1204WD	575/3/60	120,000	52.1	55	42	478	90	15	20	1 ¹ / ₈	1/2
TWA1804WD	575/3/60	192,000	51.1	96	48	874	93	25	30	1 ³ / ₈	1/2
TWA2404WD	575/3/60	250,000	51.1	96	48	1003	94	35	45	1 ³ / ₈	5/8

Ⓢ Sound rating shown is tested in accordance with ARI Standard 270 or 370.

* Information subject to change. Please confirm with current Product Data/Service Facts for current factory production.

For complete equipment / combination selections, installation instructions and warranty information, please refer to Product Data/Ratings and/or Installers Guides and Limited Warranty Handbooks.



It's Hard To Stop A Trane.®

Odyssey with Symbio™ Heat Pump Accessories Three Phase – 6-20 Tons, R-410A

Light Commercial Split System Heat Pumps

Table LSH-2-A – TWA Accessories

Model	Used With
Rubber Isolators	
BAYISLT005* (black)	TWA072, TWA090, TWA120
BAYISLT009* (red)	TWA180
BAYISLT010* (green)	TWA240
Steel Spring Isolators	
BAYISLT023* (red)	TWA072, TWA090, TWA120
BAYISLT024* (black)	TWA180
BAYISLT025* (yellow)	TWA240
Service Valve Kit	
BAYVALV001*	TWA0724*A, TWA1204*A
BAYVALV002*	TWA0904*A
BAYVALV003*	TWA0724*D, TWA0904*D, TWA1204*D
BAYVALV006*	TWA01804*D, TWA2404*D
Low Ambient – On/Off Fan Control (External mount, small cabinets)① ② ③	
BAYLOAMS10** (External Mount, small cabinets)④	(all voltages) TWA072**A, TWA090**A
BAYLOAMS20* (Internal mount, large cabinets)	(all voltages) TWA120, TWA180, TWA240
Transducer Kit for Head Pressure Control (BAYLOAM335, 336, 435, 436, W36)	
BAYLOTR001*⑤	TWA072**D, TWA090**D, TWA120**D
LonTalk Communications Interface⑥	
BAYLTCI005*	All Models

- ① Cycles fan on/off (no modulating).
- ② When BAYLOAM is used, the Evaporator Defrost Control (EDC) must be disabled in the Symbio 700 controller configuration.
- ③ Kit mounts external to the outdoor unit and operates by sensing ambient and liquid line temperatures.
- ④ BAYLOTR001* required when modulating BAYLOAMS10* kits used with units that have 2 compressors (dual circuit) and 1 condenser fan.
- ⑤ BAYLOTR001 required when modulating BAYLOAM kits used with units that have 2 compressors (dual circuit) and 1 condenser fan.
- ⑥ Field Installed LonTalk interface requires installation of Symbio control board with Advanced Diagnostic (not included).

Table LSH-2-B – Controls

Model Number	Description	Used With
BAYLTCI005*	LonTalk® Communication Interface (LCI)	TWA072-TWA240



It's Hard To Stop A Trane.®

Odyssey with Symbio™ Air Handlers

Single Phase - 5, 7.5, and 10 Tons, R-410A

Three Phase – 5-25 Tons, R-410A

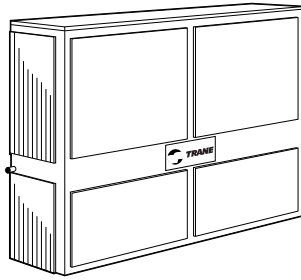

**TWE - 5-25 Ton
Convertible Air Handlers
(Upflow or Horizontal Only)**

- Ships in horizontal configuration, but quickly and easily converts to upflow
- Expansion valve factory installed
- Check valves for heat pump applications
- Belt drive blower
- Factory installed motor, belt, sheaves, contactor, low voltage terminal board
- One inch filters on 5 to 10 ton units (rack convertible for field supplied two inch)
- Captive screws remain on the panels for service ease
- Low voltage terminal board
- Drain Pan
- Factory Installed (EDC) Evaporator Defrost Control
- IAQ (Indoor Air Quality) sloped/free draining pan, no standing water
- Two inch filters factory installed on 12½, 15, 20, 25 ton units
- Supplemental heaters (electric, water, steam) fits directly on unit discharge for low installation cost
- Single point power entry for reduced electrical power installation cost
- Unit fully assembled to reduce field installation costs
- Compact design with low service clearance to reduce building requirements
- Brazed refrigerant piping connections
- Fan relay UL listed and CSA Certified
- Factory installed 2 speed variable frequency drive (VFD) option available for enhanced part load performance and REQUIRED for CA Title 24 Compliance ©
- Factory installed Single Zone VAV (SZVAV) option available for enhanced part load performance and space temperature control via varying airflow ©
- Optional extended warranties

Model Number Description – Cooling Condenser

Digit 1-3 – Unit Function

TWE = Air Handler

Digit 4-6 – Tonnage

060 = 5 Tons (60Hz)
072 = 6 Tons (60Hz)
090 = 7.5 Tons (60Hz)
120 = 10 Tons (60Hz)
150 = 12.5 Tons (60Hz)
180 = 15 Tons (60Hz)
240 = 20 Tons (60Hz)
300 = 25 Tons (60Hz)

Digit 7 – Refrigerant

4 = R-410A

Digit 8 – Voltage

3 = 208-230VAC - 3 PH (60Hz)
4 = 460VAC - 3 PH (60Hz)
W = 575VAC - 3 PH (60Hz)

Digit 9 – Refrigeration Circuit/Stage

A = Single Circuit
B = Dual Circuit

Digit 10 – Major Design Sequence

A = Current Design Sequence

Digit 11 – Minor Design Sequence

A = Current Design Sequence

Digit 12-13 – Service Digits

00 = 00

Digit 14 – Efficiency Generation

B = Generation B

Digit 15 – Controls

1 = Constant Volume
C = 2 Stage Airflow (Electromechanical™ Condenser Only)
D = 2 Stage Airflow/Single Zone VAV (Symbio™ Condenser Only)

Digit 16 – Indoor Fan Sizes

0 = Standard Motor
4 = High Static – (Oversized Motor for VFD Units)

Digit 17-40 – None

0 = None

Table LAH-1-A – Single Circuit Coil - R-410A ©

Tons	Unit Model No.	Power Supply Volts/Phase/Hz	FCCV	"Drive Type"	"Dimensions (in) H x W x D" ①	"Shipping Weight (lbs)"	MCA*	Max Fuse Size or Max Circuit Breaker ②*
Single Phase								
5	TWE06041A	208-230/1/60	TXV	Belt	48 x 39 x 23	285	8	15
7 ½	TWE09041A ③	208-230/1/60	TXV	Belt	54 x 49 x 26	385	8	15
10	TWE12041A ③	208-230/1/60	TXV	Belt	54 x 65 x 26	441	11	15
Three Phase								
5	TWE06043A	208-230/3/60	TXV	Belt	48 x 39 x 23	285	3	15
5	TWE06044A	460/3/60	TXV	Belt	48 x 39 x 23	285	2	15
5	TWE0604WA	575/3/60	TXV	Belt	48 x 39 x 23	285	2	15
7 ½	TWE09043A ③④	208-230/3/60	TXV	Belt	54 x 49 x 26	385	7	15
7 ½	TWE0904WA ③	575/3/60	TXV	Belt	54 x 49 x 26	385	2	15
10	TWE12043A ③④	208-230/3/60	TXV	Belt	54 x 65 x 26	441	9	15
10	TWE1204WA ③	575/3/60	TXV	Belt	54 x 65 x 26	441	3	15

① Control transformer not included. Order control transformer accessory when matching these air handlers with 3-5 ton condensing units.

② Ships wired for 208-230/3/60. Field convertible to 460/3/60.

③ HACR type circuit breaker per NEC.

④ Dimensions based on Upflow position.

⑤ All air handlers are shipped with the drain pan installed in the horizontal position. For vertical configuration, the drain pan should be repositioned before setting the air handler.

* Information subject to change. Please confirm with current Product Data/Service Facts for current factory production.

For complete equipment / combination selections, installation instructions and warranty information, please refer to Product Data/Ratings and/or Installers Guides and Limited Warranty Handbooks.

LAH-1

Effective 1/1/23
22-8301-36



It's Hard To Stop A Trane.®

Odyssey with Symbio™ Air Handlers

Single Phase - 5, 7.5, and 10 Tons, R-410A

Three Phase - 5-25 Tons, R-410A

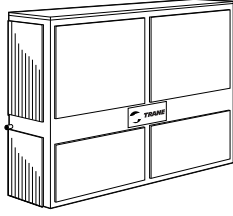

TWE - 5-25 Ton Convertible Air Handlers (Upflow or Horizontal Only)

- Ships in horizontal configuration, but quickly and easily converts to upflow
- Expansion valve factory installed
- Check valves for heat pump applications

- Belt drive blower
- Factory installed motor, belt, sheaves, contactor, low voltage terminal board
- One inch filters on 5 to 10 ton units (rack convertible for field supplied two inch)
- Captive screws remain on the panels for service ease
- Low voltage terminal board
- Drain Pan
- Factory Installed (EDC) Evaporator Defrost Control
- IAQ (Indoor Air Quality) sloped/free draining pan, no standing water
- Two inch filters factory installed on 12½, 15, 20, 25 ton units
- Supplemental heaters (electric, water, steam) fits directly on unit discharge for low installation cost
- Single point power entry for reduced electrical power installation cost
- Unit fully assembled to reduce field installation costs
- Compact design with low service clearance to reduce building requirements
- Brazed refrigerant piping connections
- Fan relay UL listed and CSA Certified
- Factory installed 2 speed variable frequency drive (VFD) option available for enhanced part load performance and REQUIRED for CA Title 24 Compliance®
- Factory installed Single Zone VAV (SZVAV) option available for enhanced part load performance and space temperature control via varying airflow®
- Optional extended warranties

Model Number Description — Cooling Condenser

Digit 1-3 — Unit Function

TWE = Air Handler

Digit 4-6 — Tonnage

060 = 5 Tons (60Hz) 150 = 12.5 Tons (60Hz)
 072 = 6 Tons (60Hz) 180 = 15 Tons (60Hz)
 090 = 7.5 Tons (60Hz) 240 = 20 Tons (60Hz)
 120 = 10 Tons (60Hz) 300 = 25 Tons (60Hz)

Digit 7 — Refrigerant

4 = R-410A

Digit 8 — Voltage

3 = 208-230VAC - 3 PH (60Hz)
 4 = 460VAC - 3 PH (60Hz)
 W = 575VAC - 3 PH (60Hz)

Digit 9 — Refrigeration Circuit/Stage

A = Single Circuit
 B = Dual Circuit

Digit 10 — Major Design Sequence

A = Current Design Sequence

Digit 11 — Minor Design Sequence

A = Current Design Sequence

Digit 12-13 — Service Digits

00 = 00

Digit 14 — Efficiency Generation

B = Generation B

Digit 15 — Controls

1 = Constant Volume
 C = 2 Stage Airflow (Electromechanical™ Condenser Only)
 D = 2 Stage Airflow/Single Zone VAV (Symbio™ Condenser Only)

Digit 16 — Indoor Fan Sizes

0 = Standard Motor
 4 = High Static - (Oversized Motor for VFD Units)

Digit 17-40 — None

0 = None

Table LAH-2-A — Dual Circuit Coil — R-410A

Tons	Unit Model No.	Power Supply Volts/Phase/Hz	FCCV	"Drive Type"	"Dimensions (in) H x W x D"ⓐ	"Shipping Weight (lbs)"	MCA*	Max Fuse Size or Max Circuit Breakerⓑ
Single Phase								
5	TWE06041B	208-230/1/60	TXV	Belt	48 x 39 x 23	285	8	15
7 ½	TWE09041Bⓐ	208-230/1/60	TXV	Belt	54 x 49 x 26	385	8	15
10	TWE12041Bⓐ	208-230/1/60	TXV	Belt	54 x 65 x 26	441	11	15
Three Phase								
5	TWE06043B	208-230/3/60	TXV	Belt	48 x 39 x 23	285	3	15
5	TWE06044B	460/3/60	TXV	Belt	48 x 39 x 23	285	2	15
6	TWE07243B	208-230/3/60	TXV	Belt	54 x 49 x 26	385	7	15
6	TWE0724WB	575/3/60	TXV	Belt	54 x 49 x 26	385	2	15
7 ½	TWE09043Bⓐ	208-230/3/60	TXV	Belt	54 x 49 x 26	385	7	15
10	TWE12043	208-230/3/60	TXV	Belt	54 x 65 x 26	441	9	15
10	TWE1204W	575/3/60	TXV	Belt	54 x 65 x 26	441	3	15
10	TWE12043B	208-230/3/60	TXV	Belt	54 x 65 x 26	441	9	15
10	TWE1204WB	575/3/60	TXV	Belt	54 x 65 x 26	441	3	15
12 ½	TWE15043Bⓐ	208-230/3/60	TXV	Belt	69 x 81 x 30	753	7	15
12 ½	TWE1504WB	575/3/60	TXV	Belt	69 x 81 x 30	753	3	15
15	TWE18043B	208-230/3/60	TXV	Belt	69 x 81 x 30	752	12	20
15	TWE1804WB	575/3/60	TXV	Belt	69 x 81 x 30	752	4	15
20	TWE24043B	208-230/3/60	TXV	Belt	72 x 94 x 32	912	18	30
20	TWE24044B	460/3/60	TXV	Belt	72 x 94 x 32	912	8	15
20	TWE2404WB	575/3/60	TXV	Belt	72 x 94 x 32	912	7	15
25	TWE30043B	208-230/3/60	TXV	Belt	72 x 94 x 32	993	25	40
25	TWE30044B	460/3/60	TXV	Belt	72 x 94 x 32	993	11	20
25	TWE3004WB	575/3/60	TXV	Belt	72 x 94 x 32	993	9	15

ⓐ Control transformer not included. Order control transformer accessory when matching these air handlers with 3-5 ton condensing units.

ⓑ Ships wired for 208-230/3/60. Field convertible to 460/3/60.

ⓒ HACR type circuit breaker per NEC.

ⓓ Dimensions based on Upflow position.

ⓔ All air handlers are shipped with the drain pan installed in the horizontal position.

For vertical configuration, the drain pan should be repositioned before setting the air handler.

ⓕ 460V motors (digit 8=4) are only available on TWE150E and TWE180 when Title 24 or SZVAV is selected in digits 9 and 10.

* Information subject to change. Please confirm with current Product Data/Service Facts for current factory production.

For complete equipment / combination selections, installation instructions and warranty information, please refer to Product Data/Ratings and/or Installers Guides and Limited Warranty Handbooks.



It's Hard To Stop A Trane.®

Odyssey with Symbio™ Air Handlers, R-410A Electric Heaters

Single Phase - 5, 7.5, and 10 Tons, R-410A
Three Phase – 5-25 Tons

Table LAH-3-A – TWE 5 - 10 Ton Electric Heater Selection

Model Number	Description	Used With
BAYHTRN106*	4.33/5.76 kW Heater 208/240/1 Phase	TWE 060, 090, 120
BAYHTRR112*	8.65/11.52 kW Heater 208/240/1 Phase	TWE 060, 090, 120
BAYHTRS117*	12.98/17.28 kW Heater 208/240/1 Phase	TWE 060, 090, 120
BAYHTRR123*	17.30/23.04 kW Heater 208/240/1 Phase	TWE 060, 090, 120
BAYHTRN129*	21.65/28.8 kW Heater 208/240/1 Phase	TWE 090, 120
BAYHTRN305*	3.75/5.00 kW Heater 208/240/3 Phase	TWE 060, 072, 090, 120
BAYHTRR310*	7.45/9.96 kW Heater 208/240/3 Phase	TWE 060, 072, 090, 120
BAYHTRR315*	11.25/14.96 kW Heater 208/240/3 Phase	TWE 060, 072, 090, 120
BAYHTRN325*	18.71/24.92 kW Heater 208/240/3 Phase	TWE 060, 072, 090, 120
BAYHTRN335*	26.20/34.88 kW Heater 208/240/3 Phase	TWE 090, 120
BAYHTRN405*	5.00 kW Heater 460/3 Phase	TWE 060, 072, 090, 120 ^⓪
BAYHTRR410*	9.96 kW Heater 460/3 Phase	TWE 060, 072, 090, 120 ^⓪
BAYHTRR415*	14.96 kW Heater 460/3 Phase	TWE 060, 072, 090, 120 ^⓪
BAYHTRN425*	24.92 kW Heater 460/3 Phase	TWE 060, 072, 090, 120 ^⓪
BAYHTRN435*	34.88 kW Heater 460/3 Phase	TWE 090, 120 ^⓪
BAYHTRNW05*	5.00 kW Heater 575/3 Phase	TWE 060, 072, 090, 120
BAYHTRRW10*	9.96 kW Heater 575/3 Phase	TWE 060, 072, 090, 120
BAYHTRRW15*	14.96 kW Heater 575/3 Phase	TWE 060, 072, 090, 120
BAYHTRNW25*	24.92 kW Heater 575/3 Phase	TWE 060, 072, 090, 120
BAYHTRNW35*	34.88 kW Heater 575/3 Phase	TWE 090, 120

Table LAH-3-B – TWE 12½ - 20 Ton Electric Heater Selection

Model Number	Description	Used With
BAYHTRP310*	7.75/10.0 kW Heater 208/240/3 Phase	TWE 150, 180, 240, 300
BAYHTRP320*	14.96/19.92 kW Heater 208/240/3 Phase	TWE 150, 180, 240, 300
BAYHTRP330*	22.50/29.92 kW Heater 208/240/3 Phase	TWE 150, 180, 240, 300
BAYHTRP350*	37.42/49.84 kW Heater 208/240/3 Phase	TWE 150, 180, 240, 300
BAYHTRP410*	10.0 kW Heater 460/3 Phase	TWE 150 ^⓪ , 180, 240, 300
BAYHTRP420*	19.92 kW Heater 460/3 Phase	TWE 150 ^⓪ , 180, 240, 300
BAYHTRP430*	29.92 kW Heater 460/3 Phase	TWE 150 ^⓪ , 180, 240, 300
BAYHTRP450*	49.84 kW Heater 460/3 Phase	TWE 150, 180, 240, 300
BAYHTRPW10*	10.0 kW Heater 575/3 Phase	TWE 150, 180, 240, 300
BAYHTRPW20*	19.92 kW Heater 575/3 Phase	TWE 150, 180, 240, 300
BAYHTRPW30*	29.92 kW Heater 575/3 Phase	TWE 150, 180, 240, 300
BAYHTRPW50*	49.84 kW Heater 575/3 Phase	TWE 150, 180, 240, 300

^⓪ Field convertible to 460/3/60.

Light Commercial
Air Handlers/Heaters



It's Hard To Stop A Trane.®

Odyssey with Symbio™ Air Handlers, R-410A Electric Heaters

Single Phase - 5, 7.5, and 10 Tons, R-410A

Three Phase – 5-25 Tons

Table LAH-4-A – 5 – 20 Ton Accessory Selection

Model Number	Description	Used With
Subbase		
BAYBASE009*	Vertical Air Handler Subbase	TWE060
BAYBASE010*	Vertical Air Handler Subbase	TWE072, 090
BAYBASE011*	Vertical Air Handler Subbase	TWE120
BAYBASE012*	Vertical Air Handler Subbase	TWE150, 180
BAYBASE013*	Vertical Air Handler Subbase	TWE240, 300
Grille		
BAYGRLE001*	Return Air Grille	TWE060
BAYGRLE002*	Return Air Grille	TWE072, 090
BAYGRLE003*	Return Air Grille	TWE120
BAYGRLE004*	Return Air Grille	TWE150, 180
BAYGRLE005*	Return Air Grille	TWE240, 300
Isolators		
BAYISLT004* ①②③④	34 Rubber Isolator Floor (blue)	TWE060-120
BAYISLT009* ①②③	3 Rubber Isolator Floor (red)	TWE150, 180
BAYISLT010* ①②③	3 Rubber Isolator Floor (green)	TWE240, 300
BAYISLT012* ③	Rubber Isolator Suspended (red/green)	TWE150, 180
BAYISLT013* ③④	Rubber Suspended (red/green)	TWE060
BAYISLT014* ③④	Rubber Suspended (green)	TWE090
BAYISLT015* ③④	Rubber Suspended (green/black)	TWE120
BAYISLT016* ③	Rubber Suspended (red/green)	TWE240, 300
BAYISLT019* ①②③	Steel Spring Isolator Floor (red)	TWE060-120
BAYISLT021* ①②③	Steel Spring Isolator Floor (black)	TWE150, 180
BAYISLT032* ①②③	Steel Spring Isolator Floor (black/yellow)	TWE240
BAYISLT028* ③	Steel Spring Isolator Suspended (tan)	TWE060
BAYISLT029* ③	Steel Spring Isolator Suspended (red)	TWE072, 090, 120
BAYISLT030* ③	Steel Spring Isolator Suspended (black)	TWE150, 180
BAYISLT031* ③	Steel Spring Isolator Suspended (black/yellow)	TWE240, 300

① When the Air handler is in the vertical position and close proximity trapping of condensate is required, use of subbase is required.

② Requires use of subbase accessory.

③ Units having steam of hot water coils applied vertically or horizontally check IOM for proper Isolator kit selection.

④ Do not use if blower will operate less than 600 RPM.

Light Commercial
Air Handlers/Heaters



It's Hard To Stop A Trane.®

Odyssey with Symbio™ Air Handlers, R-410A Electric Heaters

Single Phase - 5, 7.5, and 10 Tons, R-410A
Three Phase – 5-25 Tons

Table LAH-5-A – TWE 5 - 20 Ton Accessory Selection

Model Number	Description	Used With
Plenum		
BAYPLNM015* ②	Discharge Plenum & Grille	TWE060
BAYPLNM016* ②	Discharge Plenum & Grille	TWE072, 090
BAYPLNM017* ②	Discharge Plenum & Grille	TWE120
BAYPLNM018* ②	Discharge Plenum/Hydronic Coil Plenum & Grille	TWE150, 180
BAYPLNM019* ②	Discharge Plenum/Hydronic Coil Plenum & Grille	TWE240, 300
BAYPLNM020* ②	Hydronic Coil Discharge Plenum & Grille	TWE060
BAYPLNM021* ②	Hydronic Coil Discharge Plenum & Grille	TWE072 090
BAYPLNM022* ②	Hydronic Coil Discharge Plenum & Grille	TWE120
BAYPLNM030* ②	Hydronic Coil Discharge Plenum & Grille	TWE060
BAYPLNM031* ②	Hydronic Coil Discharge Plenum & Grille	TWE072, 090
BAYPLNM032* ②	Hydronic Coil Discharge Plenum & Grille	TWE120
BAYPLNM033* ②	Hydronic Coil Discharge Plenum & Grille	TWE150, 180
BAYPLNM034* ②	Hydronic Coil Discharge Plenum & Grille	TWE240, 300
Transformer		
BAYTFMR018* ①	100 VA Transformer (208-230V)	All TWE072 - TWE300, 208-230V units
BAYTFMR019* ①	100 VA Transformer (460V)	All TWE072 - TWE120, 460V units
BAYTFMR020* ①	100 VA Transformer (575V)	All TWE072 - TWE120, 575V units
BAYTFMR021* ①	100 VA Transformer (400V)	All TWE072 - TWE120 380V/60 Hz units
Water Kits		
BAYWATR022* ②	Steam Coil Enclosure	TWE060
BAYWATR023* ②	Steam Coil Enclosure	TWE072, 090
BAYWATR024* ②	Steam Coil Enclosure	TWE120
BAYWATR025* ②	Steam Coil Enclosure	TWE150, 180
BAYWATR026* ②	Steam Coil Enclosure	TWE240, 300
BAYWATR027* ②	Hot Water Coil Enclosure	TWE060
BAYWATR028* ②	Hot Water Coil Enclosure	TWE072, 090
BAYWATR029* ②	Hot Water Coil Enclosure	TWE120
BAYWATR030* ②	Hot Water Coil Enclosure	TWE150, 180
BAYWATR031* ②	Hot Water Coil Enclosure	TWE240, 300
Wire Kit		
BAYWRKT002* ③	180 Blower Discharge Reversal Kit	BAYWRKT002* TWE060, TWE072, TWE090, TWE120

- ① Required when 6 -10 Ton Air Handlers are matched with 3-5 Ton condensing units.
- ② When installed horizontally, plenum/water coil must be self supported.
- ③ Cannot be used on TWE150-240, due to motor mount location.

Light Commercial
Air Handlers/Heaters

Odyssey with Symbio™ Air Handlers Split Systems 5-25 Tons, R-410A

Light Commercial
Air Handlers/Heaters

Factory Supplied Accessories

- (A) Air Handler (TWE 5 – 25 Tons)
- (B) Outdoor Condensing Unit (TTA – Cooling 6 – 20 Tons)
(TWA – Heat Pump 6 – 20 Tons)
- (P) Discharge Plenum and Grille (BAYPLNM)
- (EH) Electric Heater and Casing (BAYHTRL)
Fits on Top of Unit (13 H x 30 W x 17 D)
- (SB) Subbase (BAYBASE)
- (I) Isolators (BAYISLT)
- (RG) Return Grille (BAYGRLE)
- (CG) Coil Guards (BAYLOAM)
- (WC) Steam/Hot Water Coil (BAYWATR)

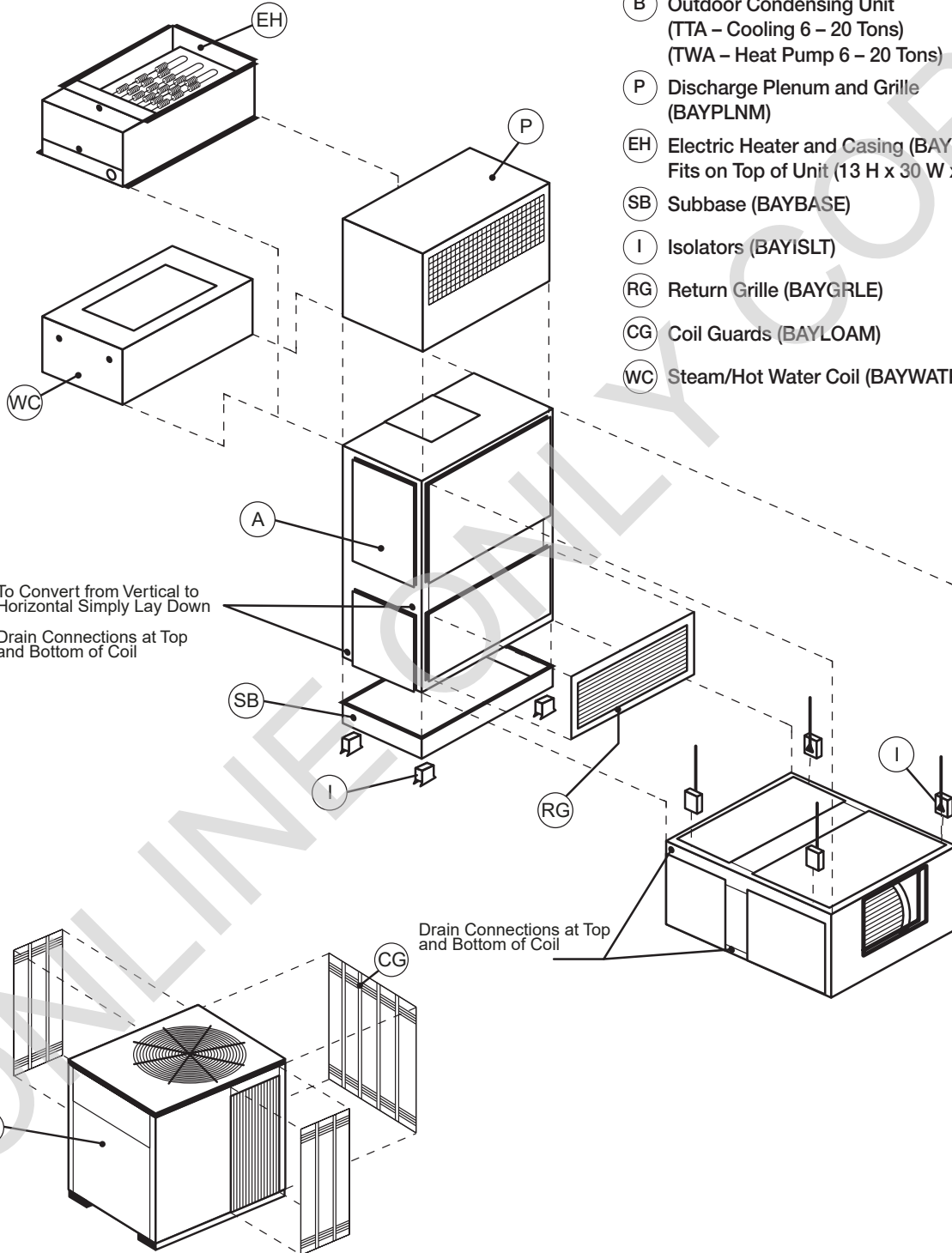



It's Hard To Stop A Trane.®



Beveled Top
Smoother Design
Small compact cabinet
Recessed access handles

Precedent™ Packaged Cooling Convertible 3-5 Tons

Standard Features:

- Trane scroll compressors on all 3-5 ton units
- Colored and numbered wiring
- Phase Monitor, R-410A, 3 Phase Units
- Provisions for through the Base Condensate Drain Connections
- Crankcase Heaters
- 2" throwaway filters provided on all units
- Liquid Line Refrigerant Drier
- Operating Charge of R-410A
- IAQ Sloped Drain Pans
- Single point power for Electric Heat
- Low Ambient to 40°F on Electromechanical models
- Low Ambient to 0°F on ReliaTel™ models
- 5 - year Limited Compressor Warranty
- 1 - year Limited Parts Warranty

Added Flexibility

- Electromechanical or ReliaTel™ controls
(See page LPC-9 for ReliaTel™ Control Information)
- Standard or high efficiency cooling models available. 17+ available in 3-5T. For reference to 17+ please refer to publications RT-PRC048-EN and RT-SLB020-EN.
- Convertible airflow (ships in downflow application)
- Fork lift openings on three sides of unit
- Direct or belt drive - standard or oversized motors (Direct for 3-5 ton only)
- We don't prepackage options
- Choose options tailored to suit each job —pay only for what is needed
- Units ship with options installed —and within our standard ship cycle time

Factory Installed Options

- Through-the-Base — Electrical
- Convenience Outlet — Powered or unpowered
- Unit Disconnect Switch
- Smoke Detectors — Supply, return, or both
- Condenser Coil Coating
- Hinged Access Service Panels
- Discharge Air Sensor
- Fan Fail and Clogged Filter Switches
- Condenser Coil Guard — Hail Protection Quality
- Dehumidification Hot Gas Reheat Coil (High Efficiency Units Only)
- Froststat
- TCI (Trane Communications Interface)
- LonTalk® (Communications Interface)
- BACnet™ (Communications Interface)
- 2" Pleated Media filters
- 2" MERV 8 filters or 2" MERV 13 filters
- Multi-Speed & Single Zone VAV ID Airflow
- Demand Control Ventilation
- Stainless Steel Drainpan
- Condensate Drainpan Overflow Switch

The same Trane Quality and Reliability ... with added Flexibility!

For complete equipment / combination selections, installation instructions and warranty information, please refer to Product Data/Ratings and/or Installers Guides and Limited Warranty Handbooks.

LPC-1

Effective 1/1/23
22-8301-36



It's Hard To Stop A Trane.®

Precedent™ Packaged Cooling Convertible 3-5 Tons, R-410A

Table LPC-2-A — Precedent™ 17 Plus — R-410A — ReliaTel™ Controls Only

Tons	Unit Ordering No.	Performance SEER	Cooling Capacity (Btuh)	Cabinet Dimensions (in.) H x W x L	Downflow Supply	Downflow Return	Shipping Weight (lbs.)	MCA**	Max Fuse**
THC - 208-230/3/60 - Three Phase - No Heat									
3	THC037E3R0A005D	17.5	36,500	36 x 44 x 69	18 x 15.5	24 x 14	614	24	30
4	THC047E3R0A005D	17.5	50,500	41 x 53 x 88	33 x 17.5	32 x 17.5	787	30	40
5	THC067E3R0A005D	17.2	60,000	41 x 53 x 88	33 x 17.5	32 x 17.5	841	33	45
THC - 460/3/60 - Three Phase - No Heat									
3	THC037E4R0A005D	17.5	36,500	36 x 44 x 69	18 x 15.5	24 x 14	614	12	15
4	THC047E4R0A005D	17.5	50,500	41 x 53 x 88	33 x 17.5	32 x 17.5	787	14	20
5	THC067E4R0A005D	17.2	60,000	41 x 53 x 88	33 x 17.5	32 x 17.5	841	16	20

Table PC-2-B — Base Unit — 15 SEER High Efficiency — R-410A — Electromechanical or ReliaTel™

Tons	Unit Ordering No.	Performance [ⓐ] SEER	Cooling Capacity (Btuh)	Cabinet Dimensions (in.) H x W x L	Downflow Supply	Downflow Return	Shipping Weight (lbs.)	MCA**	Max [ⓐ] Fuse**
THC - 208/3/60 - Three Phase - No Heat									
3	THC036E3*0A005D	15.0	37,600	36 x 44 x 69	18 x 15.5	24 x 14	555	21	30
4	THC048E3*0A005D	15.0	49,930	41 x 53 x 88	33 x 17.5	32 x 17.5	637	26	35
5	THC060E3*0A005D	15.0	61,000	41 x 53 x 88	33 x 17.5	32 x 17.5	869	30	45
THC - 460/3/60 - Three Phase - No Heat									
3	THC036E4*0A005D	15.0	37,600	36 x 44 x 69	18 x 15.5	24 x 14	555	12	15
4	THC048E4*0A005D	15.0	49,930	41 x 53 x 88	33 x 17.5	32 x 17.5	637	13	15
5	THC060E4*0A005D	15.0	61,000	41 x 53 x 88	33 x 17.5	32 x 17.5	869	14	20

Table LPC-2-C — Base Unit — 14 SEER — R-410A — Electromechanical or ReliaTel™

Tons	Unit Ordering No.	Performance SEER	Cooling Capacity (Btuh)	Cabinet Dimensions (in.) H x W x L	Downflow Supply	Downflow Return	Shipping Weight (lbs.)	MCA**	Max Fuse**
TSC - 208-230/3/60 - Three Phase - No Heat									
3	TSC036G3*0A005D	14.0	37,000	41 x 44 x 69	18 x 15.5	24 x 14	537	20	30
4	TSC048G3*0A005D	14.0	49,000	41 x 44 x 69	18 x 15.5	24 x 14	557	26	35
5	TSC060G3*0A005D	14.0	60,000	41 x 44 x 69	18 x 15.5	24 x 14	603	29	40
TSC - 460/3/60 - Three Phase - No Heat									
3	TSC036G4*0A005D	14.0	37,000	41 x 44 x 69	18 x 15.5	24 x 14	537	10	15
4	TSC048G4*0A005D	14.0	49,000	41 x 44 x 69	18 x 15.5	24 x 14	557	11	15
5	TSC060G4*0A005D	14.0	60,000	41 x 44 x 69	18 x 15.5	24 x 14	603	13	15
TSC - 575/3/60 - Three Phase - No Heat									
3	TSC036GW*0A005D	14.0	37,000	41 x 44 x 69	18 x 15.5	24 x 14	537	8	15
4	TSC048GW*0A005D	14.0	49,000	41 x 44 x 69	18 x 15.5	24 x 14	557	24	25
5	TSC060GW*0A005D	14.0	60,000	41 x 44 x 69	18 x 15.5	24 x 14	603	10	15

ⓐ HACR breaker per NEC.

ⓐ SEER applies, 3-5 tons; EER applies 6-10 tons.

* Digit 9 - E = Electromechanical or R = ReliaTel™.

** Information subject to change. Please confirm with current Product Data/Service Facts for current factory production.

Light Commercial Packaged Cooling



It's Hard To Stop A Trane.®

Precedent™ Packaged Cooling Convertible 3-5 Tons (Model Digit Numbers)

Digit	Description	Order Number	Digit	Description	Order Number
1-8	Main Assembly (see previous page)		20	Convenience Outlet	
9	Unit Controls			No Convenience Outlet.....	0
	Electro-Mechanical.....	E		Unpowered Convenience Outlet.....	A
	ReliaTel™ Micro-processor.....	R		Powered Convenience Outlet (3 phase only)③.....	B
10	(See Heater Table below)		21	Communications Options④	
11	Design Sequence	*		No Communications Interface.....	0
				Trane Communications Interface (TCI).....	1
				LonTalk® Communications Interface (LCI).....	2
				BACnet™ Communications Interface.....	6
12-13	Service Sequence		22	Refrigeration System Option	
	First Sequence (Factory Supplied).....	*,*		Standard Refrigeration System.....	0
14	Fresh Air Selection			Dehumidification (Hot Gas Reheat Coil)⑤.....	B
	No Fresh Air.....	0	23	Refrigeration Controls	
	0-50% Manual Outside Air Damper⑥.....	A		<i>Note: Applicable to Digit 7 = E, F</i>	
	0-50% Motorized Outside Air Damper.....	B		No Refrigeration Control.....	0
	0-100% Economizer, Dry Bulb without Barometric Relief②.....	C		Frostat④.....	1
	0-100% Economizer, Dry Bulb with Barometric Relief②.....	D	24	Smoke Detector⑤⑥	
	0-100% Economizer, Reference Enthalpy without Barometric Relief①②.....	E		No Smoke Detector.....	0
	0-100% Economizer, Reference Enthalpy with Barometric Relief①②.....	F		Return Air Smoke Detector⑦⑧.....	A
	0-100% Economizer, Comparative Enthalpy without Barometric Relief ①②.....	G		Supply Air Smoke Detector.....	B
	0-100% Economizer, Comparative Enthalpy with Barometric Relief ①②.....	H		Supply and Return Air Smoke Detectors⑦⑧.....	C
	Low Leak Economizer, Dry Bulb with Barometric Relief.....	K		Plenum Smoke Detector.....	D
	Low Leak Economizer, Comparative Enthalpy with Barometric Relief.....	M	25	Monitoring Controls④	
	Low Leak Economizer, Reference Enthalpy with Barometric Relief.....	P		No Monitoring Control④.....	0
15	Supply Fan/Drive Type/Motor			Clogged Filter Switch④.....	1
	Standard Drive.....	0		Fan Failure Switch④.....	2
	Oversized Motor.....	1		Discharge Air Sensing Tube④.....	3
	Optional Belt Drive Motor (3 phase only).....	2		Clogged Filter Switch and Fan Fail Switch④.....	4
	Single Zone VAV.....	6		Clogged Filter Switch and Discharge Air Sensing Tube④.....	5
	Multi-Speed Indoor Fan.....	7		Fan Fail Switch and Discharge Air Sensing Tube④.....	6
	VAV Supply Air Temperature Control Standard Motor.....	E		Clogged Filter and Fan Fail Switches and Discharge Air Sensing Tube④.....	7
16	Hinged Service Access & Filters			Condensate Drain Pan Overflow Switch.....	A
	Standard Panels & Filters.....	0		Clogged Filter Switch④ and Condensate Drain Pan Overflow Switch.....	B
	Hinged Access Panels & Standard Filters.....	A		Fan Failure Switch④ and Condensate Drain Pan Overflow Switch.....	C
	Standard Panels & 2" Pleated Filters MERV 8.....	B		Discharge Air Sensing④ and Condensate Drain Pan Overflow Switch.....	D
	Hinged Access Panels & 2" Pleated Filters MERV 8.....	C		Clogged Filter Switch④, Fan Failure Switch④ and Condensate Drain Pan Overflow Switch.....	E
	Standard Panels/2" MERV 13 Filters.....	D		Clogged Filter Switch④, Discharge Air Sensing Tube④ and Condensate Drain Pan Overflow Switch.....	F
	Hinged Access Panels/2" MERV 13 Filters.....	E		Fan Failure Switch, Discharge Air Sensing Tube④ and Condensate Drain Pan Overflow Switch.....	G
17	Condenser Coil Protection			Clogged Filter Switch④, Fan Failure Switch④, Discharge Air Sensing④ and Condensate Drain Pan Overflow Switch.....	H
	Standard Coil.....	0	26	System Monitoring Controls	
	Standard Coil with Hail Guard.....	1		No Monitoring Controls.....	0
	Black Epoxy Pre-Coated Condenser Coil.....	2		Demand Control Ventilation (CO ₂)④⑨.....	A
	Black Epoxy Pre-Coated Condenser Coil with Hail Guard.....	3	27	Unit Hardware Enhancements	
	Complete Coat™ Condenser Coil.....	4		No Enhancements.....	0
	Complete Coat™ Condenser Coil with Hail Guard.....	5		Stainless Steel Drain Pan.....	1
18	Through the Base Provisions		31	Advanced Unit Controls	
	No Through the Base Provisions.....	0		Standard Unit Controls.....	0
	Through the Base Electric④.....	A		Human Interface.....	1
19	Disconnect/Circuit Breaker /Phase Monitor (3 phase only)				
	No Disconnect/ Circuit Breaker.....	0			
	Unit Mounted Non-Fused Disconnect④.....	1			
	Unit Mounted Circuit Breaker④.....	2			

Light Commercial
Packaged Cooling

① Enthalpy control not available factory installed with electro-mechanical controls.
 ② Economizer with Barometric Relief is for downflow configured units only. Order Economizer without Barometric Relief for horizontal configuration. Barometric relief for horizontal configured units must be ordered as field installed accessory BAYBARM010A.
 ③ Requires use of Disconnect or Circuit Breaker.
 ④ Frostat cannot be field installed in electro-mechanical units.
 ⑤ Not available with BAYFRST001A High Temperature Stat accessory.
 ⑥ The return air smoke detector may not fit up or work properly on the Convertible units when used in conjunction with 3rd party accessories such as bolt on heat wheels, economizers and power exhaust. Do not order the return air smoke detectors when using this type of accessory.
 ⑦ Return Air Smoke Detector cannot be ordered with Novar Controls.
 ⑧ These options are standard when ordering Novar Controls.
 ⑨ This options for use when ordering Novar Control only.
 ⑩ The manual outside air damper will ship factory supplied within the unit, but must be field installed.
 ⑪ Through the base electric required when ordering disconnect/circuit breaker options.
 ⑫ Not available with electro-mechanical unit controls.
 ⑬ Novar Sensor utilized with digit 21 = (4) Novar 3051 Controls without Zone Sensor.
 ⑭ Available for T/Y 10 ton standard efficiency models only.
 ⑮ Available for T/Y 3, 4, 5, 6, 7½, 8½ ton standard/high efficiency models only.
 ⑯ Requires selection of 2" Pleated Filters (option B or C) for Digit 16.
 ⑰ Not available on 6 ton units and all single phase or standard efficiency.
 ⑱ Standard on T/YSC 6, 7½ (single and dual systems), 8½, 10 ton standard efficiency models and T/YHC 4, 5, 6, 7½ ton high efficiency models (except for dehumidification models).
 ⑲ Epoxy coil and epoxy with hailguard options are not available for units with microchannel condenser coil.
 ⑳ Single Zone VAV is only available on 7.5-10 ton high efficiency and 10 ton standard efficiency products with ReliaTel™ controls.
 ㉑ Multi-speed indoor fan available only on 7.5 & 8.5 ton high efficiency, and 10 ton products with ReliaTel™ controls.
 ㉒ Motorized Outside Air Damper is not available on Multi-Speed or SZVAV (Single Zone Variable Air Volume) products.
 ㉓ Frostat standard on Multi-Speed and SZVAV (Single Zone Variable Air Volume) products.
 ㉔ Novar is not available with SZVAV products.
 ㉕ Demand Control Ventilation not available with electromechanical controls.
 ㉖ Demand Control Ventilation Option includes wiring only. The CO₂ sensor is a field-installed only option.
 ㉗ When ordering Dehumidification option, Digit #7 will revert back to E, not F.



It's Hard To Stop A Trane.®

Precedent™ Packaged Cooling Convertible 3-5 Tons (Model Digit Numbers)

Heaters (Digit 10)

kW Rating	Digit	Nominal BTUH	No. Stages	Used With
208/240/3/60				
4.5/6.0	(B)	13,400/20,500	1	T*C036-060*3
9.0/12.0	(E)	30,800/59,400	2	T*C036-060*3
13.1/17.4	(G)	44,600/59,400	2	T*C036-060*3
17.2/23.0	(J)	58,900/78,500	2	T*C060*3
460/3/60				
6.0	(B)	20,500	1	T*C036-060*4
12.0	(E)	41,000	2	T*C036-060*4
17.4	(G)	59,400	2	T*C036-060*4
23.0	(J)	78,500	2	T*C060*4
575/3/60				
6.0	(B)	20,500	1	TSC036-060*W
12.0	(E)	41,000	2	TSC036-060*W
17.4	(G)	59,400	2	TSC036-060*W
23.0	(J)	78,500	2	T*C060*W

Digit 15 Selection Details

Digit 15 = 0

Standard Efficiency

3 Phase (3 to 5 Ton) = Multispeed Direct Drive Motor

High Efficiency

3 Phase (3 to 5 ton) = High Efficiency Multispeed Direct Drive Motor

3 Phase (3 to 5 ton w/Dehumidification) = Belt Drive Motor

Digit 15 = 2

Standard Efficiency

3 Phase = Not Available

High Efficiency

1 Phase = Not Available

Light Commercial
Packaged Cooling



It's Hard To Stop A Trane.®

Precedent™ Packaged Cooling Convertible 3-5 Tons, R-410A Electric Heaters

Table LPC-5-A – Accessory Electric Heaters – Unit with Heater is single circuit / single point power entry (3-5 Ton units)

Model Number	Power Supply	kW Rating	Nominal BTUH	No. Stages	Used With
BAYHTRE306*	208-230/3/60	4.5/6.0	13,400/20,500	1	THC036E3 THC037E3, TSC036G-060G3
BAYHTRE312*	208-230/3/60	9.0/12.0	30,800/41,000	2	THC036E3 THC037E3, TSC036G-060G3
BAYHTRE318*	208-230/3/60	13.0/17.4	44,600/59,400	2	THC036E3 THC037E3, TSC036G-060G3
BAYHTRE323*	208-230/3/60	17.3/23.0	44,600/59,400	2	TSC060G3
BAYHTRE406*	460/3/60	6	20500	1	THC036E4 THC037E4, TSC036G-060G4
BAYHTRE412*	460/3/60	12	41000	2	THC036E4 THC037E4, TSC036G-060G4
BAYHTRE418*	460/3/60	17.4	59400	2	THC036E4 THC037E4, TSC036G-060G4
BAYHTRE423*	460/3/60	17.3/23.0	59400	2	TSC060G4
BAYHTREW06*	575/3/60	6	20500	1	TSC036G-060GW
BAYHTREW12*	575/3/60	12	41000	2	TSC036G-060GW
BAYHTREW18*	575/3/60	17.4	59400	2	TSC036G-060GW
BAYHTREW23*	575/3/60	17.3/23.0	59400	2	TSC060GW
BAYHTRX312*	208-230/3/60	9.0/12.0	30,800/41,000	2	THC047-067E3, THC048-060E3, THC048-048F3
BAYHTRX318*	208-230/3/60	13.0/17.4	44,600/59,400	2	THC047-067E3, THC048-060E3, THC048-048F3
BAYHTRX323*	208-230/3/60	17.3/23.0	59,000/78,500	2	THC067E3, THC060E3, THC060F3
BAYHTRX406*	460/3/60	6	20500	1	THC047-067E4, THC048-060E4, THC048-048F4
BAYHTRX412*	460/3/60	12	41000	2	THC047-067E4, THC048-060E4, THC048-048F4
BAYHTRX418*	460/3/60	18	59400	2	THC047-067E4, THC048-060E4, THC048-048F4
BAYHTRX423*	460/3/60	23	78500	2	THC067E4, THC060E4, THC060F4

(*) - Parts designator subject to change



It's Hard To Stop A Trane.®

Precedent™ Packaged Cooling Convertible 3-5 Tons Accessories

Table LPC-6-A – Accessories

Model Number	Description	Used With
BAYABRD001*	ReliaTel™ Options Module	All Precedents (ReliaTel™) See Note⑥
BAYASCT001	Anti-Short-Cycle Timer	All Precedents (Electro Mechanical)
BAYBARM010*④	Barometric Relief	THC036-060*, THC036E, THC037
BAYBARM011*④	Barometric Relief	THC048*-067*
BAYBCIR200*	BACnet™ Communication Interface	ReliaTel™ Controller (BCI-R)
BAYCO2K001*③⑥	CO ₂ Sensor Kit, Wall Mounted	All CV AND MZVAV
BAYCO2K003*③⑥	CO ₂ Sensor Kit, Duct Mounted	All CV AND MZVAV
BAYCO2K101*	Wall Mounted	All Precedent 2 Speed and SZVAV
BAYCO2K103*	Duct Mounted	All Precedent 2 Speed and SZVAV
BAYCURB042 / FIACURB401*②	Roof Curb	TSC036-060, THC036, THC037
BAYCURB043 / FIACURB402*②	Roof Curb	THC048-067
BAYDMPR053*	0-50% Manual Outside Air Damper	TSC036-060, THC036, THC037
BAYDMPR056*	0-50% Manual Outside Air Damper	THC047-067
BAYDMPR051*	0-50% Motorized Outside Air Damper	TSC036-060, THC036, THC037 (ReliaTel™)
BAYDMPR052*	0-50% Motorized Outside Air Damper	TSC036-060, THC036 (Electro Mechanical)
BAYDMPR054*	0-50% Motorized Outside Air Damper	THC047-120 (ReliaTel™)
BAYDMPR055*	0-50% Motorized Outside Air Damper	THC047-120 (Electro Mechanical)
BAYECON085*③	0-100% Dry Bulb Economizer without Barometric Relief ...	TSC036-060, THC036, THC037 (ReliaTel™)
BAYECON086*③	0-100% Dry Bulb Economizer without Barometric Relief ...	TSC036-060, THC036 (Electro Mechanical)
BAYECON087*③	0-100% Dry Bulb Economizer without Barometric Relief ...	THC047-120 (ReliaTel™)
BAYECON088*③	0-100% Dry Bulb Economizer without Barometric Relief ...	THC048-120 (Electro Mechanical)
BAYECON704*	Downflow Low Leak Economizer	THC047-067 (ReliaTel™)
BAYECON705*	Downflow Low Leak Economizer	TSC036-060, THC036, THC037 (ReliaTel™)
BAYENTH300*	Reference Enthalpy Kit (Solid State)	BAYECON086A, 088A (Electro-Mechanical)
BAYENTH301*	Comparative Enthalpy Kit (Solid State)	BAYECON086A, 088A (Electro-Mechanical)
BAYENTH005*①	Reference Enthalpy Kit	BAYECON085A, 087A (ReliaTel™)
BAYENTH006*①	Comparative Enthalpy Kit	BAYECON086A, 087A (ReliaTel™)
BAYFRST003*③⑥	High Temperature Stat	All Precedents

- ① Kits contain all necessary parts to achieve desired level of enthalpy control.
- ② Lynn Haven Manufacturing has a No-Return policy for this roof curb.
- ③ For use with ReliaTel™ controlled units only.
- ④ Barometric Relief accessory installs in ductwork for horizontal configuration. For downflow configuration, installs in the unit's horizontal return duct. See Installer's Guide for complete instructions.
- ⑤ BAYABRD001C is required when ordering field installed accessories Clogged Filter Switch (BAYDFPS003*), Fan Fail Switch (BAYDFPS004*), Discharge Air Sensing Kit (BAYTUBE004*) or Evaporator Defrost Control (Frostat) (BAYLOAM020*) Ventilation Override Kit (BAYVNOR001*) unless the following options are factory installed: Frostat, Smoke Detector, Clogged Filter Switch, Fan Failure Switch, Discharge Air Sensing Kit. These factory installed options include the ReliaTel™ Options Module.
- ⑥ For use with electromechanical controlled units only.
- ⑦ Activated on Power On.
- ⑧ Field installed accessory requires economizer.
- ⑨ The manual outside air damper will ship factory supplied within the unit, but must be field installed.
- (*) Parts designator subject to change

Light Commercial Packaged Cooling



It's Hard To Stop A Trane.®

Precedent™ Packaged Cooling Convertible 3-5 Tons Accessories

Table LPC-7-A — Accessories

Model Number	Description	Used With
BAYGARD037C	Condenser Coil Hail Guard	THC036, THC037
BAYGARD040C	Condenser Coil Hail Guard	TSC072-090, THC047-067
BAYGARD137A	Condenser Coil Hail Guard	TSC036-060
BAYICSI003A ^③	Trane Communications Interface (TCI)	All Precedents (ReliaTel™)
BAYLMSW001A ^⑩	Power Exhaust Limit Switch	All Precedents
BAYLOAM020B ^{①③④}	Evaporator Defrost Control (Frostat)	THC036 (ReliaTel™)
BAYLOAM120A	Evaporator Defrost Control (Frostat)	TSC036-060 (ReliaTel™)
BAYLSDR006B	Low Static Drive Kit: 3-5T High Efficiency	THC036-060
BAYPWRX026A	Power Exhaust (208-230/3 VAC)	THC047-067*3
BAYPWRX027A	Power Exhaust (460/3 VAC)	THC047-067*4
BAYPWRX028A	Power Exhaust (575/3 VAC)	THC047-067*W
BAYPWRX070A	Power Exhaust (208-230/3 VAC)	TSC036-060*3, THC036*3, THC037*3
BAYPWRX071A	Power Exhaust (460/3 VAC)	TSC036-060*4, THC036*4, THC037*4
BAYPWRX072A	Power Exhaust (575/3 VAC)	TSC036-060*W
BAYQACB009A ^{②⑤}	Quick Adapt Roof Curb	THC047-067
BAYQACB010A ^{②⑤}	Quick Adapt Roof Curb	THC047-067
BAYQACB011A ^{②⑦}	Quick Adapt Roof Curb	THC047-067
BAYQACB012A ^{②⑦}	Quick Adapt Roof Curb	TSC072-120, THC047-102
BAYQACB013 / FIAQACB027 ^{②⑦}	Quick Adapt Roof Curb	TSC072-120, THC047-102
BAYQACB114 / FIAQACB044 ^{②⑩}	Quick Adapt Roof Curb	THC048-067H
BAYQACB115A ^{②⑩}	Quick Adapt Roof Curb	THC048-067H
BAYRTEM001A ^⑩	Fully Featured ReliaTel™ Economizer Logic Model	All Precedents
BAYSTAT023 ^③	Remote Potentiometer	All Precedents
BAYSERV001A ^③	Selective Resistance Service Tester	All Precedents
BAYSENS016A ^③	Temperature Sensor	All Precedents
BAYSENS250A ^{③⑩}	CO2 Duct Mounted, Sensor Only	All Precedents (ReliaTel™)
BAYSENS251A ^{③⑩}	CO2 Wall Mounted, Sensor Only	All Precedents (ReliaTel™)
BAYTUBE005A	Discharge Air Sensing Kit	THC036-037**R
BAYTUBE007A	Discharge Air Sensing Kit	TSC072-102**R, THC047-072**R
BAYTUBE105A	Discharge Air Sensing Kit	TSC036-060**R
BAYVNOR001B ^{③④⑨}	Ventilation Override Kit w/ReliaTel™ options module	All Precedents

- ① For ReliaTel™ microprocessor controlled units only. Must be factory installed for electromechanical controlled units.
- ② Lynn Haven Manufacturing has a No-Return policy for this roof curb.
- ③ For use with ReliaTel™ controlled units only.
- ④ BAYABRD001* is required when ordering field installed accessories Clogged Filter Switch (BAYDFPS003*), Fan Fail Switch (BAYDFPS004*), Discharge Air Sensing Kit (BAYTUBE004*) or Evaporator Defrost Control (Frostat) (BAYLOAM020*) Ventilation Override Kit (BAYVNOR001*) unless the following options are factory installed: Frostat, Smoke Detector, Clogged Filter Switch, Fan Failure Switch, Discharge Air Sensing Kit. These factory installed options include the ReliaTel™ Options Module.
- ⑤ BAYQACB009* adapts Voyager BAYCURB021* to accept Precedent™ 3-5 ton unit. BAYQACB010* adapts Voyager BAYCURB022* to accept Precedent™ unit.
- ⑥ Cannot be used in conjunction with Barometric Relief. Order Economizer without Barometric Relief.
- ⑦ BAYQACB012* adapts Voyager BAYCURB025* to accept Precedent™ 6-10 ton unit. BAYQACB013* adapts Voyager BAYCURB026* to accept Precedent™ 6-10 ton unit.
- ⑧ Interface allows a unit with ReliaTel™ Controls to communicate with Tracer 100, Tracker, VariTrac II, and is the preferred method of communication to Tracer Summit.
- ⑨ Field installed accessory requires economizer.
- ⑩ When ordering a field installed power exhaust on a unit with electromechanical controls, BAYLMSW001* must be ordered.
- ⑪ If any version of comparative or reference enthalpy is ordered, BAYRTEM001A does not need to be ordered.
- ⑫ Order only when unit has factory installed Demand Control Ventilation option.
- ⑬ Precedent E cabinet to Precedent D cabinet (BAYCURB044 to BAYCURB043)
- ⑭ Precedent B cabinet to Precedent C cabinet (BAYCURB042 to BAYCURB043)

Light Commercial
Packaged Cooling



Precedent™ Packaged Cooling Convertible 3-5 Tons, R-410A Zone Sensors / Thermostats

Table LPC-8-A – Zone Sensors for ReliaTel™ Controlled Units

Model Number	Description	Used With
BAYSENS036A2	Wall-Mounted Humidity Zone Sensor	T*C036-067_R (with Reheat)
BAYSENS037A2	Duct-Mounted Humidity Zone Sensor	T*C036-067_E (with Reheat)
BAYSENS073A1	Room Sensor w/ Override and Cancel Buttons	T*036-067*R
BAYSENS074A1	Room Sensor w/ Temp. Adjustment with Override and Cancel Buttons	T*036-067*R
BAYSENS077A	Remote Room Sensor	BAYSENS106B,108B,110B, & 119A
BAYSENS106A	Single Setpoint Manual Changeover	T*C036-067_R
BAYSENS108A	Dual Setpoint Manual or Auto Changeover	T*C036-067_R
BAYSENS110A	Dual Setpoint Man. or Auto Changeover with System Function Lights	T*C036-067_R
BAYSENS119A	Programmable Night Setback w/System Function Lights	T*C036-067_R
BAYSENS135A	Digital Display Zone Sensor	T*C036-067_R
BAYSENS050A3	Wireless Zone Sensor	T*C036-067_R
BAYSENS924A	Title 24 Zone Sensor [Ⓞ]	T*C036-067_R
BAYMTPL110A	Retrofit Wall Cover from Horizontal to Vertical	T*C036-067_R

- Ⓞ Used with Integrated Comfort™ Systems, any unit type. These sensors do not work with TCM. Consult BASD Marketing for them.
 - Ⓞ For use with ReliaTel™ Controls only.
 - Ⓞ Kit comes with everything required for installing and operation.
 - Ⓞ Must be used with ReliaTel™ Control and BCI Communications Interface
- *Either standard or high efficiency models.

Table LPC-8-B – Thermostats – Electromechanical

Model Number	Description	Used With
BAYSTAT150A	2H/2C Digital Display Programmable Thermostat	T*C036-067*E
BAYSTAT152A	3H/2C Programmable Touchscreen Thermostat	T*C036-067*E
BAYSTAT155A	3H/2C Digital Display Thermostat	T*C036-067*E
BAYSTAT170A	Duct Mounted Return Air Sensor	BAYSTAT152A

Light Commercial
Packaged Cooling



It's Hard To Stop A Trane.®

ReliaTel™ Controls for Precedent™ Packaged Unit Protection/Operation Timings and Features

Alternating Lead/Lag – Dual Compressor Models Only –

During periods of part load operation, each compressor cycles alternately as circuit number one, equalizing compressor wear and run time. Enabled by cutting the wire (BLUE) at (RTRM) junction number J3-8. **Standard**

Anti Short Cycle Timer (ASCT) Function – Provides a three (3) minute minimum “ON” time and a three (3) minute minimum “OFF” time for compressors, enhances compressor reliability by ensuring proper oil return. **Standard**

Built In Evaporator Defrost Control (EDC) Function – Provides low ambient cooling down to 0°F. **Standard**

Built In Fan Delay Relay (FDR) Function – Provides custom indoor fan timing sequences for the different types of equipment, enhancing efficiency and reliability. **Standard**

Built In Night Set Back and Unoccupied Functions① – When using a standard dual setpoint/auto change over Zone Sensor Module (ZSM), this function is enabled by applying a short across terminal J6-11 and J6-12. Sets cooling setpoint up a minimum of 7°F, sets heating setpoint back a minimum of 7°F, forces outside air damper (if present) minimum position to zero, and forces fan operation to automatic. **Accessory (requires time clock accessory or field supplied/installed switch or contacts).**

Built In “TEST” Mode – Aids in quick verification of system and control operation, exercises both hardware and software (no special tools required). **Standard**

Built In Unoccupied Mode① – When using a standard single setpoint/manual change over Zone Sensor Module (ZSM), this function is enabled by applying a short across terminal J6-11 and J6-12. Forces outside air damper (if present) minimum position to zero, forces fan operation to automatic. **Accessory (requires time clock accessory or field supplied/installed switch or contacts).**

Direct Digital Control (DDC)① – Proportional Integral (PI) control. Proportional – sets corrective action proportional to deviation from setpoint. Integral – fine tunes the rate of corrective action proportional to the error (results in superior space temperature control). **Standard**

Economizer Preferred Cooling① – Provides fully integrated operation if required. Will not turn on a compressor with the economizer, if the space is recovering adequately with the economizer alone (0.2°F/minute). Allows the equipment to be utilized in more varied applications. **Standard with economizer accessory.**

Emergency Stop Terminals On Low Voltage Terminal Board (LTB-5 and LTB-6) – Provides a convenient point to disable the equipment completely, and immediately. Still provides communication to BAS. **Standard**

Heat Pump Smart Recovery and Smart Staging① – Inhibits auxiliary heat operation if the space is recovering adequately (0.1°F/minute) with the heat pump alone, providing considerable savings in operating costs. **Standard**

Heat Pump Soft Start – Provides a smooth transition into heating after defrost, minimizing noise and compressor stress associated with switch over. **Standard**

Increased Reliability – Fewer components (moving electro-mechanical parts), less likelihood of equipment down time or failure. **Standard**

Integral Electric Heat Staging① – Stages electric heaters “OFF” and “ON”, eliminating the use of outdated sequencers. **Standard**

Intelligent Fallback① – A built in Default Control provides adaptive operation, which allows the equipment to continue to operate, providing comfort in the event of certain component failures. Also, allows emergency operation without a Zone Sensor Module (ZSM). **Standard**

Low Ambient Start Timer (LAST) Function – Bypasses low pressure control when a compressor starts, eliminating nuisance compressor lock outs. **Standard**

Lower Installation Cost – Using a standard Zone Sensor Module (ZSM), control voltage wiring may be run up to five (5) times further than any electromechanical system, with no increase in wire gauge. Example: Electromechanical System – 30 feet maximum using 22 gauge wire. Micro Control System – 150 feet using 22 gauge wire. **Standard**

On Board Diagnostics① – Assist with equipment troubleshooting, if a problem occurrence should take place. **Standard**

Remote Sensing① – All standard Zone Sensor Modules (ZSMs) have remote sensing capabilities, typically achieved by using an expensive program-mable thermostat and remote sensor with electromechanical equipment. **Accessory (requires use of remote sensor).**

Selectable Economizer Dry Bulb Change Over – Allows the capability of selecting the following dry bulb change over points: 63, 67, 70 or 73°F. **Standard with economizer accessory.**

Space Temperature Averaging① – All standard Zone Sensor Modules (ZSMs) have space temperature averaging capabilities, typically achieved by using an expensive programmable thermostat and minimum of four (4) remote sensors with electromechanical equipment. **Averaging with ReliaTel™ can be achieved with two (2) sensors.**

Supply Air Tempering① – A built in feature, once enabled only through an ICS device, may also be enabled using a digital or programmable Zone Sensor Module. When in the HEAT mode (and not actively heating), if supply air temperature drops 10°F below the heating setpoint, heat is turned on until supply air temperature rises to a point 10°F above the heating setpoint. Provides temperate air during the “OFF” cycle, and eliminates cold air dumping from supply ducts. Extremely effective when introducing any quantity of fresh air. **Standard when using a RTOM, ICS device, digital, or programmable Zone Sensor Module.**

Time Delay Relay (TDR) Function – Provides an incremental staging delay between compressors, minimizes equipment current inrush and consumption by keeping compressors from starting simultaneously. **Standard**

Low Pressure and High Pressure Compressor Lockout – 3 trips will lockout control.

① Denotes features lost from utilizing standard conventional stat.



It's Hard To Stop A Trane.®

Precedent™ Packaged Cooling with Symbio™ Convertible 6-25 Tons



Small compact cabinet
Recessed access handles

Standard Features:

- Symbio 700 controller
- MultiSpeed Indoor
- Manifolded scroll compressors
- 6-17.5 tons = 3 stages of cooling; 20-25 tons = 4 stages of cooling
- Microchannel condenser and evaporator coils
- Colored, keyed, and numbered wiring
- Froststat
- Phase monitor
- Coil/Hailguards
- Crankcase heaters on all compressors
- 2" filters
- Backward curved direct drive plenum supply fan
- Liquid line refrigerant drier
- Operating Charge of R-410A
- Composite dual sloped drain pans
- Single point power for electric heat
- Low Ambient cooling to 40°F
- 5 - year Limited Compressor Warranty
- 3 - year Limited Parts Warranty

Added Flexibility

- Standard or high efficiency cooling models available.
- Convertible airflow (ships in downflow application)
- 2" filters included
- Fork lift openings on three sides of unit
- Choose options tailored to suit each job — pay only for what is needed
- Units ship with options installed — and within our standard ship cycle time

Factory Installed Options

- Outdoor air dampers (manual or motorized)
- Economizers (Base or Low Leak)
- Dry Bulb, Reference Enthalpy, Comparative Enthalpy, or Differential Dry Bulb economizer control options
- Multiple electric heat solutions
- Through-the-Base — Electrical
- Convenience Outlet — Powered or unpowered
- Unit Disconnect Switch
- Smoke Detectors — Supply, return, or both
- Condenser Coil Coating
- Hinged Access Service Panels
- Discharge Air Sensor
- Low Ambient cooling to 0°F
- Clogged Filter Switch
- Dehumidification (Modulating Hot Gas Reheat)
- Symbio 700 BACnet® communication interface license
- Symbio 700 LonTalk® communication interface license
- 2" MERV 8 filters or 2" MERV 13 filters
- Single Zone or Multiple Zone VAV Indoor Airflow
- Demand Control Ventilation
- Stainless Steel Drainpan
- Condensate Drainpan Overflow Switch



It's Hard To Stop A Trane.®

Precedent™ Packaged Cooling with Symbio™ Convertible 6 - 25 Tons, High Efficiency R-410A

Table LPC-11-A — Precedent™ High Efficiency — R-410A — Symbio

Tons	Unit Ordering No.	Performance IEER(2-speed)/EER	Net Cooling Capacity (Btuh)	Cabinet Dimensions (in.) H x W x L	Cabinet	Shipping Weight (lbs.)	MCA**	Max Fuse**
THJ - 208-230/3/60 - Three Phase - No Heat								
6	THJ072A3S000000	16.0/12.3	73,000	50 ⁷ / ₈ x 53 ¹ / ₄ x 88 ¹ / ₈	B	1007	38	50
7.5	THJ090A3S000000	16.8/12.3	91,000	50 ⁷ / ₈ x 53 ¹ / ₄ x 88 ¹ / ₈	B	1011	42	50
8.5	THJ102A3S000000	16.8/12.3	104,000	50 ⁷ / ₈ x 53 ¹ / ₄ x 88 ¹ / ₈	B	1027	48	60
10	THJ120A3S000000	15.5/11.7	122,000	50 ⁷ / ₈ x 53 ¹ / ₄ x 88 ¹ / ₈	B	107	54	70
12.5	THJ150A3S000000	15.3/11.1	155,000	50 ⁷ / ₈ x 63 ¹ / ₈ x 99 ⁵ / ₈	C	1412	64	90
15	THJ180A3S000000	17.6/12.1	185,000	59 x 87 x 123	D	2040	78	100
17.5	THJ210A3S000000	15.8/11.7	214,000	59 x 87 x 123	D	2070	93	110
20	THJ240A3S000000	16.5/11.0	246,000	59 x 87 x 123	D	2140	108	125
25	THJ300A3S000000	15.8/10.7	281,000	59 x 87 x 123	D	2190	119	150
THJ - 460/3/60 - Three Phase - No Heat								
6	THJ072A4S000000	16.0/12.3	73,000	50 ⁷ / ₈ x 53 ¹ / ₄ x 88 ¹ / ₈	B	1007	18	20
7.5	THJ090A4S000000	16.8/12.3	91,000	50 ⁷ / ₈ x 53 ¹ / ₄ x 88 ¹ / ₈	B	1011	21	25
8.5	THJ102A4S000000	16.8/12.3	104,000	50 ⁷ / ₈ x 53 ¹ / ₄ x 88 ¹ / ₈	B	1027	25	30
10	THJ120A4S000000	15.5/11.7	122,000	50 ⁷ / ₈ x 53 ¹ / ₄ x 88 ¹ / ₈	B	107	29	40
12.5	THJ150A4S000000	15.3/11.1	155,000	50 ⁷ / ₈ x 63 ¹ / ₈ x 99 ⁵ / ₈	C	1412	33	45
15	THJ180A4S000000	17.6/12.1	185,000	59 x 87 x 123	D	2040	41	50
17.5	THJ210A4S000000	15.8/11.7	214,000	59 x 87 x 123	D	2070	49	60
20	THJ240A4S000000	16.5/11.0	246,000	59 x 87 x 123	D	2140	54	70
25	THJ300A4S000000	15.8/10.7	281,000	59 x 87 x 123	D	2190	59	80
THJ - 575/3/60 - Three Phase - No Heat								
6	THJ072AWS000000	16.0/12.3	73,000	50 ⁷ / ₈ x 53 ¹ / ₄ x 88 ¹ / ₈	B	1007	15	15
7.5	THJ090AWS000000	16.8/12.3	91,000	50 ⁷ / ₈ x 53 ¹ / ₄ x 88 ¹ / ₈	B	1011	17	20
8.5	THJ102AWS000000	16.8/12.3	104,000	50 ⁷ / ₈ x 53 ¹ / ₄ x 88 ¹ / ₈	B	1027	29	40
10	THJ120AWS000000	15.5/11.7	122,000	50 ⁷ / ₈ x 53 ¹ / ₄ x 88 ¹ / ₈	B	107	22	30
12.5	THJ150AWS000000	15.3/11.1	155,000	50 ⁷ / ₈ x 63 ¹ / ₈ x 99 ⁵ / ₈	C	1412	26	35
15	THJ180AWS000000	17.6/12.1	185,000	59 x 87 x 123	D	2040	32	40
17.5	THJ210AWS000000	15.8/11.7	214,000	59 x 87 x 123	D	2070	37	50
20	THJ240AWS000000	16.5/11.0	246,000	59 x 87 x 123	D	2140	47	60
25	THJ300AWS000000	15.8/10.7	281,000	59 x 87 x 123	D	2190	46	60

** Information subject to change. Please confirm with current product catalog Or IOM for current factory production.

For complete equipment / combination selections, installation instructions and warranty information, please refer to Product Data/Ratings and/or Installers Guides and Limited Warranty Handbooks.



It's Hard To Stop A Trane.®

Precedent™ Packaged Cooling with Symbio™ Convertible 6 - 25 Tons, R-410A

Table LPC-12-A – Base Unit – Standard Efficiency – R-410A – Symbio

Tons	Unit Ordering No.	Performance IEER(2-speed)/EER	Net Cooling Capacity (Btuh)	Cabinet Dimensions (in.) H x W x L	Cabinet	Shipping Weight (lbs.)	MCA**	Max Fuse**
TSJ – 208-230/3/60 – Three Phase – No Heat								
6	TSJ072A3S000000	14.8/11.2	72,000	50 ⁷ / ₈ x 53 ¹ / ₄ x 88 ¹ / ₈	B	1007	38	50
7.5	TSJ090A3S000000	14.8/11.2	90,000	50 ⁷ / ₈ x 53 ¹ / ₄ x 88 ¹ / ₈	B	1011	42	50
8.5	TSJ102A3S000000	14.8/11.2	102,000	50 ⁷ / ₈ x 53 ¹ / ₄ x 88 ¹ / ₈	B	1027	48	60
10	TSJ120A3S000000	14.8/11.2	120,000	50 ⁷ / ₈ x 53 ¹ / ₄ x 88 ¹ / ₈	B	107	54	70
12.5	TSJ150A3S000000	14.2/11.0	150,000	50 ⁷ / ₈ x 63 ¹ / ₈ x 99 ⁵ / ₈	C	1412	64	90
15	TSJ180A3S000000	14.2/11.0	182,000	59 x 87 x 123	D	2040	78	100
17.5	TSJ210A3S000000	14.2/11.0	210,000	59 x 87 x 123	D	2070	93	110
20	TSJ240A3S000000	13.2/10.0	240,000	59 x 87 x 123	D	2140	108	125
25	TSJ300A3S000000	13.2/10.0	271,000	59 x 87 x 123	D	2190	119	150
TSJ – 460/3/60 – Three Phase – No Heat								
6	TSJ072A4S000000	14.8/11.2	72,000	50 ⁷ / ₈ x 53 ¹ / ₄ x 88 ¹ / ₈	B	1007	18	20
7.5	TSJ090A4S000000	14.8/11.2	90,000	50 ⁷ / ₈ x 53 ¹ / ₄ x 88 ¹ / ₈	B	1011	21	25
8.5	TSJ102A4S000000	14.8/11.2	102,000	50 ⁷ / ₈ x 53 ¹ / ₄ x 88 ¹ / ₈	B	1027	25	30
10	TSJ120A4S000000	14.8/11.2	120,000	50 ⁷ / ₈ x 53 ¹ / ₄ x 88 ¹ / ₈	B	107	29	40
12.5	TSJ150A4S000000	14.2/11.0	150,000	50 ⁷ / ₈ x 63 ¹ / ₈ x 99 ⁵ / ₈	C	1412	33	45
15	TSJ180A4S000000	14.2/11.0	182,000	59 x 87 x 123	D	2040	41	50
17.5	TSJ210A4S000000	14.2/11.0	210,000	59 x 87 x 123	D	2070	49	60
20	TSJ240A4S000000	13.2/10.0	240,000	59 x 87 x 123	D	2140	54	70
25	TSJ300A4S000000	13.2/10.0	271,000	59 x 87 x 123	D	2190	59	80
TSJ – 575/3/60 – Three Phase – No Heat								
6	TSJ072AWS000000	14.8/11.2	72,000	50 ⁷ / ₈ x 53 ¹ / ₄ x 88 ¹ / ₈	B	1007	15	15
7.5	TSJ090AWS000000	14.8/11.2	90,000	50 ⁷ / ₈ x 53 ¹ / ₄ x 88 ¹ / ₈	B	1011	17	20
8.5	TSJ102AWS000000	14.8/11.2	102,000	50 ⁷ / ₈ x 53 ¹ / ₄ x 88 ¹ / ₈	B	1027	29	40
10	TSJ120AWS000000	14.8/11.2	120,000	50 ⁷ / ₈ x 53 ¹ / ₄ x 88 ¹ / ₈	B	107	22	30
12.5	TSJ150AWS000000	14.2/11.0	150,000	50 ⁷ / ₈ x 63 ¹ / ₈ x 99 ⁵ / ₈	C	1412	26	35
15	TSJ180AWS000000	14.2/11.0	182,000	59 x 87 x 123	D	2040	32	40
17.5	TSJ210AWS000000	14.2/11.0	210,000	59 x 87 x 123	D	2070	37	50
20	TSJ240AWS000000	13.2/10.0	240,000	59 x 87 x 123	D	2140	47	60
25	TSJ300AWS000000	13.2/10.0	271,000	59 x 87 x 123	D	2190	46	60

** Information subject to change. Please confirm with current product catalog Or IOM for current factory production.

Light Commercial
Packaged Cooling



Precedent™ Packaged Cooling with Symbio Convertible 6-25 Tons (Model Digit Numbers)

Digit	Description	Order Number	Digit	Description	Order Number
1	Unit Function		16	Hinged Service Access & Filters	
	DX Cooling.....	T		Standard Panels/Standard Filters.....	0
2	Cooling Efficiency			Hinged Access Panels/Standard Filters.....	A
	Standard Efficiency.....	S		Standard Panels/2" MERV 8 Filters.....	B
	High Efficiency.....	H		Hinged Access Panels/2" MERV 8 Filters.....	C
3	Refrigerant			Standard Panels/2" MERV 13 Filters.....	D
	R-410A.....	J		Hinged Access Panels/2" MERV 13 Filters.....	E
4,5,6	Nominal Gross Cooling Capacity (MBh)		17	Condenser Coil Protection	
	6 Ton.....	072		Standard Coil.....	0
	7.5 Ton.....	090		Condenser with CompleteCoat™.....	1
	8.5 Ton.....	102	18	Through the Base Provisions	
	10 Ton.....	120		No Through-the-Base-Provisions.....	0
	12.5 Ton.....	150		Through-the-Base Electric.....	A
	15 Ton.....	180	19	Disconnect/Circuit Breaker (3 phase only)	
	17.5 Ton.....	210		No Disconnect/Circuit Breaker.....	0
	20 Ton.....	240		Unit Mounted/Non-Fused Disconnect.....	1
	25 Ton.....	300		Unit Mounted Circuit Breaker.....	2
7	Design Sequence		20	Convenience Outlet	
		*		No Convenience Outlet.....	0
8	Voltage			Unpowered 20A Convenience Outlet.....	A
	208-230/60/3.....	3		Powered 15A Convenience Outlet (3 phase only).....	B
	460/60/3.....	4	21	Communications Options	
	575/60/3.....	W		No Communications Interface.....	0
9	Unit Controls			Advanced Controller with BACnet® Communications Interface.....	1
	Symbio 700.....	S		Advanced Controller with LonTalk® Communications Interface.....	2
10	Heat Type			Advanced Controller with Air-Fi® Communications Interface.....	3
	Base Model (None or Electric).....	0	22	Refrigeration System Option	
11	Heating Capacity			Standard Refrigeration System.....	0
	No Heat.....	0		Dehumidification Option ①②.....	A
	9 kW Electric Heat.....	C	23	Controls Expansion Module	
	18 kW Electric Heat.....	G		None.....	0
	27 kW Electric Heat.....	K		XM-30 Expansion Module.....	1
	36 kW Electric Heat.....	N		XM-32 Expansion Module.....	2
	54 kW Electric Heat.....	P		XM-30 and XM-32 Expansion Module.....	3
	72 kW Electric Heat.....	R		XM-30 Expansion Module (Qty 2).....	4
12-13	Service Sequence			XM-32 Expansion Module (Qty 2).....	5
	Factory Supplied.....	*,*#	24	Smoke Detector	
14	Fresh Air Selection			No Smoke Detector.....	0
	No Fresh Air.....	0		Return Air Smoke Detector2.....	A
	Manual Outside Air Damper 0-50%.....	A		Supply Air Smoke Detector1.....	B
	Motorized Outside Air Damper 0-50%.....	B		Supply and Return Air Smoke Detectors ①②.....	C
	Economizer, Dry Bulb 0-100% without Barometric Relief②.....	C	25	System Monitoring Controls	
	Economizer, Dry Bulb 0-100% with Barometric Relief②.....	D		No Monitoring Control.....	0
	Economizer, Reference Enthalpy 0-100% without Barometric Relief②.....	E		Clogged Filter Switch2.....	1
	Economizer, Reference Enthalpy 0-100% with Barometric Relief②.....	F		Condensate Overflow Switch①.....	2
	Economizer, Comparative Enthalpy 0-100% without Barometric Relief②.....	G		Discharge Air Sensing Tube.....	3
	Economizer, Comparative Enthalpy 0-100% with Barometric Relief②.....	H		Clogged Filter Switch and Condensate Overflow Switch②.....	4
	Downflow Low Leak Economizer, Dry Bulb with Barometric Relief②.....	K		Clogged Filter Switch and Discharge Air Sensing Tube②.....	5
	Downflow Low Leak Economizer, Reference Enthalpy with Barometric Relief②.....	M		Condensate Overflow Switch and Discharge Air Sensing Tube①.....	6
	Downflow Low Leak Economizer, Comparative Enthalpy with Barometric Relief②.....	P		Clogged Filter Switch, Condensate Overflow Switch and Discharge Air Sensing Tube①②.....	7
	Downflow Low Leak Economizer, Differential Dry Bulb with Barometric Relief②.....	R	26	Not Used	
15	Supply Fan/Drive Type/Motor				
	Standard Drive.....	0	27	Hardware Enhancements	
	Optional Oversized/High Static Motor.....	1		No Enhancements.....	0
	Single Zone Variable Air Volume (SZVAV) with Standard Motor.....	2		Stainless Steel Drain Pan.....	1
	Single Zone Variable Air Volume (SZVAV) with Oversized/High Static Motor.....	3	28	Short Circuit Current Rating	
	Multiple Zone Variable Air Volume (MZVAV) with Standard Motor.....	4		Standard (5k) SCCR Marking.....	0
	Multiple Zone Variable Air Volume (MZVAV) with Oversized/High Static Motor.....	5		Tier 2 (=65K) SCCR Marking.....	A
			29	Low Ambient4	
				None.....	0
				Low Ambient Cooling to 0°F.....	A

① Includes Symbio Indoor Module.
 ② Includes Symbio Fresh Air Module.
 ③ Includes Symbio Customer Connection Module.
 ④ Standard Low Ambient Cooling Limit is 40°F.

Light Commercial Packaged Cooling



It's Hard To Stop A Trane.®

Precedent™ Packaged Cooling with Symbio Convertible 6-25 Tons, R-410A Electric Heaters

Table LPC-14-A – Accessory – Electric Heaters

Model Number	Power Supply	kW Rating	Nominal BTUH	No. Stages	Used With Cabinet	Used With
FIAEHTB309*①	208-230/3/60	6.8/9	23,203/30,709	1	B	TSJ/THJ072A3-102A3
FIAEHTB318*①	208-230/3/60	13.5/18	46,064/61,419	1	B	TSJ/THJ072A3-120A3
FIAEHTB327*①	208-230/3/60	20.3/27	69,266/92,128	2	B	TSJ/THJ072A3-120A3
FIAEHTB336*①	208-230/3/60	27/36	92,128/122,837	2	B	TSJ/THJ072A3-120A3
FIAEHTB354*①	208-230/3/60	40.6/54	138,533/184,256	2	B	TSJ/THJ120A3
FIAEHTC318*①	208-230/3/60	13.5/18	46,064/61,419	1	C	TSJ/THJ150A3
FIAEHTC327*①	208-230/3/60	20.3/27	69,266/92,128	2	C	TSJ/THJ150A3
FIAEHTC336*①	208-230/3/60	27/36	92,128/122,837	2	C	TSJ/THJ150A3
FIAEHTC354*①	208-230/3/60	40.6/54	138,533/184,256	2	C	TSJ/THJ150A3
FIAEHTD318*①	208-230/3/60	13.5/18	46,064/61,419	1	D	TSJ/THJ180A3
FIAEHTD336*①	208-230/3/60	27/36	92,128/122,837	2	D	TSJ/THJ180A3-300A3
FIAEHTD354*①	208-230/3/60	40.6/54	138,533/184,256	2	D	TSJ/THJ180A3-300A3
FIAEHTD372*①	208-230/3/60	54/72	184,256/245,674	2	D	TSJ/THJ210A3-300A3
FIAEHTB409*①	460/3/60	9	30,709	1	B	TSJ/THJ072A4-102A4
FIAEHTB418*①	460/3/60	18	61,419	1	B	TSJ/THJ072A4-120A4
FIAEHTB427*①	460/3/60	27	92,128	2	B	TSJ/THJ072A4-120A4
FIAEHTB436*①	460/3/60	36	122,837	2	B	TSJ/THJ072A4-120A4
FIAEHTB454*①	460/3/60	54	184,256	2	B	TSJ/THJ120A4
FIAEHTC418*①	460/3/60	18	61,419	1	C	TSJ/THJ150A4
FIAEHTC427*①	460/3/60	27	92,128	2	C	TSJ/THJ150A4
FIAEHTC436*①	460/3/60	36	122,837	2	C	TSJ/THJ150A4
FIAEHTC454*①	460/3/60	54	184,256	2	C	TSJ/THJ150A4
FIAEHTD418*①	460/3/60	18	61,419	1	D	TSJ/THJ180A4
FIAEHTD436*①	460/3/60	36	122,837	2	D	TSJ/THJ180A4-300A4
FIAEHTD454*①	460/3/60	54	184,256	2	D	TSJ/THJ180A4-300A4
FIAEHTD472*①	460/3/60	72	245,674	2	D	TSJ/THJ210A4-300A4
FIAEHTBW09*①	575/3/60	9	30,709	1	B	TSJ/THJ072AW-102AW
FIAEHTBW18*①	575/3/60	18	61,419	1	B	TSJ/THJ072AW-120AW
FIAEHTBW27*①	575/3/60	27	92,128	2	B	TSJ/THJ072AW-120AW
FIAEHTBW36*①	575/3/60	36	122,837	2	B	TSJ/THJ072AW-120AW
FIAEHTBW54*①	575/3/60	54	184,256	2	B	TSJ/THJ120AW
FIAEHTCW18*①	575/3/60	18	61,419	1	C	TSJ/THJ150AW
FIAEHTCW27*①	575/3/60	27	92,128	2	C	TSJ/THJ150AW
FIAEHTCW36*①	575/3/60	36	122,837	2	C	TSJ/THJ150AW
FIAEHTCW54*①	575/3/60	54	184,256	2	C	TSJ/THJ150AW
FIAEHTDW18*①	575/3/60	18	61,419	1	D	TSJ/THJ180AW
FIAEHTDW36*①	575/3/60	36	122,837	2	D	TSJ/THJ180AW-300AW
FIAEHTDW54*①	575/3/60	54	184,256	2	D	TSJ/THJ180AW-300AW
FIAEHTDW72*①	575/3/60	72	245,674	2	D	TSJ/THJ210AW-300AW

① Requires Symbio™ Indoor Options Module (FIAOPTN001*) for field installed. Factory installed includes indoor option module.

(*) Parts designator subject to change

Light Commercial
Packaged Cooling



It's Hard To Stop A Trane.®

Precedent™ Packaged Cooling with Symbio Convertible 6-25 Tons, R-410A Accessories

Table LPC-15-A – Accessories

Model Number	Description	Used With Cabinets	Used With
FIABARM002*	Barometric Relief	B/C	TSJ/THJ072A-150A
FIABARM003*	Barometric Relief	D	TSJ/THJ180-300A
FIAC02K001*	CO2 (DCV) Wall Mounted Sensor	ALL	TSJ/THJ072A-300A
FIAC02K002*	CO2 (DCV) Duct Mounted Sensor	ALL	TSJ/THJ072A-300A
FIACURB402*	14-inch Full Perimeter Knockdown Curb	B	TSJ/THJ072A-120A
FIACURB403*	14-inch Full Perimeter Knockdown Curb	C	TSJ/THJ150A
FIACURB404*	14-inch Full Perimeter Knockdown Curb	D	TSJ/THJ180A-300A
FIACLFS001*②	Clogged Filter Switch	B/C	TSJ/THJ072A-150A
FIACLFS002*②	Clogged Filter Switch (MERV13)	B/C	TSJ/THJ072A-150A
FIACLFS003*②	Clogged Filter Switch	D	TSJ/THJ180A-300A
FIACLFS004*②	Clogged Filter Switch (MERV13)	D	TSJ/THJ180A-300A
FIADAST003*	Discharge Air Sensing Tube Kit T/W Models	B	TSJ/THJ072A-120A
FIADAST005*	Discharge Air Sensing Tube Kit T/W Models	C	TSJ/THJ150A
FIADAST008*	Discharge Air Sensing Tube Kit T/W Models	D	TSJ/THJ180A-300A
FIADFDB001*②	Differential Dry Bulb Economizer Control	ALL	TSJ/THJ072A-300A
FIADMPR002*	Manual Damper	B/C	TSJ/THJ072A-150A
FIADMPR003*	Manual Damper	D	TSJ/THJ180A-300A
FIADMPR102*	Motorized Damper	B/C	TSJ/THJ072A-150A
FIADMPR103*	Motorized Damper	D	TSJ/THJ180A-300A
FIAECON002*②	Dry Bulb Economizer	B/C	TSJ/THJ072A-150A
FIAECON102*②	Dry Bulb Downflow Low Leak	B/C	TSJ/THJ072A-150A
FIAECON003*②	Dry Bulb Downflow Economizer	D	TSJ/THJ180A-300A
FIAECON303*②	Dry Bulb Horizontal Economizer	D	TSJ/THJ180A-300A
FIAECON103*②	Dry Bulb Downflow Low Leak	D	TSJ/THJ180A-300A
FIAECON203*②	Dry Bulb Horizontal Low Leak	D	TSJ/THJ180A-300A
FIAENTH001*	Reference Enthalpy Economizer Control	ALL	TSJ/THJ072A-300A
FIAENTH002*	Comparative Enthalpy Economizer Control	ALL	TSJ/THJ072A-300A
FIAHTST001*	High Temperature (Fire) Duct Mounted Stat	ALL	TSJ/THJ072A-300A
FIAHZDC001*	Horizontal Conversion Panel	D	TSJ/THJ180A-300A
FIALOAM001*	Low Ambient	ALL	TSJ/THJ072A-300A
FIALTCI001*	LonTalk Communication Interface	ALL	TSJ/THJ072A-300A
FIAOPTN001*	Indoor Options Module	ALL	TSJ/THJ072A-300A
FIAOPTN002*	Fresh Air Options Module	ALL	TSJ/THJ072A-300A
FIAOVFL001*①	Condensate Overflow Switch	ALL	TSJ/THJ072A-300A
FIAPWRX302*	Power Exhaust 230V	B/C	TSJ/THJ072A3-150A3
FIAPWRX402*	Power Exhaust 460V	B/C	TSJ/THJ072A4-150A4
FIAPWRXW02*	Power Exhaust 575V	B/C	TSJ/THJ072AW-150AW
FIAPWRX303*	Power Exhaust 230V	D	TSJ/THJ180A3-300A3
FIAPWRX403*	Power Exhaust 460V	D	TSJ/THJ180A4-300A4
FIAPWRXW03*	Power Exhaust 575V	D	TSJ/THJ180AW-300AW
FIAQACB026*	Adapter Curb, Existing BAYCURB026 to New C Cabinet (FIACURB403A)	C	TSJ/THJ150A
FIAQACB027*	Adapter Curb, Existing BAYCURB027 to New C Cabinet (BAYCURB403A)	C	TSJ/THJ150A
FIAQACB044*	Adapter Curb, Existing BAYCURB044 to New B Cabinet (BAYCURB402A)	B	TSJ/THJ072A-120A
FIASCCM001*③④	Symbio Customer Connection Module	ALL	TSJ/THJ072A-300A
FIAXMOD030*④⑤	Symbio 700 XM30 Expansion Module	ALL	TSJ/THJ072A-300A
FIAXMOD032*④⑤	Symbio 700 XM32 Expansion Module	ALL	TSJ/THJ072A-300A

- ① Requires Symbio™ Indoor Options Module.
- ② Requires Symbio™ Fresh Air Options Module.
- ③ Provides Ventilation Override, External Auto/Stop, Alarm Indicator, Remote Min Position.
- ④ Requires Symbio™ Advanced Controller (digit 21=1 or 3).
- ⑤ Requires Tracer TU and Utilizes TGP2 Software (programming knowledge required).
- (*) Parts designator subject to change

For complete equipment / combination selections, installation instructions and warranty information, please refer to Product Data/Ratings and/or Installers Guides and Limited Warranty Handbooks.



It's Hard To Stop A Trane.®

Foundation™ Packaged Cooling 3-5 Tons, R-410A



- Scroll compressors on all units
- Operating Charge of R-410A
- Low ambient operation of 40°F as standard
- Color coded and numbered wiring
- Single side service access
- Provisions for through the base connections
- Phase monitor on all units
- Convertible airflow on all units
- Non-corrosive drain pan
- Separate high and low voltage areas in control box
- 5-year limited compressor and heat exchanger warranty

Table LPC-16-A — Foundation™ - R-410A - Electromechanical Controls

Tons	Unit Model No	Power Supply Volts/Phase/Hz	Performance SEER	Cooling Capacity (Btuh)	Dimensions (in.) H x W x L	Shipping Weight (lbs.)	MCA**	Max Fuse Size or Max Circuit Breaker**	Downflow Roofcurb [Ⓢ]
GBC - Three Phase No Heat									
3	EBC036A3E0B0000	208-230/3/60	14.0	36,000	42 ⁵ / ₈ x 48 x 76 ⁷ / ₈	523	19.5	25	BAYCURB320
4	EBC048A3E0B0000	208-230/3/60	14.0	48,000	42 ⁵ / ₈ x 48 x 76 ⁷ / ₈	566	23.6	35	BAYCURB320
5	EBC060A3E0B0000	208-230/3/60	14.0	57,500	42 ⁵ / ₈ x 48 x 76 ⁷ / ₈	586	26.4	40	BAYCURB320
3	EBC036A4E0B0000	460/3/60	14.0	36,000	42 ⁵ / ₈ x 48 x 76 ⁷ / ₈	523	10.5	15	BAYCURB320
4	EBC048A4E0B0000	460/3/60	14.0	48,000	42 ⁵ / ₈ x 48 x 76 ⁷ / ₈	566	11	15	BAYCURB320
5	EBC060A4E0B0000	460/3/60	14.0	57,500	42 ⁵ / ₈ x 48 x 76 ⁷ / ₈	586	12.9	20	BAYCURB320
3	EBC036AWE0B0000	575/3/60	14.0	36,000	42 ⁵ / ₈ x 48 x 76 ⁷ / ₈	523	6.8	15	BAYCURB320
4	EBC048AWE0B0000	575/3/60	14.0	48,000	42 ⁵ / ₈ x 48 x 76 ⁷ / ₈	566	8.1	15	BAYCURB320
5	EBC060AWE0B0000	575/3/60	14.0	57,500	42 ⁵ / ₈ x 48 x 76 ⁷ / ₈	586	9.2	15	BAYCURB320

Ⓢ For Downflow units only.

** Information subject to change. Please confirm with current Product Data/Service Facts for current factory production.

Foundation 3-5 Ton EBC units replace the following Carrier units without need for a curb adapter
50DJ 004-006
50GJ 006
50HC 004-006
50HE 004-006
50HJ 004-006
50KC 004-006
50LC 004-006
50LJ 004-006
50TC 004-006
50TFF 004-006
50TJ 004-006
50TM 004-006

Light Commercial
Packaged Cooling

For complete equipment / combination selections, installation instructions and warranty information, please refer to Product Data/Ratings and/or Installers Guides and Limited Warranty Handbooks.



It's Hard To Stop A Trane.®

Foundation™ Packaged Cooling 3-5 Tons, R-410A (Model Digit Numbers)

Digit	Description	Order Number	Digit	Description	Order Number
1	Unit Function		15	Supply Fan/Drive Type/Motor	
	Packaged Cooling, Electric Heat	E		Multi-Speed Standard Motor.....	7
2	Efficiency			Multi-Speed Oversized Motor	9
	Generation B.....	B	16	Access	
	Generation C - DOE.....	C		Standard Fork Access	0
3	Airflow Configuration			Third Side Condenser Fork Access (15-25 Tons)	F
	Convertible.....	C	17	Condenser Coil Protection	
4,5,6	Nominal Gross Cooling Capacity (MBh)			Standard Coil	0
	3 Ton.....	036		Condenser with CompleteCoat™	4
	4 Ton.....	048	18	Through the Base Provisions	
	5 Ton.....	060		No Through-the-Base-Provisions	0
	15 Ton.....	180		Through-the-Base Electric	A
	17.5 Ton.....	210	19	Disconnect/Circuit Breake (3 phase only)	
	20 Ton.....	240		No Disconnect/Circuit Breaker	0
	25 Ton.....	300		Unit Mounted/Non-Fused Disconnect®	1
7	Design Sequence		20-24	Not Used	
		*		No Convenience Outlet	0000
8	Voltage		25	System Monitoring Controls 1	
	208-230/60/3	3		No Monitoring Controls	0
	460/60/3	4		Condensate Drain Pan Overflow Switch.....	A
	575/60/3	W	26	System Monitoring Controls 2	
9	Unit Controls			Economizer Fault Detection and Diagnostics (FDD)®	B
	Electromechanical	E			
10	Heating Capacity				
	No Heat	0			
	5 kW Electric Heat	A			
	7.5 kW Electric Heat	B			
	10 kW Electric Heat	C			
	14.4 kW Electric Heat	D			
	20 kW Electric Heat	E			
	25 kW Electric Heat	F			
	18 kW Electric Heat	G			
	36 kW Electric Heat	N			
	54 kW Electric Heat	P			
	72 kW Electric Heat	R			
11	Design Sequence				
		*			
12-13	Service Sequence				
		,			
14	Fresh Air Selection				
	No Fresh Air	0			
	Manual Outside Air Damper 0-25%	A			
	Motorized Outside Air Damper 0-50%	B			
	Economizer, Dry Bulb 0-100% without Barometric Relief.....	C			
	Economizer, Dry Bulb 0-100% with Barometric Relief①.....	D			
	Economizer, Reference Enthalpy 0-100% without Barometric Relief.....	E			
	Economizer, Reference Enthalpy 0-100% with Barometric Relief①	F			
	Economizer, Comparative Enthalpy 0-100% without Barometric Relief.....	G			
	Economizer, Comparative Enthalpy 0-100% with Barometric Relief①	H			
	Downflow Low Leak Economizer, Dry Bulb without Barometric Relief.....	J			
	Downflow Low Leak Economizer, Reference Enthalpy without Barometric Relief.....	L			
	Downflow Low Leak Economizer, Comparative Enthalpy without Barometric Relief.....	N			

- ① Some field set up required
- ② Must be ordered through the base electrical option
- ③ All factory installed Options are Built-to-Order. Check order services for estimated production cycle
- ④ Factory installed economizers only available in downflow configuration
- ⑤ Fault Detection and Diagnostics (FDD) is available on Low Leak Economizers only

Light Commercial
Packaged Cooling



It's Hard To Stop A Trane.®

Foundation™ Packaged Cooling 3-5 Ton Accessories

Table LPC-18-A – Foundation™ – Field Installed Accessories

Model Number	Description	Used With
BAYCURB320	Roof curb	All
BAYGARD320	Tool-less Hail Guard	All
BAYTBUE320	Through the base - Elec.	All
BAYDSCF320	Unit Mounted Disconnect- cooling only, 100 Amp	GBC, EBC No Elec Heat
BAYDSCF321	Unit Mounted Disconnect - electric heat, 100 Amp	EBC w/Elec Heat
BAYCO2K300	Wall Mounted CO2 Sensor	All
BAYCO2K301	Duct Mounted CO2 Sensor	All
BAYCOSW320	Condensate Overflow	All
BAYCCHT010	CCH – 208-230V (40 W) 6.5"	E/GBC(048 & 060)A3
BAYCCHT011	CCH - 460V/572V (40W) 6.5"	E/GBC(048 & 060A)(4 & W)
BAYCCHT103	CCH – 208-230V (40 W) 5.5"	E/GBC036A3
BAYCCHT405	CCH - 460V/572V (40W) 5.5"	E/GBC036A(4 & W)
BAYLOAM330	Frostat	All
BAYLOAM340	Low Ambient Kit	All
BAYASCT001	Compressor Short Cycle Timer	All
BAYHSMT320	2 HP Oversize motor Kit (208-230/460V)	All
BAYHSMT321	2 HP Oversize motor Kit (380V)	All
BAYHSMT322	2 HP Oversize motor Kit (575V)	All
BAYDMPR321	Damper, Manual 3-5T	All
BAYDMPR320	Damper, Motorized 3-5T	All
BAYBARO320	Barometric Relief Damper, 3-5T	All
BAYECON320	Economizer, Dry Bulb, Downflow 3-5T	All
BAYENTH320	Reference Enthalpy Economizer, 3-5T	All
BAYENTH321	Comparative Enthalpy Economizer, 3-5T	All
BAYECON353②	Low Leak Economizer, Dry Bulb, Downflow W/FDD, 3-5T	All
BAYECON354②	Low Leak Economizer, Dry Bulb, Horizontal W/FDD, 3-5T	All
BAYENTH323A②	Comparative Enthalpy, LLE W/FDD, 3-5T	All
BAYENTH322A②	Reference Enthalpy, LLE W/FDD, 3-5T	All
BAYBARO321A②	Barometric Relief Damper, LLE W/FDD, 3-5T	All
BAYPWRX320A①	Power Exhaust, 3-5T DF, 230V	All
BAYPWRX321A①	Power Exhaust, 3-5T DF, 460V	All
BAYPWRX322A①	Power Exhasut, 3-5T DF, 575V	All

① Please check availability.
② FDD = Fault Detection & Diagnostics.

Light Commercial
Packaged Cooling



It's Hard To Stop A Trane.®

Foundation™ Packaged Cooling 3-5 Ton Heaters

Table LPC-19-A — Foundation™ - R-410A - Field Installed Accessories

Model No	Power Supply	kW Rating	Nominal BTUH)	No. Stages	Used With
BAYHTFA305	208-230/3/60	3.5 / 4.7	12,800 / 17,100	1	EBC*A3*
BAYHTFA307	208-230/3/60	5.6 / 7.5	19,200 / 25,600	1	EBC*A3*
BAYHTFA310	208-230/3/60	7.5 / 10	25,700 / 34,200	1	EBC*A3*
BAYHTFA315	208-230/3/60	10.8 / 14.4	38,400 / 51,200	1	EBC*A3*
BAYHTFA320	208-230/3/60	15 / 20	51,300 / 68,300	2	EBC048A3*, EBC060A3*
BAYHTFA325	208-230/3/60	18.8 / 25	64,100 / 85,400	2	EBC060A3*
BAYHTFA405	460/3/60	5	17,100	1	EBC*A4*
BAYHTFA407	460/3/60	7.5	25,600	1	EBC*A4*
BAYHTFA410	460/3/60	10	34,200	1	EBC*A4*
BAYHTFA415	460/3/60	15	51,200	1	EBC*A4*
BAYHTFA420	460/3/60	20	68,300	2	EBC048A4*, EBC060A4*
BAYHTFA425	460/3/60	25	85,400	2	EBC060A4*
BAYHTFAW10	575/3/60	10	34,200	1	EBC*AW*
BAYHTFAW15	575/3/60	15	51,200	1	EBC*AW*
BAYHTFAW20	575/3/60	20	68,300	2	EBC048AW*, EBC060AW*
BAYHTFAW25	575/3/60	25	85,400	2	EBC060AW*

ONLINE ONLY

Light Commercial
Packaged Cooling



It's Hard To Stop A Trane.®

Medium Foundation™ Packaged Cooling 7.5-12.5 Tons, R-410A



- Scroll compressors on all units
- Operating charge of R-410A
- Low ambient operation to 40°F as standard
- Color coded and numbered wiring
- Single side service access
- Molded handles on service access doors
- Separated high and low voltage compartments
- Liquid Line Refrigerant Drier
- Provisions for through the base connections
- Phase monitor on all units
- Convertible airflow
- Two inch throwaway filters as standard
- Non-corrosive & removable drain pan
- **5-year limited compressor warranty (7.5 - 12.5 tons)**

Table LPC-20-A – Foundation™ – R-410A – Electromechanical Controls - 2-Speed Fan

Tons	Unit Model No.	Power Supply Volts/Phase/Hz	Performance IEER	Cooling Capacity (Btuh)	Dimensions (in.) H x W x L	Shipping Weight (lbs.)	MCA	Max Fuse Size or Max Circuit Breaker [Ⓞ]	Downflow Roofcurb
ECC* - Three Phase No Heat									
7½	ECC090A3E0A3YXA*	208-230/3/60			44 x 58¾ x 88¾	999	37	50	BAYCURB310
8½	ECC102A3E0A3YXA*	208-230/3/60			49⅞ x 58¾ x 88¾	1073	40	50	BAYCURB310
10	ECC120A3E0A3YXA*	208-230/3/60			49⅞ x 58¾ x 88¾	1144	54	70	BAYCURB310
12½	ECC150A3E0A3YXA*	208-230/3/60			49⅞ x 58¾ x 88¾	1246	62	80	BAYCURB310
7½	ECC090A4E0A3YXA*	460/3/60			44 x 58¾ x 88¾	999	22	25	BAYCURB310
8½	ECC102A4E0A3YXA*	460/3/60			49⅞ x 58¾ x 88¾	1073	23	30	BAYCURB310
10	ECC120A4E0A3YXA*	460/3/60			49⅞ x 58¾ x 88¾	1144	27	35	BAYCURB310
12½	ECC150A4E0A3YXA*	460/3/60			49⅞ x 58¾ x 88¾	1246	31	40	BAYCURB310

Ⓞ HACR Circuit Breaker Type Per NEC.

3YXA medium Foundation models include multi-speed motor .

Information subject to change. Please confirm with current Product Data for current factory production.

Light Commercial Packaged Cooling



It's Hard To Stop A Trane.®

Medium Foundation™ Packaged Cooling 7.5-12.5 Tons, R-410A (Model Digit Numbers)

Digit	Description	Order Number	Digit	Description	Order Number
1	Unit Function Packaged Cooling, Electric Heat	E	14	Fresh Air Selection ⓐⓑ	
2	Efficiency Generation C - DOE	C		No Fresh Air	0
3	Airflow Configuration Convertible	C	15	Supply Fan/Drive Type/Motor	
4,5,6	Nominal Gross Cooling Capacity (MBh)			Multi-Speed Standard Motor	7
	7.5 Ton	090		Multi-Speed Oversized Motor	9
	8.5 Ton	102	16	Unit Type	
	10 Ton	120		Medium Foundation	M
	12.5 Ton	150	17	Condenser Coil Protection	
7	Design Sequence	*		Standard Coil	0
8	Voltage		18	Through the Base Provisions	
	208-230/60/3	3		No Through-the Base-Provisions	0
	460/60/3	4	19	Disconnect/Circuit Breake (3 phase only)	
9	Unit Controls			No Disconnect/Circuit Breaker	0
	Electromechanical	E	20-24	Not Used	
10	Heating Capacity			No Convenience Outlet	0000
	Cooling Only	0	25	System Monitoring Controls 1	
11	Minor Design Sequence	*		No Monitoring Controls	0
12-13	Service Sequence	**	26	System Monitoring Controls 2	
				Economizer Fault Detection and Diagnostics (FDD)Ⓒ	B

- ⓐ Some field set up required
- ⓑ Must be ordered through the base electrical option
- ⓒ All factory installed Options are Built-to-Order. Check order services for estimated production cycle
- ⓓ Factory installed economizers only available in downflow configuration
- Ⓒ Fault Detection and Diagnostics (FDD) is available on Low Leak Economizers only

Light Commercial
Packaged Cooling



Medium Foundation™ Packaged Cooling 7.5 - 12.5 Tons Accessories

Table LPC-22-A — Foundation™ - R-410A - Field Installed Accessories

Model Number	Description	Used With
BAYTBUE310	Through the Base Electrical Connections	All Foundation 15-25 Ton Units
BAYDSCF300	Unit Mounted Disconnect, 100 Amp Not for use when electric heat installed	ECC090* - ECC150
BBAYDSCF302	Unit Mounted Disconnect, 100 Amp	BAYHTFA318A, BAYHTFA418A, BAYHTFAW18A, BAYHTFA436A, BAYHTFA454A, BAYHTFBW36A, BAYHTFAW54A, BAYHTFBW54A, BAYHTFBW72A, BAYHTFAW72A
BAYDSCF303	Unit Mounted Disconnect, 150 Amp	BAYHTFA472A, BAYHTF4372A, BAYHTFA336A, BAYHTFB336A, BAYHTFB454A
BAYDSCF304	Unit Mounted Disconnect, 250 Amp	BAYHTFA372A, BAYHTFB372A, BAYHTFA354A, BAYHTFAW36A
BAYDMPR311	Damper, Manual	ECC090A* - ECC150A*
BAYDMPR310	Damper, Motorized	ECC090A* - ECC150A*
BAYECON310	Economizer, Dry Bulb, Downflow	ECC090A* - ECC150A*
BAYECON311	Economizer, Dry Bulb, Horizontal	ECC090A* - ECC150A*
BAYECON355	Low Leak Economizer w/FDD, Dry Bulb, Downflow	ECC090A* - ECC150A*
BAYECON356	Low Leak Economizer w/FDD, Dry Bulb, Horizontal	ECC090A* - ECC150A*
BAYBARO310	Barometric Relief Damper, 7.5 - 12.5T	ECC090A* - ECC150A*
BAYENTH310	Reference Enthalpy Economizer Kit	ECC090A* - ECC150A*
BAYENTH311	Comparative Enthalpy Economizer Kit	ECC090A* - ECC150A*
BAYENTH312	Reference Enthalpy Economizer Kit	ECC090A* - ECC150A* w/Low Leak Economizer & FDD
BAYENTH313	Comparative Enthalpy Economizer Kit	ECC090A* - ECC150A* w/Low Leak Economizer & FDD
BAYCURB310	Roof Curb	ECC090A* - ECC150A*
BAYGARD310	Condenser Hail Guard	ECC090A
BAYGARD311	Condenser Hail Guard	ECC102A* ECC150A*
BAYCCHT300	Crankcase Heater, 70W, 230V	ECC1B0A3* - ECC300A3*
BAYCCHT301	Crankcase Heater, 70W, 460V	ECC1B0A4* - ECC300A4*
BAYCCHT302	Crankcase Heater, 70W, 575V	ECC1B0AW* - ECC300AW*
BAYASCT001	Compressor Short Cycle Timer	ECC090A* - ECC150A
BAYLOAM300	Low Ambient Control	EBC180A* - EBC300A*
BAYLOAM310	Evaporator Defrost Control	EBC180A* - EBC300A*
BAYPWRX310	Power Exhaust, 15-25T, DF, 230V	ECC090A3* - ECC150A3*
BAYPWRX311	Power Exhaust, 15-25T, DF, 460V	ECC090A4* - ECC150A4*
BAYPWRX312	Power Exhaust, 15-25T, DF, 575V	ECC090AW* - ECC150AW*
BAYHSDR300	High Static Drive Option	EBC180A* - EBC300A*
BAYCO2K300	Wall Mounted CO2 Sensor	ECC090A* - ECC150A* with economizer
BAYCO2K301	Duct Mounted CO2 Sensor	ECC090A* - ECC150A* with economizer
BAYCOSW300	Drain Pan Overflow Switch	ECC090A* - ECC150A*
BAYSTAT300	BACNet Enabled Thermostat	EBC180A* - EBC300A*

① Please check availability.

② See HVAC Knowledge Center for a list of compatible Carrier units.

③ FDD = Fault Detection & Diagnostics.

Information subject to change. Please confirm with current Product Data for current factory production.

Light Commercial
Packaged Cooling



It's Hard To Stop A Trane.®

Medium Foundation™ Packaged Cooling 7.5 - 12.5 Tons Heaters

Table LPC-23-A – Foundation™ - R-410A - Field Installed Accessories

Model Number	Power Supply	kW Rating	Nominal BTUH	No. Stages	Used With
EHK-10CUL	208-230/3/60	10.4	35490	1	ECC090A3* - ECC150A3*
EHK-15CUL	208-230/3/60	16	54590	1	ECC090A3* - ECC150A3*
EHK-25CUL	208-230/3/60	25	85300	1	ECC090A3* - ECC150A3*
EHK-32CUL	208-230/3/60	32	109190	2	ECC090A3* - ECC150A3*
EHK-41CUL	208-230/3/60	41	139900	2	ECC090A3* - ECC150A3*
EHK-50CUL	208-230/3/60	50	170610	2	ECC120A3* - ECC150A3*
EHK-14FUL	460/3/60	13.9	47427	1	ECC090A4* - ECC150A4*
EHK-16FUL	460/3/60	16.5	56298	1	ECC090A4* - ECC150A4*
EHK-25FUL	460/3/60	25	85300	1	ECC090A4* - ECC150A4*
EHK-33FUL	460/3/60	33	112596	2	ECC090A4* - ECC150A4*
EHK-41FUL	460/3/60	41.5	141598	2	ECC090A4* - ECC150A4*
EHK-50FUL	460/3/60	50	170600	2	ECC120A4* - ECC150A4*

Information subject to change. Please confirm with current Product Data for current factory production.

ONLINE ONLY COPY

Light Commercial
Packaged Cooling



It's Hard To Stop A Trane.®

Foundation™ Packaged Cooling 15-25 Tons, R-410A



- Scroll compressors on all units
Provisions for through the base
- Operating charge of R-410A connections
- Low ambient operation to 40°F as standard
Phase monitor on all units
- Color coded and numbered wiring
Convertible airflow
- Single side service access
Two inch throwaway filters as standard
- Molded handles on service access doors
Non-corrosive & removable drain pan
- Separated high and low voltage
- Liquid Line Refrigerant Drier
- 5-year limited compressor warranty (15-25 tons)

Table PC-24-B – Foundation™ – R-410A – Electromechanical Controls - 2-Speed Fan

Tons	Unit Model No.	Power Supply Volts/Phase/Hz	Performance (EER/IEER)	Cooling Capacity (Btuh)	Dimensions (in.) H x W x L	Shipping Weight (lbs.)	MCA	Max Fuse Size or Max Circuit Breaker [ⓐ]	Downflow Roofcurb
ECC* - Three Phase No Heat									
15	ECC180A3E0A1DQY	208-230/3/60	11.0/14.2	194,000	58 ⁵ / ₈ x 86 ¹⁵ / ₁₆ x 123 ¹ / ₈	2146	75	100	BAYCURB027B
17½	ECC210A3E0A1DQY	208-230/3/60	11.0/14.2	214,000	58 ⁵ / ₈ x 86 ¹⁵ / ₁₆ x 123 ¹ / ₈	2155	86	110	BAYCURB027B
20	ECC240A3E0A1DQY	208-230/3/60	10.0/13.2	252,000	58 ⁵ / ₈ x 86 ¹⁵ / ₁₆ x 123 ¹ / ₈	2180	97	125	BAYCURB027B
25	ECC300A3E0A1DQY	208-230/3/60	10.0/13.2	280,000	58 ⁵ / ₈ x 86 ¹⁵ / ₁₆ x 123 ¹ / ₈	2206	126	175	BAYCURB027B
<hr/>									
15	ECC180A4E0A1DQY	460/3/60	11.0/14.2	194,000	58 ⁵ / ₈ x 86 ¹⁵ / ₁₆ x 123 ¹ / ₈	2146	35	45	BAYCURB027B
17½	ECC210A4E0A1DQY	460/3/60	11.0/14.2	214,000	58 ⁵ / ₈ x 86 ¹⁵ / ₁₆ x 123 ¹ / ₈	2155	42	50	BAYCURB027B
20	ECC240A4E0A1DQY	460/3/60	10.0/13.2	252,000	58 ⁵ / ₈ x 86 ¹⁵ / ₁₆ x 123 ¹ / ₈	2180	46	60	BAYCURB027B
25	ECC300A4E0A1DQY	460/3/60	10.0/13.2	280,000	58 ⁵ / ₈ x 86 ¹⁵ / ₁₆ x 123 ¹ / ₈	2206	53	70	BAYCURB027B
<hr/>									
15	ECC180AWE0A1DQY	575/3/60	11.0/14.2	194,000	58 ⁵ / ₈ x 86 ¹⁵ / ₁₆ x 123 ¹ / ₈	2146	28	35	BAYCURB027B
17½	ECC210AWE0A1DQY	575/3/60	11.0/14.2	214,000	58 ⁵ / ₈ x 86 ¹⁵ / ₁₆ x 123 ¹ / ₈	2155	34	45	BAYCURB027B
20	ECC240AWE0A1DQY	575/3/60	10.0/13.2	252,000	58 ⁵ / ₈ x 86 ¹⁵ / ₁₆ x 123 ¹ / ₈	2180	38	50	BAYCURB027B
25	ECC300AWE0A1DQY	575/3/60	10.0/13.2	280,000	58 ⁵ / ₈ x 86 ¹⁵ / ₁₆ x 123 ¹ / ₈	2206	44	50	BAYCURB027B

ⓐ HACR Circuit Breaker Type Per NEC.

1DQY models include a multi-speed motor.

Information subject to change. Please confirm with current Product Data for current factory production.

Light Commercial
Packaged Cooling



It's Hard To Stop A Trane.®

Foundation™ Packaged Cooling 15-25 Tons, R-410A (Model Digit Numbers)

Digit	Description	Order Number	Digit	Description	Order Number
1	Unit Function		15	Supply Fan/Drive Type/Motor	
	Packaged Cooling, Electric Heat	E		Multi-Speed Standard Motor.....	7
2	Efficiency			Multi-Speed Oversized Motor	9
	Generation B.....	B	16	Access	
	Generation C - DOE.....	C		Standard Fork Access	0
3	Airflow Configuration			Third Side Condenser Fork Access (15-25 Tons)	F
	Convertible.....	C	17	Condenser Coil Protection	
4,5,6	Nominal Gross Cooling Capacity (MBh)			Standard Coil	0
	3 Ton.....	036		Condenser with CompleteCoat™	4
	4 Ton.....	048	18	Through the Base Provisions	
	5 Ton.....	060		No Through-the-Base-Provisions	0
	15 Ton.....	180		Through-the-Base Electric	A
	17.5 Ton.....	210	19	Disconnect/Circuit Breake (3 phase only)	
	20 Ton.....	240		No Disconnect/Circuit Breaker	0
	25 Ton.....	300		Unit Mounted/Non-Fused Disconnect®	1
7	Design Sequence	*	20-24	Not Used	
8	Voltage			No Convenience Outlet	0000
	208-230/60/3	3	25	System Monitoring Controls 1	
	460/60/3	4		No Monitoring Controls	0
	575/60/3	W		Condensate Drain Pan Overflow Switch.....	A
9	Unit Controls		26	System Monitoring Controls 2	
	Electromechanical	E		Economizer Fault Detection and Diagnostics (FDD)®	B
10	Heating Capacity				
	No Heat	0			
	5 kW Electric Heat	A			
	7.5 kW Electric Heat	B			
	10 kW Electric Heat	C			
	14.4 kW Electric Heat	D			
	20 kW Electric Heat	E			
	25 kW Electric Heat	F			
	18 kW Electric Heat	G			
	36 kW Electric Heat	N			
	54 kW Electric Heat	P			
	72 kW Electric Heat	R			
11	Design Sequence	*			
12-13	Service Sequence	*,*			
14	Fresh Air Selection				
	No Fresh Air	0			
	Manual Outside Air Damper 0-25%	A			
	Motorized Outside Air Damper 0-50%	B			
	Economizer, Dry Bulb 0-100% without Barometric Relief.....	C			
	Economizer, Dry Bulb 0-100% with Barometric Relief①.....	D			
	Economizer, Reference Enthalpy 0-100% without Barometric Relief.....	E			
	Economizer, Reference Enthalpy 0-100% with Barometric Relief①	F			
	Economizer, Comparative Enthalpy 0-100% without Barometric Relief.....	G			
	Economizer, Comparative Enthalpy 0-100% with Barometric Relief①	H			
	Downflow Low Leak Economizer, Dry Bulb without Barometric Relief.....	J			
	Downflow Low Leak Economizer, Reference Enthalpy without Barometric Relief.....	L			
	Downflow Low Leak Economizer, Comparative Enthalpy without Barometric Relief.....	N			

- ① Some field set up required
- ② Must be ordered through the base electrical option
- ③ All factory installed Options are Built-to-Order. Check order services for estimated production cycle
- ④ Factory installed economizers only available in downflow configuration
- ⑤ Fault Detection and Diagnostics (FDD) is available on Low Leak Economizers only

Light Commercial Packaged Cooling

For complete equipment / combination selections, installation instructions and warranty information, please refer to Product Data/Ratings and/or Installers Guides and Limited Warranty Handbooks.



Foundation™ Packaged Cooling 15-25 Tons Accessories

Table LPC-26-A — Foundation™ - R-410A - Field Installed Accessories

Model Number	Description	Used With
BAYTBUE300	Through the Base Electrical Connections	All Foundation 15-25 Ton Units
BAYDSCF300	Unit Mounted Disconnect, 100 Amp Not for use when electric heat installed	ECC180A4* - ECC300A4*, ECC180AW* - ECC300AW*
BAYDSCF301	Unit Mounted Disconnect, 150 Amp	ECC180A3* - ECC300A3*
BAYDSCF302	Unit Mounted Disconnect, 100 Amp	BAYHTFA318A, BAYHTFA418A, BAYHTFAW18A, BAYHTFA436A, BAYHTFA454A, BAYHTFBW36A, BAYHTFAW54A, BAYHTFBW54A, BAYHTFA472A, BAYHTF4372A, BAYHTFA336A, BAYHTFB336A, BAYHTFB454A
BAYDSCF303	Unit Mounted Disconnect, 150 Amp	BAYHTFA372A, BAYHTFB372A, BAYHTFA354A, BAYHTFB36A
BAYDSCF304	Unit Mounted Disconnect, 250 Amp	BAYHTFAW36A
BAYDMPR301	Damper, Manual	ECC180A* - ECC300A*
BAYDMPR300	Damper, Motorized	ECC180A* - ECC300A*
BAYECON300	Economizer, Dry Bulb, Downflow	ECC180A* - ECC300A*
BAYECON301	Economizer, Dry Bulb, Horizontal	ECC180A* - ECC300A*
BAYECON350	Low Leak Economizer w/FDD, Dry Bulb, Downflow	ECC180A* - ECC300A*
BAYECON351	Low Leak Economizer w/FDD, Dry Bulb, Horizontal	ECC180A* - ECC300A*
BAYHZCN300	Horizontal Economizer Conversion Kit	ECC180A* - ECC300A*
BAYBARO300	Barometric Relief Damper, 15-25T	ECC180A* - ECC300A*
BAYENTH300	Reference Enthalpy Economizer Kit	ECC180A* - ECC300A*
BAYENTH301	Comparative Enthalpy Economizer Kit	ECC180A* - ECC300A*
BAYENTH302	Reference Enthalpy Economizer Kit	ECC180A* - ECC300A* w/Low Leak Economizer & FDD
BAYENTH303	Comparative Enthalpy Economizer Kit	ECC180A* - ECC300A* w/Low Leak Economizer & FDD
BAYCURB027	Roof Curb	ECC180A* - ECC300A*
BAYHZRT001	Horizontal Duct Conversion Kit	ECC180A* - ECC300A*
BAYCARR001	Carrier Replacement Conversion Kit	ECC180A* - ECC300A*
BAYGARD300	Condenser Hail Guard	ECC180A* - ECC300A*
BAYCCHT300	Crankcase Heater, 70W, 230V	ECC180A3* - ECC300A3*
BAYCCHT301	Crankcase Heater, 70W, 460V	ECC180A4* - ECC300A4*
BAYCCHT302	Crankcase Heater, 70W, 575V	ECC180AW* - ECC300AW*
BAYASC001	Compressor Short Cycle Timer	ECC180A* - ECC300A*
BAYLOAM300	Low Ambient Control	ECC180A* - ECC300A*
BAYLOAM310	Evaporator Defrost Control	ECC180A* - ECC300A*
BAYPWRX300	Power Exhaust, 15-25T, DF, 230V	ECC180A3* - ECC300A3*
BAYPWRX301	Power Exhaust, 15-25T, DF, 460V	ECC180A4* - ECC300A4*
BAYPWRX302	Power Exhaust, 15-25T, DF, 575V	ECC180AW* - ECC300AW*
BAYHSMT300	High Static Motor & Drv, 5HP 230/460V	ECC180A3, ECC180A4
BAYHSMT301	High Static Motor & Drv, 5HP 575V	ECC1 80AW
BAYHSMT302	High Static Motor & Drv, 7.5HP 230/460V	ECC210A3, ECC240A3
BAYHSMT303	High Static Motor & Drv, 7.5HP 460V	ECC210A4, ECC240A4
BAYHSMT304	High Static Motor & Drv, 7.5HP 575V	ECC210AW, ECC240AW
BAYSHGR003	Shaft Grounding Ring, 0.875" Shaft	Used With 5HP VFD Motors
BAYSHGR002	Shaft Grounding Ring, 1.125" Shaft	Used With 7.5HP VFD Motors
BAYLSDR300	Low Static Drive Option	ECC180A* - ECC300A*
BAYHSDR300	High Static Drive Option	ECC180A* - ECC300A*
BAYCO2K300	Wall Mounted CO2 Sensor	ECC180A* - ECC300A* with economizer
BAYCO2K301	Duct Mounted CO2 Sensor	ECC180A* - ECC300A* with economizer
BAYPALT001	Reuseable Pallet for Condenser End Unit Lifting	All Foundation 15-25 Ton Units
BAYCOSW300	Drain Pan Overflow Switch	ECC180A* - ECC300A*
BAYSTAT300	BACNet Enabled Thermostat	ECC180A* - ECC300A*

① Please check availability.

② See HVAC Knowledge Center for a list of compatible Carrier units.

③ FDD = Fault Detection & Diagnostics.

Information subject to change. Please confirm with current Product Data for current factory production.



It's Hard To Stop A Trane.®

Foundation™ Packaged Cooling 15-25 Tons Heaters

Table LPC-27-A – Foundation™ - R-410A - Field Installed Accessories

Model Number	Power Supply	KW Rating	Nominal BTUH	No. Stages	Used With
BAYHTFB318A	208-230/3/60	13/5/18	46,100/64,400	1	ECC180A3
BAYHTFC336A	208-230/3/60	27/36	92,200/122,900	2	ECC180A3, ECC210A3
BAYHTFC354A	208-230/3/60	27/36	92,200/122,900	2	ECC180A3, ECC210A3
BAYHTFC372A	208-230/3/60	40.5/54	138,200/184,300	2	ECC210A3
BAYHTFD336A	208-230/3/60	40.5/54	138,200/184,300	2	ECC240A3, ECC300A3
BAYHTFD354A	208-230/3/60	54/72	184,300/245,700	2	ECC240A3, ECC300A3
BAYHTFD372A	208-230/3/60	54/72	184,300/245,700	2	ECC240A3, ECC300A3
BAYHTFB418A	460/3/60	18	64000	1	ECC180A4
BAYHTFC436A	460/3/60	36	122900	2	ECC180A4, ECC210A4
BAYHTFC454A	460/3/60	36	122900	2	ECC180A4, ECC210A4
BAYHTFC472A	460/3/60	54	184300	2	ECC210A4
BAYHTFD436A	460/3/60	54	184300	2	ECC240A4, ECC300A4
BAYHTFD454A	460/3/60	72	245700	2	ECC240A4, ECC300A4
BAYHTFD472A	460/3/60	72	245700	2	ECC240A4, ECC300A4
BAYHTFBW18A	575/3/60	18	64000	1	ECC180AW
BAYHTFCW36A	575/3/60	36	122900	2	ECC180AW, ECC210AW
BAYHTFCW54A	575/3/60	36	122900	2	ECC180AW, ECC210AW
BAYHTFCW72A	575/3/60	54	184300	2	ECC210AW
BAYHTFDW36A	575/3/60	54	184300	2	ECC240AW, ECC300AW
BAYHTFDW54A	575/3/60	72	245700	2	ECC240AW, ECC300AW
BAYHTFDW72A	575/3/60	72	245700	2	ECC240AW, ECC300AW

Information subject to change. Please confirm with current Product Data for current factory production.

ONLINE ONLY

Light Commercial
Packaged Cooling



It's Hard To Stop A Trane.®



Beveled Top
Smoother Design
Small compact cabinet
Recessed access handles

Precedent™ Packaged Heat Pump Convertible 3-10 Tons

Standard Features:

- Trane scroll compressors on all 3-10 ton units
- ReliaTel™ Controls (See page LPC-12 for ReliaTel™ Control Information)
- Thermal Expansion Valve
- Colored and numbered wiring
- Phase Monitor, 3 Phase Units
- Provisions for through the Base Condensate Drain Connections
- Crankcase Heaters
- Patented Hybrid Condenser Coil for easy cleaning
- 2" throwaway filters provided on 3-10 ton units
- Liquid Line Refrigerant Drier
- Operating Charge of R-410A
- IAQ Sloped Drain Pans
- Single point power for electric Heat
- Low Ambient cooling to 0°F
- Anti-Short Cycle Timer (Standard with ReliaTel™)
- 5 - year Limited Compressor Warranty
- 1 - year Limited Parts Warranty

Added Flexibility

- New 3-5 Ton Dual Fuel Models
- Convertible airflow
- Fork lift openings on three sides of unit
- Direct or belt drive - standard or oversized motors
- We don't prepackage options
- Choose options tailored to suit each job — pay only for what is needed
- Units ship with options installed — and within our standard ship cycle time

Factory Installed Options

- Through-the-Base — Electrical
- Convenience Outlet — Powered or unpowered
- Unit Disconnect Switch
- Circuit Breaker
- Smoke Detectors — Supply, return, or both
- Condenser Coil Coating
- Hinged Access Service Panels
- Discharge Air Sensor
- Fan Fail and Clogged Filter Switches
- Condenser Coil Guard — Hail Protection Quality
- TCI (Trane Communications Interface)
- LonTalk® (Communications Interface)
- BACnet™ (Communications Interface)
- Froststat
- 2" MERV 8 filters or 2" MERV 13 filters
- Black Epoxy Pre-Coated Coils
- Multi-Speed & Single Zone VAV ID Airflow
- Demand Control Ventilation
- Stainless Steel Drainpan
- Condensate Drainpan Overflow Switch

The same Trane Quality and Reliability ... with added Flexibility!

For complete equipment / combination selections, installation instructions and warranty information, please refer to Product Data/Ratings and/or Installers Guides and Limited Warranty Handbooks.

LPH-1

Effective 1/1/23
22-8301-36



It's Hard To Stop A Trane.®

Precedent™ Packaged Heat Pump Convertible 3-10 Tons, R-410A

Table LPH-2-A — High Efficiency Unit — ReliaTel™ Microprocessor Controls

Tons	Unit Ordering No.	Performance ^② SEER/HSPF	Cooling Capacity (Btuh)	Cabinet Dimensions (in.) H x D x W	Downflow Supply	Downflow Return	Shipping Weight (lbs.)	MCA*	Max ^① Fuse*
WHC - 208-230/3/60 - Three Phase - No Electric Heat									
3	WHC036H3R0B005D	15.8 / 8.3	40,500	41 x 44 x 69	18 x 15.5	24 x 14	619	23	30
4	WHC048H3R0A005D	16.5 / 8.8	48,750	41 x 53 x 88	33 x 17.5	32 x 17.5	768	29	40
5	WHC060H3R0A005D	16.4 / 9.0	61,000	41 x 53 x 88	33 x 17.5	32 x 17.5	773	32	45
6	WHC074H3R0A005D	15.5	78,900	47 x 53 x 88	33 x 17.5	32 x 17.5	927	42	50
7.5	WHC092H3R0A005D	15.5	96,200	47 x 53 x 88	33 x 17.5	32 x 17.5	927	43	50
8.5	WHC102H3R0A005D	15.5	105,900	47 x 53 x 88	33 x 17.5	32 x 17.5	953	46	60
10	WHC120H3R0A005D	15.5	123,600	51 x 63 x 100	33 x 17.5	32 x 17.5	1433	49	60
WHC - 460/3/60 - Three Phase - No Electric Heat									
3	WHC036H4R0B005D	15.7 / 8.3	40,500	41 x 44 x 69	18 x 15.5	24 x 14	619	13	15
4	WHC048H4R0A005D	16.5 / 8.8	48,750	41 x 53 x 88	33 x 17.5	32 x 17.5	768	14	15
5	WHC060H4R0A005D	16.2 / 9.0	61,000	41 x 53 x 88	33 x 17.5	32 x 17.5	773	15	20
6	WHC074H4R0A005D	15.5	78,900	47 x 53 x 88	33 x 17.5	32 x 17.5	927	19	25
7.5	WHC092H4R0A005D	15.5	96,200	47 x 53 x 88	33 x 17.5	32 x 17.5	927	20	25
8.5	WHC102H4R0A005D	15.5	105,900	47 x 53 x 88	33 x 17.5	32 x 17.5	953	22	25
10	WHC120H4R0A005D	15.5	123,600	51 x 63 x 100	33 x 17.5	32 x 17.5	1433	24	30
WHC - 575/3/60 - Three Phase - No Electric Heat									
3	WHC036HWR0B005D	15.7 / 8.3	40,500	41 x 44 x 69	18 x 15.5	24 x 14	619	9	15
4	WHC048HWR0A005D	16.5 / 8.8	48,750	41 x 53 x 88	33 x 17.5	32 x 17.5	768	10	15
5	WHC060HWR0A005D	16.2 / 9.0	61,000	41 x 53 x 88	33 x 17.5	32 x 17.5	773	12	15
6	WHC074HWR0A005D	15.5	78,900	47 x 53 x 88	33 x 17.5	32 x 17.5	927	21	25
7.5	WHC092HWR0A005D	15.5	96,200	47 x 53 x 88	33 x 17.5	32 x 17.5	927	22	25
8.5	WHC102HWR0A005D	15.5	105,900	47 x 53 x 88	33 x 17.5	32 x 17.5	953	23	25
10	WHC120HWR0A005D	15.5	123,600	51 x 63 x 100	33 x 17.5	32 x 17.5	1433	23	30

Table LPH-2-B — High Efficiency Dual Fuel Unit — ReliaTel™ Microprocessor Controls

Tons	Unit Ordering No.	Performance ^② SEER/HSPF	Cooling Capacity (Btuh)	Gas Heating Output Capacity (Btuh) (2nd / 1st stage)	S.S. Furnace Eff%	Cabinet Dimensions (in.) H x D x W	Downflow Supply	Downflow Return	Shipping Weight (lbs.)	MCA*	Max ^① Fuse*
DHC - 208-230/3/60 - Three Phase - Low Heat											
3	DHC036H3RLB005D	15.7 / 8.3	40,500	48,600 / 34,200	81%	41 x 44 x 69	18 x 15.5	24 x 14	658	23	30
4	DHC048H3RLA005D	16.5 / 8.8	48,750	48,600 / 34,200	81%	41 x 53 x 88	33 x 17.5	32 x 17.5	845	29	40
5	DHC060H3RLA005D	16.2 / 8.9	61,000	48,600 / 34,200	81%	41 x 53 x 88	33 x 17.5	32 x 17.5	849	32	45
6	DHC074H3RLA005D	15.5	78,900	64,800	81%	47 x 53 x 88	33 x 17.5	32 x 17.5	990	42	50
7.5	DHC092H3RLA005D	15.5	96,200	97,200	81%	47 x 53 x 88	33 x 17.5	32 x 17.5	1004	43	50
8.5	DHC102H3RLA005D	15.5	105,900	97,200	81%	47 x 53 x 88	33 x 17.5	32 x 17.5	1016	46	60
10	DHC120H3RLA005D	15.5	123,600	121,500/85,050	81%	51 x 63 x 100	33 x 17.5	32 x 17.5	1499	49	60
DHC - 460/3/60 - Three Phase - Low Heat											
3	DHC036H4RLB005D	15.6 / 8.3	40,500	48,600 / 34,200	81%	41 x 44 x 69	18 x 15.5	24 x 14	658	13	15
4	DHC048H4RLA005D	16.5 / 8.8	48,750	48,600 / 34,200	81%	41 x 53 x 88	33 x 17.5	32 x 17.5	845	14	15
5	DHC060H4RLA005D	16.0 / 8.9	61,000	48,600 / 34,200	81%	41 x 53 x 88	33 x 17.5	32 x 17.5	849	15	20
6	DHC074H4RLA005D	15.5	78,900	64,800	81%	47 x 53 x 88	33 x 17.5	32 x 17.5	990	19	25
7.5	DHC092H4RLA005D	15.5	96,200	97,200	81%	47 x 53 x 88	33 x 17.5	32 x 17.5	1004	20	25
8.5	DHC102H4RLA005D	15.5	105,900	97,200	81%	47 x 53 x 88	33 x 17.5	32 x 17.5	1016	22	25
10	DHC120H4RLA005D	15.5	123,600	121,500/85,050	81%	51 x 63 x 100	33 x 17.5	32 x 17.5	1499	24	30
DHC - 575/3/60 - Three Phase - Low Heat											
3	DHC036HWRLB005D	15.6 / 8.3	40,500	48,600 / 34,200	81%	41 x 44 x 69	18 x 15.5	24 x 14	658	9	15
4	DHC048HWRLA005D	16.5 / 8.8	48,750	48,600 / 34,200	81%	41 x 53 x 88	33 x 17.5	32 x 17.5	845	10	15
5	DHC060HWRLA005D	16.0 / 8.9	61,000	48,600 / 34,200	81%	41 x 53 x 88	33 x 17.5	32 x 17.5	849	12	15
6	DHC074HWRLA005D	15.5	78,900	64,800	81%	47 x 53 x 88	33 x 17.5	32 x 17.5	990	21	25
7.5	DHC092HWRLA005D	15.5	96,200	97,200	81%	47 x 53 x 88	33 x 17.5	32 x 17.5	1004	22	25
8.5	DHC102HWRLA005D	15.5	105,900	97,200	81%	47 x 53 x 88	33 x 17.5	32 x 17.5	1016	23	25
10	DHC120HWRLA005D	15.5	123,600	121,500/85,050	81%	51 x 63 x 100	33 x 17.5	32 x 17.5	1499	23	30

* Information subject to change. Please confirm with current Product Data/Service Facts for current factory production.

① HCAR breaker per NEC.

② SEER applies, 3-5 tons; HSPF applies 6-10 tons.

For complete equipment / combination selections, installation instructions and warranty information, please refer to Product Data/Ratings and/or Installer Guides and Limited Warranty Handbooks.



It's Hard To Stop A Trane.®

Precedent™ Packaged Heat Pump Convertible 3-10 Tons, R-410A

Table LPH-3-A – High Efficiency Dual Fuel Unit – ReliaTel™ Microprocessor Controls (Continued)

Tons	Unit Ordering No.	Performance ^② SEER/HSPF	Cooling Capacity (Btuh)	Gas Heating Output Capacity (Btuh) (2nd / 1st stage)	S.S. Furnace Eff%	Cabinet Dimensions (in.) H x D x W	Downflow Supply	Downflow Return	Shipping Weight (lbs.)	MCA*	Max ^① Fuse*
DHC - 208-230/3/60 - Three Phase - Medium Heat											
3	DHC036H3RMB005D	15.7 / 8.3	40,500	64,800 / 45,360	81%	41 x 44 x 69	18 x 15.5	24 x 14	658	23	30
4	DHC048H3RMA005D	16.5 / 8.8	48,750	81,000 / 56,700	81%	41 x 53 x 88	33 x 17.5	32 x 17.5	845	29	40
5	DHC060H3RMA005D	16.2 / 8.9	61,000	81,000 / 58,320	81%	41 x 53 x 88	33 x 17.5	32 x 17.5	849	32	45
6	DHC074H3RMA005D	15.5	78,900	97,200	81%	47 x 53 x 88	33 x 17.5	32 x 17.5	990	42	50
7.5	DHC092H3RMA005D	15.5	96,200	121,500/85,050	81%	47 x 53 x 88	33 x 17.5	32 x 17.5	1004	43	50
8.5	DHC102H3RMA005D	15.5	105,900	121,500/85,050	81%	47 x 53 x 88	33 x 17.5	32 x 17.5	1016	46	60
10	DHC120H3RMA005D	15.5	123,600	162,000/113,400	81%	51 x 63 x 100	33 x 17.5	32 x 17.5	1499	49	60
DHC - 460/3/60 - Three Phase - Medium Heat											
3	DHC036H4RMB005D	15.6 / 8.3	40,500	64,800 / 45,360	81%	41 x 44 x 69	18 x 15.5	24 x 14	658	13	15
4	DHC048H4RMA005D	16.5 / 8.8	48,750	81,000 / 56,700	81%	41 x 53 x 88	33 x 17.5	32 x 17.5	845	14	15
5	DHC060H4RMA005D	16.0 / 8.9	61,000	81,000 / 58,320	81%	41 x 53 x 88	33 x 17.5	32 x 17.5	849	15	20
6	DHC074H4RMA005D	15.5	78,900	97,200	81%	47 x 53 x 88	33 x 17.5	32 x 17.5	990	19	25
7.5	DHC092H4RMA005D	15.5	96,200	121,500/85,050	81%	47 x 53 x 88	33 x 17.5	32 x 17.5	1004	20	25
8.5	DHC102H4RMA005D	15.5	105,900	121,500/85,050	81%	47 x 53 x 88	33 x 17.5	32 x 17.5	1016	22	25
10	DHC120H4RMA005D	15.5	123,600	162,000/113,400	81%	51 x 63 x 100	33 x 17.5	32 x 17.5	1499	24	30
DHC - 575/3/60 - Three Phase - Medium Heat											
3	DHC036HWRMB005D	15.6 / 8.3	40,500	64,800 / 45,360	81%	41 x 44 x 69	18 x 15.5	24 x 14	658	9	15
4	DHC048HWRMA005D	16.5 / 8.8	48,750	81,000 / 56,700	81%	41 x 53 x 88	33 x 17.5	32 x 17.5	845	10	15
5	DHC060HWRMA005D	16.0 / 8.9	61,000	81,000 / 58,320	81%	41 x 53 x 88	33 x 17.5	32 x 17.5	849	12	15
6	DHC074HWRMA005D	15.5	78,900	97,200	81%	47 x 53 x 88	33 x 17.5	32 x 17.5	990	21	25
7.5	DHC092HWRMA005D	15.5	96,200	121,500/85,050	81%	47 x 53 x 88	33 x 17.5	32 x 17.5	1004	22	25
8.5	DHC102HWRMA005D	15.5	105,900	121,500/85,050	81%	47 x 53 x 88	33 x 17.5	32 x 17.5	1016	23	25
10	DHC120HWRMA005D	15.5	123,600	162,000/113,400	81%	51 x 63 x 100	33 x 17.5	32 x 17.5	1499	23	30
DHC - 208-230/3/60 - Three Phase - High Heat											
3	DHC036H3RHB005D	15.7 / 8.3	40,500	81,000 / 56,700	81%	41 x 44 x 69	18 x 15.5	24 x 14	658	23	30
4	DHC048H3RHA005D	16.5 / 8.8	48,750	105,300 / 73,710	81%	41 x 53 x 88	33 x 17.5	32 x 17.5	845	29	40
5	DHC060H3RHA005D	16.2 / 8.9	61,000	121,500 / 85,050	81%	41 x 53 x 88	33 x 17.5	32 x 17.5	849	32	45
6	DHC074H3RHA005D	15.5	78,900	121,500/85,050	81%	47 x 53 x 88	33 x 17.5	32 x 17.5	990	42	50
7.5	DHC092H3RHA005D	15.5	96,200	162,000/113,400	81%	47 x 53 x 88	33 x 17.5	32 x 17.5	1004	43	50
8.5	DHC102H3RHA005D	15.5	105,900	162,000/113,400	81%	47 x 53 x 88	33 x 17.5	32 x 17.5	1016	46	60
10	DHC120H3RHA005D	15.5	123,600	202,500/141,750	81%	51 x 63 x 100	33 x 17.5	32 x 17.5	1499	49	60
DHC - 460/3/60 - Three Phase - High Heat											
3	DHC036H4RHB005D	15.6 / 8.3	40,500	81,000 / 56,700	81%	41 x 44 x 69	18 x 15.5	24 x 14	658	13	15
4	DHC048H4RHA005D	16.5 / 8.8	48,750	105,300 / 73,710	81%	41 x 53 x 88	33 x 17.5	32 x 17.5	845	14	15
5	DHC060H4RHA005D	16.0 / 8.9	61,000	121,500 / 85,050	81%	41 x 53 x 88	33 x 17.5	32 x 17.5	849	15	20
6	DHC074H4RHA005D	15.5	78,900	121,500/85,050	81%	47 x 53 x 88	33 x 17.5	32 x 17.5	990	19	25
7.5	DHC092H4RHA005D	15.5	96,200	162,000/113,400	81%	47 x 53 x 88	33 x 17.5	32 x 17.5	1004	20	25
8.5	DHC102H4RHA005D	15.5	105,900	162,000/113,400	81%	47 x 53 x 88	33 x 17.5	32 x 17.5	1016	22	25
10	DHC120H4RHA005D	15.5	123,600	202,500/141,750	81%	51 x 63 x 100	33 x 17.5	32 x 17.5	1499	24	30
DHC - 575/3/60 - Three Phase - High Heat											
3	DHC036HWRHB005D	15.6 / 8.3	40,500	81,000 / 56,700	81%	41 x 44 x 69	18 x 15.5	24 x 14	658	9	15
4	DHC048HWRHA005D	16.5 / 8.8	48,750	105,300 / 73,710	81%	41 x 53 x 88	33 x 17.5	32 x 17.5	845	10	15
5	DHC060HWRHA005D	16.0 / 8.9	61,000	121,500 / 85,050	81%	41 x 53 x 88	33 x 17.5	32 x 17.5	849	12	15
6	DHC074HWRHA005D	15.5	78,900	121,500/85,050	81%	47 x 53 x 88	33 x 17.5	32 x 17.5	990	21	25
7.5	DHC092HWRHA005D	15.5	96,200	162,000/113,400	81%	47 x 53 x 88	33 x 17.5	32 x 17.5	1004	22	25
8.5	DHC102HWRHA005D	15.5	105,900	162,000/113,400	81%	47 x 53 x 88	33 x 17.5	32 x 17.5	1016	23	25
10	DHC120HWRHA005D	15.5	123,600	202,500/141,750	81%	51 x 63 x 100	33 x 17.5	32 x 17.5	1499	23	30

* Information subject to change. Please confirm with current Product Data/Service Facts for current factory production.

① HCAR breaker per NEC.

② SEER applies, 3-5 tons; HSPF applies 6-10 tons.

For complete equipment / combination selections, installation instructions and warranty information, please refer to Product Data/Ratings and/or Installers Guides and Limited Warranty Handbooks.



It's Hard To Stop A Trane.®

Precedent™ Packaged Heat Pump Convertible 3-10 Tons, R-410A

Table LPH-4-A – Base Unit – Standard Efficiency – ReliaTel™ Microprocessor Controls

Tons	Unit Ordering No.	Performance ^② SEER/HSPF	Cooling Capacity (Btuh)	Cabinet Dimensions (in.) H x D x W	Downflow Supply	Downflow Return	Shipping Weight (lbs.)	MCA*	Max ^① Fuse*
WSC - 208-230/3/60 - Three Phase - No Electric Heat									
3	WSC036H3R0A005D	14.0	39,500	41 x 44 x 69	18 x 15.5	24 x 14	612	26	40
4	WSC048H3R0A005D	14.0	50,000	41 x 44 x 69	18 x 15.5	24 x 14	645	27	40
5	WSC060H3R0A005D	14.0	61,000	41 x 53 x 88	33 x 17.5	32 x 17.5	777	31	45
7½	WSC092H3R0B005D	14.1	95,300	47 x 53 x 88	33 x 17.5	32 x 17.5	894	40	60
8½	WSC102H3R0B005D	14.1	103,200	47 x 53 x 88	33 x 17.5	32 x 17.5	927	45	70
10	WSC120H3R0B005D	14.1	118,100	47 x 53 x 88	33 x 17.5	32 x 17.5	948	54	80
WSC - 460/3/60 - Three Phase - No Electric Heat									
3	WSC036H4R0A005D	14.0	39,500	41 x 44 x 69	18 x 15.5	24 x 14	612	11	15
4	WSC048H4R0A005D	14.0	50,000	41 x 44 x 69	18 x 15.5	24 x 14	645	12	15
5	WSC060H4R0A005D	14.0	61,000	41 x 53 x 88	33 x 17.5	32 x 17.5	777	15	20
7½	WSC092H4R0B005D	14.1	95,300	47 x 53 x 88	33 x 17.5	32 x 17.5	894	18	25
8½	WSC102H4R0B005D	14.1	103,200	47 x 53 x 88	33 x 17.5	32 x 17.5	927	20	30
10	WSC120H4R0B005D	14.1	118,100	47 x 53 x 88	33 x 17.5	32 x 17.5	948	24	35
WSC - 575/3/60 - Three Phase - No Electric Heat									
3	WSC036HWR0A005D	14.0	39,500	41 x 44 x 69	18 x 15.5	24 x 14	612	11	15
4	WSC048HWR0A005D	14.0	50,000	41 x 44 x 69	18 x 15.5	24 x 14	645	12	15
5	WSC060HWR0A005D	14.0	61,000	41 x 53 x 88	33 x 17.5	32 x 17.5	777	13	15
7½	WSC092HWR0B005D	14.1	95,300	47 x 53 x 88	33 x 17.5	32 x 17.5	894	14	20
8½	WSC102HWR0B005D	14.1	103,200	47 x 53 x 88	33 x 17.5	32 x 17.5	927	16	20
10	WSC120HWR0B005D	14.1	118,100	47 x 53 x 88	33 x 17.5	32 x 17.5	948	23	30

* Information subject to change. Please confirm with current Product Data/Service Facts for current factory production.

① HCAR breaker per NEC.

② SEER applies, 3-5 tons; HSPF applies 6-10 tons.



It's Hard To Stop A Trane.®

Precedent™ Packaged Heat Pump Convertible 3-10 Tons (Model Digit Numbers)

Digit	Description	Order Number	Digit	Description	Order Number
1-8	Main Assembly (see previous page)		21	Communications Options	
9	Unit Controls			No Communications Interface	0
	ReliaTel™ Micro-processor.....	R		Trane Communications Interface	1
10	(Heater Table see next page)			LonTalk® Communications Interface.....	2
11	Design Sequence	*		BACnet™ Communications Interface.....	6
12-13	Service Sequence		22	Refrigeration System Option	
	First Sequence (Factory Assigned).....	*.*		Standard Refrigeration System®	0
14	Fresh Air Selection		23	Refrigeration Controls	
	No Fresh Air	0		No Refrigeration Control®.....	0
	Manual Outside Air Damper 0-50%®	A		Frostat	1
	Motorized Outside Air Damper 0-50%®	B	24	Smoke Detector	
	Economizer, Dry Bulb 0-100% without Barometric Relief®.....	C		No Smoke Detector	0
	Economizer, Dry Bulb 0-100% with Barometric Relief®	D		Return Air Smoke Detector®.....	A
	Economizer, Reference Enthalpy 0-100% without Barometric Relief®	E		Supply Air Smoke Detector	B
	Economizer, Reference Enthalpy 0-100% with Barometric Relief®	F		Supply and Return Air Smoke Detectors®	C
	Economizer, Comparative Enthalpy 0-100% without Barometric Relief®	G		Plenum Smoke Detector	D
	Economizer, Comparative Enthalpy 0-100% with Barometric Relief®	H	25	System Monitoring Controls	
	Low Leak Economizer, Dry Bulb with Barometric Relief.....	K		No Monitoring Control	0
	Low Leak Economizer, Comparative Enthalpy with Barometric Relief	M		Clogged Filter Switch	1
	Low Leak Economizer, Reference Enthalpy with Barometric Relief	P		Fan Failure Switch	2
15	Supply Fan/Drive Type/Motor			Discharge Air Sensing Tube	3
	Standard Drive®	0		Clogged Filter Switch and Fan Fail Switch.....	4
	Oversized Motor	1		Clogged Filter Switch and Discharge Air Sensing Tube.....	5
	Optional Belt Drive Motor.....	2		Fan Fail Switch and Discharge Air Sensing Tube.....	6
	Single Zone Variable Air Volume (SZVAV)	6		Clogged Filter and Fan Fail Switches and Discharge Air Sensing Tube	7
	Multi-Speed Indoor Fan®	7		Condensate Drain Pan Overflow Switch.....	A
16	Hinged Service Access/Filters			Clogged Filter Switch and Condensate Drain Pan Overflow Switch.....	B
	Standard Panels/Standard Filters	0		Fan Failure Switch and Condensate Drain Pan Overflow Switch.....	C
	Hinged Access Panels/Standard Filters	A		Discharge Air Sensing and Condensate Drain Pan Overflow Switch.....	D
	Standard Panels/2" MERV 8 Filters	B		Clogged Filter Switch, Fan Failure Switch and Condensate Drain Pan Overflow Switch.....	E
	Hinged Access Panels/2" MERV 8 Filters.....	C		Clogged Filter Switch, Discharge Air Sensing Tube and Condensate Drain Pan Overflow Switch.....	F
	Standard Panels/2" MERV 13 Filters	D		Fan Failure Switch, Discharge Air Sensing Tube and Condensate Drain Pan Overflow Switch.....	G
	Hinged Access Panels/2" MERV 13 Filters.....	E		Clogged Filter Switch, Fan Failure Switch, Discharge Air Sensing and Condensate Drain Pan Overflow Switch	H
17	Condenser Coil Protection		26	System Monitoring Controls	
	Standard Coil	0		No Monitoring Controls	0
	Standard Coil with Hail Guard.....	1		Demand Control Ventilation (CO2)®	A
	Black Epoxy Pre-Coated Condenser Coil.....	2	27	Unit Hardware Enhancements	
	Black Epoxy Pre-Coated Condenser Coil with Hail Guard	3		No Enhancements	0
18	Through the Base Provisions			Stainless Steel Drain Pan	1
	No Through the Base Provisions.....	0	31	Advanced Unit Controls	
	Through the Base Electric®	A		Standard Unit Controls.....	0
19	Disconnect/Circuit Breaker (three-phase only)			Human Interface	1
	No Disconnect/No Circuit Breaker.....	0			
	Unit Mounted Non-Fused Disconnect®.....	1			
	Unit Mounted Circuit Breaker®.....	2			
20	Convenience Outlet				
	No Convenience Outlet	0			
	Unpowered Convenience Outlet	A			
	Powered Convenience Outlet (three-phase only)®	B			

- ① Available on 3-5 ton models.
- ② Manual outside air damper will ship factory supplied within the unit, but must be field installed.
- ③ High pressure control is standard on all units.
- ④ Multispeed direct drive standard on single-phase products. Belt drive standard on three-phase 3-7½ ton. Variable speed direct drive standard on 10 ton.
- ⑤ Economizer with Barometric Relief is for downflow configured units only. Order Economizer without Barometric Relief for horizontal configuration. Barometric Relief for horizontal configured units must be ordered as field installed accessory.
- ⑥ Through the base electric required when ordering disconnect/circuit breaker options.
- ⑦ Requires use of Disconnect or Circuit Breaker.

- ⑧ Standard metering devices are TXVs.
- ⑨ The return air smoke detector may not fit up or work properly on the Precedent units when used in conjunction with 3rd party accessories such as bolt on heat wheels, economizers and power exhaust. Do not order the return air smoke detectors when using this type of accessory.
- ⑩ Requires hinged access panels.
- ⑪ Crankcase heaters are only available as option on WSC036E, WSC048E1, & WSC060E1. CCH are standard on all other units.
- ⑫ Motorized outside air damper is not available on Multi-Speed or SZVAV (Single Zone Variable Air Volume) products.
- ⑬ Frostat standard on Multi-speed and SZVAV (Single Zone Variable Air Volume) products.
- ⑭ Multi-speed indoor fan only available on 10 ton products.
- ⑮ Demand Control Ventilation Option includes wiring only. The CO2 sensor is a field-installed only option.

For complete equipment / combination selections, installation instructions and warranty information, please refer to Product Data/Ratings and/or Installers Guides and Limited Warranty Handbooks.

LPH-5

Effective 1/1/23
22-8301-36



It's Hard To Stop A Trane.®

Precedent™ Packaged Heat Pump Convertible 3-10 Tons (Model Digit Numbers)

Heaters (Digit 10)

kW Rating	Digit	Nominal BTUH	No. Stages	Used With
208/240/3/60				
4.5/6.0	(2)	13,400/20,500	1	WSC036-060H3, WHC036-060H3
9.0/12.0	(E)	30,800/59,400	2	WSC036-060H3, WHC036-060H3
13.1/17.4	(G)	44,600/59,400	2	WSC036-060H3, WHC036-060H3
17.3/23.0	(J)	58,900/78,500	2	WSC060H3, WHC060H3
6.75/9.0	(C)	23,000/30,700	1	WSC092-102H3, WHC074-102H3
13.5/18.0	(G)	46,100/61,400	1	WSC092-102H3, WHC074-102H3
20.3/27.0	(K)	69,000/92,100	2	WSC092-102H3, WHC074-102H3
27.0/36.0	(N)	92,200/122,900	2	WSC092-102H3, WHC074-102H3
40.5/54.0	(P)	138,200/184,300	2	WSC120H3, WHC120H3
460/3/60				
6.0	(B)	20,500	1	WSC036-060H4, WHC036-060H4
12.0	(E)	41,000	2	WSC036-060H4, WHC036-060H4
17.4	(G)	59,400	2	WSC036-060H4, WHC036-060H4
23.0	(J)	78,500	2	WSC060H4, WHC060H4
9.0	(C)	30,700	1	WSC092-102H4, WHC074-102H4
18.0	(G)	61,400	1	WSC092-102H4, WHC074-102H4
27.0	(K)	92,100	2	WSC092-102H4, WHC074-102H4
36.0	(N)	122,900	2	WSC092-102H4, WHC074-102H4
54.0	(P)	184,300	2	WSC120H4, WHC120H4
575/3/60				
6.0	(B)	20,500	1	WSC036-060HW, WHC036-060HW
12.0	(E)	41,000	2	WSC036-060HW, WHC036-060HW
17.4	(G)	59,400	2	WSC036-060HW, WHC036-060HW
23.0	(J)	78,500	2	WSC060HW, WHC060HW
9.0	(C)	30,700	1	WSC092-102HW, WHC074-102HW
18.0	(G)	61,400	1	WSC092-102HW, WHC074-102HW
27.0	(K)	92,100	2	WSC092-102HW, WHC074-102HW
36.0	(N)	122,900	2	WSC092-102HW, WHC074-102HW
54.0	(P)	184,300	2	WSC120HW, WHC120HW

Digit 15 Selection Details

Digit 15 = 0

Standard Efficiency

- 3 Phase (3 to 5 Ton) = Multispeed Direct Drive Motor
- 3 Phase (6 to 8.5 Ton) = Belt Drive
- 3 Phase (10 Ton) = Ultra High Efficiency Direct Drive Plenum Fan

High Efficiency

- 1 Phase = High Efficiency Multispeed Direct Drive Motor
- 3 Phase (3 to 5 ton) = High Efficiency Multispeed Direct Drive Motor
- 3 Phase (3 to 5 ton w/Dehumidification) = Belt Drive Motor
- 3 Phase [6 (074) to 10 ton] = Ultra High Efficiency Direct Drive Plenum Fan

Digit 15 = 2

Standard Efficiency

- 3 Phase = Not Available

High Efficiency

- 1 Phase = Not Available

For complete equipment / combination selections, installation instructions and warranty information, please refer to Product Data/Ratings and/or Installers Guides and Limited Warranty Handbooks.



It's Hard To Stop A Trane.®

Precedent™ Packaged Heat Pump Convertible 3-10 Tons Electric Heaters

Table LPH-7-A — Accessory Electric Heaters – Unit with Heater is single circuit / single point power entry (3-5 Ton units)

Model Number	Power Supply	kW Rating	Nominal BTUH	No. Stages	Used With
BAYHTRE306*	208-230/3/60	4.5/6.0	13,400/20,500	1	WHC036H3, WSC036-048H3
BAYHTRE312*	208-230/3/60	9.0/12.0	30,800/41,000	2	WHC036H3, WSC036-048H3
BAYHTRE406*	460/3/60	6	20500	1	WHC036H4, WSC036-048H4
BAYHTRE412*	460/3/60	12	41000	2	WHC036H4, WSC036-048H4
BAYHTREW06*	575/3/60	6	20500	1	WHC036HW, WSC036-048HW
BAYHTREW12*	575/3/60	12	41000	2	WHC036HW, WSC036-048HW
BAYHTRX306*	208-230/3/60	4.5/6.0	13,400/20,500	1	WHC048-060H3, WSC060H3
BAYHTRX312*	208-230/3/60	9.0/12.0	30,800/41,000	2	WHC048-060H3, WSC060H3
BAYHTRX406*	460/3/60	6	20500	1	WHC048-060H3, WSC060H4
BAYHTRX412*	460/3/60	12	41000	2	WHC048-060H3, WSC060H4
BAYHTRXW06*	575/3/60	6	20500	1	WHC048-060HW, WSC060HW
BAYHTRXW12*	575/3/60	12	41000	2	WHC048-060HW, WSC060HW
BAYHTRY317*	208-230/1/60	13.1/17.4	44,600/59,400	2	WHC036H3, WSC036-048H3
BAYHTRY318*	208-230/1/60	13.1/17.4	44,600/59,400	2	WHC048-060H3, WSC060H3
BAYHTRY323*	208-230/1/60	17.3/23.0	59,000/78,500	2	WHC060H3, WSC060H3
BAYHTRY417*	460/3/60	17.4	59400	2	WHC036H4, WSC036-048H4
BAYHTRY418*	460/3/60	17.4	59400	2	WHC048-060H4, WSC060H4
BAYHTRY423*	460/3/60	23	78500	2	WHC060H4, WSC060H4
BAYHTRYW17*	575/3/60	17.4	59400	2	WHC036HW, WSC036-048HW
BAYHTRYW18*	575/3/60	17.4	59400	2	WHC048-060HW, WSC060HW
BAYHTRYW23*	575/3/60	23	78500	2	WHC060HW, WSC060HW

(* Parts designator subject to change

For complete equipment / combination selections, installation instructions and warranty information, please refer to Product Data/Ratings and/or Installers Guides and Limited Warranty Handbooks.

LPH-7

Effective 1/1/23
22-8301-36



It's Hard To Stop A Trane.®

Precedent™ Packaged Heat Pump Convertible 3-10 Tons Electric Heaters and Zone Sensors

Table LPH-8-A – Accessory Electric Heaters – Unit with Heater is single circuit / single point power entry (6 - 8 1/2 Ton units)

Model Number	Power Supply	kW Rating	Nominal BTUH	No. Stages	Used With
BAYHTRU309*	208-230/3/60	6.8/9.0	23,000/30,700	1	WSC092H3, WSC102H3
BAYHTRU318*	208-230/3/60	13.5/18.0	46,100/61,400	1	WSC092H3, WSC102H3, WSC120H3
BAYHTRU327*	208-230/3/60	20.3/27.0	69,000/92,100	2	WWSC092H3, WSC102H3, WSC120H3
BAYHTRU336*	208-230/3/60	27.0/36.0	92,100/122,900	2	WSC092H3, WSC102H3, WSC120H3
BAYHTRU409*	460/3/60	9	30700	1	WSC092H4, WSC102H4
BAYHTRU418*	460/3/60	18	61400	1	WSC092H4, WSC102H4, WSC120H4
BAYHTRU427*	460/3/60	27	92100	2	WSC092H4, WSC102H4, WSC120H4
BAYHTRU436*	460/3/60	36	122900	2	WSC092H4, WSC102H4, WSC120H4
BAYHTRUW18*	575/3/60	18	61400	1	WSC092HW, WSC102HW, WSC120HW
BAYHTRUW27*	575/3/60	27	92100	2	WSC092HW, WSC102HW, WSC120HW
BAYHTRUW36*	575/3/60	36	122900	2	WSC092HW, WSC102HW, WSC120HW

Table LPH-8-B – Accessory Electric Heaters - Unit with Heater is single circuit / single point power entry (Select 7½ - 8½ Ton, All 10 Ton units)

Model Number	Power Supply	kW Rating	Nominal BTUH	No. Stages	Used With
BAYHTRB318*	208-230/3/60	13.5/18.0	46,100/61,400	1	WHC120H3, WSC120H3
BAYHTRB327*	208-230/3/60	20.3/27.0	69,000/92,100	2	WHC120H3, WSC120H3
BAYHTRB336*	208-230/3/60	27.0/36.0	92,100/122,900	2	WHC120H3, WSC120H3
BAYHTRB354*	208-230/3/60	40.6/54.0	138,000/184,300	2	WHC120H3
BAYHTRB418*	460/3/60	18	61400	1	WHC120H4, WSC120H4
BAYHTRB427*	460/3/60	27	92100	2	WHC120H4, WSC120H4
BAYHTRB436*	460/3/60	36	122900	2	WHC120H4, WSC120H4
BAYHTRB454*	460/3/60	54	184300	2	WHC120H4
BAYHTRBW18*	575/3/60	18	61400	1	WHC120HW, WSC120HW
BAYHTRBW36*	575/3/60	36	122900	2	WHC120HW, WSC120HW
BAYHTRBW54*	575/3/60	54	184300	2	WHC120HW, WSC120HW
BAYHTRA309*	208-230/3/60	6.8/9.0	23,000/30,700	1	WSC092H3 [Ⓞ] , WSC102H3 [Ⓞ] , WHC074-102H3
BAYHTRA318*	208-230/3/60	13.5/18.0	46,100/61,400	1	WSC092H3 [Ⓞ] , WSC102H3 [Ⓞ] , WHC074-102H3, WSC120H3
BAYHTRA327*	208-230/3/60	20.3/27.0	69,000/92,100	2	WSC092H3 [Ⓞ] , WSC102H3 [Ⓞ] , WHC074-102H3, WSC120H3
BAYHTRA336*	208-230/3/60	27.0/36.0	92,100/122,900	2	WSC092H3 [Ⓞ] , WSC102H3 [Ⓞ] , WHC074-102H3, WSC120H3
BAYHTRA354*	208-230/3/60	40.6/54.0	138,000/184,300	2	WSC120H3
BAYHTRA409*	460/3/60	9	30700	1	WSC092H4 [Ⓞ] , WSC102H4 [Ⓞ] , WHC074-102H4
BAYHTRA418*	460/3/60	18	61400	1	WSC092H4 [Ⓞ] , WSC102H4 [Ⓞ] , WHC074-102H4, WSC120H4
BAYHTRA427*	460/3/60	27	92100	2	WSC092H4 [Ⓞ] , WSC102H4 [Ⓞ] , WHC074-102H4, WSC120H4
BAYHTRA436*	460/3/60	36	122900	2	WSC092H4 [Ⓞ] , WSC102H4 [Ⓞ] , WHC074-102H4, WSC120H4
BAYHTRA454*	460/3/60	54	184300	2	WSC120H4
BAYHTRAW18*	575/3/60	18	61400	1	WSC092HW [Ⓞ] , WSC102HW [Ⓞ] , WHC074-102HW, WSC120HW
BAYHTRW27*	575/3/60	27	92100	2	WSC092HW [Ⓞ] , WSC102HW [Ⓞ] , WSC120HW, WHC074-102HW, WSC120HW
BAYHTRAW36*	575/3/60	36	122900	2	WSC092HW [Ⓞ] , WSC102HW [Ⓞ] , WSC120HW, WHC074-102HW, WSC120HW
BAYHTRAW54*	575/3/60	54	184300	2	WSC120H4W

Ⓞ Used when Single Zone VAV (SZVAV) or Multi Speed options are selected (digit 15=6 or 7 in model number)

* Parts designator subject to change

Light Commercial
Packaged Heat Pumps

For complete equipment / combination selections, installation instructions and warranty information, please refer to Product Data/Ratings and/or Installers Guides and Limited Warranty Handbooks.



It's Hard To Stop A Trane.®

Precedent™ Packaged Heat Pump Convertible 3-10 Tons Accessories

Table LPH-9-A — Accessories

Model Number	Description	Used With
BAYABRD001C4.....	ReliaTel™ Options Module.....	All Precedents, See Note②
BAYBARM010*②.....	Barometric Relief.....	WSC036-048H, WHC036H, DHC036H
BAYBARM011*②.....	Barometric Relief.....	WSC060-120H, WHC048-120H, DHC048-120H
BAYCO2K001*.....	CO2 Sensor Kit, Wall Mounted.....	All Precedents
BAYCO2K003*.....	CO2 Sensor Kit, Duct Mounted.....	All Precedents
BAYCURB042 / FIACURB401*③.....	Roof Curb.....	WSC036-048H, WHC036H, DHC036H
BAYCURB043 / FIACURB402*③.....	Roof Curb.....	WSC060-120H, WHC048-102H, DHC048-102H
BAYCURB044 / FIACURB403*③.....	Roof Curb.....	WHC120H, DHC120H
BAYDFPS003*④.....	Clogged Filter Switch (w/Standard & MERV 8 Filter).....	All Precedents
BAYDFPS014*④.....	Clogged Filter Switch (MERV 13 Filter).....	All Precedents
BAYDFPS004*④.....	Fan Failure Switch.....	All Precedents
BAYDMPR053*⑤.....	0-50% Manual Outside Air Damper.....	WSC036-048H, WHC036H, DHC036H
BAYDMPR056*⑤.....	0-50% Manual Outside Air Damper.....	WSC060-120H, WHC048-120H, DHC048-120H
BAYDMPR051*.....	0-50% Motorized Outside Air Damper.....	WSC036-048H, WHC036H, DHC036H
BAYDMPR054*.....	0-50% Motorized Outside Air Damper.....	WSC060-120H, WHC048-120H, DHC048-120H
BAYECON085*.....	0-100% Economizer without Barometric Relief.....	WSC036-048H, WHC036H, DHC036H
BAYECON087*.....	0-100% Economizer without Barometric Relief.....	WSC060-120H, WHC048-120H, DHC048-120H
BAYECON704*.....	Downflow Low Leak Economizer.....	WSC060-120H, WHC048-120H, DHC048-120H
BAYECON705*.....	Downflow Low Leak Economizer.....	WSC036-048H, WHC036H, DHC036H
BAYENTH005*①.....	Reference Enthalpy Kit.....	BAYECON085A, 087A
BAYENTH006*①.....	Comparative Enthalpy Kit.....	BAYECON085A, 087A
BAYFRST003*⑥.....	High Temperature Stat.....	All Precedents
BAYGARD437*.....	Condenser Coil Hail Guard.....	WSC036-048H, WHC036H, DHC036H
BAYGARD240*.....	Condenser Coil Hail Guard.....	WSC060-072H, WHC048-060, DHC048-060H
BAYGARD241*.....	Condenser Coil Hail Guard.....	WSC090-120H, WHC074-102H, DHC074-102H
BAYGARD270*.....	Condenser Coil Hail Guard.....	DHC120H, WHC120H
BAYHAKT011*.....	High Altitude Gas Kit.....	DHC036-060H3/4/W
BAYHATK010*.....	High Altitude Gas Kit.....	DHC074-120H3/4/W

- ① Kits contain all necessary parts to achieve desired level of enthalpy control.
 - ② Barometric Relief accessory installs in ductwork for horizontal configuration. For downflow configuration, installs on the unit's horizontal return duct. Panel see Installer's Guide for complete instructions.
 - ③ Lynn Haven manufacturing has a no return policy for this roof curb.
 - ④ BAYABRD001* is required when ordering field installed accessories Clogged Filter Switch (BAYDFPS003*), Fan Fail Switch (BAYDFPS004*), Discharge Air Sensing Kit (BAYTUBE005* or BAYTUBE007*) or Evaporator Defrost Control (Frostat) (BAYLOAM020*) Ventilation Override Kit (BAYVNOR001*) unless the following options are factory installed: Frostat, Smoke Detector, Clogged Filter Switch, Fan Failure Switch, Discharge Air Sensing Kit. These factory installed options include the ReliaTel™ Options Module.
 - ⑤ Cannot be used in conjunction with factory installed smoke detector.
 - ⑥ The manual outside air damper will ship factory supplied within the unit, but must be field installed.
- * Parts designator subject to change

For complete equipment / combination selections, installation instructions and warranty information, please refer to Product Data/Ratings and/or Installers Guides and Limited Warranty Handbooks.



It's Hard To Stop A Trane.®

Precedent™ Packaged Heat Pump Convertible 3-10 Tons Accessories

Table LPH-10-A – Accessories

Model Number	Description	Used With
BAYHSMT400*	3 HP Belt Drive Oversized Motor.....	WSC092H3/4, WSC102H3/4
BAYHSMT401*	3 HP Belt Drive Oversized Motor.....	WSC092HW, WSC102HW
BAYICSI003*Ⓞ	Trane Communications Interface (TCI).....	All Precedents
BAYLOAM020*Ⓞ	Evaporator Defrost Control (Frostat)	All Precedents
BAYLPKT050*	Single Stage Gas LP Kit	DHC074H**(L,X,M,Y), DHC(092/102)H**(L,X)
BAYHATK010*	Dual Stage Gas LP Kit High Altitude Gas Kit	DHC074H(3,4,W)*(H,Z), DHC(092/102) H(3,4,W)*(M,Y,H,Z), DHC120H(3,4,W)*(L,X,M,Y,H,Z)
BAYLTICI002*Ⓞ	LonTalk® Communications Interface (LCI).....	All Precedents
BAYPWRX070*	Power Exhaust (208-230/3).....	WSC036-048H3, WHC036H3, DHC036H3
BAYPWRX071*	Power Exhaust (460/3).....	WSC036-048H4, WHC036H4, DHC036H4
BAYPWRX072*	Power Exhaust (575/3).....	WSC036-048HW, WHC036HW, DHC036HW
BAYPWRX026*Ⓞ	Power Exhaust (208-230/3).....	WSC060-120H3, WHC048-120H3, DHC048-120H3
BAYPWRX027*Ⓞ	Power Exhaust (460/3).....	WSC060-120H4, WHC048-120H4, DHC048-120H4
BAYPWRX028*Ⓞ	Power Exhaust (575/3).....	WSC060-120H4, WHC048-120H4, DHC048-120H4
BAYQACB009*ⓄⓄ	Quick Adapt Roof Curb	WSC036-048H, WHC036H, DHC036H
BAYQACB010*ⓄⓄ	Quick Adapt Roof Curb	WSC036-048H, WHC036H, DHC036H
BAYQACB011*ⓄⓄ	Quick Adapt Roof Curb	WSC060-120H, WHC048-102H, DHC048-120H
BAYQACB012*ⓄⓄ	Quick Adapt Roof Curb	WSC060-120H, WHC048-102H, DHC048-120H
BAYQACB013 / FIAQACB027*ⓄⓄ	Quick Adapt Roof Curb	WSC060-120H, WHC048-102H, DHC048-120H
BAYQACB111*ⓄⓄ	Quick Adapt Roof Curb	WHC120H, DHC120H
BAYQACB112*ⓄⓄ	Quick Adapt Roof Curb	WHC120H, DHC120H
BAYQACB113*ⓄⓄ	Quick Adapt Roof Curb	WHC120H, DHC120H
BAYQACB114 / FIAQACB044*ⓄⓄ	Quick Adapt Roof Curb	WSC060-120H, WHC048-102H, DHC048-120H
BAYQACB115*ⓄⓄ	Quick Adapt Roof Curb	WSC060-120H, WHC048-102H, DHC048-120H

- Ⓞ Used for true discharge air sensing in both heating and cooling. Required for supply air tempering.
 - Ⓞ Lynn Haven manufacturing has a no return policy for this roof curb.
 - Ⓞ BAYQACB009* adapts Voyager BAYCURB021* roof curb to accept Precedent 3-5 ton unit. BAYQACB010* adapts Voyager BAYCURB022* roof curb to accept Precedent 3-5 ton unit. BAYQACB111* adapts Voyager BAYCURB022 roof curb to accept WSC120E. BAYQACB112A adapts Voyager BAYCURB025 roof curb to accept WSC120E. BAYQACB113* adapts Voyager BAYCURB026 roof curb to accept WSC120E.
 - Ⓞ BAYABRD001* is required when ordering field installed accessories Clogged Filter Switch (BAYDFPS003*), Fan Fail Switch (BAYDFPS004*), Discharge Air Sensing Kit (BAYTUBE005* or BAYTUBE007*) or Evaporator Defrost Control (Frostat) (BAYLOAM020*) Ventilation Override Kit (BAYVNOR001*) unless the following options are factory installed: Frostat, Smoke Detector, Clogged Filter Switch, Fan Failure Switch, Discharge Air Sensing Kit. These factory installed options include the ReliaTel™ Options Module.
 - Ⓞ Interface allows unit to communicate with Tracer 100, Tracker, VariTrac II, and is the preferred method of communication to Tracer Summit.
 - Ⓞ Power Exhaust cannot be used with Barometric Relief. Order Economizer without Barometric Relief.
 - Ⓞ Interface allows unit to communicate as a Trane LonTalk® device or directly with generic LonTalk® Network BAS Controls.
 - Ⓞ BAYQACB012* adapts Voyager BAYCURB025 roof curb to accept Precedent 6-10 ton unit. BAYQACB011* adapts Voyager BAYCURB022* roof curb to accept Precedent 6-10 ton unit. BAYQACB adapts Voyager BAYCURB026 roof curb to accept WSC060-090E.
 - Ⓞ Field installed accessory. Requires an economizer.
 - Ⓞ If any version of comparative or reference enthalpy is ordered, BAYRTEM001* does not need to be ordered.
 - Ⓞ Order only when unit has factory installed Demand Control Ventilation option.
 - Ⓞ Precedent E cabinet to Precedent D cabinet (BAYCURB044 to BAYCURB043)
 - Ⓞ Precedent B cabinet to Precedent C cabinet (BAYCURB042 to BAYCURB043)
- * Parts designator subject to change

Light Commercial Packaged Heat Pumps

For complete equipment / combination selections, installation instructions and warranty information, please refer to Product Data/Ratings and/or Installers Guides and Limited Warranty Handbooks.



It's Hard To Stop A Trane.®

Precedent™ Packaged Heat Pump with Symbio™ Convertible 12.5-25 Tons

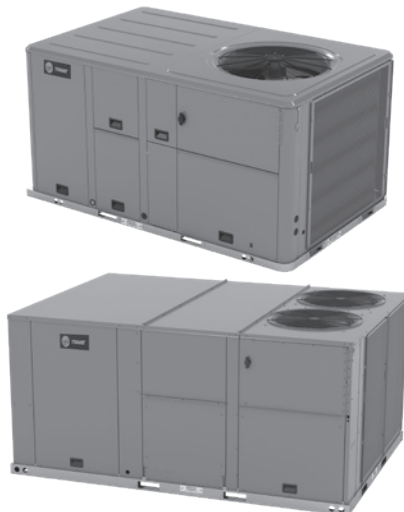

Small compact cabinet
Recessed access handles

Standard Features:

- Symbio 700 controller
- MultiSpeed Indoor
- Manifolded scroll compressors
- 6-17.5 tons = 3 stages of cooling; 20-25 tons = 4 stages of cooling
- Al fin/Cu tube condenser and evaporator coils
- Colored, keyed, and numbered wiring
- Froststat
- Phase monitor
- Coil/Hailguards
- Crankcase heaters on all compressors
- 2" filters
- Backward curved direct drive plenum supply fan
- Liquid line refrigerant drier
- Operating Charge of R-410A
- Composite dual sloped drain pans
- Single point power for electric heat
- Low Ambient cooling to 40°F
- 5 - year Limited Compressor Warranty
- 3 - year Limited Parts Warranty

Added Flexibility

- Standard or high efficiency cooling models available.
- Convertible airflow (ships in downflow application)
- Hybrid/dual fuel option
- 2" filters included
- Fork lift openings on three sides of unit
- Choose options tailored to suit each job — pay only for what is needed
- Units ship with options installed — and within our standard ship cycle time

Factory Installed Options

- Outdoor air dampers (manual or motorized)
- Economizers (Base or Low Leak)
- Dry Bulb, Reference Enthalpy, Comparative Enthalpy, or Differential Dry Bulb economizer control options
- Stainless steel tubular heat exchanger
- Through-the-Base — Electrical
- Convenience Outlet — Powered or unpowered
- Unit Disconnect Switch
- Smoke Detectors — Supply, return, or both
- Condenser Coil Coating
- Hinged Access Service Panels
- Discharge Air Sensor
- Low Ambient cooling to 0°F
- Clogged Filter Switch
- Dehumidification (Modulating Hot Gas Reheat)
- Symbio 700 BACnet® communication interface license
- Symbio 700 LonTalk® communication interface license
- 2" MERV 8 filters or 2" MERV 13 filters
- Single Zone or Multiple Zone VAV Indoor Airflow
- Demand Control Ventilation
- Stainless Steel Drainpan
- Condensate Drainpan Overflow Switch



Precedent™ Packaged Heat Pump with Symbio™ Convertible 12.5 - 25 Tons, High Efficiency R-410A

Table LPH-12-A – Base Unit – High Efficiency – R-410A – Symbio

Tons	Unit Ordering No.	Performance IEER(2-speed)/EER	Net Cooling Capacity (Btuh)	Cabinet Dimensions (in.) H x W x L	Cabinet	Shipping Weight (lbs.)	MCA**	Max Fuse**
WHJ – 208-230/3/60 – Three Phase								
12.5	WHJ150A3S0L0000	17.8/12.3	154,000	50 ⁷ / ₈ x 63 ¹ / ₈ x 99 ⁵ / ₈	C	2225	72	90
15	WHJ180A3S0L0000	17.9/12.0	182,000	59 x 87 x 123	D	2246	78	100
20	WHJ240A3S0L0000	17.2/11.2	246,000	59 x 87 x 123	D	2403	108	150
25	WHJ300A3S0L0000	16.1/10.4	272,000	59 x 87 x 123	D	2405	119	150
WHJ – 460/3/60 – Three Phase								
12.5	WHJ150A4S0L0000	17.8/12.3	154,000	50 ⁷ / ₈ x 63 ¹ / ₈ x 99 ⁵ / ₈	C	2225	37	50
15	WHJ180A4S0L0000	17.9/12.0	182,000	59 x 87 x 123	D	2246	41	50
20	WHJ240A4S0L0000	17.2/11.2	246,000	59 x 87 x 123	D	2403	54	70
25	WHJ300A4S0L0000	16.1/10.4	272,000	59 x 87 x 123	D	2405	59	80
WHJ – 575/3/60 – Three Phase								
12.5	WHJ150AWS0L0000	17.8/12.3	154,000	50 ⁷ / ₈ x 63 ¹ / ₈ x 99 ⁵ / ₈	C	2225	29	40
15	WHJ180AWS0L0000	17.9/12.0	182,000	59 x 87 x 123	D	2246	32	40
20	WHJ240AWS0L0000	17.2/11.2	246,000	59 x 87 x 123	D	2403	47	60
25	WHJ300AWS0L0000	16.1/10.4	272,000	59 x 87 x 123	D	2405	46	60

** Information subject to change. Please confirm with current product catalog Or IOM for current factory production.

Table LPH-12-B – Base Unit – High Efficiency Dual Fuel Unit – R-410A – Symbio

Tons	Unit Ordering No.	Performance IEER(2-speed)/EER	Net Cooling Capacity (Btuh)	Cabinet Dimensions (in.) H x W x L	Cabinet	Shipping Weight (lbs.)	MCA**	Max Fuse**
DHJ – 208-230/3/60 – Three Phase								
12.5	DHJ150A3S0L0000	17.6/12.1	154,000	50 ⁷ / ₈ x 63 ¹ / ₈ x 99 ⁵ / ₈	C	2225	72	90
15	DHJ180A3S0L0000	17.7/11.8	182,000	59 x 87 x 123	D	2246	78	100
20	DHJ240A3S0L0000	17.0/11.0	246,000	59 x 87 x 123	D	2403	108	150
25	DHJ300A3S0L0000	15.9/10.2	272,000	59 x 87 x 123	D	2405	119	150
DHJ – 460/3/60 – Three Phase								
12.5	DHJ150A4S0L0000	17.6/12.1	154,000	50 ⁷ / ₈ x 63 ¹ / ₈ x 99 ⁵ / ₈	C	2225	72	90
15	DHJ180A4S0L0000	17.7/11.8	182,000	59 x 87 x 123	D	2246	78	100
20	DHJ240A4S0L0000	17.0/11.0	246,000	59 x 87 x 123	D	2403	108	150
25	DHJ300A4S0L0000	15.9/10.2	272,000	59 x 87 x 123	D	2405	119	150
DHJ – 575/3/60 – Three Phase								
12.5	DHJ150AWS0L0000	17.6/12.1	154,000	50 ⁷ / ₈ x 63 ¹ / ₈ x 99 ⁵ / ₈	C	2225	72	90
15	DHJ180AWS0L0000	17.7/11.8	182,000	59 x 87 x 123	D	2246	78	100
20	DHJ240AWS0L0000	17.0/11.0	246,000	59 x 87 x 123	D	2403	108	150
25	DHJ300AWS0L0000	15.9/10.2	272,000	59 x 87 x 123	D	2405	119	150

** Information subject to change. Please confirm with current product catalog Or IOM for current factory production.



It's Hard To Stop A Trane.®

Precedent™ Packaged Heat Pump with Symbio™ Convertible 12.5-25 Tons, R-410A

Table LPH-13-A – Base Unit – Standard Efficiency – R-410A – Symbio

Tons	Unit Ordering No.	Performance IEER(2-speed)/EER	Net Cooling Capacity (Btuh)	Cabinet Dimensions (in.) H x W x L	Cabinet	Shipping Weight (lbs.)	MCA**	Max Fuse**
WSJ – 208-230/3/60 – Three Phase								
12.5	WSJ150A3S0L0000	13.5/10.6	154,000	50 ⁷ / ₈ x 63 ¹ / ₈ x 99 ⁵ / ₈	C	2225	72	90
15	WSJ180A3S0L0000	13.5/10.6	182,000	59 x 87 x 123	D	2246	78	100
20	WSJ240A3S0L0000	13.5/9.5	246,000	59 x 87 x 123	D	2403	108	150
25	WSJ300A3S0L0000	12.5/9.5	272,000	59 x 87 x 123	D	2405	119	150
WSJ – 460/3/60 – Three Phase								
12.5	WSJ150A4S0L0000	13.5/10.6	154,000	50 ⁷ / ₈ x 63 ¹ / ₈ x 99 ⁵ / ₈	C	2225	37	50
15	WSJ180A4S0L0000	13.5/10.6	182,000	59 x 87 x 123	D	2246	41	50
20	WSJ240A4S0L0000	13.5/9.5	246,000	59 x 87 x 123	D	2403	54	70
25	WSJ300A4S0L0000	12.5/9.5	272,000	59 x 87 x 123	D	2405	59	80
WSJ – 575/3/60 – Three Phase								
12.5	WSJ150AWS0L0000	13.5/10.6	154,000	50 ⁷ / ₈ x 63 ¹ / ₈ x 99 ⁵ / ₈	C	2225	29	40
15	WSJ180AWS0L0000	13.5/10.6	182,000	59 x 87 x 123	D	2246	32	40
20	WSJ240AWS0L0000	13.5/9.5	246,000	59 x 87 x 123	D	2403	47	60
25	WSJ300AWS0L0000	12.5/9.5	272,000	59 x 87 x 123	D	2405	46	60

** Information subject to change. Please confirm with current product catalog Or IOM for current factory production.

Table LPH-13-B – Base Unit – Standard Efficiency Dual Fuel Unit – R-410A – Symbio

Tons	Unit Ordering No.	Performance IEER(2-speed)/EER	Net Cooling Capacity (Btuh)	Cabinet Dimensions (in.) H x W x L	Cabinet	Shipping Weight (lbs.)	MCA**	Max Fuse**
DSJ – 208-230/3/60 – Three Phase								
12.5	DSJ150A3S0L0000	13.3/10.4	154,000	50 ⁷ / ₈ x 63 ¹ / ₈ x 99 ⁵ / ₈	C	2225	72	90
15	DSJ180A3S0L0000	13.3/10.4	182,000	59 x 87 x 123	D	2246	78	100
20	DSJ240A3S0L0000	13.3/9.3	246,000	59 x 87 x 123	D	2403	108	150
25	DSJ300A3S0L0000	12.3/9.3	272,000	59 x 87 x 123	D	2405	119	150
DSJ – 460/3/60 – Three Phase								
12.5	DSJ150A4S0L0000	13.3/10.4	154,000	50 ⁷ / ₈ x 63 ¹ / ₈ x 99 ⁵ / ₈	C	2225	72	90
15	DSJ180A4S0L0000	13.3/10.4	182,000	59 x 87 x 123	D	2246	78	100
20	DSJ240A4S0L0000	13.3/9.3	246,000	59 x 87 x 123	D	2403	108	150
25	DSJ300A4S0L0000	12.3/9.3	272,000	59 x 87 x 123	D	2405	119	150
DSJ – 575/3/60 – Three Phase								
12.5	DSJ150AWS0L0000	13.3/10.4	154,000	50 ⁷ / ₈ x 63 ¹ / ₈ x 99 ⁵ / ₈	C	2225	72	90
15	DSJ180AWS0L0000	13.3/10.4	182,000	59 x 87 x 123	D	2246	78	100
20	DSJ240AWS0L0000	13.3/9.3	246,000	59 x 87 x 123	D	2403	108	150
25	DSJ300AWS0L0000	12.3/9.3	272,000	59 x 87 x 123	D	2405	119	150

** Information subject to change. Please confirm with current product catalog Or IOM for current factory production.

For complete equipment / combination selections, installation instructions and warranty information, please refer to Product Data/Ratings and/or Installers Guides and Limited Warranty Handbooks.



Precedent™ Packaged Heat Pump with Symbio Convertible 12.5-25 Tons (Model Digit Numbers)

Digit	Description	Order Number	Digit	Description	Order Number
1	Unit Function		16	Hinged Service Access & Filters	
	Packaged Heat Pump.....W			Standard Panels/Standard Filters.....0	
	Duel Fuel Heat Pump.....D			Hinged Access Panels/Standard Filters.....A	
2	Cooling Efficiency			Standard Panels/2" MERV 8 Filters.....B	
	Standard Efficiency.....S			Hinged Access Panels/2" MERV 8 Filters.....C	
	High Efficiency.....H			Standard Panels/2" MERV 13 Filters.....D	
3	Refrigerant			Hinged Access Panels/2" MERV 13 Filters.....E	
	R-410A.....J		17	Condenser Coil Protection	
4,5,6	Nominal Gross Cooling Capacity (MBh)			Standard Coil.....0	
	12.5 Ton.....150		18	Through the Base Provisions	
	15 Ton.....180			No Through-the Base-Provisions.....0	
	20 Ton.....240			Through-the-Base Electric.....A	
	25 Ton.....300		19	Disconnect/Circuit Breaker (3 phase only)	
7	Design Sequence			No Disconnect/Circuit Breaker.....0	
		*		Unit Mounted/Non-Fused Disconnect.....1	
8	Voltage			Unit Mounted Circuit Breaker.....2	
	208-230/60/3.....3		20	Convenience Outlet	
	460/60/3.....4			No Convenience Outlet.....0	
	575/60/3.....W			Unpowered 20A Convenience Outlet.....A	
9	Unit Controls			Powered 15A Convenience Outlet (3 phase only).....B	
	Symbio 700.....S		21	Communications Options	
10	Heat Type			No Communications Interface.....0	
	Base Model (None or Electric).....0			Advanced Controller with BACnet® Communications Interface....1	
11	Heating Capacity			Advanced Controller with LonTalk® Communications Interface....2	
	No Heat.....0			Advanced Controller with Air-Fi® Communications Interface....3	
	18 kW Electric Heat.....G		22	Refrigeration System Option	
	27 kW Electric Heat.....K			Standard Refrigeration System.....0	
	36 kW Electric Heat.....N			Dehumidification Option ①③.....A	
	54 kW Electric Heat.....P		23	Controls Expansion Module	
	72 kW Electric Heat.....R			None.....0	
12-13	Service Sequence			XM-30 Expansion Module.....1	
	Factory Supplied.....*,*			XM-32 Expansion Module.....2	
14	Fresh Air Selection			XM-30 and XM-32 Expansion Module.....3	
	No Fresh Air.....0			XM-30 Expansion Module (Qty 2).....4	
	Manual Outside Air Damper 0-50%.....A			XM-32 Expansion Module (Qty 2).....5	
	Motorized Outside Air Damper 0-50%.....B		24	Smoke Detector	
	Economizer, Dry Bulb 0-100% without Barometric Relief②.....C			No Smoke Detector.....0	
	Economizer, Dry Bulb 0-100% with Barometric Relief②.....D			Return Air Smoke Detector2.....A	
	Economizer, Reference Enthalpy 0-100% without Barometric Relief②.....E			Supply Air Smoke Detector1.....B	
	Economizer, Reference Enthalpy 0-100% with Barometric Relief②.....F			Supply and Return Air Smoke Detectors ①②.....C	
	Economizer, Comparative Enthalpy 0-100% without Barometric Relief②.....G		25	System Monitoring Controls	
	Economizer, Comparative Enthalpy 0-100% with Barometric Relief②.....H			No Monitoring Control.....0	
	Downflow Low Leak Economizer, Dry Bulb with Barometric Relief②.....K			Clogged Filter Switch2.....1	
	Downflow Low Leak Economizer, Reference Enthalpy with Barometric Relief②.....M			Condensate Overflow Switch①.....2	
	Downflow Low Leak Economizer, Comparative Enthalpy with Barometric Relief②.....P			Discharge Air Sensing Tube.....3	
	Downflow Low Leak Economizer, Differential Dry Bulb with Barometric Relief②.....R			Clogged Filter Switch and Condensate Overflow Switch①②....4	
15	Supply Fan/Drive Type/Motor			Clogged Filter Switch and Discharge Air Sensing Tube②.....5	
	Standard Drive.....0			Condensate Overflow Switch and Discharge Air Sensing Tube①.....6	
	Optional Oversized/High Static Motor.....1			Clogged Filter Switch, Condensate Overflow Switch and Discharge Air Sensing Tube①②.....7	
	Single Zone Variable Air Volume (SZVAV) with Standard Motor...2		26	Not Used	
	Single Zone Variable Air Volume (SZVAV) with Oversized/High Static Motor.....3				
	Multiple Zone Variable Air Volume (MZVAV) with Standard Motor...4		27	Hardware Enhancements	
	Multiple Zone Variable Air Volume (MZVAV) with Oversized/High Static Motor.....5			No Enhancements.....0	
				Stainless Steel Drain Pan.....1	
			28	Short Circuit Current Rating	
				Standard (5k) SCCR Marking.....0	
				Tier 2 (=65K) SCCR Marking.....A	
			29	Low Ambient4	
				None.....0	
				Low Ambient Cooling to 0°F.....A	

① Includes Symbio Indoor Module.
 ② Includes Symbio Fresh Air Module.
 ③ Includes Symbio Customer Connection Module.
 ④ Standard Low Ambient Cooling Limit is 40°F.

Light Commercial Packaged Heat Pumps

For complete equipment / combination selections, installation instructions and warranty information, please refer to Product Data/Ratings and/or Installers Guides and Limited Warranty Handbooks.

BUILT TO A HIGHER STANDARD

American Standard
HEATING & AIR CONDITIONING

Precedent™ Packaged Heat Pump with Symbio Convertible 12.5-25 Tons Accessories

Table LPC-15-A – Accessories

Model Number	Description	Used With	
		Cabinets	Used With
FIAEHWD318* ^①	18kW, 208-230V Electric Heater	D	WSJ/WHJ150A3-180A3
FIAEHWD336*	36kW, 208-230V Electric Heater	D	WSJ/WHJ150A3-300A3
FIAEHWD354*	54kW, 208-230V Electric Heater	D	WSJ/WHJ150A3-300A3
FIAEHWD372*	72kW, 208-230V Electric Heater	D	WSJ/WHJ210A3-300A3
FIAEHWD418*	18kW, 460V Electric Heater	D	WSJ/WHJ150A4-180A4
FIAEHWD436*	36kW, 460V Electric Heater	D	WSJ/WHJ150A4-300A4
FIAEHWD454*	54kW, 460V Electric Heater	D	WSJ/WHJ150A4-300A4
FIAEHWD472*	72kW, 460V Electric Heater	D	WSJ/WHJ210A4-300A4
FIAEHWDW18*	18kW, 575V Electric Heater	D	WSJ/WHJ150AW-180AW
FIAEHWDW36*	36kW, 575V Electric Heater	D	WSJ/WHJ150AW-300AW
FIAEHWDW54*	54kW, 575V Electric Heater	D	WSJ/WHJ150AW-300AW
FIAEHWDW72*	72kW, 575V Electric Heater	D	WSJ/WHJ210AW-300AW
FIABARM003*	Barometric Relief	D	WSJ/WHJ150A-300A
FIAC02K001*	CO2 (DCV) Wall Mounted Sensor	ALL	WSJ/WHJ150A-300A
FIAC02K002*	CO2 (DCV) Duct Mounted Sensor	ALL	WSJ/WHJ150A-300A
FIACURB404*	14-inch Full Perimeter Knockdown Curb	D	WSJ/WHJ150A-300A
FIACLFS003* ^②	Clogged Filter Switch	D	WSJ/WHJ150A-300A
FIACLS004*	Clogged Filter Switch (MERV13)	D	WSJ/WHJ150A-300A
FIADAST008*	Discharge Air Sensing Tube Kit T/W Models	D	WSJ/WHJ150A-300A
FIADFDB001*	Differential Dry Bulb Economizer Control	ALL	WSJ/WHJ150A-300A
FIADMPR003*	Manual Damper	D	WSJ/WHJ150A-300A
FIADMPR103*	Motorized Damper	D	WSJ/WHJ150A-300A
FIAECON003*	Dry Bulb Downflow Economizer	D	WSJ/WHJ150A-300A
FIAECON303*	Dry Bulb Horizontal Economizer	D	WSJ/WHJ150A-300A
FIAECON103*	Dry Bulb Downflow Low Leak	D	WSJ/WHJ150A-300A
FIAECON203*	Dry Bulb Horizontal Low Leak	D	WSJ/WHJ150A-300A
FIAENTH001*	Reference Enthalpy Economizer Control	ALL	WSJ/WHJ150A-300A
FIAENTH002*	Comparative Enthalpy Economizer Control	ALL	WSJ/WHJ150A-300A
FIAHTST001*	High Temperature (Fire) Duct Mounted Stat	ALL	WSJ/WHJ150A-300A
FIAHZDC001*	Horizontal Conversion Panel	D	WSJ/WHJ150A-300A
FIALOAM001*	Low Ambient	ALL	WSJ/WHJ150A-300A
FIALTCI001*	LonTalk Communication Interface	ALL	WSJ/WHJ150A-300A
FIAOPTN001*	Indoor Options Module	ALL	WSJ/WHJ150A-300A
FIAOPTN002*	Fresh Air Options Module	ALL	WSJ/WHJ150A-300A
FIAOVFL001*	Condensate Overflow Switch	ALL	WSJ/WHJ150A-300A
FIAPWRX303*	Power Exhaust 230V	D	WSJ/WHJ150A3-300A3
FIAPWRX403*	Power Exhaust 460V	D	WSJ/WHJ150A4-300A4
FIAPWRXW03*	Power Exhaust 575V	D	WSJ/WHJ150AW-300AW
FIASCCM001* ^{③④}	Symbio Customer Connection Module	ALL	WSJ/WHJ150A-300A
FIAXMOD030* ^⑤	Symbio 700 XM30 Expansion Module	ALL	WSJ/WHJ150A-300A
FIAXMOD032*	Symbio 700 XM32 Expansion Module	ALL	WSJ/WHJ150A-300A

- ① Requires Symbio Indoor Options Module.
- ② Requires Symbio Fresh Air Options Module.
- ③ Provides Ventilation Override, External Auto/Stop, Alarm Indicator, Remote Min Position.
- ④ Requires Symbio Advanced Controller (digit 21=1 or 3).
- ⑤ Requires Tracer TU and Utilizes TGP2 Software (programming knowledge required).
- * Parts designator subject to change

For complete equipment / combination selections, installation instructions and warranty information, please refer to Product Data/Ratings and/or Installers Guides and Limited Warranty Handbooks.



It's Hard To Stop A Trane.®



Beveled Top
Smoother Design
Small compact cabinet
Recessed access handles

Precedent™ Packaged Gas/Electric Convertible 3-5 Tons

Standard Features:

- Trane scroll compressors on all 3-5 ton units
- Colored and numbered wiring
- Phase Monitor, R-410A, 3 Phase Units
- Provisions for through the Base Gas and Condensate Drain Connections
- Crankcase Heaters
- 2" throwaway filters provided on all units
- Liquid Line Refrigerant Drier
- Operating Charge of R-410A
- IAQ Sloped Drain Pans
- Low Ambient to 40°F on Electromechanical models
- Low Ambient to 0°F on ReliaTel™ models
- 5 - year Limited Compressor Warranty
- 5 - year Limited Heat Exchanger Warranty
- 1 - year Limited Parts Warranty

Added Flexibility

- Electromechanical or ReliaTel™ controls (See page LPC-9 for ReliaTel™ Control Information)
- Standard or high efficiency cooling models available. 17+ available in 3-5T. For reference to 17+ please refer to publications RT-PRC048-EN and RT-SLB020-EN.
- Low, medium or high heat, single or two stage
- Convertible airflow
- Fork lift openings on three sides of unit
- Direct or belt drive - standard or oversized motors
- We don't prepackage options
- Choose options tailored to suit each job — pay only for what is needed
- Units ship with options installed — and within our standard ship cycle time

Factory Installed Options

- Through-the-Base — Electrical
- Convenience Outlet — Powered or unpowered
- Unit Disconnect Switch
- Circuit Breaker
- Smoke Detectors — Supply, return, or both
- Condenser Coil Coating
- Hinged Access Service Panels
- Discharge Air Sensor
- Fan Fail and Clogged Filter Switches
- Condenser Coil Guard — Hail Protection Quality
- Hot Gas Reheat Coil - Dehumidification (High Efficiency Units Only)
- Expansion valve and split face evaporator coil
- TCI (Trane Communications Interface)
- LonTalk® (Communications Interface)
- BACnet™ (Communications Interface)
- 2" Pleated Media filters (MERV 8 & 13)
- Froststat
- Multi-Speed & Single Zone VAV ID Airflow
- Demand Control Ventilation
- Stainless Steel Drainpan
- Condensate Drainpan Overflow Switch

The same Trane Quality and Reliability ... with added Flexibility!

For complete equipment / combination selections, installation instructions and warranty information, please refer to Product Data/Ratings and/or Installers Guides and Limited Warranty Handbooks.



It's Hard To Stop A Trane.®

Precedent™ Packaged Gas/Electric Convertible 3-5 Tons, 17 SEER, R-410A

Table LPG-2-A — Precedent™ 17 Plus - R-410A - ReliaTel™ Controls Only

Tons	Unit Ordering No.	Performance SEER	Cooling Capacity (Btuh)	Heating Output ^① Capacity (Btuh)	S.S. Furnace Eff%	Cabinet Dimensions (in.) H x W x L	Downflow Supply	Downflow Return	Shipping Weight (lbs.)	MCA**	Max. Fuse**
YHC - 208-230/3/60 - Three Phase - Low Heat											
3	YHC037E3RLA005D	17.5	36,500	48,000	78	36 x 44 x 69	18 x 15.5	24 x 14	676	24	30
4	YHC047E3RLA005D	17.5	50,500	49,000	80	41 x 53 x 88	33 x 17.5	32 x 17.5	858	30	40
5	YHC067E3RLA005D	17.2	60,000	49,000	80	41 x 53 x 88	33 x 17.5	32 x 17.5	917	33	45
YHC - 460/3/60 - Three Phase - Low Heat											
3	YHC037E4RLA005D	17.5	36,500	48,000	78	36 x 44 x 69	18 x 15.5	24 x 14	676	12	15
4	YHC047E4RLA005D	17.5	50,500	49,000	80	41 x 53 x 88	33 x 17.5	32 x 17.5	858	14	20
5	YHC067E4RLA005D	17.2	60,000	49,000	80	41 x 53 x 88	33 x 17.5	32 x 17.5	917	16	20
YHC - 575/3/60 - Three Phase - Low Heat											
3	YHC037EWRLA005D	17.5	36,500	48,000	78	36 x 44 x 69	18 x 15.5	24 x 14	676	9	15
4	YHC047EWRLA005D	17.5	50,500	49,000	80	41 x 53 x 88	33 x 17.5	32 x 17.5	858	11	15
5	YHC067EWRLA005D	17.2	60,000	49,000	80	41 x 53 x 88	33 x 17.5	32 x 17.5	917	12	15
YHC - 208-230/3/60 - Three Phase - Medium Heat											
3	YHC037E3RMA005D	17.5	36,500	64,000	78	36 x 44 x 69	18 x 15.5	24 x 14	676	24	30
4	YHC047E3RMA005D	17.5	50,500	64,000	80	41 x 53 x 88	33 x 17.5	32 x 17.5	858	30	40
5	YHC067E3RMA005D	17.2	60,000	64,000	80	41 x 53 x 88	33 x 17.5	32 x 17.5	917	33	45
YHC - 460/3/60 - Three Phase - Medium Heat											
3	YHC037E4RMA005D	17.5	36,500	64,000	78	36 x 44 x 69	18 x 15.5	24 x 14	676	12	15
4	YHC047E4RMA005D	17.5	50,500	64,000	80	41 x 53 x 88	33 x 17.5	32 x 17.5	858	14	20
5	YHC067E4RMA005D	17.2	60,000	64,000	80	41 x 53 x 88	33 x 17.5	32 x 17.5	917	16	20
YHC - 575/3/60 - Three Phase - Medium Heat											
3	YHC037EWRMA005D	17.5	36,500	64,000	78	36 x 44 x 69	18 x 15.5	24 x 14	676	9	15
4	YHC047EWRMA005D	17.5	50,500	64,000	80	41 x 53 x 88	33 x 17.5	32 x 17.5	858	11	15
5	YHC067EWRMA005D	17.2	60,000	64,000	80	41 x 53 x 88	33 x 17.5	32 x 17.5	917	12	15
YHC - 208-230/3/60 - Three Phase - High Heat											
3	YHC037E3RMA005D	17.5	36,500	80,000	78	36 x 44 x 69	18 x 15.5	24 x 14	676	24	30
4	YHC047E3RMA005D	17.5	50,500	96,000	80	41 x 53 x 88	33 x 17.5	32 x 17.5	858	30	40
5	YHC067E3RMA005D	17.2	60,000	104,000	80	41 x 53 x 88	33 x 17.5	32 x 17.5	917	33	45
YHC - 460/3/60 - Three Phase - High Heat											
3	YHC037E4RMA005D	17.5	36,500	80,000	78	36 x 44 x 69	18 x 15.5	24 x 14	676	12	15
4	YHC047E4RMA005D	17.5	50,500	96,000	80	41 x 53 x 88	33 x 17.5	32 x 17.5	858	14	20
5	YHC067E4RMA005D	17.2	60,000	104,000	80	41 x 53 x 88	33 x 17.5	32 x 17.5	917	16	20
YHC - 575/3/60 - Three Phase - High Heat											
3	YHC037EWRMA005D	17.5	36,500	80,000	78	36 x 44 x 69	18 x 15.5	24 x 14	676	9	15
4	YHC047EWRMA005D	17.5	50,500	96,000	80	41 x 53 x 88	33 x 17.5	32 x 17.5	858	11	15
5	YHC067EWRMA005D	17.2	60,000	104,000	80	41 x 53 x 88	33 x 17.5	32 x 17.5	917	12	15

① Downflow Airflow/Horizontal Airflow

** Information subject to change. Please confirm with current Product Data/Service Facts for current factory production.

Light Commercial Packaged Gas/Electric



It's Hard To Stop A Trane.®

Precedent™ Packaged Gas/Electric Convertible 3-5 Tons, 15 SEER, R-410A

Light Commercial Packaged Gas/Electric

Table LPG-3-A - Base Unit - 15 SEER High Efficiency - Electromechanical or ReliaTel™

Tons	Unit Ordering No.	Performance SEER	Cooling Capacity (Btuh)	Heating Output [Ⓢ] Capacity (Btuh)	AFUE/S.S. Furnace Eff%	Cabinet Dimensions (in.) H x W x L	Downflow Supply	Downflow Return	Shipping Weight (lbs.)	MCA**	Max. Fuse**
YHC - 208-230/3/60 - Three Phase - Low Heat											
3	YHC036E3*LA005D	15.0	37,600	48,000	78	36 x 44 x 69	18 x 15.5	24 x 14	637	21	30
4	YHC048F3*LA005D	15.0	49,930	49,000	80	41 x 53 x 88	33 x 17.5	32 x 17.5	869	26	35
5	YHC060F3*LA005D	15.0	61,000	49,000	80	41 x 53 x 88	33 x 17.5	32 x 17.5	894	30	45
YHC - 460/3/60 - Three Phase - Low Heat											
3	YHC036E4*LA005D	15.0	37,600	48,000	78	36 x 44 x 69	18 x 15.5	24 x 14	637	12	15
4	YHC048F4*LA005D	15.0	49,930	49,000	80	41 x 53 x 88	33 x 17.5	32 x 17.5	869	13	15
5	YHC060F4*LA005D	15.0	61,000	49,000	80	41 x 53 x 88	33 x 17.5	32 x 17.5	894	14	20
YHC - 575/3/60 - Three Phase - Low Heat											
3	YHC036EW*LA005D	14.4	37,600	48,000	78	36 x 44 x 69	18 x 15.5	24 x 14	637	10	15
4	YHC048FW*LA005D	15.0	49,930	49,000	80	41 x 53 x 88	33 x 17.5	32 x 17.5	869	11	15
5	YHC060FW*LA005D	15.0	61,000	49,000	80	41 x 53 x 88	33 x 17.5	32 x 17.5	894	11	15
YHC - 208-230/3/60 - Three Phase - Medium Heat											
3	YHC036E3*MA005D	15.0	37,600	64,000	78	36 x 44 x 69	18 x 15.5	24 x 14	676	21	30
4	YHC048F3*MA005D	15.0	49,930	64,000	79	41 x 53 x 88	33 x 17.5	32 x 17.5	858	26	35
5	YHC060F3*MA005D	15.0	61,000	64,000	79	41 x 53 x 88	33 x 17.5	32 x 17.5	917	30	45
YHC - 460/3/60 - Three Phase - Medium Heat											
3	YHC036E4*MA005D	15.0	37,600	64,000	78	36 x 44 x 69	18 x 15.5	24 x 14	676	12	15
4	YHC048F4*MA005D	15.0	49,930	64,000	79	41 x 53 x 88	33 x 17.5	32 x 17.5	858	13	15
5	YHC060F4*MA005D	15.0	61,000	64,000	79	41 x 53 x 88	33 x 17.5	32 x 17.5	917	14	20
YHC - 575/3/60 - Three Phase - Medium Heat											
3	YHC036EW*MA005D	14.4	37,600	64,000	78	36 x 44 x 69	18 x 15.5	24 x 14	676	10	15
4	YHC048FW*MA005D	15.0	49,930	64,000	79	41 x 53 x 88	33 x 17.5	32 x 17.5	858	11	15
5	YHC060FW*MA005D	15.0	61,000	64,000	79	41 x 53 x 88	33 x 17.5	32 x 17.5	917	11	15
YHC - 208-230/3/60 - Three Phase - High Heat											
3	YHC036E3*HA005D	15.0	37,600	96,000	78	36 x 44 x 69	18 x 15.5	24 x 14	676	21	30
4	YHC048F3*HA005D	15.0	49,930	96,000	79	41 x 53 x 88	33 x 17.5	32 x 17.5	858	26	35
5	YHC060F3*HA005D	15.0	61,000	104,000	80	41 x 53 x 88	33 x 17.5	32 x 17.5	917	30	45
YHC - 460/3/60 - Three Phase - High Heat											
3	YHC036E4*HA005D	15.0	37,600	96,000	78	36 x 44 x 69	18 x 15.5	24 x 14	676	12	15
4	YHC048F4*HA005D	15.0	49,930	96,000	79	41 x 53 x 88	33 x 17.5	32 x 17.5	858	13	15
5	YHC060F4*HA005D	15.0	61,000	104,000	80	41 x 53 x 88	33 x 17.5	32 x 17.5	917	14	20
YHC - 575/3/60 - Three Phase - High Heat											
3	YHC036EW*HA005D	14.4	37,600	96,000	78	36 x 44 x 69	18 x 15.5	24 x 14	676	10	15
4	YHC048FW*HA005D	15.0	49,930	96,000	79	41 x 53 x 88	33 x 17.5	32 x 17.5	858	11	15
5	YHC060FW*HA005D	15.0	61,000	104,000	80	41 x 53 x 88	33 x 17.5	32 x 17.5	917	11	15

Ⓢ Downflow Airflow/Horizontal Airflow

* Digit 9-E=Electromechanical or R=ReliaTel™.

** Information subject to change. Please confirm with current Product Data/Service Facts for current factory production.



It's Hard To Stop A Trane.®

Precedent™ Packaged Gas/Electric Convertible 3-5 Tons, 14 SEER, R-410A

Table LPG-4-A - Base Unit - 14 SEER - Electromechanical or ReliaTel™

Tons	Unit Ordering No.	Performance SEER	Cooling Capacity (Btuh)	Heating Output ^① Capacity Lo/Hi (Btuh)	AFUE%	Cabinet Dimensions (in.) H x W x L	Downflow Supply	Downflow Return	Shipping Weight (lbs.)	MCA**	Max. Fuse**
YSC - 208/230/3/60 - Three Phase - Low Heat											
3	YSC036G3*LB005D	14.0	37,000	44,800/64,000	82	41 x 44 x 69	18 x 15.5	24 x 14	577	20	30
4	YSC048G3*LB005D	14.0	49,000	44,800/64,000	82	41 x 44 x 69	18 x 15.5	24 x 14	598	26	35
5	YSC060G3*LB005D	14.0	60,000	44,800/64,000	82	41 x 44 x 69	18 x 15.5	24 x 14	627	29	40
YSC - 460/3/60 - Three Phase - Low Heat											
3	YSC036G4*LB005D	14.0	37,000	44,800/64,000	82	41 x 44 x 69	18 x 15.5	24 x 14	577	10	15
4	YSC048G4*LB005D	14.0	49,000	44,800/64,000	82	41 x 44 x 69	18 x 15.5	24 x 14	598	11	15
5	YSC060G4*LB005D	14.0	60,000	44,800/64,000	82	41 x 44 x 69	18 x 15.5	24 x 14	627	13	15
YSC - 575/3/60 - Three Phase - Low Heat											
3	YSC036GW*LB005D	14.0	37,000	44,800/64,000	82	41 x 44 x 69	18 x 15.5	24 x 14	577	8	15
4	YSC048GW*LB005D	14.0	49,000	44,800/64,000	82	41 x 44 x 69	18 x 15.5	24 x 14	598	10	15
5	YSC060GW*LB005D	14.0	60,000	44,800/64,000	82	41 x 44 x 69	18 x 15.5	24 x 14	627	10	15
YSC - 208/230/3/60 - Three Phase - Medium Heat											
3	YSC036G3*MB005D	14.0	37,000	56,000/80,000	82	41 x 44 x 69	18 x 15.5	24 x 14	577	20	30
4	YSC048G3*MB005D	14.0	49,000	56,000/80,000	82	41 x 44 x 69	18 x 15.5	24 x 14	598	26	35
5	YSC060G3*MB005D	14.0	60,000	56,000/80,000	82	41 x 44 x 69	18 x 15.5	24 x 14	627	29	40
YSC - 460/3/60 - Three Phase - Medium Heat											
3	YSC036G4*MB005D	14.0	37,000	56,000/80,000	82	41 x 44 x 69	18 x 15.5	24 x 14	577	10	15
4	YSC048G4*MB005D	14.0	49,000	56,000/80,000	82	41 x 44 x 69	18 x 15.5	24 x 14	598	11	15
5	YSC060G4*MB005D	14.0	60,000	56,000/80,000	82	41 x 44 x 69	18 x 15.5	24 x 14	627	13	15
YSC - 575/3/60 - Three Phase - Medium Heat											
3	YSC036GW*MB005D	14.0	37,000	56,000/80,000	82	41 x 44 x 69	18 x 15.5	24 x 14	577	8	15
4	YSC048GW*MB005D	14.0	49,000	56,000/80,000	82	41 x 44 x 69	18 x 15.5	24 x 14	598	10	15
5	YSC060GW*MB005D	14.0	60,000	56,000/80,000	82	41 x 44 x 69	18 x 15.5	24 x 14	627	10	15
YSC - 208/230/3/60 - Three Phase - High Heat											
3	YSC036G3*HB005D	14.0	37,000	67,200/96,000	82	41 x 44 x 69	18 x 15.5	24 x 14	577	20	30
4	YSC048G3*HB005D	14.0	49,000	72,800/104,000	82	41 x 44 x 69	18 x 15.5	24 x 14	598	26	35
5	YSC060G3*HB005D	14.0	60,000	84,000/120,000	82	41 x 44 x 69	18 x 15.5	24 x 14	627	29	40
YSC - 460/3/60 - Three Phase - High Heat											
3	YSC036G4*HB005D	14.0	37,000	67,200/96,000	82	41 x 44 x 69	18 x 15.5	24 x 14	577	10	15
4	YSC048G4*HB005D	14.0	49,000	72,800/104,000	82	41 x 44 x 69	18 x 15.5	24 x 14	598	11	15
5	YSC060G4*HB005D	14.0	60,000	84,000/120,000	82	41 x 44 x 69	18 x 15.5	24 x 14	627	13	15
YSC - 575/3/60 - Three Phase - High Heat											
3	YSC036GW*HB005D	14.0	37,000	67,200/96,000	82	41 x 44 x 69	18 x 15.5	24 x 14	577	8	15
4	YSC048GW*HB005D	14.0	49,000	72,800/104,000	82	41 x 44 x 69	18 x 15.5	24 x 14	598	10	15
5	YSC060GW*HB005D	14.0	60,000	84,000/120,000	82	41 x 44 x 69	18 x 15.5	24 x 14	627	10	15

① Downflow Airflow/Horizontal Airflow

* Digit 9-E=Electromechanical or R=ReliaTel™.

** Information subject to change. Please confirm with current Product Data/Service Facts for current factory production.

Light Commercial Packaged Gas/Electric



It's Hard To Stop A Trane.®

Precedent™ Packaged Gas/Electric Convertible 3-5 Tons (Model Digit Numbers)

Light Commercial
Packaged Gas/Electric

Digit	Description	Order Number	Digit	Description	Order Number
1-8	Main Assembly (see previous page)		20	Convenience Outlet	
9	Unit Controls			No Convenience Outlet	0
	Electromechanical	E		Unpowered Convenience Outlet	A
	ReliaTel™ Micro-processor	R		Powered Convenience Outlet (three-phase only)®	B
10	Heating Capacity		21	Communications Options®	
	Low	L		No Communications Interface	0
	Medium	M		Trane Communications Interface	1
	High	H		LonTalk® Communications Interface	2
	Low - Stainless Steel Heat Exchanger	X		BACnet™ Communications Interface	6
	Medium - Stainless Steel Heat Exchanger	Y	22	Refrigeration System Option	
	High - Stainless Steel Heat Exchanger	Z		Standard Refrigeration System®	0
11	Design Sequence	*		Dehumidification Option®②②	B
12-13	Service Sequence		23	Refrigeration Controls	
	First Sequence (Factory assigned)	*,*		<i>Note: Applicable to Digit 7 = E, F</i>	
14	Fresh Air Selection			No Refrigeration Control®	0
	No Fresh Air	0		Frostat®②	1
	Manual Outside Air Damper 0-50%®	A	24	Smoke Detector®	
	Motorized Outside Air Damper 0-50%®	B		No Smoke Detector	0
	Economizer, Dry Bulb 0-100% without Barometric Relief®	C		Return Air Smoke Detector®②	A
	Economizer, Dry Bulb 0-100% with Barometric Relief®	D		Supply Air Smoke Detector	B
	Economizer, Reference Enthalpy 0-100% without Barometric Relief®⑦	E		Supply and Return Air Smoke Detectors®②	C
	Economizer, Reference Enthalpy 0-100% with Barometric Relief®⑦	F		Plenum Smoke Detector	D
	Economizer, Comparative Enthalpy 0-100% without Barometric Relief®⑦	G	25	System Monitoring Controls	
	Economizer, Comparative Enthalpy 0-100% with Barometric Relief®⑦	H		No Monitoring Control®	0
	Low Leak Economizer, Dry Bulb with Barometric Relief	K		Clogged Filter Switch®	1
	Low Leak Economizer, Comparative Enthalpy with Barometric Relief	M		Fan Failure Switch®	2
	Low Leak Economizer, Reference Enthalpy with Barometric Relief	P		Discharge Air SensingTube®	3
15	Supply Fan/Drive Type/Motor			Clogged Filter Switch and Fan Failure Switch®	4
	Standard Drive®	0		Clogged Filter Switch and Discharge Air SensingTube®	5
	Oversized Motor	1		Fan Failure Switch and Discharge Air SensingTube®	6
	Optional Belt Drive Motor®	2		Clogged Filter Switch, Fan Failure Switch and Discharge Air SensingTube®	7
	Single Zone VAV®	6		Condensate Drain Pan Overflow Switch	A
	Multi-Speed Indoor Fan®	7		Clogged Filter Switch® and Condensate Drain Pan Overflow Switch	B
	VAV Supply Air Temperature Control Standard Motor®	E		Fan Failure Switch® and Condensate Drain Pan Overflow Switch	C
16	Hinged Service Access/Filters			Discharge Air Sensing® and Condensate Drain Pan Overflow Switch	D
	Standard Panels/Standard Filters	0		Clogged Filter Switch®, Fan Failure Switch® and Condensate Drain Pan Overflow Switch	E
	Hinged Access Panels/Standard Filters	A		Clogged Filter Switch®, Discharge Air SensingTube® and Condensate Drain Pan Overflow Switch	F
	Standard Panels/2" MERV 8 Filters	B		Fan Failure Switch, Discharge Air SensingTube® and Condensate Drain Pan Overflow Switch	G
	Hinged Access Panels/2" MERV 8 Filters	C		Clogged Filter Switch®, Fan Failure Switch®, Discharge Air Sensing® and Condensate Drain Pan Overflow Switch	H
	Standard Panels/2" MERV 13 Filters	D	26	System Monitoring Controls	
	Hinged Access Panels/2" MERV 13 Filters	E		No Monitoring Controls	0
17	Condenser Coil Protection			Demand Control Ventilation (CO ₂)®③	A
	Standard Coil	0	27	Unit Hardware Enhancements	
	Standard Coil with Hail Guard	1		No Enhancements	0
	Black Epoxy Pre-Coated Condenser Coil®	2		Stainless Steel Drain Pan	1
	Black Epoxy Pre-Coated Condenser Coil with Hail Guard®	3	31	Advanced Unit Controls	
	CompleteCoat™ Condenser Coil	4		Standard Unit Controls	0
	CompleteCoat™ Condenser Coil with Hail Guard	5		Human Interface	1
18	Through the Base Provisions				
	<i>Note: Applicable to Digit 1, T or Y models</i>				
	No Through-the-Base Provisions	0			
	Through-the-Base Electric®	A			
	<i>Note: Applicable to Digit 1, Y models only</i>				
	Through-the-Base Gas Piping®	B			
	Through-the-Base Electric and Gas Piping®	C			
19	Disconnect/Circuit Breaker (three-phase only)				
	No Disconnect/No Circuit Breaker	0			
	Unit Mounted Non-Fused Disconnect®	1			
	Unit Mounted Circuit Breaker®	2			

See Footnotes ①-② next page.

For complete equipment / combination selections, installation instructions and warranty information, please refer to Product Data/Ratings and/or Installers Guides and Limited Warranty Handbooks.



It's Hard To Stop A Trane.®

Precedent™ Packaged Gas/Electric Convertible 3-5 Tons (Model Digit Numbers)

Light Commercial Packaged Gas/Electric

- ① Available on 3-5 Ton models.
- ② Standard on 4-5 Ton E3,4,W and all High Efficiency models
- ③ Not available with electromechanical controls.
- ④ Manual outside air damper will ship factory supplied within the unit, but must be field installed.
- ⑤ High pressure control is standard on all units.
- ⑥ On 3-5 ton, multispeed direct drive is standard on single phase and 15 SEER.
- ⑦ Economizer with Barometric Relief is for downflow configured units only. Order Economizer without Barometric Relief for horizontal configuration. Barometric Relief for horizontal configured units must be ordered as field installed accessory.
- ⑧ Through the base electric required when ordering disconnect/circuit breaker options.
- ⑨ Requires use of Disconnect or Circuit Breaker.

Digit 15 Selection Details

Digit 15 = 0

Standard Efficiency

3 Phase (3 to 5 Ton) = Multispeed Direct Drive Motor

High Efficiency

1 Phase = High Efficiency Multispeed Direct Drive Motor

3 Phase (3 to 5 ton) = High Efficiency Multispeed Direct Drive Motor

3 Phase (3 to 5 ton w/Dehumidification) = Belt Drive Motor

Digit 15 = 2

Standard Efficiency

3 Phase = Not Available

High Efficiency

1 Phase = Not Available

Not Available

High Efficiency: 3-5 ton w/Standard Indoor Motor w/460V

- ⑩ Standard metering devices are TXVs.
- ⑪ Froststat cannot be field installed in electro-mechanical units.
- ⑫ The return air smoke detector may not fit up or work properly on the Precedent units when used in conjunction with 3rd party accessories such as bolt on heat wheels, economizers and power exhaust. Do not order the return air smoke detectors when using this type of accessory.

- ⑬ Return Air Smoke Detector cannot be ordered with Novar Controls.
- ⑭ These options are standard when ordering Novar Controls.
- ⑮ This option is used when ordering Novar Controls.
- ⑯ Includes gas piping and shutoff (field assembly required).
- ⑰ Not available with high temperature duct sensor accessory.
- ⑱ Digit 15 = 2
- ⑲ Novar Sensor utilized with Digit 21 = (4) Novar 3051 Controls without Zone Sensor.
- ⑳ Available for T/Y 10 ton standard efficiency models only.
- ㉑ Available for T/Y 3, 4, 5, 6, 7½, 8½ ton standard/high efficiency models only.
- ㉒ Requires selection of 2" Pleated Filters (option B or C) for Digit 16.
- ㉓ Not available on 6 ton units and all single phase or standard efficiency.
- ㉔ Standard on T/YSC 6, 7½ (single and dual systems), 8½, 10 ton standard efficiency models and T/YHC 4, 5, 6, 7½ ton high efficiency models (except for dehumidification models).
- ㉕ Standard on T/YSC 6 (single and dual systems) ton standard efficiency models and T/YHC 4, 5, ton high efficiency models (except for dehumidification models)
- ㉖ Epoxy coil and epoxy with hailguard options are not available for units with microchannel condenser coil.
- ㉗ N/A
- ㉘ N/A
- ㉙ Motorized Outside Air Damper is not available on Multi-Speed or SZVAV (Single Zone Variable Air Volume) products.
- ㉚ Froststat standard on Multi-Speed and SZVAV (Single Zone Variable Air Volume) products.
- ㉛ Novar is not available with SZVAV products.
- ㉜ Demand Control Ventilation not available with electromechanical controls.
- ㉝ Demand Control Ventilation Option includes wiring only. The CO₂ sensor is a field-installed only option.
- ㉞ When ordering Dehumidification option, digit #7 will revert back to E, not F.



It's Hard To Stop A Trane.®

Precedent™ Packaged Gas/Electric Convertible 3-5 Tons Accessories

Light Commercial Packaged Gas/Electric

Table LPG-7-A – Accessories

Model Number	Description	Used With®
BAYABRD001*③	ReliaTel™ Options Module	All Precedents
BAYASCT001*⑦⑧	Anti-Short-Cycle Timer	All Precedents w/ Electromechanical
BAYBARM010*⑥	Barometric Relief	YSC036-060, YHC036, YHC037
BAYBARM011*⑥	Barometric Relief	YSC048-060, YHC047-067
BAYBCIR200*	BACnet™ Communication Interface	All Precedents w/ ReliaTel™
BAYCURB042 / FIACURB401*②	Roof Curb	YSC036-060, YHC036, YHC037
BAYCURB043 / FIACURB402*②	Roof Curb	YHC047-067
BAYDFPS003*③⑥	Clogged Filter Switch (MERV 8)	All Precedents
BAYDFPS014*	Clogged Filter Switch (MERV 13)	All Precedents
BAYDFPS004*③⑥	Fan Failure Switch	All Precedents
BAYDMPR053*	0-50% Manual Outside Air Damper	YSC036-060, YHC036, YHC037
BAYDMPR056*	0-50% Manual Outside Air Damper	YHC047-067
BAYDMPR051*③	0-50% Motorized Outside Air Damper	YSC036-060, YHC036, YHC037 (ReliaTel™)
BAYDMPR052*⑦	0-50% Motorized Outside Air Damper	YSC036-060, YHC036 (Electromechanical)
BAYDMPR054*③	0-50% Motorized Outside Air Damper	YHC047-067 (ReliaTel™)
BAYDMPR055*⑦	0-50% Motorized Outside Air Damper	YHC048-060 (Electromechanical)
BAYECON085*③	0-100% Dry Bulb Economizer	YSC036-060, YHC036, YHC037 (ReliaTel™)
BAYECON086*⑦	0-100% Dry Bulb Economizer	YSC036-060, YHC036 (Electromechanical)
BAYECON087*③	0-100% Dry Bulb Economizer	YHC047-067 (ReliaTel™)
BAYECON088*⑦	0-100% Dry Bulb Economizer	YHC048-060 (Electromechanical)
BAYECON704*	Downflow Low Leak Economizer	YSC072-120, YHC047-120 (ReliaTel™)
BAYECON705*	Downflow Low Leak Economizer	YSC036-060, YHC036, YHC037 (ReliaTel™)
BAYENTH300*	Reference Enthalpy Kit (Solid State)	BAYECON086B, 088B (Electromechanical)
BAYENTH301*	Comparative Enthalpy Kit (Solid State)	BAYECON086B, 088B (Electromechanical)
BAYENTH005*①	Reference Enthalpy Kit	BAYECON085A, 087A (ReliaTel™)
BAYENTH006*①	Comparative Enthalpy Kit	BAYECON085A, 087A (ReliaTel™)
BAYFRST003*③④	High Temperature Stat	All Precedents
BAYGARD237*	Condenser Coil Hail Guard	YHC036, YHC037
BAYGARD240*	Condenser Coil Hail Guard	YSC072-090, YHC047-067
BAYGARD437*	Condenser Coil Hail Guard	YSC036-060
BAYGARD241*	Condenser Coil Hail Guard	YHC072-067
BAYHAKT011*	High Altitude Kit	YSC036-060G
BAYHAKT010*	High Altitude Kit	YHC036-067

- ① Kits contain all necessary parts to achieve desired level of enthalpy control.
- ② Lynn Haven Manufacturing has a No-Return policy for this roof curb.
- ③ For use with ReliaTel™ controlled units only.
- ④ Cannot be used in conjunction with factory installed Smoke Detector option.
- ⑤ Installs in ductwork for horizontal configuration. For downflow configuration, it installs in the unit's horizontal return duct. See Installer's Guide for more information.
- ⑥ BAYABRD001* is required when ordering field installed accessories Clogged Filter Switch (BAYDFPS003*), Fan Fail Switch (BAYDFPS004*), Discharge Air Sensing Kit (BAYTUBE004* or BAYTUBE005*) or Evaporator Defrost Control (Frostat) (BAYLOAM020*) Ventilation Override Kit (BAYVNOR001*) unless the following options are factory installed: Frostat, Smoke Detector, Clogged Filter Switch, Fan Failure Switch, Discharge Air Sensing Kit. **These factory installed options include the ReliaTel™ Options Module.**
- ⑦ Electromechanical controlled units only
- ⑧ Activated on Power on.
- ⑨ Field installed accessory. Requires an economizer.
- ⑩ The manual outside air damper will ship factory supplied within the unit, but must be field installed.
- Ⓜ A=R-22, E=410A
- * Parts designator subject to change

For complete equipment / combination selections, installation instructions and warranty information, please refer to Product Data/Ratings and/or Installers Guides and Limited Warranty Handbooks.



It's Hard To Stop A Trane.®

Precedent™ Packaged Gas/Electric Convertible 3-5 Tons Accessories

Table LPG-8-A — Accessories

Model Number	Description	Used With
BAYICSI003* ^{④⑦}	Trane Communications Interface (TCI)	All Precedents (ReliaTel™)
BAYLMSW001* ^⑩	Power Exhaust Limit Switch	All Precedents
BAYLOAM020* ^⑤	Evaporator Defrost Control (Frostat)	YHC036-067E*R,
BAYLOAM120*	Evaporator Defrost Control (Frostat)	YSC036-060G*R (ReliaTel™)
BAYLTCI002* ^④	LonTalk® Communications Interface (LCI)	All Precedents (ReliaTel™)
BAYLPKT029* ^③	LP Conversion Kit	YSC036-060*L/M/H, YSC072*H, YSC090-102*M/H, YSC120*L/M/H
BAYLPKT050* ^⑩	LP Conversion Kit	YHC036-067*L/M/H
BAYPWRX026*	Power Exhaust (208-230V)	YHC047-067*3
BAYPWRX027*	Power Exhaust (460V)	YHC047-120*4
BAYPWRX028*	Power Exhaust (575V)	YHC047-067*W
BAYPWRX070*	Power Exhaust (208-230V)	YSC036-060*3, YHC036-067*3
BAYPWRX071*	Power Exhaust (460V)	YSC036-060*4, YHC036-067*4
BAYPWRX072*	Power Exhaust (575V)	YSC036-060*W, YHC036-067*W
BAYQACB009* ^{②⑤}	Quick Adapt Roof Curb	YSC036-060, YHC036, YHC037
BAYQACB010* ^{②⑤}	Quick Adapt Roof Curb	YSC036-060, YHC036, YHC037
BAYQACB011* ^{②⑦}	Quick Adapt Roof Curb	YHC047-067
BAYQACB012* ^{②⑦}	Quick Adapt Roof Curb	YHC047-067
BAYQACB013 / FIAQACB027* ^{②⑦}	Quick Adapt Roof Curb	YHC047-067
BAYQACB114 / FIAQACB044* ^{②⑤}	Quick Adapt Roof Curb	YHC048-067H
BAYQACB115* ^{②⑤}	Quick Adapt Roof Curb	YHC048-067H
BAYRTEM001* ^⑩	Fully Featured ReliaTel™ Economizer Logic Model	All Precedents
BAYSENS016* ^④	Temperature Sensor	All Precedents
BAYCO2K003* ^②	CO2 Duct Mounted, Sensor Only	All Precedents (ReliaTel™)
BAYCO2K001* ^②	CO2 Wall Mounted, Sensor Only	All Precedents (ReliaTel™)
BAYSERV001* ^④	Selection Resistance Service Tester	All Precedents
BAYSTAT023*	Remote Potentiometer	All Precedents
BAYTUBE004* ^{②④⑤}	Discharge Air Sensing Kit	YHC036-037 (ReliaTel™)
BAYTUBE006* ^{②④⑤}	Discharge Air Sensing Kit	YHC047-067*R (ReliaTel™)
BAYTUBE104*	Discharge Air Sensing Kit	YSC036-060 (ReliaTel™)
BAYVNOR001* ^{④⑤⑥}	Ventilation Override Kit	All Precedents

① For use with ReliaTel™ microprocessor controlled units only. Must be factory installed for Electromechanical controlled units.

② Used for true discharge air sensing in both heating and cooling. Required for supply air tempering.

③ Lynn Haven Manufacturing has a No-Return policy for this roof curb.

④ For use with ReliaTel™ controlled units only.

⑤ BAYABRD001* is required when ordering field installed accessories Clogged Filter Switch (BAYDFPS003*), Fan Fail Switch (BAYDFPS004*), Discharge Air Sensing Kit (BAYTUBE004* or BAYTUBE005*) or Evaporator Defrost Control (Frostat) (BAYLOAM020*) Ventilation Override Kit (BAYVNOR001*) unless the following options are factory installed: Frostat, Smoke Detector, Clogged Filter Switch, Fan Failure Switch, Discharge Air Sensing Kit. These factory installed options include the ReliaTel™ Options Module.

⑥ BAYQACB009* adapts Voyager BAYCURB021* to accept Precedent 3 -5 ton unit. BAYQACB010* adapts Voyager BAYCURB022* to accept Precedent 3-5 ton unit. BAYQACB012* adapts Voyager BAYCURB025* to accept Precedent 6-10 ton unit. BAYQACB013* adapts Voyager BAYCURB026* to accept Precedent 6-10 ton unit. BAYQACB011* adapts Voyager BAYCURB022* to accept Precedent 6-10 ton unit.

⑦ Interface allows 3-10 ton units with ReliaTel™ Controls to communicate with Tracer 100, Tracker, VariTrac II, and is the preferred method of communication to Tracer Summit.

⑧ Power Exhaust cannot be used with Barometric Relief. Order Economizer without Barometric Relief.

⑨ Field installed accessory. Requires an economizer.

⑩ A=R-22, E=410A

⑪ When ordering a field installed power exhaust on a unit with electromechanical controls, BAYLMSW001* must be ordered.

⑫ If any version of comparative or reference enthalpy is ordered, BAYRTEM001* does not need to be ordered.

⑬ Order only when unit has factory installed Demand Control Ventilation option.

⑭ BAYLPKT029 is for 2 stage gas units. If 036-060 model has digit 7=G AND digit 11=B, it's a 2 stage gas unit. Use BAYLPKT029.

⑮ BAYLPKT050 is for 1 stage gas units. If 036-060 model has digit 7=G AND digit 11=A, it's a 1 stage gas unit. Use BAYLPKT050.

⑯ Precedent E cabinet to Precedent D cabinet (BAYCURB044 to BAYCURB043)

⑰ Precedent B cabinet to Precedent C cabinet (BAYCURB042 to BAYCURB043)

* Parts designator subject to change

For complete equipment / combination selections, installation instructions and warranty information, please refer to Product Data/Ratings and/or Installers Guides and Limited Warranty Handbooks.

Light Commercial
Packaged Gas/Electric



It's Hard To Stop A Trane.®

Precedent™ Packaged Gas/Electric Convertible 3-5 Tons Zone Sensors / Thermostats

Light Commercial
Packaged Gas/Electric

Table LPG-9-A — Zone Sensors for ReliaTel™ Controlled Units

Model Number	Description	Used With
BAYSENS036* ^③	Wall-Mounted Humidity Zone Sensor	Y*C036-060 ^⑥ R, YHC037-067 ^⑥ R
BAYSENS037* ^③	Duct-Mounted Humidity Zone Sensor	Y*C036-060* ^⑥ R, YHC037-067 ^⑥ R
BAYSENS073* ^①	Room Sensor w/ Override and Cancel Buttons	Y*C036-120 ^⑥ , R, YHC037-067
BAYSENS074* ^①	Room Sensor w/ Temp. Adjustment with Override and Cancel Buttons	Y*C036-120 ^⑥ , R, YHC037-067
BAYSENS077*	Remote Room Sensor BAYSENS006B, 008B, 010B, 019C, 106A,108A,110A,119A	
BAYSENS106*	Single Setpoint Manual Changeover	Y*C036-060 ^⑥ R, YHC037-067 ^⑥ R
BAYSENS108*	Dual Setpoint Manual or Auto Changeover	Y*C036-060 ^⑥ R, YHC037-067 ^⑥ R
BAYSENS110*	Dual Setpoint Man. or Auto Change-over with System Function Lights	Y*C036-060 ^⑥ R, YHC037-067 ^⑥ R
BAYSENS119*	Programmable Night Setback w/System Function Lights	Y*C036-060 ^⑥ R, YHC037-067 ^⑥ R
BAYSENS135*	Digital Display Zone Sensor Function Lights	Y*C036-060 ^⑥ R, YHC037-067 ^⑥ R
BAYMTP110*	Retrofit Wall Cover from Horizontal to Vertical	Y*C036-060 ^⑥ R, YHC037-067 ^⑥ R
BAYSENS050* ^④	Digital Display Wireless Zone Sensor	Y*C036-060 ^⑥ R
BAYSENS924*	Programmable Zone Sensor - IECC/Title 24 ^⑤	Y*C036-060 ^⑥ R, YHC037-067 ^⑥ R

Table LPG-9-B — Thermostats

Model Number	Description	Used With
BAYSTAT150*	2H/2C Digital Display Programmable Thermostat	Y*C036-060 ^⑥ E
BAYSTAT152*	3H/2C Programmable Touchscreen Thermostat	Y*C036-060 ^⑥ E
BAYSTAT155*	3H/2C Digital Display Thermostat	Y*C036-060 ^⑥ E
BAYSTAT170*	Duct Mounted Return Air Sensor	BAYSTAT152*

① Used with Integrated Comfort™ Systems, any unit type. These sensors do not work with TCM. Consult BASD Marketing for them.

② Do not use with Programmable Thermostats.

③ For use with Dehumidification (Hot Gas Reheat) Coil Option.

④ Kit comes with everything required for installing & operation.

⑤ Must be used with ReliaTel™ Control and BCI Communications Interface.

⑥ Either standard or high efficiency models.

* Parts designator subject to change



It's Hard To Stop A Trane.®



Small compact cabinet
Recessed access handles

Precedent™ Packaged Gas/Electric with Symbio™ Convertible 6-25 Tons

Standard Features:

- Symbio 700 controller
- MultiSpeed Indoor
- Manifolded scroll compressors
- 6-17.5 tons = 3 stages of cooling; 20-25 tons = 4 stages of cooling
- Microchannel condenser and evaporator coils
- Colored, keyed, and numbered wiring
- Froststat
- Phase monitor
- Coil/Hailguards
- Crankcase heaters on all compressors
- 2" filters
- Backward curved direct drive plenum supply fan
- Liquid line refrigerant drier
- Operating Charge of R-410A
- Composite dual sloped drain pans
- Low Ambient cooling to 40°F
- 5 - year Limited Compressor Warranty
- 3 - year Limited Parts Warranty
- 10 - year Limited Aluminized Steel Heat Exchanger Warranty

Added Flexibility

- Standard or high efficiency cooling models available.
- Convertible airflow (ships in downflow application)
- 2" filters included
- Fork lift openings on three sides of unit
- Choose options tailored to suit each job — pay only for what is needed
- Units ship with options installed — and within our standard ship cycle time

Factory Installed Options

- Outdoor air dampers (manual or motorized)
- Economizers (Base or Low Leak)
- Dry Bulb, Reference Enthalpy, Comparative Enthalpy, or Differential Dry Bulb economizer control options
- Stainless steel tubular heat exchanger
- Through-the-Base — Electrical and/or Gas
- Convenience Outlet — Powered or unpowered
- Unit Disconnect Switch
- Smoke Detectors — Supply, return, or both
- Condenser Coil Coating
- Hinged Access Service Panels
- Discharge Air Sensor
- Low Ambient cooling to 0°F
- Clogged Filter Switch
- Dehumidification (Modulating Hot Gas Reheat)
- Symbio 700 BACnet® communication interface license
- Symbio 700 LonTalk® communication interface license
- 2" MERV 8 filters or 2" MERV 13 filters
- Single Zone or Multiple Zone VAV Indoor Airflow
- Demand Control Ventilation
- Stainless Steel Drainpan
- Condensate Drainpan Overflow Switch



It's Hard To Stop A Trane.®

Precedent™ Packaged Gas/Electric with Symbio™ Convertible 6 - 25 Tons, High Efficiency, R-410A

Light Commercial
Packaged Gas/Electric

Table LP-11-A – Base Unit— High Efficiency – R-410A – Symbio

Tons	Unit Ordering No.	Performance IEER(2-speed)/EER	Net Cooling Capacity (Btuh)	Cabinet Dimensions (in.) H x W x L	Cabinet	Shipping Weight (lbs.)	MCA**	Max Fuse**
YHJ – 208-230/3/60 – Three Phase - Low Heat								
6	YHJ072A3S0L0000	15.9/12.1	73,000	50 ⁷ / ₈ x 53 ¹ / ₄ x 88 ¹ / ₄	B	1107	38	50
7.5	YHJ090A3S0L0000	16.6/12.1	91,000	50 ⁷ / ₈ x 53 ¹ / ₄ x 88 ¹ / ₄	B	1111	42	50
8.5	YHJ102A3S0L0000	16.6/12.1	104,000	50 ⁷ / ₈ x 53 ¹ / ₄ x 88 ¹ / ₄	B	1127	48	60
10	YHJ120A3S0L0000	15.1/11.4	123,000	50 ⁷ / ₈ x 53 ¹ / ₄ x 88 ¹ / ₄	B	1137	54	70
12.5	YHJ150A3S0L0000	15.3/10.8	154,000	50 ⁷ / ₈ x 63 ¹ / ₈ x 99 ⁵ / ₈	C	1512	64	90
15	YHJ180A3S0L0000	17.5/11.9	185,000	59 x 87 x 123	D	2220	78	100
17.5	YHJ210A3S0L0000	15.7/11.6	215,000	59 x 87 x 123	D	2250	93	110
20	YHJ240A3S0L0000	16.3/10.8	247,000	59 x 87 x 123	D	2320	108	125
25	YHJ300A3S0L0000	15.6/10.6	282,000	59 x 87 x 123	D	2370	119	150
YHJ – 460/3/60 – Three Phase - Low Heat								
6	YHJ072A4S0L0000	15.9/12.1	73,000	50 ⁷ / ₈ x 53 ¹ / ₄ x 88 ¹ / ₄	B	1107	18	20
7.5	YHJ090A4S0L0000	16.6/12.1	91,000	50 ⁷ / ₈ x 53 ¹ / ₄ x 88 ¹ / ₄	B	1111	21	25
8.5	YHJ102A4S0L0000	16.6/12.1	104,000	50 ⁷ / ₈ x 53 ¹ / ₄ x 88 ¹ / ₄	B	1127	25	30
10	YHJ120A4S0L0000	15.1/11.4	123,000	50 ⁷ / ₈ x 53 ¹ / ₄ x 88 ¹ / ₄	B	1137	29	40
12.5	YHJ150A4S0L0000	15.3/10.8	154,000	50 ⁷ / ₈ x 63 ¹ / ₈ x 99 ⁵ / ₈	C	1512	33	45
15	YHJ180A4S0L0000	17.5/11.9	185,000	59 x 87 x 123	D	2220	41	50
17.5	YHJ210A4S0L0000	15.7/11.6	215,000	59 x 87 x 123	D	2250	49	60
20	YHJ240A4S0L0000	16.3/10.8	247,000	59 x 87 x 123	D	2320	54	70
25	YHJ300A4S0L0000	15.6/10.6	282,000	59 x 87 x 123	D	2370	59	80
YHJ – 575/3/60 – Three Phase - Low Heat								
6	YHJ072AWS0L0000	15.9/12.1	73,000	50 ⁷ / ₈ x 53 ¹ / ₄ x 88 ¹ / ₄	B	1107	15	15
7.5	YHJ090AWS0L0000	16.6/12.1	91,000	50 ⁷ / ₈ x 53 ¹ / ₄ x 88 ¹ / ₄	B	1111	17	20
8.5	YHJ102AWS0L0000	16.6/12.1	104,000	50 ⁷ / ₈ x 53 ¹ / ₄ x 88 ¹ / ₄	B	1127	19	25
10	YHJ120AWS0L0000	15.1/11.4	123,000	50 ⁷ / ₈ x 53 ¹ / ₄ x 88 ¹ / ₄	B	1137	22	30
12.5	YHJ150AWS0L0000	15.3/10.8	154,000	50 ⁷ / ₈ x 63 ¹ / ₈ x 99 ⁵ / ₈	C	1512	26	35
15	YHJ180AWS0L0000	17.5/11.9	185,000	59 x 87 x 123	D	2220	32	40
17.5	YHJ210AWS0L0000	15.7/11.6	215,000	59 x 87 x 123	D	2250	37	50
20	YHJ240AWS0L0000	16.3/10.8	247,000	59 x 87 x 123	D	2320	47	60
25	YHJ300AWS0L0000	15.6/10.6	282,000	59 x 87 x 123	D	2370	46	60
YHJ – 208-230/3/60 – Three Phase - Medium Heat								
6	YHJ072A3S0M0000	15.9/12.1	73,000	50 ⁷ / ₈ x 53 ¹ / ₄ x 88 ¹ / ₄	B	1107	38	50
7.5	YHJ090A3S0M0000	16.6/12.1	91,000	50 ⁷ / ₈ x 53 ¹ / ₄ x 88 ¹ / ₄	B	1111	42	50
8.5	YHJ102A3S0M0000	16.6/12.1	104,000	50 ⁷ / ₈ x 53 ¹ / ₄ x 88 ¹ / ₄	B	1127	48	60
10	YHJ120A3S0M0000	15.1/11.4	123,000	50 ⁷ / ₈ x 53 ¹ / ₄ x 88 ¹ / ₄	B	1137	54	70
12.5	YHJ150A3S0M0000	15.3/10.8	154,000	50 ⁷ / ₈ x 63 ¹ / ₈ x 99 ⁵ / ₈	C	1512	64	90
15	YHJ180A3S0M0000	17.5/11.9	185,000	59 x 87 x 123	D	2220	78	100
17.5	YHJ210A3S0M0000	15.7/11.6	215,000	59 x 87 x 123	D	2250	93	110
20	YHJ240A3S0M0000	16.3/10.8	247,000	59 x 87 x 123	D	2320	108	125
25	YHJ300A3S0M0000	15.6/10.6	282,000	59 x 87 x 123	D	2370	119	150
YHJ – 460/3/60 – Three Phase - Medium Heat								
6	YHJ072A4S0M0000	15.9/12.1	73,000	50 ⁷ / ₈ x 53 ¹ / ₄ x 88 ¹ / ₄	B	1107	18	20
7.5	YHJ090A4S0M0000	16.6/12.1	91,000	50 ⁷ / ₈ x 53 ¹ / ₄ x 88 ¹ / ₄	B	1111	21	25
8.5	YHJ102A4S0M0000	16.6/12.1	104,000	50 ⁷ / ₈ x 53 ¹ / ₄ x 88 ¹ / ₄	B	1127	25	30
10	YHJ120A4S0M0000	15.1/11.4	123,000	50 ⁷ / ₈ x 53 ¹ / ₄ x 88 ¹ / ₄	B	1137	29	40
12.5	YHJ150A4S0M0000	15.3/10.8	154,000	50 ⁷ / ₈ x 63 ¹ / ₈ x 99 ⁵ / ₈	C	1512	33	45
15	YHJ180A4S0M0000	17.5/11.9	185,000	59 x 87 x 123	D	2220	41	50
17.5	YHJ210A4S0M0000	15.7/11.6	215,000	59 x 87 x 123	D	2250	49	60
20	YHJ240A4S0M0000	16.3/10.8	247,000	59 x 87 x 123	D	2320	54	70
25	YHJ300A4S0M0000	15.6/10.6	282,000	59 x 87 x 123	D	2370	59	80
YHJ – 575/3/60 – Three Phase - Medium Heat								
6	YHJ072AWS0M0000	15.9/12.1	73,000	50 ⁷ / ₈ x 53 ¹ / ₄ x 88 ¹ / ₄	B	1107	15	15
7.5	YHJ090AWS0M0000	16.6/12.1	91,000	50 ⁷ / ₈ x 53 ¹ / ₄ x 88 ¹ / ₄	B	1111	17	20
8.5	YHJ102AWS0M0000	16.6/12.1	104,000	50 ⁷ / ₈ x 53 ¹ / ₄ x 88 ¹ / ₄	B	1127	19	25
10	YHJ120AWS0M0000	15.1/11.4	123,000	50 ⁷ / ₈ x 53 ¹ / ₄ x 88 ¹ / ₄	B	1137	22	30
12.5	YHJ150AWS0M0000	15.3/10.8	154,000	50 ⁷ / ₈ x 63 ¹ / ₈ x 99 ⁵ / ₈	C	1512	26	35
15	YHJ180AWS0M0000	17.5/11.9	185,000	59 x 87 x 123	D	2220	32	40
17.5	YHJ210AWS0M0000	15.7/11.6	215,000	59 x 87 x 123	D	2250	37	50
20	YHJ240AWS0M0000	16.3/10.8	247,000	59 x 87 x 123	D	2320	47	60
25	YHJ300AWS0M0000	15.6/10.6	282,000	59 x 87 x 123	D	2370	46	60

** Information subject to change. Please confirm with current product catalog Or IOM for current factory production.

For complete equipment / combination selections, installation instructions and warranty information, please refer to Product Data/Ratings and/or Installers Guides and Limited Warranty Handbooks.



It's Hard To Stop A Trane.®

Precedent™ Packaged Gas/Electric with Symbio™ Convertible 6 - 25 Tons, High Efficiency, R-410A

Table LPG-12-A – Base Unit— High Efficiency – R-410A – Symbio

Tons	Unit Ordering No.	Performance IEER(2-speed)/EER	Net Cooling Capacity (Btuh)	Cabinet Dimensions (in.) H x W x L	Cabinet	Shipping Weight (lbs.)	MCA**	Max Fuse**
YHJ – 208-230/3/60 – Three Phase - High Heat								
6	YHJ072A3S0H0000	15.9/12.1	73,000	50 ⁷ / ₈ x 53 ¹ / ₄ x 88 ¹ / ₄	B	1107	38	50
7.5	YHJ090A3S0H0000	16.6/12.1	91,000	50 ⁷ / ₈ x 53 ¹ / ₄ x 88 ¹ / ₄	B	1111	42	50
8.5	YHJ102A3S0H0000	16.6/12.1	104,000	50 ⁷ / ₈ x 53 ¹ / ₄ x 88 ¹ / ₄	B	1127	48	60
10	YHJ120A3S0H0000	15.1/11.4	123,000	50 ⁷ / ₈ x 53 ¹ / ₄ x 88 ¹ / ₄	B	1137	54	70
12.5	YHJ150A3S0H0000	15.3/10.8	154,000	50 ⁷ / ₈ x 63 ¹ / ₈ x 99 ⁵ / ₈	C	1512	64	90
15	YHJ180A3S0H0000	17.5/11.9	185,000	59 x 87 x 123	D	2220	78	100
17.5	YHJ210A3S0H0000	15.7/11.6	215,000	59 x 87 x 123	D	2250	93	110
20	YHJ240A3S0H0000	16.3/10.8	247,000	59 x 87 x 123	D	2320	108	125
25	YHJ300A3S0H0000	15.6/10.6	282,000	59 x 87 x 123	D	2370	119	150
YHJ – 460/3/60 – Three Phase - High Heat								
6	YHJ072A4S0H0000	15.9/12.1	73,000	50 ⁷ / ₈ x 53 ¹ / ₄ x 88 ¹ / ₄	B	1107	18	20
7.5	YHJ090A4S0H0000	16.6/12.1	91,000	50 ⁷ / ₈ x 53 ¹ / ₄ x 88 ¹ / ₄	B	1111	21	25
8.5	YHJ102A4S0H0000	16.6/12.1	104,000	50 ⁷ / ₈ x 53 ¹ / ₄ x 88 ¹ / ₄	B	1127	25	30
10	YHJ120A4S0H0000	15.1/11.4	123,000	50 ⁷ / ₈ x 53 ¹ / ₄ x 88 ¹ / ₄	B	1137	29	40
12.5	YHJ150A4S0H0000	15.3/10.8	154,000	50 ⁷ / ₈ x 63 ¹ / ₈ x 99 ⁵ / ₈	C	1512	33	45
15	YHJ180A4S0H0000	17.5/11.9	185,000	59 x 87 x 123	D	2220	41	50
17.5	YHJ210A4S0H0000	15.7/11.6	215,000	59 x 87 x 123	D	2250	49	60
20	YHJ240A4S0H0000	16.3/10.8	247,000	59 x 87 x 123	D	2320	54	70
25	YHJ300A4S0H0000	15.6/10.6	282,000	59 x 87 x 123	D	2370	59	80
YHJ – 575/3/60 – Three Phase - High Heat								
6	YHJ072AWS0H0000	15.9/12.1	73,000	50 ⁷ / ₈ x 53 ¹ / ₄ x 88 ¹ / ₄	B	1107	15	15
7.5	YHJ090AWS0H0000	16.6/12.1	91,000	50 ⁷ / ₈ x 53 ¹ / ₄ x 88 ¹ / ₄	B	1111	17	20
8.5	YHJ102AWS0H0000	16.6/12.1	104,000	50 ⁷ / ₈ x 53 ¹ / ₄ x 88 ¹ / ₄	B	1127	19	25
10	YHJ120AWS0H0000	15.1/11.4	123,000	50 ⁷ / ₈ x 53 ¹ / ₄ x 88 ¹ / ₄	B	1137	22	30
12.5	YHJ150AWS0H0000	15.3/10.8	154,000	50 ⁷ / ₈ x 63 ¹ / ₈ x 99 ⁵ / ₈	C	1512	26	35
15	YHJ180AWS0H0000	17.5/11.9	185,000	59 x 87 x 123	D	2220	32	40
17.5	YHJ210AWS0H0000	15.7/11.6	215,000	59 x 87 x 123	D	2250	37	50
20	YHJ240AWS0H0000	16.3/10.8	247,000	59 x 87 x 123	D	2320	47	60
25	YHJ300AWS0H0000	15.6/10.6	282,000	59 x 87 x 123	D	2370	46	60

** Information subject to change. Please confirm with current product catalog Or IOM for current factory production.

Light Commercial
Packaged Gas/Electric

ONLINE



It's Hard To Stop A Trane.®

Precedent™ Packaged Gas/Electric with Symbio™ Convertible 6 - 25 Tons, R-410A

Light Commercial
Packaged Gas/Electric

Table LPG-13-A – Base Unit – Standard Efficiency – R-410A – Symbio

Tons	Unit Ordering No.	Performance IEER(2-speed)/EER	Net Cooling Capacity (Btuh)	Cabinet Dimensions (in.) H x W x L	Cabinet	Shipping Weight (lbs.)	MCA**	Max Fuse**
YSJ – 208-230/3/60 – Three Phase - Low Heat								
6	YSJ072A3S0L0000	14.6/11.0	72,000	50 ⁷ / ₈ x 53 ¹ / ₄ x 88 ¹ / ₄	B	1107	38	50
7.5	YSJ090A3S0L0000	14.6/11.0	90,000	50 ⁷ / ₈ x 53 ¹ / ₄ x 88 ¹ / ₄	B	1111	42	50
8.5	YSJ102A3S0L0000	14.6/11.0	102,000	50 ⁷ / ₈ x 53 ¹ / ₄ x 88 ¹ / ₄	B	1127	48	60
10	YSJ120A3S0L0000	14.6/11.0	120,000	50 ⁷ / ₈ x 53 ¹ / ₄ x 88 ¹ / ₄	B	1137	54	70
12.5	YSJ150A3S0L0000	14.0/10.8	148,000	50 ⁷ / ₈ x 63 ¹ / ₈ x 99 ⁵ / ₈	C	1512	64	90
15	YSJ180A3S0L0000	14.0/10.8	182,000	59 x 87 x 123	D	2220	78	100
17.5	YSJ210A3S0L0000	14.0/10.8	210,000	59 x 87 x 123	D	2250	93	110
20	YSJ240A3S0L0000	13.0/9.8	240,000	59 x 87 x 123	D	2320	108	125
25	YSJ300A3S0L0000	13.0/9.8	271,000	59 x 87 x 123	D	2370	119	150
YSJ – 460/3/60 – Three Phase - Low Heat								
6	YSJ072A4S0L0000	14.6/11.0	72,000	50 ⁷ / ₈ x 53 ¹ / ₄ x 88 ¹ / ₄	B	1107	18	20
7.5	YSJ090A4S0L0000	14.6/11.0	90,000	50 ⁷ / ₈ x 53 ¹ / ₄ x 88 ¹ / ₄	B	1111	21	25
8.5	YSJ102A4S0L0000	14.6/11.0	102,000	50 ⁷ / ₈ x 53 ¹ / ₄ x 88 ¹ / ₄	B	1127	25	30
10	YSJ120A4S0L0000	14.6/11.0	120,000	50 ⁷ / ₈ x 53 ¹ / ₄ x 88 ¹ / ₄	B	1137	29	40
12.5	YSJ150A4S0L0000	14.0/10.8	148,000	50 ⁷ / ₈ x 63 ¹ / ₈ x 99 ⁵ / ₈	C	1512	33	45
15	YSJ180A4S0L0000	14.0/10.8	182,000	59 x 87 x 123	D	2220	41	50
17.5	YSJ210A4S0L0000	14.0/10.8	210,000	59 x 87 x 123	D	2250	49	60
20	YSJ240A4S0L0000	13.0/9.8	240,000	59 x 87 x 123	D	2320	54	70
25	YSJ300A4S0L0000	13.0/9.8	271,000	59 x 87 x 123	D	2370	59	80
YSJ – 575/3/60 – Three Phase - Low Heat								
6	YSJ072AWS0L0000	14.6/11.0	72,000	50 ⁷ / ₈ x 53 ¹ / ₄ x 88 ¹ / ₄	B	1107	15	15
7.5	YSJ090AWS0L0000	14.6/11.0	90,000	50 ⁷ / ₈ x 53 ¹ / ₄ x 88 ¹ / ₄	B	1111	17	20
8.5	YSJ102AWS0L0000	14.6/11.0	102,000	50 ⁷ / ₈ x 53 ¹ / ₄ x 88 ¹ / ₄	B	1127	19	25
10	YSJ120AWS0L0000	14.6/11.0	120,000	50 ⁷ / ₈ x 53 ¹ / ₄ x 88 ¹ / ₄	B	1137	22	30
12.5	YSJ150AWS0L0000	14.0/10.8	148,000	50 ⁷ / ₈ x 63 ¹ / ₈ x 99 ⁵ / ₈	C	1512	26	35
15	YSJ180AWS0L0000	14.0/10.8	182,000	59 x 87 x 123	D	2220	32	40
17.5	YSJ210AWS0L0000	14.0/10.8	210,000	59 x 87 x 123	D	2250	37	50
20	YSJ240AWS0L0000	13.0/9.8	240,000	59 x 87 x 123	D	2320	47	60
25	YSJ300AWS0L0000	13.0/9.8	271,000	59 x 87 x 123	D	2370	46	60
YSJ – 208-230/3/60 – Three Phase - Medium Heat								
6	YSJ072A3S0M0000	14.6/11.0	72,000	50 ⁷ / ₈ x 53 ¹ / ₄ x 88 ¹ / ₄	B	1107	38	50
7.5	YSJ090A3S0M0000	14.6/11.0	90,000	50 ⁷ / ₈ x 53 ¹ / ₄ x 88 ¹ / ₄	B	1111	42	50
8.5	YSJ102A3S0M0000	14.6/11.0	102,000	50 ⁷ / ₈ x 53 ¹ / ₄ x 88 ¹ / ₄	B	1127	48	60
10	YSJ120A3S0M0000	14.6/11.0	120,000	50 ⁷ / ₈ x 53 ¹ / ₄ x 88 ¹ / ₄	B	1137	54	70
12.5	YSJ150A3S0M0000	14.0/10.8	148,000	50 ⁷ / ₈ x 63 ¹ / ₈ x 99 ⁵ / ₈	C	1512	64	90
15	YSJ180A3S0M0000	14.0/10.8	182,000	59 x 87 x 123	D	2220	78	100
17.5	YSJ210A3S0M0000	14.0/10.8	210,000	59 x 87 x 123	D	2250	93	110
20	YSJ240A3S0M0000	13.0/9.8	240,000	59 x 87 x 123	D	2320	108	125
25	YSJ300A3S0M0000	13.0/9.8	271,000	59 x 87 x 123	D	2370	119	150
YSJ – 460/3/60 – Three Phase - Medium Heat								
6	YSJ072A4S0M0000	14.6/11.0	72,000	50 ⁷ / ₈ x 53 ¹ / ₄ x 88 ¹ / ₄	B	1107	18	20
7.5	YSJ090A4S0M0000	14.6/11.0	90,000	50 ⁷ / ₈ x 53 ¹ / ₄ x 88 ¹ / ₄	B	1111	21	25
8.5	YSJ102A4S0M0000	14.6/11.0	102,000	50 ⁷ / ₈ x 53 ¹ / ₄ x 88 ¹ / ₄	B	1127	25	30
10	YSJ120A4S0M0000	14.6/11.0	120,000	50 ⁷ / ₈ x 53 ¹ / ₄ x 88 ¹ / ₄	B	1137	29	40
12.5	YSJ150A4S0M0000	14.0/10.8	148,000	50 ⁷ / ₈ x 63 ¹ / ₈ x 99 ⁵ / ₈	C	1512	33	45
15	YSJ180A4S0M0000	14.0/10.8	182,000	59 x 87 x 123	D	2220	41	50
17.5	YSJ210A4S0M0000	14.0/10.8	210,000	59 x 87 x 123	D	2250	49	60
20	YSJ240A4S0M0000	13.0/9.8	240,000	59 x 87 x 123	D	2320	54	70
25	YSJ300A4S0M0000	13.0/9.8	271,000	59 x 87 x 123	D	2370	59	80
YSJ – 575/3/60 – Three Phase - Medium Heat								
6	YSJ072AWS0M0000	14.6/11.0	72,000	50 ⁷ / ₈ x 53 ¹ / ₄ x 88 ¹ / ₄	B	1107	15	15
7.5	YSJ090AWS0M0000	14.6/11.0	90,000	50 ⁷ / ₈ x 53 ¹ / ₄ x 88 ¹ / ₄	B	1111	17	20
8.5	YSJ102AWS0M0000	14.6/11.0	102,000	50 ⁷ / ₈ x 53 ¹ / ₄ x 88 ¹ / ₄	B	1127	19	25
10	YSJ120AWS0M0000	14.6/11.0	120,000	50 ⁷ / ₈ x 53 ¹ / ₄ x 88 ¹ / ₄	B	1137	22	30
12.5	YSJ150AWS0M0000	14.0/10.8	148,000	50 ⁷ / ₈ x 63 ¹ / ₈ x 99 ⁵ / ₈	C	1512	26	35
15	YSJ180AWS0M0000	14.0/10.8	182,000	59 x 87 x 123	D	2220	32	40
17.5	YSJ210AWS0M0000	14.0/10.8	210,000	59 x 87 x 123	D	2250	37	50
20	YSJ240AWS0M0000	13.0/9.8	240,000	59 x 87 x 123	D	2320	47	60
25	YSJ300AWS0M0000	13.0/9.8	271,000	59 x 87 x 123	D	2370	46	60

** Information subject to change. Please confirm with current product catalog Or IOM for current factory production.

For complete equipment / combination selections, installation instructions and warranty information, please refer to Product Data/Ratings and/or Installers Guides and Limited Warranty Handbooks.



It's Hard To Stop A Trane.®

Precedent™ Packaged Gas/Electric with Symbio™ Convertible 6 - 25 Tons, R-410A

Table LPG-14-A – Base Unit – Standard Efficiency – R-410A – Symbio

Tons	Unit Ordering No.	Performance IEER(2-speed)/EER	Net Cooling Capacity (Btuh)	Cabinet Dimensions (in.) H x W x L	Cabinet	Shipping Weight (lbs.)	MCA**	Max Fuse**
YSJ – 208-230/3/60 – Three Phase - High Heat								
6	YSJ072A3S0H0000	14.6/11.0	72,000	50 ⁷ / ₈ x 53 ¹ / ₄ x 88 ¹ / ₄	B	1107	38	50
7.5	YSJ090A3S0H0000	14.6/11.0	90,000	50 ⁷ / ₈ x 53 ¹ / ₄ x 88 ¹ / ₄	B	1111	42	50
8.5	YSJ102A3S0H0000	14.6/11.0	102,000	50 ⁷ / ₈ x 53 ¹ / ₄ x 88 ¹ / ₄	B	1127	48	60
10	YSJ120A3S0H0000	14.6/11.0	120,000	50 ⁷ / ₈ x 53 ¹ / ₄ x 88 ¹ / ₄	B	1137	54	70
12.5	YSJ150A3S0H0000	14.0/10.8	148,000	50 ⁷ / ₈ x 63 ¹ / ₈ x 99 ⁵ / ₈	C	1512	64	90
15	YSJ180A3S0H0000	14.0/10.8	182,000	59 x 87 x 123	D	2220	78	100
17.5	YSJ210A3S0H0000	14.0/10.8	210,000	59 x 87 x 123	D	2250	93	110
20	YSJ240A3S0H0000	13.0/9.8	240,000	59 x 87 x 123	D	2320	108	125
25	YSJ300A3S0H0000	13.0/9.8	271,000	59 x 87 x 123	D	2370	119	150
YSJ – 460/3/60 – Three Phase - High Heat								
6	YSJ072A4S0H0000	14.6/11.0	72,000	50 ⁷ / ₈ x 53 ¹ / ₄ x 88 ¹ / ₄	B	1107	18	20
7.5	YSJ090A4S0H0000	14.6/11.0	90,000	50 ⁷ / ₈ x 53 ¹ / ₄ x 88 ¹ / ₄	B	1111	21	25
8.5	YSJ102A4S0H0000	14.6/11.0	102,000	50 ⁷ / ₈ x 53 ¹ / ₄ x 88 ¹ / ₄	B	1127	25	30
10	YSJ120A4S0H0000	14.6/11.0	120,000	50 ⁷ / ₈ x 53 ¹ / ₄ x 88 ¹ / ₄	B	1137	29	40
12.5	YSJ150A4S0H0000	14.0/10.8	148,000	50 ⁷ / ₈ x 63 ¹ / ₈ x 99 ⁵ / ₈	C	1512	33	45
15	YSJ180A4S0H0000	14.0/10.8	182,000	59 x 87 x 123	D	2220	41	50
17.5	YSJ210A4S0H0000	14.0/10.8	210,000	59 x 87 x 123	D	2250	49	60
20	YSJ240A4S0H0000	13.0/9.8	240,000	59 x 87 x 123	D	2320	54	70
25	YSJ300A4S0H0000	13.0/9.8	271,000	59 x 87 x 123	D	2370	59	80
YSJ – 575/3/60 – Three Phase - High Heat								
6	YSJ072AWS0H0000	14.6/11.0	72,000	50 ⁷ / ₈ x 53 ¹ / ₄ x 88 ¹ / ₄	B	1107	15	15
7.5	YSJ090AWS0H0000	14.6/11.0	90,000	50 ⁷ / ₈ x 53 ¹ / ₄ x 88 ¹ / ₄	B	1111	17	20
8.5	YSJ102AWS0H0000	14.6/11.0	102,000	50 ⁷ / ₈ x 53 ¹ / ₄ x 88 ¹ / ₄	B	1127	19	25
10	YSJ120AWS0H0000	14.6/11.0	120,000	50 ⁷ / ₈ x 53 ¹ / ₄ x 88 ¹ / ₄	B	1137	22	30
12.5	YSJ150AWS0H0000	14.0/10.8	148,000	50 ⁷ / ₈ x 63 ¹ / ₈ x 99 ⁵ / ₈	C	1512	26	35
15	YSJ180AWS0H0000	14.0/10.8	182,000	59 x 87 x 123	D	2220	32	40
17.5	YSJ210AWS0H0000	14.0/10.8	210,000	59 x 87 x 123	D	2250	37	50
20	YSJ240AWS0H0000	13.0/9.8	240,000	59 x 87 x 123	D	2320	47	60
25	YSJ300AWS0H0000	13.0/9.8	271,000	59 x 87 x 123	D	2370	46	60

** Information subject to change. Please confirm with current product catalog Or IOM for current factory production.

Light Commercial
Packaged Gas/Electric

ONLINE



It's Hard To Stop A Trane.®

Precedent™ Packaged Gas/Electric with Symbio™ Convertible 6 - 25 Tons, R-410A (Model Digit Numbers)

Light Commercial
Packaged Gas/Electric

Digit	Description	Order Number	Digit	Description	Order Number
1	Unit Function		16	Hinged Service Access & Filters	
	DX Cooling.....	Y		Standard Panels/Standard Filters.....	0
2	Cooling Efficiency			Hinged Access Panels/Standard Filters.....	A
	Standard Efficiency.....	S		Standard Panels/2" MERV 8 Filters.....	B
	High Efficiency.....	H		Hinged Access Panels/2" MERV 8 Filters.....	C
3	Refrigerant			Standard Panels/2" MERV 13 Filters.....	D
	R-410A.....	J		Hinged Access Panels/2" MERV 13 Filters.....	E
4,5,6	Nominal Gross Cooling Capacity (MBh)		17	Condenser Coil Protection	
	6 Ton.....	072		Standard Coil.....	0
	7.5 Ton.....	090		Condenser with CompleteCoat™.....	1
	8.5 Ton.....	102	18	Through the Base Provisions	
	10 Ton.....	120		No Through-the-Base-Provisions.....	0
	12.5 Ton.....	150		Through-the-Base Electric.....	A
	15 Ton.....	180		<i>Note: Applicable to Digit 1, Y models only.</i>	
	17.5 Ton.....	210		Through-the-Base Gas Pipingⓐ.....	B
	20 Ton.....	240		Through-the-Base Electric and Gas Pipingⓐ.....	C
	25 Ton.....	300	19	Disconnect/Circuit Breaker (3 phase only)	
7	Design Sequence	*		No Disconnect/Circuit Breaker.....	0
				Unit Mounted/Non-Fused Disconnect.....	1
8	Voltage			Unit Mounted Circuit Breaker.....	2
	208-230/60/3.....	3	20	Convenience Outlet	
	460/60/3.....	4		No Convenience Outlet.....	0
	575/60/3.....	W		Unpowered 20A Convenience Outlet.....	A
9	Unit Controls			Powered 15A Convenience Outlet (3 phase only).....	B
	Symbio 700.....	S	21	Communications Options	
10	Heat Type			No Communications Interface.....	0
	Base Model.....	0		Advanced Controller with BACnet® Communications Interface.....	1
	Stainless Steel Gas Heat.....	A		Advanced Controller with LonTalk® Communications Interface.....	2
	Modulating Gas Heat.....	B		Advanced Controller with Air-Fi® Communications Interface.....	3
11	Heating Capacityⓐ		22	Refrigeration System Option	
	Low Gas Heat.....	L		Standard Refrigeration System.....	0
	Medium Gas Heat.....	M		Dehumidification Option ①②.....	A
	High Gas Heat.....	H	23	Controls Expansion Module	
12-13	Service Sequence			None.....	0
	Factory Supplied.....	*,*		XM-30 Expansion Module.....	1
14	Fresh Air Selection			XM-32 Expansion Module.....	2
	No Fresh Air.....	0		XM-30 and XM-32 Expansion Module.....	3
	Manual Outside Air Damper 0-50%.....	A		XM-30 Expansion Module (Qty 2).....	4
	Motorized Outside Air Damper 0-50%.....	B		XM-32 Expansion Module (Qty 2).....	5
	Economizer, Dry Bulb 0-100% without Barometric Reliefⓐ.....	C	24	Smoke Detector	
	Economizer, Dry Bulb 0-100% with Barometric Reliefⓐ.....	D		No Smoke Detector.....	0
	Economizer, Reference Enthalpy 0-100% without Barometric Reliefⓐ.....	E		Return Air Smoke Detectorⓐ.....	A
	Economizer, Reference Enthalpy 0-100% with Barometric Reliefⓐ.....	F		Supply Air Smoke Detectorⓐ.....	B
	Economizer, Comparative Enthalpy 0-100% without Barometric Reliefⓐ.....	G		Supply and Return Air Smoke Detectors ①②.....	C
	Economizer, Comparative Enthalpy 0-100% with Barometric Reliefⓐ.....	H	25	System Monitoring Controls	
	Downflow Low Leak Economizer, Dry Bulb with Barometric Reliefⓐ.....	K		No Monitoring Control.....	0
	Downflow Low Leak Economizer, Reference Enthalpy with Barometric Reliefⓐ.....	M		Clogged Filter Switchⓐ.....	1
	Downflow Low Leak Economizer, Comparative Enthalpy with Barometric Reliefⓐ.....	P		Condensate Overflow Switchⓐ.....	2
	Downflow Low Leak Economizer, Differential Dry Bulb with Barometric Reliefⓐ.....	R		Discharge Air Sensing Tube.....	3
15	Supply Fan/Drive Type/Motor			Clogged Filter Switch and Condensate Overflow Switchⓐ②.....	4
	Standard Drive.....	0		Clogged Filter Switch and Discharge Air Sensing Tubeⓐ.....	5
	Optional Oversized/High Static Motor.....	1		Condensate Overflow Switch and Discharge Air Sensing Tubeⓐ.....	6
	Single Zone Variable Air Volume (SZVAV) with Standard Motor.....	2		Clogged Filter Switch, Condensate Overflow Switch and Discharge Air Sensing Tubeⓐ②.....	7
	Single Zone Variable Air Volume (SZVAV) with Oversized/High Static Motor.....	3	26	Not Used	
	Multiple Zone Variable Air Volume (MZVAV) with Standard Motor.....	4			0
	Multiple Zone Variable Air Volume (MZVAV) with Oversized/High Static Motor.....	5	27	Hardware Enhancements	
				No Enhancements.....	0
				Stainless Steel Drain Pan.....	1
			28	Short Circuit Current Rating	
				Standard (5k) SCCR Marking.....	0
				Tier 2 (=65K) SCCR Marking.....	A
			29	Low Ambientⓐ	
				None.....	0
				Low Ambient Cooling to 0°F.....	A

ⓐ Includes Symbio Indoor Module.
 ⓑ Includes Symbio Fresh Air Module.
 ⓒ Includes Symbio Customer Connection Module.
 ⓓ Standard Low Ambient Cooling Limit is 40°F.



It's Hard To Stop A Trane.®

Precedent™ Packaged Gas/Electric with Symbio Convertible 6-25 Tons, R-410A Accessories

Table LPG-16-A – Accessories

Model Number	Description	Used With Cabinets	Used With
FIABARM002*	Barometric Relief	B/C	YSJ/YHJ072A-150A
FIABARM003*	Barometric Relief	D	YSJ/YHJ180-300A
FIAC02K001*	CO2 (DCV) Wall Mounted Sensor	ALL	YSJ/YHJ072A-300A
FIAC02K002*	CO2 (DCV) Duct Mounted Sensor	ALL	YSJ/YHJ072A-300A
FIACURB402*	14-inch Full Perimeter Knockdown Curb	B	YSJ/YHJ072A-120A
FIACURB403*	14-inch Full Perimeter Knockdown Curb	C	YSJ/YHJ150A
FIACURB404*	14-inch Full Perimeter Knockdown Curb	D	YSJ/YHJ180A-300A
FIACLFS001*①	Clogged Filter Switch	B/C	YSJ/YHJ072A-150A
FIACLFS002*①	Clogged Filter Switch (MERV13)	B/C	YSJ/YHJ072A-150A
FIACLFS003*①	Clogged Filter Switch	D	YSJ/YHJ180A-300A
FIACLFS004*①	Clogged Filter Switch (MERV13)	D	YSJ/YHJ180A-300A
FIADAST003*	Discharge Air Sensing Tube Kit T/W Models	B	YSJ/YHJ072A-120A
FIADAST005*	Discharge Air Sensing Tube Kit T/W Models	C	YSJ/YHJ150A
FIADAST007*	Discharge Air Sensing Tube Kit Y Models (Digit 11 = L)	D	YSJ/YHJ180A-300A
FIADAST008*	Discharge Air Sensing Tube Kit T/W/Y Models (DIGIT 11= 0, M, H)	D	YSJ/YHJ072A-300A
FIADFB001*①	Differential Dry Bulb Economizer Control	ALL	YSJ/YHJ072A-300A
FIADMPR002*	Manual Damper	B/C	YSJ/YHJ072A-150A
FIADMPR003*	Manual Damper	D	YSJ/YHJ180A-300A
FIADMPR102*	Motorized Damper	B/C	YSJ/YHJ072A-150A
FIADMPR103*	Motorized Damper	D	YSJ/YHJ180A-300A
FIAECON002*①	Dry Bulb Economizer	B/C	YSJ/YHJ072A-150A
FIAECON102*①	Dry Bulb Downflow Low Leak	B/C	YSJ/YHJ072A-150A
FIAECON003*①	Dry Bulb Downflow Economizer	D	YSJ/YHJ180A-300A
FIAECON303*①	Dry Bulb Horizontal Economizer	D	YSJ/YHJ180A-300A
FIAECON103*①	Dry Bulb Downflow Low Leak	D	YSJ/YHJ180A-300A
FIAECON203*①	Dry Bulb Horizontal Low Leak	D	YSJ/YHJ180A-300A
FIAENTH001*	Reference Enthalpy Economizer Control	ALL	YSJ/YHJ072A-300A
FIAENTH002*	Comparative Enthalpy Economizer Control	ALL	YSJ/YHJ072A-300A
FIAHTST001*	High Temperature (Fire) Duct Mounted Stat	ALL	YSJ/YHJ072A-300A
FIAHZDC001*	Horizontal Conversion Panel	D	YSJ/YHJ180A-300A
FIALOAM001*	Low Ambient	ALL	YSJ/YHJ072A-300A
FIALTCI001*	LonTalk Communication Interface	ALL	YSJ/YHJ072A-300A
FIAOPTN001*	Indoor Options Module	ALL	YSJ/YHJ072A-300A
FIAOPTN002*	Fresh Air Options Module	ALL	YSJ/YHJ072A-300A
FIAOVFL001*②	Condensate Overflow Switch	ALL	YSJ/YHJ072A-300A
FIAPWRX302*	Power Exhaust 230V	B/C	YSJ/YHJ072A3-150A3
FIAPWRX402*	Power Exhaust 460V	B/C	YSJ/YHJ072A4-150A4
FIAPWRXW02*	Power Exhaust 575V	B/C	YSJ/YHJ072AW-150AW
FIAHALT002*	High Altitude Gas Adjustment Kit	B/C	YSJ/YHJ072-150
FIAHALT003*	High Altitude Gas Adjustment Kit	D	YSJ/YHJ180-300
FIALPKT002*	LP Gas Conversion Kit	B/C	YSJ/YHJ072-150
FIALPKT003*	LP Gas Conversion Kit	D	YSJ/YHJ180-300
FIAPWRX303*	Power Exhaust 230V	D	YSJ/YHJ180A3-300A3
FIAPWRX403*	Power Exhaust 460V	D	YSJ/YHJ180A4-300A4
FIAPWRXW03*	Power Exhaust 575V	D	YSJ/YHJ180AW-300AW
FIAQACB026*	Adapter Curb, Existing BAYCURB026 to New C Cabinet (FIACURB403A)	C	YSJ/YHJ150A
FIAQACB027*	Adapter Curb, Existing BAYCURB027 to New C Cabinet (BAYCURB403A)	C	YSJ/YHJ150A
FIAQACB044*	Adapter Curb, Existing BAYCURB044 to New B Cabinet (BAYCURB402A)	B	YSJ/YHJ072A-120A
FIASCCM001*③④	Symbio Customer Connection Module	ALL	YSJ/YHJ072A-300A
FIAXMOD030*④⑤	Symbio 700 XM30 Expansion Module	ALL	YSJ/YHJ072A-300A
FIAXMOD032*④⑤	Symbio 700 XM32 Expansion Module	ALL	YSJ/YHJ072A-300A

- ① Requires Symbio™ Indoor Options Module.
- ② Requires Symbio™ Fresh Air Options Module.
- ③ Provides Ventilation Override, External Auto/Stop, Alarm Indicator, Remote Min Position.
- ④ Requires Symbio™ Advanced Controller (digit 21=1 or 3).
- ⑤ Requires Tracer TU and Utilizes TGP2 Software (programming knowledge required).

* Parts designator subject to change

For complete equipment / combination selections, installation instructions and warranty information, please refer to Product Data/Ratings and/or Installers Guides and Limited Warranty Handbooks.



It's Hard To Stop A Trane.®

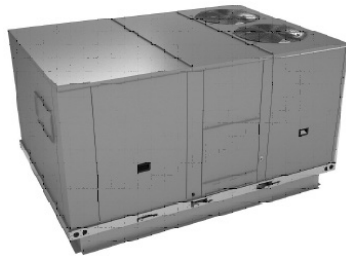

Foundation™ Packaged Gas/Electric 3-5 Tons, R-410A

- Scroll compressors on all units
- Operating Charge of R-410A
- Low ambient operation of 40°F as standard
- Color coded and numbered wiring
- Single side service access
- Provisions for through the base connections
- Phase monitor on all units
- Convertible airflow on all units
- Non-corrosive drain pan
- Separate high and low voltage areas in control box
- 5-year limited compressor and heat exchanger warranty

Table LPG-17-A — Foundation™ - R-410A - Electromechanical Controls

Tons	Unit Model No	Power Supply Volts/Phase/Hz	Performance SEER	Cooling Capacity (Btuh)	Heating Output Capacity (Btuh)	Dimensions (in.) H x W x L	Shipping Weight (lbs.)	MCA**	Max Fuse Size or Max Circuit Breaker**	Downflow Roofcurb①
GBC - Three Phase Low Heat										
3	GBC036A3ELB0000	208-230/3/60	14.0	36,000	57,600	42 ⁵ / ₈ x 48 x 76 ⁷ / ₈	574	19.5	25	BAYCURB320
4	GBC048A3ELB0000	208-230/3/60	14.0	48,000	57,600	42 ⁵ / ₈ x 48 x 76 ⁷ / ₈	616	23.6	35	BAYCURB320
5	GBC060A3ELB0000	208-230/3/60	14.0	57,500	57,600	42 ⁵ / ₈ x 48 x 76 ⁷ / ₈	636	26.4	40	BAYCURB320
3	GBC036A4ELB0000	460/3/60	14.0	36,000	57,600	42 ⁵ / ₈ x 48 x 76 ⁷ / ₈	574	10.5	15	BAYCURB320
4	GBC048A4ELB0000	460/3/60	14.0	48,000	57,600	42 ⁵ / ₈ x 48 x 76 ⁷ / ₈	616	11	15	BAYCURB320
5	GBC060A4ELB0000	460/3/60	14.0	57,500	57,600	42 ⁵ / ₈ x 48 x 76 ⁷ / ₈	636	12.9	20	BAYCURB320
3	GBC036AWELB0000	575/3/60	14.0	36,000	57,600	42 ⁵ / ₈ x 48 x 76 ⁷ / ₈	574	6.8	15	BAYCURB320
4	GBC048AWELB0000	575/3/60	14.0	48,000	57,600	42 ⁵ / ₈ x 48 x 76 ⁷ / ₈	616	8.1	15	BAYCURB320
5	GBC060AWELB0000	575/3/60	14.0	57,500	57,600	42 ⁵ / ₈ x 48 x 76 ⁷ / ₈	636	9.2	15	BAYCURB320
GBC - Three Phase Medium Heat										
3	GBC036A3EMB0000	208-230/3/60	14.0	36,000	80,000	42 ⁵ / ₈ x 48 x 76 ⁷ / ₈	574	19.5	25	BAYCURB320
4	GBC048A3EMB0000	208-230/3/60	14.0	48,000	92,000	42 ⁵ / ₈ x 48 x 76 ⁷ / ₈	616	23.6	35	BAYCURB320
5	GBC060A3EMB0000	208-230/3/60	14.0	57,500	92,000	42 ⁵ / ₈ x 48 x 76 ⁷ / ₈	636	26.4	40	BAYCURB320
3	GBC036A4EMB0000	460/3/60	14.0	36,000	80,000	42 ⁵ / ₈ x 48 x 76 ⁷ / ₈	574	10.5	15	BAYCURB320
4	GBC048A4EMB0000	460/3/60	14.0	48,000	92,000	42 ⁵ / ₈ x 48 x 76 ⁷ / ₈	616	11	15	BAYCURB320
5	GBC060A4EMB0000	460/3/60	14.0	57,500	92,000	42 ⁵ / ₈ x 48 x 76 ⁷ / ₈	636	12.9	20	BAYCURB320
3	GBC036AWEMB0000	575/3/60	14.0	36,000	80,000	42 ⁵ / ₈ x 48 x 76 ⁷ / ₈	574	6.8	15	BAYCURB320
4	GBC048AWEMB0000	575/3/60	14.0	48,000	92,000	42 ⁵ / ₈ x 48 x 76 ⁷ / ₈	616	8.1	15	BAYCURB320
5	GBC060AWEMB0000	575/3/60	14.0	57,500	92,000	42 ⁵ / ₈ x 48 x 76 ⁷ / ₈	636	9.2	15	BAYCURB320

① For Downflow units only.

** Information subject to change. Please confirm with current Product Data/Service Facts for current factory production.



It's Hard To Stop A Trane.®

Foundation™ Packaged Gas/Electric 3-5 Tons, R-410A (Model Digit Numbers)

Light Commercial
Packaged Gas/Electric

Digit	Description	Order Number	Digit	Description	Order Number
1	Unit Function		15	Supply Fan/Drive Type/Motor	
	Packaged Gas Electric	G		Multi-Speed Standard Motor.....	7
2	Efficiency			Multi-Speed Oversized Motor	9
	Generation B.....	B	16	Access	
	Generation C - DOE.....	C		Standard Fork Access	0
3	Airflow Configuration			Third Side Condenser Fork Access (15-25 Tons)	F
	Convertible.....	C	17	Condenser Coil Protection	
4,5,6	Nominal Gross Cooling Capacity (MBh)			Standard Coil	0
	3 Ton.....	.036		Condenser with CompleteCoat™	4
	4 Ton.....	.048	18	Through the Base Provisions	
	5 Ton.....	.060		No Through-the Base-Provisions	0
	15 Ton.....	.180		Through-the-Base Electric	A
	17.5 Ton.....	.210		Through the Base Gas①	B
	20 Ton.....	.240		Through the Base Electric/Gas	C
	25 Ton.....	.300	19	Disconnect/Circuit Breake (3 phase only)	
7	Design Sequence	*		No Disconnect/Circuit Breaker	0
				Unit Mounted/Non-Fused Disconnect②	1
8	Voltage		20-24	Not Used	
	208-230/60/3	3		No Convenience Outlet0000
	460/60/3	4	25	System Monitoring Controls	
	575/60/3	W		No Monitoring Controls	0
9	Unit Controls			Condensate Drain Pan Overflow Switch.....	A
	Electromechanical	E	26	System Monitoring Controls 2	
10	Heating Capacity			Economizer Fault Detection and Diagnostics (FDD)⑤	B
	Gas Heat -Low	L			
	Gas Heat - Medium.....	M			
	Gas Heat - High	H			
	Gas Heat - SS Ht Ex - Low	X			
	Gas Heat - SS Ht Ex - Medium.....	Y			
	Gas Heat - SS Ht Ex - High	Z			
11	Design Sequence	*			
12-13	Service Sequence	*,*			
14	Fresh Air Selection				
	No Fresh Air	0			
	Manual Outside Air Damper 0-25%	A			
	Motorized Outside Air Damper 0-50%.....	B			
	Economizer, Dry Bulb 0-100% without Barometric Relief.....	C			
	Economizer, Dry Bulb 0-100% with Barometric Relief③	D			
	Economizer, Reference Enthalpy 0-100% without Barometric Relief.....	E			
	Economizer, Reference Enthalpy 0-100% with Barometric Relief③	F			
	Economizer, Comparative Enthalpy 0-100% without Barometric Relief.....	G			
	"Economizer, Comparative Enthalpy 0-100% with Barometric Relief③	H			
	Downflow Low Leak Economizer, Dry Bulb without Barometric Relief.....	J			
	Downflow Low Leak Economizer, Reference Enthalpy without Barometric Relief.....	L			
	Downflow Low Leak Economizer, Comparative Enthalpy without Barometric Relief.....	N			

- ① Some field set up required
- ② Must be ordered through the base electrical option
- ③ All factory installed Options are Built-to-Order. Check order services for estimated production cycle
- ④ Factory installed economizers only available in downflow configuration
- ⑤ Fault Detection and Diagnostics (FDD) is available on Low Leak Economizers only



It's Hard To Stop A Trane.®

Foundation™ Packaged Gas/Electric 3-5 Ton Accessories

Light Commercial
Packaged Gas/Electric

Table LPG-19-A — Foundation™ - Field-Installed Accessories (FOR 3 - 5 TON FOUNDATION PACKAGED GAS UNITS - GBC - ONLY)

Model Number	Description	Used With
BAYCURB320A	Roof curb	All
BAYGARD320A	Tool-less Hail Guard	All
BAYHAKT320A	High Altitude Kit	All
BAYLPKT320A	LP Kit	All
BAYTBGF320A	Through the base - Gas	All
BAYTBUE320A	Through the base - Elec.	All
BAYDSCF322A	Unit Mounted Disconnect- cooling only, 100 Amp	All
BAYCO2K300A	Wall Mounted CO2 Sensor	All
BAYCO2K301A	Duct Mounted CO2 Sensor	All
BAYCOSW320A	Condensate Overflow Switch	All
BAYCCHT010B	Crankcase Heater – 208-230V (40 W) 6.5"	GBC048-060
BAYCCHT011B	Crankcase Heater - 460V/575V (40W) 6.5"	GBC048-060
BAYCCHT103A	Crankcase Heater – 208-230V (40 W) 5.5"	GBC036
BAYCCHT405A	Crankcase Heater - 460V/575V (40W) 5.5"	GBC036
BAYLOAM330A	Evaporator Defrost Control Kit	All
BAYLOAM340A	Low Ambient Kit	All
BAYASCT001	Compressor Short Cycle Timer	All
BAYHSMT320A	2 HP Oversize motor Kit (208-230/460V)	All
BAYHSMT322A	2 HP Oversize motor Kit (575V)	All
BAYDMPR321A	Manual Damper	All
BAYDMPR320A	Motorized Damper	All
BAYBARO320A	Barometric Relief Damper	All
BAYECON320A	Economizer, Dry Bulb, Downflow	All
BAYENTH320A	Reference Enthalpy Economizer Kit	All
BAYENTH321A	Comparative Enthalpy Economizer Kit	All
BAYECON353A ^①	Low Leak Economizer, Dry Bulb, Downflow W/FDD	All
BAYECON354A ^①	Low Leak Economizer, Dry Bulb, Horizontal W/FDD	All
BAYENTH323A ^①	Comparative Enthalpy Economizer Kit	All w/ Low Leak Economizer & FDD
BAYENTH322A ^①	Reference Enthalpy Economizer Kit	All w/ Low Leak Economizer & FDD
BAYBARO321A ^①	Barometric Relief Damper	All w/ Low Leak Economizer & FDD
BAYPWRX320A ^②	Power Exhasust DF, 208-230V	All
BAYPWRX321A ^②	Power Exhaust DF, 460V	All
BAYPWRX322A ^②	Power Exhasut DF, 575V	All

① FDD = Fault Detection & Diagnosis

② Please check availability

For complete equipment / combination selections, installation instructions and warranty information, please refer to Product Data/Ratings and/or Installers Guides and Limited Warranty Handbooks.



It's Hard To Stop A Trane.®

Medium Foundation™ Packaged Gas 7.5-12.5 Tons, R-410A



- Scroll compressors on all units
- Operating charge of R-410A
- Low ambient operation to 40°F as standard
- Color coded and numbered wiring
- Single side service access
- Molded handles on service access doors
- Separated high and low voltage compartments
- Liquid Line Refrigerant Drier
- Provisions for through the base connections
- Phase monitor on all units
- Convertible airflow
- Two inch throwaway filters as standard
- Non-corrosive & removable drain pan
- 5-year limited compressor warranty (7.5 - 12.5 tons)

Table LPG-20-A – Foundation™ – R-410A – Electromechanical Controls - 2-Speed Fan - Low Heat

Tons	Unit Model No.	Power Supply Volts/Phase/Hz	Performance (IEER)	Cooling Capacity (Btuh)	Heating Performance	Dimensions (in.) H x W x L	Shipping Weight (lbs.)	MCA	Max Fuse Size or Max Circuit Breaker [Ⓞ]	Downflow Roofcurb
7½	GCC090A3ELA3YXA	208-230/3/60				44 x 58¾ x 88¼	1080	37	50	BAYCURB310
8½	GCC102A3ELA3YXA	208-230/3/60				49⅞ x 58¾ x 88¼	1190	40	50	BAYCURB310
10	GCC120A3ELA3YXA	208-230/3/60				49⅞ x 58¾ x 88¼	1232	54	70	BAYCURB310
12½	GCC150A3ELA3YXA	208-230/3/60				49⅞ x 58¾ x 88¼	1334	62	80	BAYCURB310
7½	GCC090A4ELA3YXA	460/3/60				44 x 58¾ x 88¼	1080	22	25	BAYCURB310
8½	GCC102A4ELA3YXA	460/3/60				49⅞ x 58¾ x 88¼	1190	23	30	BAYCURB310
10	GCC120A4ELA3YXA	460/3/60				49⅞ x 58¾ x 88¼	1232	27	35	BAYCURB310
12½	GCC150A4ELA3YXA	460/3/60				49⅞ x 58¾ x 88¼	1334	31	40	BAYCURB310

Table LPG-20-B – Foundation™ – R-410A – Electromechanical Controls - 2-Speed Fan = Medium Heat

Tons	Unit Model No.	Power Supply Volts/Phase/Hz	Performance (IEER)	Cooling Capacity (Btuh)	Heating Performance	Dimensions (in.) H x W x L	Shipping Weight (lbs.)	MCA	Max Fuse Size or Max Circuit Breaker [Ⓞ]	Downflow Roofcurb
7½	GCC090A3EMA3YXA	208-230/3/60				44 x 58¾ x 88¼	1080	37	50	BAYCURB310
8½	GCC102A3EMA3YXA	208-230/3/60				49⅞ x 58¾ x 88¼	1190	40	50	BAYCURB310
10	GCC120A3EMA3YXA	208-230/3/60				49⅞ x 58¾ x 88¼	1232	54	70	BAYCURB310
12½	GCC150A3EMA3YXA	208-230/3/60				49⅞ x 58¾ x 88¼	1334	62	80	BAYCURB310
7½	GCC090A4EMA3YXA	460/3/60				44 x 58¾ x 88¼	1080	22	25	BAYCURB310
8½	GCC102A4EMA3YXA	460/3/60				49⅞ x 58¾ x 88¼	1190	23	30	BAYCURB310
10	GCC120A4EMA3YXA	460/3/60				49⅞ x 58¾ x 88¼	1232	27	35	BAYCURB310
12½	GCC150A4EMA3YXA	460/3/60				49⅞ x 58¾ x 88¼	1334	31	40	BAYCURB310

Table LPG-20-C – Foundation™ – R-410A – Electromechanical Controls - 2-Speed Fan - High Heat

Tons	Unit Model No.	Power Supply Volts/Phase/Hz	Performance (IEER)	Cooling Capacity (Btuh)	Heating Performance	Dimensions (in.) H x W x L	Shipping Weight (lbs.)	MCA	Max Fuse Size or Max Circuit Breaker [Ⓞ]	Downflow Roofcurb
7½	GCC090A3EHA3YXA	208-230/3/60				44 x 58¾ x 88¼	1080	22	25	BAYCURB310
8½	GCC102A3EHA3YXA	208-230/3/60				49⅞ x 58¾ x 88¼	1190	23	30	BAYCURB310
10	GCC120A3EHA3YXA	208-230/3/60				49⅞ x 58¾ x 88¼	1232	27	35	BAYCURB310
12½	GCC150A3EHA3YXA	208-230/3/60				49⅞ x 58¾ x 88¼	1334	31	40	BAYCURB310
7½	GCC090A4EHA3YXA	460/3/60				44 x 58¾ x 88¼	1080	22	25	BAYCURB310
8½	GCC102A4EHA3YXA	460/3/60				49⅞ x 58¾ x 88¼	1190	23	30	BAYCURB310
10	GCC120A4EHA3YXA	460/3/60				49⅞ x 58¾ x 88¼	1232	27	35	BAYCURB310
12½	GCC150A4EHA3YXA	460/3/60				49⅞ x 58¾ x 88¼	1334	31	40	BAYCURB310

Ⓞ HACR Circuit Breaker Type Per NEC.

3YXA medium Foundation models include multi-speed motor .

Information subject to change. Please confirm with current Product Data for current factory production.

For complete equipment / combination selections, installation instructions and warranty information, please refer to Product Data/Ratings and/or Installers Guides and Limited Warranty Handbooks.



It's Hard To Stop A Trane.®

Medium Foundation™ Packaged Gas 7.5-12.5 Tons, R-410A (Model Digit Numbers)

Light Commercial
Packaged Gas/Electric

Digit	Description	Order Number	Digit	Description	Order Number
1	Unit Function		11	Minor Design Sequence	
	Packaged Gas Electric	G			*
2	Efficiency		12-13	Service Sequence	
	Generation C - DOE	C			**
3	Airflow Configuration		14	Fresh Air Selection ③④	
	Convertible.....	C		No Fresh Air	0
4,5,6	Nominal Gross Cooling Capacity (MBh)		15	Supply Fan/Drive Type/Motor	
	7.5 Ton.....	090		Multi-Speed Standard Motor.....	7
	8.5 Ton.....	102		Multi-Speed Oversized Motor	9
	10 Ton.....	120	16	Unit Type	
	12.5 Ton.....	150		Medium Foundation.....	M
7	Design Sequence		17	Condenser Coil Protection	
		*		Standard Coil	0
8	Voltage		18	Through the Base Provisions	
	208-230/60/3	3		No Through-the Base-Provisions.....	0
	460/60/3	4	19	Disconnect/Circuit Breaker (3 phase only)	
9	Unit Controls			No Disconnect/Circuit Breaker	0
	Electromechanical	E	20-24	Not Used	
10	Heating Capacity			No Convenience Outlet	0000
	Gas Heat -Low	L	25	System Monitoring Controls1	
	Gas Heat - Medium.....	M		No Monitoring Controls	0
	Gas Heat - SS Ht Ex - Low	X	26	System Monitoring Controls 2	
	Gas Heat - SS Ht Ex - Medium.....	Y		Economizer Fault Detection and Diagnostics (FDD)⑤	B
	Gas Heat - SS Ht Ex - High	Z			

- ① Some field set up required
- ② Must be ordered through the base electrical option
- ③ All factory installed Options are Built-to-Order. Check order services for estimated production cycle
- ④ Factory installed economizers only available in downflow configuration
- ⑤ Fault Detection and Diagnostics (FDD) is available on Low Leak Economizers only

For complete equipment / combination selections, installation instructions and warranty information, please refer to Product Data/Ratings and/or Installers Guides and Limited Warranty Handbooks.



It's Hard To Stop A Trane.®

Medium Foundation™ Packaged Gas 7.5-12.5 Tons Accessories

Table LPG-22-A — Foundation™ - R-410A - Field Installed Accessories

Model Number	Description	Used With
BAYTBUE310.....	Through the Base Electrical Connections.....	AC Only Foundation 7.5 - 12.5 Ton Units
BAYDSCF300	Unit Mounted Disconnect, 100 Amp Not for use when electric heat installed	GCC090* - GCC150
BBAYDSCF302.....	Unit Mounted Disconnect, 100 Amp	BAYHTFA31BA, BAYHTFA41BA, BAYHTFAW1BA, BAYHTFA436A, BAYHTFA454A, BAYHTFBW36A, BAYHTFAW54A, BAYHTFBW54A, BAYHTFB454A
BAYDSCF303	Unit Mounted Disconnect, 150 Amp	BAYHTFA472A, BAYHTF4372A, BAYHTFA336A, BAYHTFB336A,
BAYDSCF304	Unit Mounted Disconnect, 250 Amp	BAYHTFA372A, BAYHTFB372A, BAYHTFA354A, BAYHTFAW36A
BAYDMPR311	Damper, Manual.....	GCC090A* - GCC150A*
BAYDMPR310.....	Damper, Motorized	GCC090A* - GCC150A*
BAYECON310	Economizer, Dry Bulb, Downflow	GCC090A* - GCC150A*
BAYECON311	Economizer, Dry Bulb, Horizontal	GCC090A* - GCC150A*
BAYECON355①.....	Low Leak Economizer w/FDD, Dry Bulb, Downflow	GCC090A* - GCC150A*
BAYECON356.....	Low Leak Economizer w/FDD, Dry Bulb, Horizontal	GCC090A* - GCC150A*
BAYBARO310	Barometric Relief Damper, 7.5 - 12.5 T	GCC090A* - GCC150A*
BAYENTH310.....	Reference Enthalpy Economizer Kit	GCC090A* - GCC150A*
BAYENTH311	Comparative Enthalpy Economizer Kit.....	GCC090A* - GCC150A*
BAYENTH312③.....	Reference Enthalpy Economizer Kit	GCC090A* - GCC150A* w/Low Leak Economizer & FDD
BAYENTH313③.....	Comparative Enthalpy Economizer Kit	GCC090A* - GCC150A* w/Low Leak Economizer & FDD
BAYCURB310	Roof Curb	GCC090A* - GCC150A*
BAYGARD310	Condenser Hail Guard.....	GCC090A
BAYGARD311	Condenser Hail Guard.....	GCC102A* - GCC150A*
BAYCCHT300	Crankcase Heater, 70W, 230V.....	GCC1B0A3* - GCC300A3*
BAYCCHT301	Crankcase Heater, 70W, 460V	GCC1B0A4* - GCC300A4*
BAYCCHT302	Crankcase Heater, 70W, 575V.....	GCC1B0AW* - GCC300AW*
BAYASCT001	Compressor Short Cycle Timer.....	GCC090A* - GCC150A*
BAYLOAM300.....	Low Ambient Control.....	GCC1B0A* - GCC300A*
BAYLOAM310	Evaporator Defrost Control.....	GCC1B0A* - GCC300A*
BAYPWRX310①.....	Power Exhaust, 15-25T, DF, 230V.....	GCC090A3* - GCC150A3*
BAYPWRX311①.....	Power Exhaust, 15-25T, DF, 460V.....	GCC090A4* - GCC150A4*
BAYPWRX312②.....	Power Exhaust, 15-25T, DF, 575V.....	GCC090AW* - GCC150AW*
BAYCO2K300	Wall Mounted CO2 Sensor.....	GCC090A* - GCC150A* with economizer
BAYCO2K301	Duct Mounted CO2 Sensor.....	GCC090A* - GCC150A* with economizer
BAYCOSW310	Drain Pan Overflow Switch	GCC090A* - GCC150A*
BAYSTAT300.....	BACNet Enabled Thermostat	GCC1B0A* - GCC300A*

① Please check availability.

② See HVAC Knowledge Center for a list of compatible Carrier units.

③ FDD = Fault Detection & Diagnostics.

Information subject to change. Please confirm with current Product Data for current factory production.

Light Commercial
Packaged Gas/Electric



It's Hard To Stop A Trane.®



Foundation™ Packaged Gas/Electric 15-25 Tons, R-410A

- Scroll compressors on all units
- Operating charge of R-410A
- Low ambient operation to 40°F as standard
- Color coded and numbered wiring
- Single side service access
- Molded handles on service access doors
- Liquid Line Refrigerant Drier
- Provisions for through the base connections
- Phase monitor on all units
- Convertible airflow with field installed kit on most models
- Two inch throwaway filters as standard
- Non-corrosive & removable drain pan
- Separated high and low voltage compartments
- 5-year limited compressor and heat exchanger warranty (15-25 tons)

Light Commercial
Packaged Gas/Electric

Table LPG-23-A — Foundation™ - R-410A - Electromechanical Controls - 2-Speed Indoor Fans

Tons	Unit Model No	Power Supply Volts/Phase/Hz	Performance EER/IEER	Cooling Capacity (Btuh)	Heating Output Capacity (Btuh)	Dimensions (in.) H x W x L	Shipping Weight (lbs.)	MCA**	Max Fuse Size or Max Circuit Breaker**	Downflow Roofcurb [Ⓛ]
GCC - Three Phase Low Heat										
15	GCC180A3ELA1DQY	208-230/3/60	11.0/14.2	194000	194400	58 ⁵ / ₈ x 86 ⁵ / ₁₆ x 123 ¹ / ₈	2310	75	100	BAYCURB027
17½	GCC210A3ELA1DQY	208-230/3/60	11.0/14.2	214000	194400	58 ⁵ / ₈ x 86 ⁵ / ₁₆ x 123 ¹ / ₈	2319	86	110	BAYCURB027
20	GCC240A3ELA1DQY	208-230/3/60	10.0/13.2	252000	194400	58 ⁵ / ₈ x 86 ⁵ / ₁₆ x 123 ¹ / ₈	2344	97	125	BAYCURB027
25	GCC300A3ELA1DQY	208-230/3/60	9.80/13.2	280000	194400	58 ⁵ / ₈ x 86 ⁵ / ₁₆ x 123 ¹ / ₈	2370	126	175	BAYCURB027
15	GCC180A4ELA1DQY	460/3/60	11.0/14.2	194000	194400	58 ⁵ / ₈ x 86 ⁵ / ₁₆ x 123 ¹ / ₈	2310	35	45	BAYCURB027
17½	GCC210A4ELA1DQY	460/3/60	11.0/14.2	214000	194400	58 ⁵ / ₈ x 86 ⁵ / ₁₆ x 123 ¹ / ₈	2319	42	50	BAYCURB027
20	GCC240A4ELA1DQY	460/3/60	10.0/13.2	252000	194400	58 ⁵ / ₈ x 86 ⁵ / ₁₆ x 123 ¹ / ₈	2344	46	60	BAYCURB027
25	GCC300A4ELA1DQY	460/3/60	9.80/13.2	280000	194400	58 ⁵ / ₈ x 86 ⁵ / ₁₆ x 123 ¹ / ₈	2370	53	70	BAYCURB027
15	GCC180AWELA1DQY	575/3/60	11.0/14.2	194000	194400	58 ⁵ / ₈ x 86 ⁵ / ₁₆ x 123 ¹ / ₈	2310	28	35	BAYCURB027
17½	GCC210AWELA1DQY	575/3/60	11.0/14.2	214000	194400	58 ⁵ / ₈ x 86 ⁵ / ₁₆ x 123 ¹ / ₈	2319	34	45	BAYCURB027
20	GCC240AWELA1DQY	575/3/60	10.0/13.2	252000	194400	58 ⁵ / ₈ x 86 ⁵ / ₁₆ x 123 ¹ / ₈	2344	38	50	BAYCURB027
25	GCC300AWELA1DQY	575/3/60	9.80/13.2	280000	194400	58 ⁵ / ₈ x 86 ⁵ / ₁₆ x 123 ¹ / ₈	2370	44	50	BAYCURB027
GCC - Three Phase Medium Heat										
15	GCC180A3EMA1DQY	208-230/3/60	11.0/14.2	194000	259200	58 ⁵ / ₈ x 86 ⁵ / ₁₆ x 123 ¹ / ₈	2310	75	100	BAYCURB027
17½	GCC210A3EMA1DQY	208-230/3/60	11.0/14.2	214000	259200	58 ⁵ / ₈ x 86 ⁵ / ₁₆ x 123 ¹ / ₈	2319	86	110	BAYCURB027
20	GCC240A3EMA1DQY	208-230/3/60	10.0/13.2	252000	259200	58 ⁵ / ₈ x 86 ⁵ / ₁₆ x 123 ¹ / ₈	2344	97	125	BAYCURB027
25	GCC300A3EMA1DQY	208-230/3/60	9.80/13.2	280000	259200	58 ⁵ / ₈ x 86 ⁵ / ₁₆ x 123 ¹ / ₈	2370	126	175	BAYCURB027
15	GCC180A4EMA1DQY	460/3/60	11.0/14.2	194000	259200	58 ⁵ / ₈ x 86 ⁵ / ₁₆ x 123 ¹ / ₈	2310	35	45	BAYCURB027
17½	GCC210A4EMA1DQY	460/3/60	11.0/14.2	214000	259200	58 ⁵ / ₈ x 86 ⁵ / ₁₆ x 123 ¹ / ₈	2319	42	50	BAYCURB027
20	GCC240A4EMA1DQY	460/3/60	10.0/13.2	252000	259200	58 ⁵ / ₈ x 86 ⁵ / ₁₆ x 123 ¹ / ₈	2344	46	60	BAYCURB027
25	GCC300A4EMA1DQY	460/3/60	9.80/13.2	280000	259200	58 ⁵ / ₈ x 86 ⁵ / ₁₆ x 123 ¹ / ₈	2370	53	70	BAYCURB027
15	GCC180AWEMA1DQY	575/3/60	11.0/14.2	194000	259200	58 ⁵ / ₈ x 86 ⁵ / ₁₆ x 123 ¹ / ₈	2310	28	35	BAYCURB027
17½	GCC210AWEMA1DQY	575/3/60	11.0/14.2	214000	259200	58 ⁵ / ₈ x 86 ⁵ / ₁₆ x 123 ¹ / ₈	2319	34	45	BAYCURB027
20	GCC240AWEMA1DQY	575/3/60	10.0/13.2	252000	259200	58 ⁵ / ₈ x 86 ⁵ / ₁₆ x 123 ¹ / ₈	2344	38	50	BAYCURB027
25	GCC300AWEMA1DQY	575/3/60	9.80/13.2	280000	259200	58 ⁵ / ₈ x 86 ⁵ / ₁₆ x 123 ¹ / ₈	2370	44	50	BAYCURB027
GCC - Three Phase High Heat[Ⓛ]										
15	GCC180A3EHA1DQY	208-230/3/60	11.0/14.2	194000	283500	58 ⁵ / ₈ x 86 ⁵ / ₁₆ x 123 ¹ / ₈	2310	75	100	BAYCURB027
17½	GCC210A3EHA1DQY	208-230/3/60	11.0/14.2	214000	307800/283500	58 ⁵ / ₈ x 86 ⁵ / ₁₆ x 123 ¹ / ₈	2319	86	110	BAYCURB027
20	GCC240A3EHA1DQY	208-230/3/60	10.0/13.2	252000	307800	58 ⁵ / ₈ x 86 ⁵ / ₁₆ x 123 ¹ / ₈	2344	97	125	BAYCURB027
25	GCC300A3EHA1DQY	208-230/3/60	9.80/13.2	280000	307800	58 ⁵ / ₈ x 86 ⁵ / ₁₆ x 123 ¹ / ₈	2370	126	175	BAYCURB027
15	GCC180A4EHA1DQY	460/3/60	11.0/14.2	194000	283500	58 ⁵ / ₈ x 86 ⁵ / ₁₆ x 123 ¹ / ₈	2310	35	45	BAYCURB027
17½	GCC210A4EHA1DQY	460/3/60	11.0/14.2	214000	307800/283500	58 ⁵ / ₈ x 86 ⁵ / ₁₆ x 123 ¹ / ₈	2319	42	50	BAYCURB027
20	GCC240A4EHA1DQY	460/3/60	10.0/13.2	252000	307800	58 ⁵ / ₈ x 86 ⁵ / ₁₆ x 123 ¹ / ₈	2344	46	60	BAYCURB027
25	GCC300A4EHA1DQY	460/3/60	9.80/13.2	280000	307800	58 ⁵ / ₈ x 86 ⁵ / ₁₆ x 123 ¹ / ₈	2370	53	70	BAYCURB027
15	GCC180AWEHA1DQY	575/3/60	11.0/14.2	194000	283500	58 ⁵ / ₈ x 86 ⁵ / ₁₆ x 123 ¹ / ₈	2310	28	35	BAYCURB027
17½	GCC210AWEHA1DQY	575/3/60	11.0/14.2	214000	307800/283500	58 ⁵ / ₈ x 86 ⁵ / ₁₆ x 123 ¹ / ₈	2319	34	45	BAYCURB027
20	GCC240AWEHA1DQY	575/3/60	10.0/13.2	252000	307800	58 ⁵ / ₈ x 86 ⁵ / ₁₆ x 123 ¹ / ₈	2344	38	50	BAYCURB027
25	GCC300AWEHA1DQY	575/3/60	9.80/13.2	280000	307800	58 ⁵ / ₈ x 86 ⁵ / ₁₆ x 123 ¹ / ₈	2370	44	50	BAYCURB027

Ⓛ HACR Circuit Breaker Type Per NEC.

1DQY models include a multi-speed motor.

Information subject to change. Please confirm with current Product Data for current factory production.

For complete equipment / combination selections, installation instructions and warranty information, please refer to Product Data/Ratings and/or Installers Guides and Limited Warranty Handbooks.



It's Hard To Stop A Trane.®

Foundation™ Packaged Gas/Electric 15-25 Tons, R-410A (Model Digit Numbers)

Light Commercial
Packaged Gas/Electric

Digit	Description	Order Number	Digit	Description	Order Number
1	Unit Function		15	Supply Fan/Drive Type/Motor	
	Packaged Gas Electric	G		Multi-Speed Standard Motor.....	7
2	Efficiency			Multi-Speed Oversized Motor	9
	Generation B.....	B	16	Access	
	Generation C - DOE.....	C		Standard Fork Access	0
3	Airflow Configuration			Third Side Condenser Fork Access (15-25 Tons)	F
	Convertible.....	C	17	Condenser Coil Protection	
4,5,6	Nominal Gross Cooling Capacity (MBh)			Standard Coil	0
	3 Ton.....	.036		Condenser with CompleteCoat™	4
	4 Ton.....	.048	18	Through the Base Provisions	
	5 Ton.....	.060		No Through-the-Base-Provisions	0
	15 Ton.....	.180		Through-the-Base Electric	A
	17.5 Ton.....	.210		Through the Base Gas①	B
	20 Ton.....	.240		Through the Base Electric/Gas	C
	25 Ton.....	.300	19	Disconnect/Circuit Breake (3 phase only)	
7	Design Sequence	*		No Disconnect/Circuit Breaker	0
				Unit Mounted/Non-Fused Disconnect②	1
8	Voltage		20-24	Not Used	
	208-230/60/3	3		No Convenience Outlet0000
	460/60/3	4	25	System Monitoring Controls	
	575/60/3	W		No Monitoring Controls	0
9	Unit Controls			Condensate Drain Pan Overflow Switch.....	A
	Electromechanical	E	26	System Monitoring Controls 2	
10	Heating Capacity			Economizer Fault Detection and Diagnostics (FDD)⑤	B
	Gas Heat -Low	L			
	Gas Heat - Medium.....	M			
	Gas Heat - High	H			
	Gas Heat - SS Ht Ex - Low	X			
	Gas Heat - SS Ht Ex - Medium.....	Y			
	Gas Heat - SS Ht Ex - High	Z			
11	Design Sequence	*			
12-13	Service Sequence	*,*			
14	Fresh Air Selection				
	No Fresh Air	0			
	Manual Outside Air Damper 0-25%	A			
	Motorized Outside Air Damper 0-50%.....	B			
	Economizer, Dry Bulb 0-100% without Barometric Relief.....	C			
	Economizer, Dry Bulb 0-100% with Barometric Relief①	D			
	Economizer, Reference Enthalpy 0-100% without Barometric Relief.....	E			
	Economizer, Reference Enthalpy 0-100% with Barometric Relief①	F			
	Economizer, Comparative Enthalpy 0-100% without Barometric Relief.....	G			
	"Economizer, Comparative Enthalpy 0-100% with Barometric Relief①	H			
	Downflow Low Leak Economizer, Dry Bulb without Barometric Relief.....	J			
	Downflow Low Leak Economizer, Reference Enthalpy without Barometric Relief.....	L			
	Downflow Low Leak Economizer, Comparative Enthalpy without Barometric Relief.....	N			

- ① Some field set up required
- ② Must be ordered through the base electrical option
- ③ All factory installed Options are Built-to-Order. Check order services for estimated production cycle
- ④ Factory installed economizers only available in downflow configuration
- ⑤ Fault Detection and Diagnostics (FDD) is available on Low Leak Economizers only



It's Hard To Stop A Trane.®

Foundation™ Packaged Gas/Electric 15-25 Tons Accessories

Light Commercial
Packaged Gas/Electric

Table LPG-25-A — Foundation™ - R-410A— Field-Installed Accessories (FOR 15 - 25 TON FOUNDATION PACKAGED GAS UNITS - GBC - ONLY)

Model Number	Description	Used With
BAYTBUE300A	Through the Base Electrical Connections	All Foundation 15-25 Ton Units
BAYDSCF300B	Unit Mounted Disconnect (460V & 575V)	GCC*180A4* - GCC*300A4*, GCC*180AW* - GCC*300AW*
BAYDSCF301B	Unit Mounted Disconnect (208-230V)	GCC*180A3* - GCC*300A3*
BAYTBGF300A	Through the Base Gas Connection, 400 MBH	GCC*180A* - GCC*300A*
BAYLPKT300A	Propane Conversion Kit	GCC*180A* - GCC*300A*
BAYHAKT300A	High Altitude Conversion Kit	GCC*180A* - GCC*300A*
BAYDMPR301A	Damper, Manual	GCC*180A* - GCC*300A*
BAYDMPR300A	Damper, Motorized	GCC*180A* - GCC*300A*
BAYECON300A	Economizer, Dry Bulb, Downflow	GCC*180A* - GCC*300A*
BAYECON301A	Economizer, Dry Bulb, Horizontal	GCC*180A* - GCC*300A*
BAYECON350B ^③	Low Leak Economizer w/FDD, Dry Bulb, Downflow	GCC*180A* - GCC*300A*
BAYECON351B	Low Leak Economizer w/FDD, Dry Bulb, Horizontal	GCC*180A* - GCC*300A*
BAYHZCN300A	Horizontal Economizer Conversion Kit	GCC*180A* - GCC*300A*
BAYBARO300A	Barometric Relief Damper, 15-25T	GCC*180A* - GCC*300A*
BAYENTH300A	Reference Enthalpy Economizer Kit	GCC*180A* - GCC*300A*
BAYENTH301A	Comparative Enthalpy Economizer Kit	GCC*180A* - GCC*300A*
BAYENTH302A ^③	Reference Enthalpy Economizer Kit	GCC*180A* - GCC*300A* w/Low Leak Economizer & FDD
BAYENTH303A ^③	Comparative Enthalpy Economizer Kit	GCC*180A* - GCC*300A* w/Low Leak Economizer & FDD
BAYCURB027B	Roof Curb	GCC*180A* - GCC*300A*
BAYHZRT001A	Horizontal Duct Conversion Kit	GCC*180A* - GCC*300A*
BAYCARR001A	Carrier Replacement Conversion Kit	GCC*180A* - GCC*300A*
BAYGARD300A	Condenser Hail Guard	GCC*180A* - GCC*300A*
BAYCCHT300A	Crankcase Heater, 70W, 208-230V	GCC*180A3 - GCC*300A3
BAYCCHT301A	Crankcase Heater, 70W, 460V	GCC*180A4 - GCC*300A4
BAYCCHT302A	Crankcase Heater, 70W, 575V	GCC*180AW - GCC*300AW
BAYASCT001	Compressor Short Cycle Timer	GCC*180A* - GCC*300A*
BAYLOAM301B	Low Ambient Control	GCC*180A* - GCC*300A*
BAYLOAM302B	Low Ambient Control	GCC*180A* - GCC*300A*
BAYLOAM310A	Evaporator Defrost Control	GCC*180A* - GCC*300A*
BAYPWRX300A ^①	Power Exhaust, 15-25T, DF, 208-230V	GCC*180A3 - GCC*300A3
BAYPWRX301A ^①	Power Exhaust, 15-25T, DF, 460V	GCC*180A4 - GCC*300A4
BAYPWRX302A ^①	Power Exhaust, 15-25T, DF, 575V	GCC*180AW - GCC*300AW
BAYHSMT300A	High Static Motor & Drv, 5HP 208-230/460V	GCC*180A* - GCC*300A*
BAYHSMT301A	High Static Motor & Drv, 5HP 575V	GCC*180AW
BAYHSMT302A	High Static Motor & Drv, 7.5HP 208-230V	GCC*210A3, GCC*240A3
BAYHSMT303A	High Static Motor & Drv, 7.5HP 460V	GCC*210A4, GCC*240A4
BAYHSMT304A	High Static Motor & Drv, 7.5HP 575V	GCC*210AW, GCC*240AW
BAYSHGR003A ^②	Shaft Grounding Ring, 0.875" Shaft	5HP VFD Motors
BAYSHGR002A ^②	Shaft Grounding Ring, 1.125" Shaft	7.5HP VFD Motors
BAYLSDR300A	Low Static Drive Option	GCC*180A* - GCC*300A*
BAYHSDR300A	High Static Drive Option	GCC*180A* - GCC*300A*
BAYCO2K300A	Wall Mounted CO2 Sensor	GCC*180A* - GCC*300A* with economizer
BAYCO2K301A	Duct Mounted CO2 Sensor	GCC*180A* - GCC*300A* with economizer
BAYCOSW300A	Drain Pan Overflow Switch	GCC*180A* - GCC*300A*
BAYSTAT300A	BACNet Enabled Thermostat	GCC*180A* - GCC*300A*
BAYPALT001A	Reuseable Pallet for Condenser End Unit Lifting	All Foundation 15-25 Ton Units

① Please check availability.

② See HVAC Knowledge Center for a list of compatible Carrier units.

③ FDD = Fault Detection & Diagnostics.

Information subject to change. Please confirm with current Product Data for current factory production.

For complete equipment / combination selections, installation instructions and warranty information, please refer to Product Data/Ratings and/or Installers Guides and Limited Warranty Handbooks.



It's Hard To Stop A Trane.®

Precedent™ Roof Curb Compatibility Information

Table LAC/IN-1-A – Precedent™ 3-5 Ton Roof Curb Compatibility

BAYCURB042* / FIACURB401*			
Y°C	T°C	WSC	WHC
036G / 033G	036G / 033G	036E / 036H	036H
048G / 043G	048G / 043G	048E / 048H	
060G / 063G	060G / 063G	060E / 060H	
060E / 063E	060E / 063E		

Table LAC/IN-1-B – Precedent™ 6-25 Ton Roof Curb Compatibility

BAYCURB043* / FIACURB402*			BAYCURB044* / FIACURB403*		BAYCURB027* / FIACURB404*
T/YSJ	WSC	WHC	T/YSJ	WSC	T/YSJ
T/YSJ	WSC	WHC	T/YSJ	WSC	T/YSJ
072A	060H	048H	150A1	120E	180A
090A	072H	060E			210A
102A	090H				240A
120A1	092H				300A
	102H				
	120H				

General Notes:

- ① T/YSJ120 high efficiency models and all T/YSJ150 need curb adapter if older generation Precedent™ and Voyager™ models
- ② If another manufacturers curb was used initially, the adapter curb may not fit.

Table LAC/IN-1-C – Convertible 3-10 Ton Curb Adapters

Model Number	Description
BAYQACB009*	Quick Adapt Roof Curb Converts Voyager I™ BAYCURB021* to Precedent™ 3 - 5 Ton BAYCURB042*
BAYQACB010*	Quick Adapt Roof Curb Converts Voyager II™ BAYCURB022* to Precedent™ 3 - 5 Ton BAYCURB042*
BAYQACB011*	Quick Adapt Roof Curb Converts Voyager I™ BAYCURB022* to Precedent™ 6 - 10 Ton BAYCURB043*
BAYQACB012*	Quick Adapt Roof Curb Converts Voyager II™ BAYCURB025* to Precedent™ 6 - 10 Ton BAYCURB043*
BAYQACB013*	Quick Adapt Roof Curb Converts Voyager I™ BAYCURB026* to Precedent™ 6 - 10 Ton BAYCURB043*
BAYQACB044*	Quick Adapt Roof Curb Converts Voyager™ BAYCURB026* to Voyager™ BAYCURB027*
FIAQACB026*	Curb Adapter, Converts existing BAYCURB026* to new C cabinet (FIACURB403*) use with TSJ150A
FIAQACB027*	Curb Adapter, Converts existing BAYCURB027* to new C cabinet (BAYCURB403*) use with TSJ150A
FIAQACB044*	Curb Adapter, Converts existing BAYCURB044* to new B cabinet (BAYCURB402*) use with TSJ072A-120A
BAYQACB500*	Quick Adapt Roof Curb Converts Carrier™ CRRFCURB001A01 to Precedent™ FIACURB401*
BAYQACB501*	Quick Adapt Roof Curb Converts Carrier™ CRRFCURB001A01 to Precedent™ FIACURB402*
BAYQACB502*	Quick Adapt Roof Curb Converts Carrier™ CRRFCURB001A03 to Precedent™ FIACURB402*
BAYQACB114*	Precedent E cabinet to Precedent D cabinet (BAYCURB044 to BAYCURB043)
BAYQACB115*	Precedent B cabinet to Precedent C cabinet (BAYCURB042 to BAYCURB043)

Note: If another manufacturers curb was used initially, the adapter curb may not fit

Light Commercial
Accessories/Information

Odyssey Footprint Information

Table LAC/IN-2-A — Allowable Elevation Difference: Cooling-only TTA above indoor unit

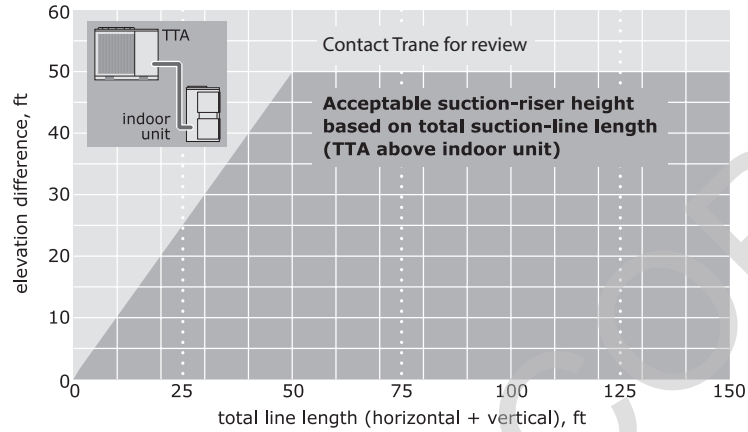

Table LAC/IN-2-B — Allowable Elevation Difference: TWA heat pump above indoor unit

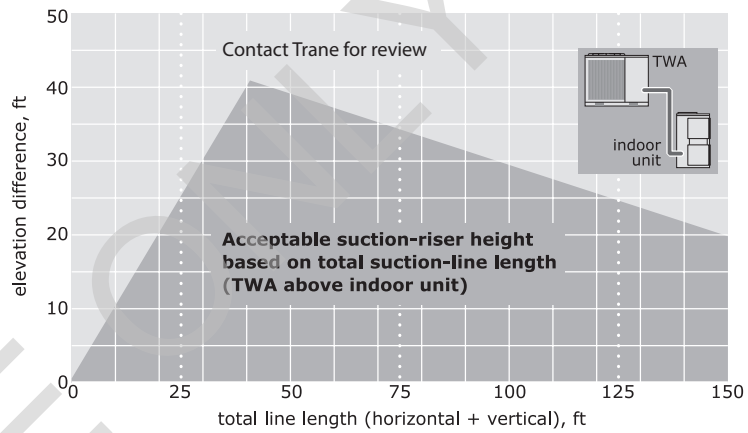
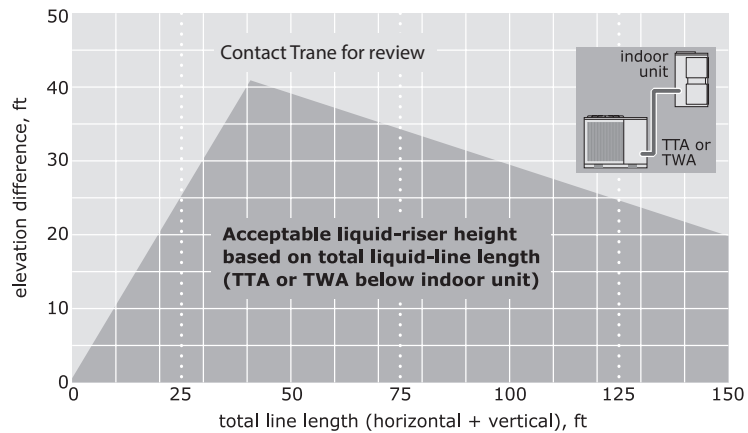

Table LAC/IN-2-C — Allowable Elevation Difference: TTA or TWA above indoor unit



Light Commercial
Accessories/Information



It's Hard To Stop A Trane.®

Zone Sensors



BAYSENS077

Zone Temperature Only

Provides temperature input only. Can be used as a secondary remote temperature input for thermostats.

- Remote Zone Sensor
- Use With:
BAYSTAT150, 152, 155
- Allows remote zone monitoring with standard electronic zone sensors

- Finish: Pantone Cool Gray #2C
- Replacement: SEN-0435
- Installation – 18-HD60D41
- Source: Clarksville



BAYSENS106

Manual Changeover

Heat, Cool or Off System Switch. Fan Auto or Off Switch. Single temperature setpoint thumbwheel.

- Single Setpoint
- Manual Changeover
- Use With:
3 – 10 Ton Precedent™ Units T°C, Y°C
- 12.5 – 25 Ton Voyager™ Units
- Heat/Off/Cool System Switch
- Auto/On Fan Switch

- Blue Cool/Red Heat Setpoint Levers
- Single Setpoint requires 4 wires for Electric/Electric
- Finish: Pantone Cool Gray #2C
- Replacement: SEN-1526
- Installation – 18-HD60D28
- Source: St. Paul GCC/Clarksville



BAYSENS108

Manual/Automatic Changeover

Auto, Heat, Cool or Off System Switch. Fan Auto or Off Switch. Dual temperature setpoint sliders.

- Dual Setpoint
- Manual or Auto Changeover
- Use With:
3 – 10 Ton Precedent™ Units T°C, Y°C
- 12.5 – 25 Ton Voyager™ Units
- Heat/Auto/Off/Cool Switch

- Auto/On Fan Switch
- Blue Cool/Red Heat Setpoint Levers
- Finish: Pantone Cool Gray #2C
- Replacement: SEN-1513
- Installation – 18-HD60D34
- Source: St. Paul GCC/Clarksville



**BAYSENS073
BAYSENS074
BAYSENS075**

Integrated Comfort™ System

Sensor(s) available with optional temperature adjustment and override buttons to provide central control through a Trane Integrated Comfort system.

BAYSENS073A

- Room Sensor with Timed Override
- Use with Integrated Comfort™ Systems
- Use With:
3 – 10 Ton Precedent™ Units
12.5 – 25 Ton Voyager™ Units
- Timed Override Buttons
- Finish: Pantone Cool Gray #2C
- Replacement: SEN-1447
- Installation – Included with sensor
- Source: Clarksville

BAYSENS074A

- Room Sensor with Setpoint Adjustment
- Used with Integrated Comfort™ Systems
- Use With:
3 – 10 Ton Precedent™ Units
12.5 – 25 Ton Voyager™ Units
- Timed Override Buttons
- Thumbwheel Setpoint
- Finish: Pantone Cool Gray #2C
- Replacement: SEN-1450
- Installation – Included with sensor
- Source: Clarksville



It's Hard To Stop A Trane.®

Zone Sensors



BAYSENS135

Wired Display Sensor

LCD display that provides heat, cool, auto, or off. Includes two temperature setpoints and a lockable setting with °F or °C indicators.



BAYSENS800

Touchscreen Digital Display Communicating Sensor

Uses BACnet MS/TP link to communicate zone temperature and setpoints. Auto, Heat, Cool or Off System Switch. Fan Auto or On Switch. 7-day programmable thermostat with night setback.

Note: Not compatible with VAV units. Requires BACnet communications



BAYSENS036

Wired Zone Temperature and Humidity Sensor

Measures temperature and relative humidity. Relative humidity input is used to control activation of dehumidification.

Light Commercial
Comfort Controls/Zone Sensors

Air-Fi Wireless Communicating Zone Sensors



BAYSENS077

Wireless Zone Temperature Only

Measures temperature and optional humidity (with WCS-SH) for use in public spaces where no local user interface is preferred.

Note: Requires BACnet communications



BAYSENS106

Wireless Display Sensor

Easy-to-use interface for clear and simple monitoring and control. Can be configured for any Trane system or to meet the customer's preference.

Note: Requires BACnet communications



X13790422010

Wired CO₂ Sensor

The maintenance-free carbon dioxide (CO₂) sensor is primarily used for demand control ventilation applications.



It's Hard To Stop A Trane.®

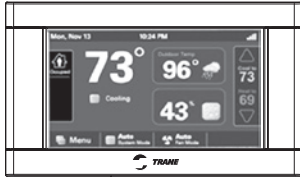

Trane® Pivot™
TCONT830AS52DA
(Commercial Applications Only)

Thermostats

Our Pivot Smart Thermostat system is great for commercial buildings. With its intuitive touchscreen and customizable display, it is easy for occupants to use. The Trane Pivot mobile app enables users to control multiple buildings remotely, making changes in seconds to all systems

Note: Not compatible with VAV units.

TCONT830AS52DA

- Service Support with diagnostics ①
- Designed for commercial business
- Customized display widgets
- 3 levels of access restrictions
- Manage user by enable/disable per mobile device
- 7 day programmable up to 6 events per day (3 occupied/3 unoccupied)
- Single button override for after hour use
- Configurable timed override logic
- Grouping for mass overrides
- Trane Pivot connected to the mobile app and diagnostics
- Efficient remote management
- Schedule can be sent to multiple Pivot thermostats
- Grouping for mass overrides
- Touchscreen Display: 4.15" x 2.65" (4.3" diagonal)
- Limited Warranty: 5-Year Material

Application:

- Conventional HVAC system compatibility with up to 3 heat/2 cool dual fuel (gas/electric)
- Heat pump systems:
- Up to 5 stages heat/2 stages cool (2 compressor plus 3 auxiliary)
- Heat pump switchover valve
- Selectable with cool or heat
- Wired remote indoor sensor (ZZSENSAL0400AA)
- Wired remote outdoor sensor (BAYSEN01ATEMPA)
- Two auxiliary outputs (dry contacts) for dehumidification, humidification, or ventilation
- System Modes: Auto, Heating, Cooling, Off
- Fan Modes: Auto, On
- Auxiliary Heat Lockout: 32°F to 70°F
- Compressor Heat Lockout: 55°F to 70°F
- Cooling Setpoint Range: 60°F to 99°F (1°F resolution)
- Heating Setpoint Range: 55°F to 99°F (1°F resolution)
- Indoor Temperature Display Range: 140°F to 122°F
- Outdoor Temperature Display Range: -40°F to 140°F
- Indoor Humidity Range: 0% to 100% (1% resolution)
- Minimum Cycle Off Time Display: Compressor; 5 minutes, Indoor Heat; 1 minutes
- Storage/Operating Temperature: -0°F to 175°F, 5% to 95% RH non-condensing
- 24 Volts AC

Dimensions:

- Product: 5.43"w x 3.39"h x 1.30"d
- Display: 4.15"w x 2.65"h



It's Hard To Stop A Trane.®

Thermostats



BAYSTAT152

Touchscreen Programmable Thermostat with Relative Humidity Sensor (3H/2C)

Three Heat, Two Cool digital display thermostat with built-in humidity control. This thermostat combines both humidity and temperature into one

Note: Not compatible with VAV units.

- Large, Clear Display with Backlighting — Current temperature, set temperature and time are easy-to-read and all are displayed on the main screen.
- Menu Driven Programming — Provides guidance through the scheduling process, showing only necessary information and choices on each screen.
- Real-Time Clock — Keeps time during power failure; automatically updates for daylight savings.
- Internal Humidity Sensor
- Manual or Auto Changeover
- 2 or 4 Scheduling Periods
- Precise Temperature Control (± 0.05 °F) — reliable, consistent comfort.
- Multiple OVERRIDE options — Can modify schedule indefinitely or for a specific period of time.
- 3 Heat/2 Cool



BAYSTAT150

Digital Display Programmable Thermostat (3H/2C)

- Three Heat / Two Cool
- Auto changeover digital display thermostat.
- 7-day programmable thermostat with night setback.

Note: Not compatible with VAV units.



BAYSTAT151

Digital Display Programmable Thermostat (1H/1C)

- One Heat / One Cool
- Auto changeover digital display thermostat.

Note: Not compatible with VAV units.



BAYSTAT155

Digital Display Thermostat (3H/2C)

- Three Heat / Two Cool
- Auto changeover digital display thermostat.

Note: Not compatible with VAV units.

UPGRADE YOUR WEBSITE WITH CURRENT TRANE PRODUCT INFO

IN NO TIME.

Take advantage of our fully embeddable, customizable Trane Online Product Guide.



HOW DO I GET STARTED?

- STEP 1** Go to TraneProducts.com/db and register for **FREE**
- STEP 2** Follow the simple on-screen instructions
- STEP 3** Copy your unique IFRAME code to your website

WHAT HAPPENS NEXT?

Instantly, the full line of Trane Products will be displayed on your website and will be updated whenever there are changes!

- ✓ One-time set up (Automatically Updates)
- ✓ Can be full-frame or within a div
- ✓ Fully responsive for mobile applications
- ✓ Select which products will appear on your website

ONLINE ONLY COPY

WE ARE COMMITTED TO USING ENVIRONMENTALLY FRIENDLY PRINTING PRACTICES.



It's Hard To Stop A Trane.

All trademarks referenced are the trademarks of their respective owners.

About Trane

Trane - by Trane Technologies (NYSE: TT), a global climate innovator - creates comfortable, energy efficient indoor environments for commercial and residential applications. For more information, visit Trane.com or TraneTechnologies.com

© 2023 TRANE. ALL RIGHTS RESERVED. 22-8301-36 01/23