

Installer's Guide

Whole House Air Cleaner Internal Control Board Replacement

ALL phases of this installation must comply with NATIONAL, STATE AND LOCAL CODES.

Important: This Document is customer property and is to remain with this unit. Please return to service information pack upon completion of work.



Contents:

Section 1.	Installation Requirements	1
Section 2.	Safety and Warnings	1
Section 3.	Remove Control Board	2
Section 4.	Install Control Board	3
Section 5.	950 Control	3

Section 1. Installation Requirements

- 7/64" Allen Wrench
- 1/4" Nut Driver
- Small Flat-blade Screwdriver
- Replacement Board (Part Number CNT06888)

Section 2. Safety and Warnings

⚠ WARNING

This information is for use by individuals having adequate backgrounds of electrical and mechanical experience. Any attempt to repair a central air conditioning product may result in personal injury and/or property damage. The manufacturer or seller cannot be responsible for the interpretation of this information, nor can it assume any liability in connection with its use.

⚠ WARNING

RISK OF ELECTRIC SHOCK: disconnect all electrical power, including remote disconnects before installing or servicing. Follow proper lockout/tagout procedures to ensure the power cannot be inadvertently energized. Failure to follow this warning could result in serious personal injury, death or property damage.

⚠ CAUTION

SAFETY HAZARD! Sharp Edge Hazard. Be careful of sharp edges on equipment or any cuts made on sheet metal while installing or servicing. Personal injury may result.

Section 3. Remove Control Board

3. 1. Remove the wiring assembly in the corner of the Door Panel.

WAIT AT LEAST 15 SECONDS FOR SYSTEM CHARGE TO DISSIPATE BEFORE PROCEEDING TO NEXT STEP.



REMOVE 24 VOLT
POWER / CONTROL
CABLE

3. 2. Remove the Door Assembly from Whole Home Air Cleaner by pulling away from the unit assembly. Place on the flat and clean working surface with interior components facing up.

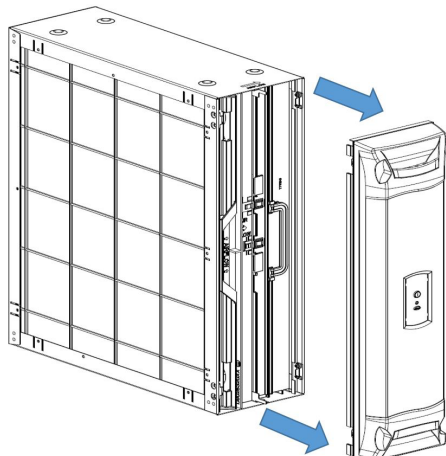

3. 3. Remove the hex-head perimeter screws on the back side of the Assembly. **Note:** Some units have eight perimeter screws, other units have ten perimeter screws.

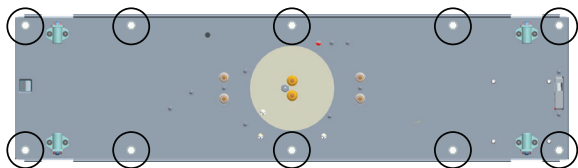

Remove the Hex-head screws on
the back side of the Assembly

3. 4. Flip the door Assembly over.

3. 5. Using the two recessed handles on the front of the Door separate the panel from the Assembly Plate.

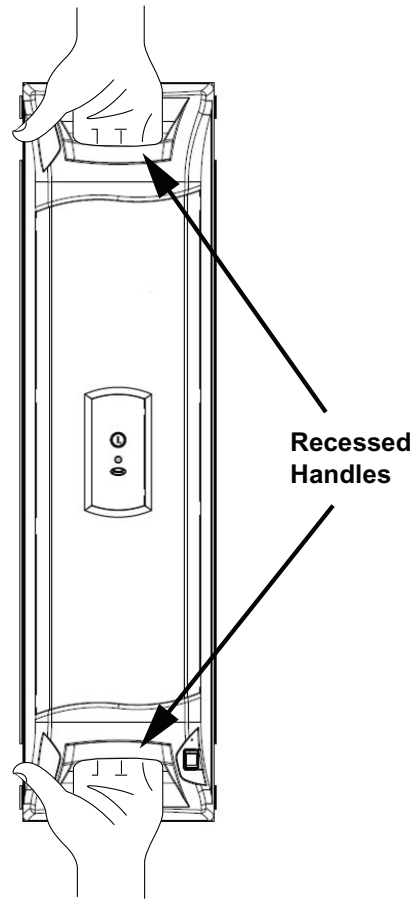

Recessed
Handles

3. 6. Locate the Internal Control Board. Remove the 20-wire Molex connector from the Internal Control Board by depressing the tab on the plug and lifting up on the plug.

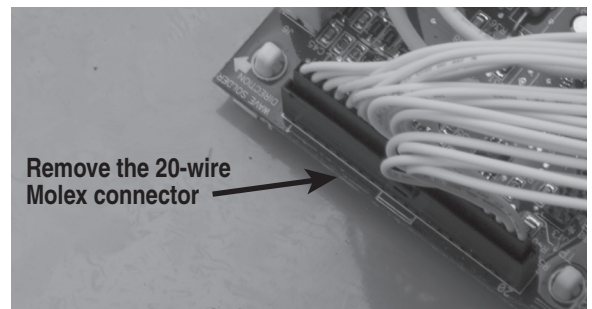

Remove the 20-wire
Molex connector

3. 7. Remove the 5-wire Molex connector from the Control Board.

3. 8. Note the position of the Yellow, White and Green wires in terminals J1, J2 and J5. Remove the three wires from the Control Board being sure to grasp the connectors and not the wires directly.

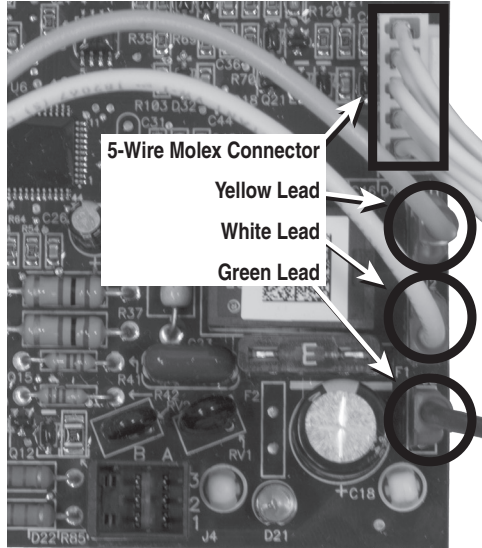

3. 9. Remove the Control Board from the Assembly Plate by depressing each of the four plastic standoffs with a small flat blade screwdriver while simultaneously pulling up on the Board's edges.

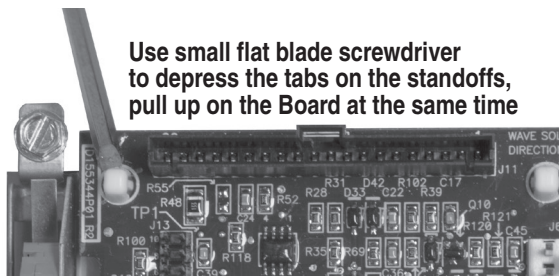

3. 10. Place the old Board to the side.

Section 4. Install New Control Board

4. 1. Align the Replacement Control Board (CNT06888) with the four plastic standoffs on the Assembly Plate.

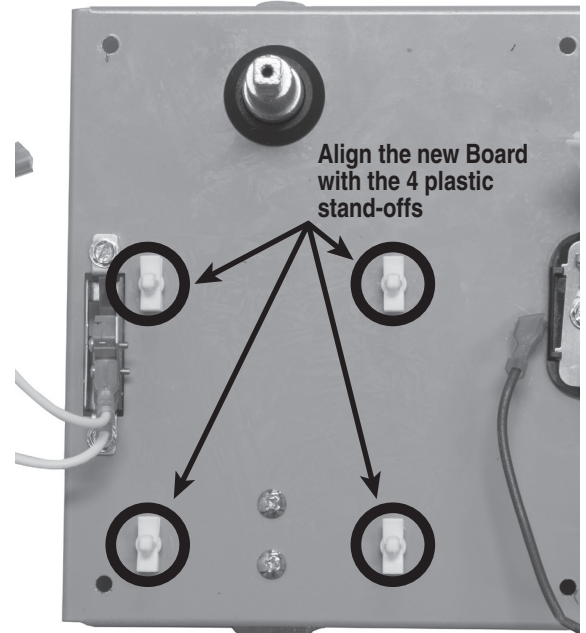

4. 2. Align the Control Board in the same orientation as the original Board with plug J4 towards the long edge of the Assembly. Carefully press down on the Control Board until it snaps into place on the plastic standoffs.

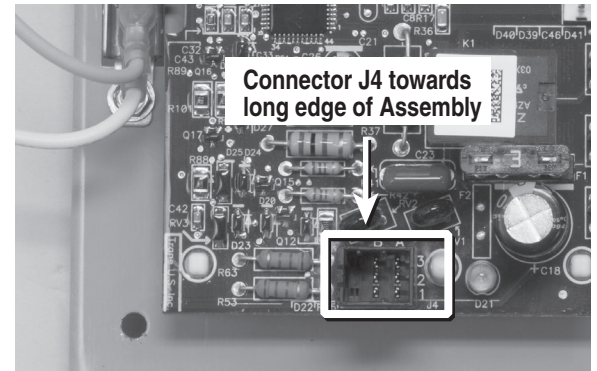

4. 3. Reattach the Yellow lead to terminal J1. Reattach the White lead to terminal J2. Reattach the Green lead to terminal J5. Be sure the connectors are firmly seated on the Board.

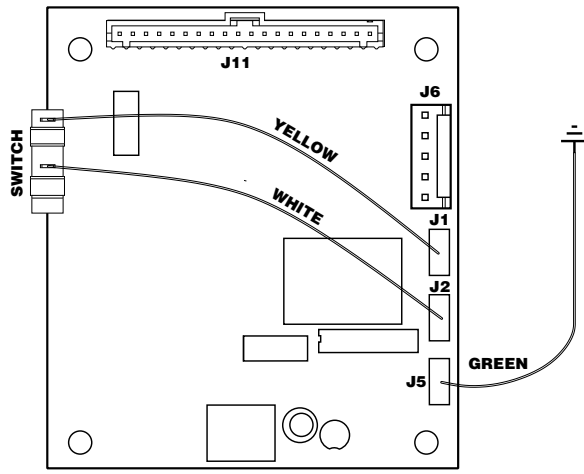

TYPICAL CONTROL BOARD

4. 4. Reattach the 5-wire Molex plug to the Control Board, pressing down until it snaps into place.

4. 5. Position the Assembly Plate near the Door Panel and reattach the 20-wire Molex connector. Make sure it is firmly seated on the Control Board.

4. 6. Align the Door Panel with the two door latch posts on the Assembly Plate and slide the Panel into place.

4. 7. Reinstall each of the two door latches in their original location.

4. 8. Flip the Assembly over and replace the ten screws on the back side of the Assembly. Do not overtighten screws.

4. 9. Return the Door Assembly to the Whole Home Air Cleaner unit and secure in place.

4. 10. Power up unit and confirm LEDs.

Section 5. 950 Control

5. 1. The replacement Control Board does not contain a designated model or serial number. The System Information screen on the 950 Control will display "ACCE" and the software version number. It will not display the model or serial number of the air cleaner.

About Trane and American Standard Heating and Air Conditioning

Trane and American Standard create comfortable, energy efficient indoor environments for residential applications. For more information, please visit www.trane.com or www.americanstandardair.com



Intertek

The manufacturer has a policy of continuous data improvement and it reserves the right to change design and specifications without notice. We are committed to using environmentally conscious print practices.