

# SC360 System Controller / UX360 Smart Thermostat

## Zoning Installation Guide

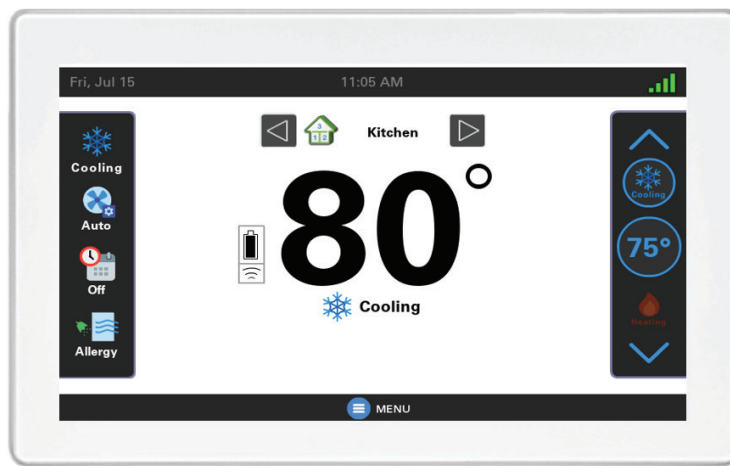

**Model ZZON2PNLA200ZA**

With Link technology

**ALL phases of this installation must comply with NATIONAL, STATE AND LOCAL CODES.**

**IMPORTANT - Proper application is critical when installing zoning systems. Not done correctly, the HVAC and zoning system will not provide the expected comfort. Reference application bulletins CNT-APG003-EN/Trane and CNT-APG004-EN/AS for detailed information on Zoning Application.**

**IMPORTANT** - This Document is customer property and is to remain with this unit. Please return to service information pack upon completion of work.

These instructions do not cover all variations in systems or provide for every possible contingency to be met in connection with the installation. Should further information be desired or should particular problems arise which are not covered sufficiently for the purchaser's purposes, the matter should be referred to your installing dealer or local distributor.

## Contents

1. Safety .....	2	8. Link Zoning Commissioning .....	18
2. Zoning Overview .....	2	9. Zone 1 Sensor Setup.....	28
3. General Information.....	3	10. Sensor Assignment.....	29
4. Link Zoning Preparation and Mounting.....	4	11. Zoning Airflow Test .....	33
5. Zoning Components.....	5	12. Zoning Settings and Parameters .....	37
6. Pre-configuration zoning checklist .....	13	13. Zone Panel Replacement .....	39
7. Trane/AS Diagnostics Mobile App .....	14		

## 1. Safety

### WARNING

This information is intended for use by individuals possessing adequate backgrounds of electrical and mechanical experience. Any attempt to repair a central air conditioning product may result in personal injury and/or property damage. The manufacturer or seller cannot be responsible for the interpretation of this information, nor can it assume any liability in connection with its use.

### WARNING

#### **LIVE ELECTRICAL COMPONENTS!**

During installation, testing, servicing, and troubleshooting of this product, it may be necessary to work with live electrical components. Failure to follow all electrical safety precautions when exposed to live electrical components could result in death or serious injury.

## 2. Zoning Overview

SPECIFICATION	DESCRIPTION
Model	ZZON2PNLA200ZA
Product	Link Zone Panel
Size	6.2" width x 5.0" height x 1.2" depth
Storage Temperature	-40 °F to + 175 °F, 5% to 95% RH non-condensing
Operating Temperature	-40 °F to + 150 °F, 5% to 95% RH non-condensing
Input Power*	24VAC from external transformer (Range: 18~30VAC)
Power Consumption	2VA for each Zone Panel (damper VA not included)
Wire Usage	Minimum 18-gauge NEC approved control wiring
Communications	CAN BUS /CAN System Bus

\* On every application, 24VAC loads should be reviewed to be sure the indoor unit control power transformer is adequately sized.

### 3. General Information

#### 3.1 What's in the Box?

Zone Panel Kit SKU	Zone Expander SKU	8x Distribution Kit SKU
1 - Zone Expander Assembly	1 - Zone Panel Assembly	1 - 8x Distribution Board Assembly
1 - 8x Distribution Board Kit	1 - Zone Panel Installer's Guide	1 - 8x Distribution Board Installer's Guide
1 - Box with labeling	2 - Field wiring CAN connectors (in a bag)	1 - CAN bus harness - 6 ft (1 <sup>st</sup> dist. board to 2 <sup>nd</sup> dist. board)
	4 - Zip ties	10- Field wiring CAN connectors (in a bag)
	1 - CAN bus harness - 6 ft (dist. board to ZP or 1ZP to 2ZE)	4 - Mounting screws, 4 Wall anchors
	4 - Mounting screws, 4 Wall anchors	1 - Box with labeling
	1 - Box with labeling	

#### 3.2 Accessories

Zoning settings are available only when a Zone Panel is connected and discovered on the system bus.

##### Sensor Accessories:

- Wired Remote Indoor Sensor (ZZSENSAL0400AA)
- Wireless Remote Air Temperature Sensor (ZSENS930AW00MA)

##### Zoning Accessories:

- Zone Kit (ZZON2KITA200ZAA, contains a Panel and a Large Distribution Board)
- Zone Panel (ZZON2PNLA200ZA, Panel only, no Distribution Board)
- Small (4x) Distribution Board (BDIS2SMLA200UAA)
- Large (8x) Distribution Board (BDIS2LRGA200UAA)
- Modulating Zone Dampers (round, rectangular and slip-in dampers are available)

Zone Panel(s) must be powered. **Following are the steps required before enabling zoning:**

1. Zone Panel(s) must be connected to the communicating bus (R, DH, DL, B).
2. All non-communicating zone temperature sensors must be connected to the corresponding zone slots.
3. One UX360 thermostat and one SC360 system controller must be connected to the communicating bus.
4. All dampers should be installed and connected to the corresponding zone damper output.

## 4. Link Zoning Preparation and Mounting

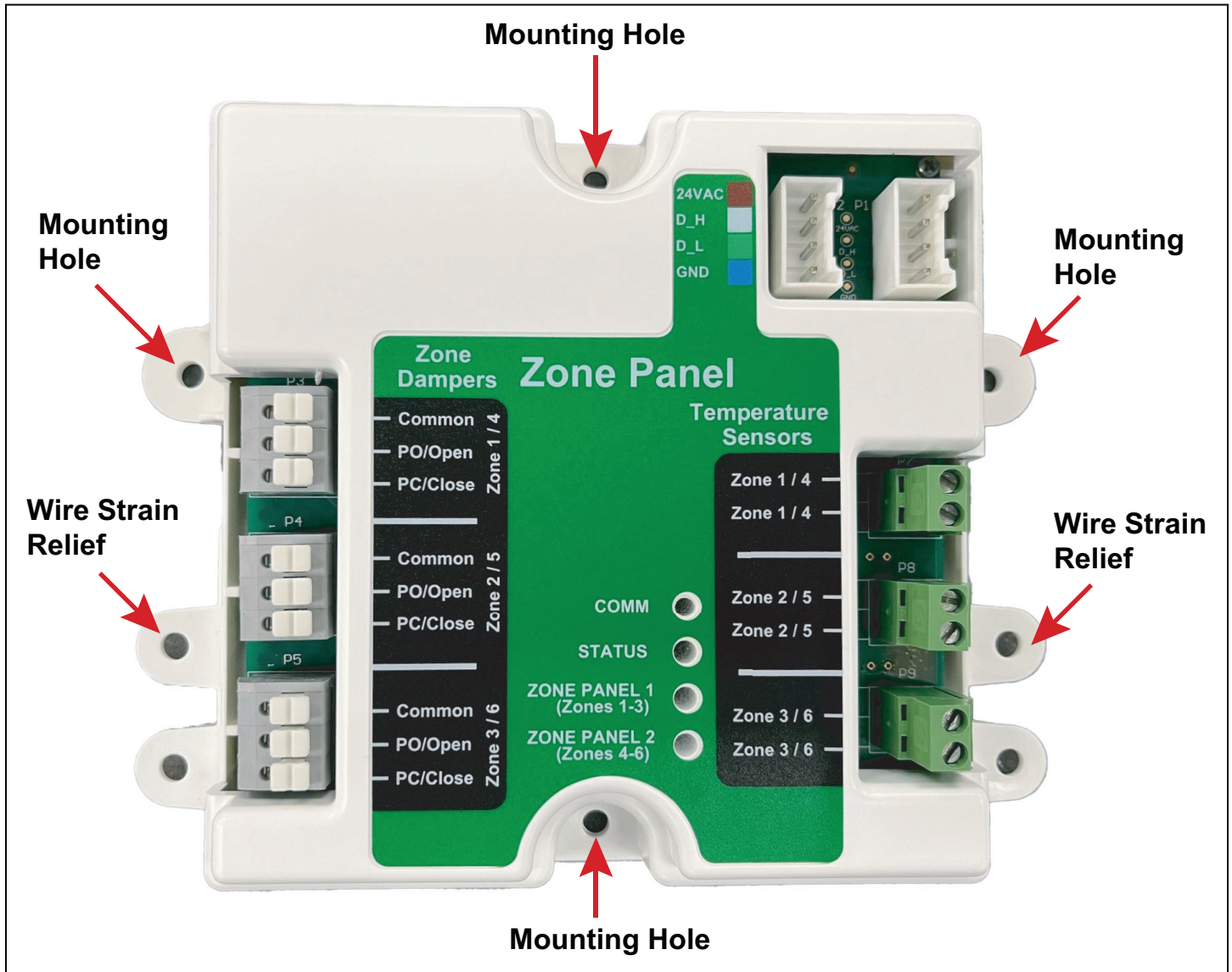

Follow the below steps to mount the Link Zoning Controller:

1. **Mounting to studs:** Drill 1/8" pilot holes in the four locations marked.
2. **Mounting to drywall:** If mounting to drywall with no studs behind it, enlarge pilot holes to 3/16" for anchors. Gently tap anchors into the holes.
3. Align Link Zoning Controller to the holes.
4. Attach base to the wall using four screws provided. Do not over tighten.

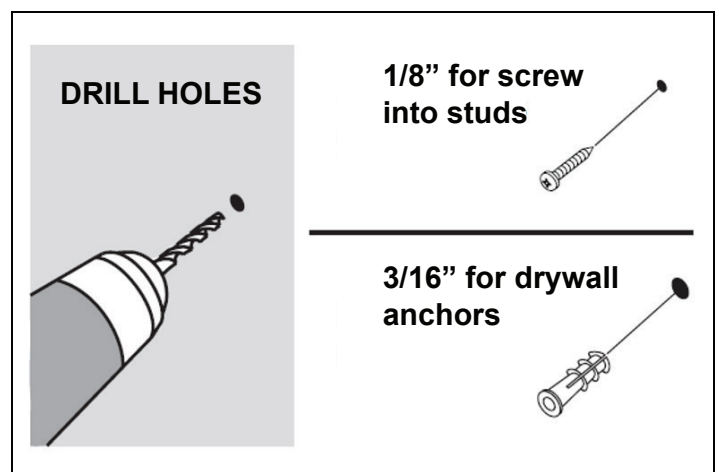

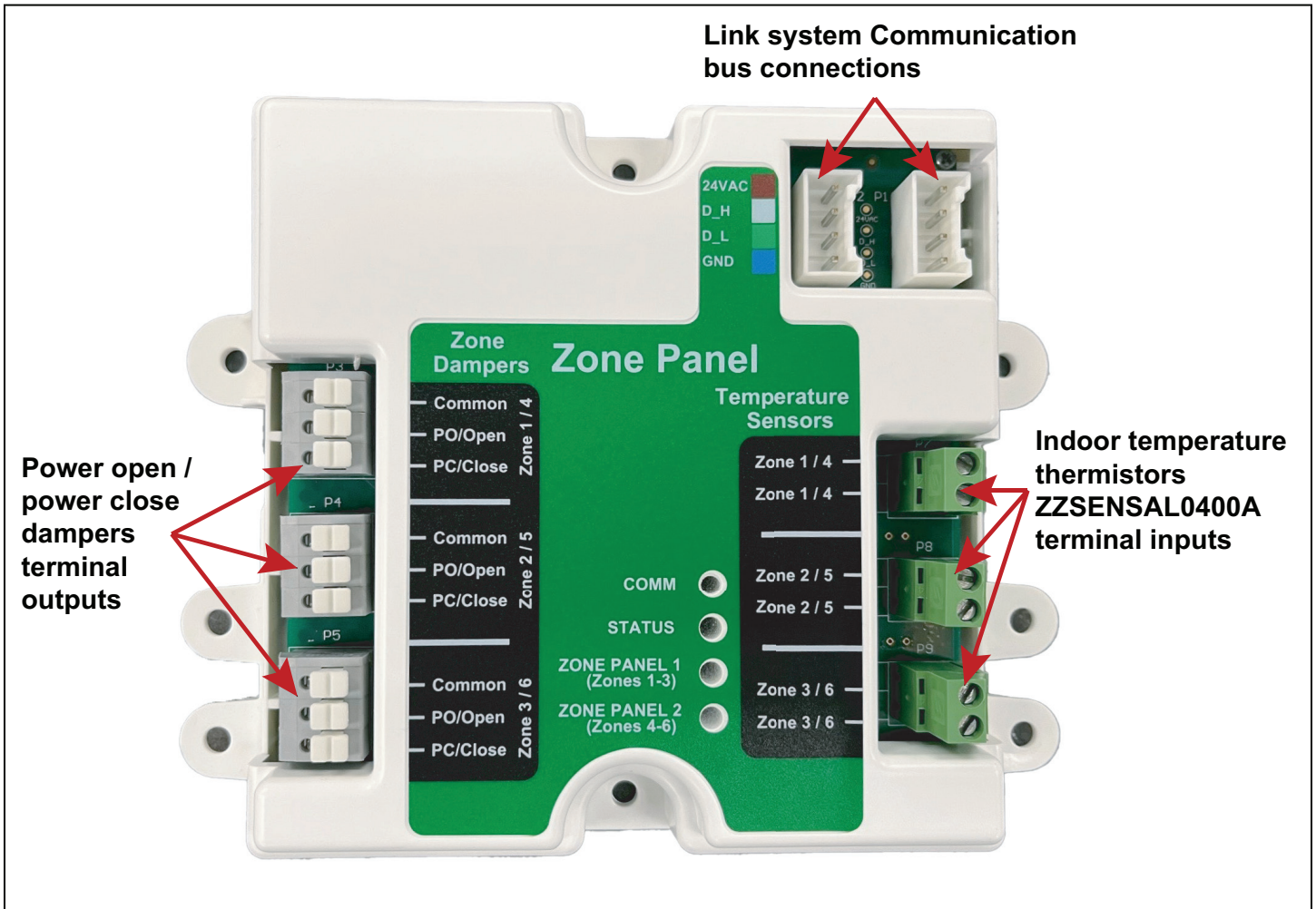

## 5. Zoning Components

### 5.1 Label the wires:

Zoning requires a lot of wires.

- Wires to the damper motors
- Wires to the zone sensors
- Wires to the communicating system

It is recommended to label each wire after pulling it to its location.

Crossing wires between components can add hours of troubleshooting time to the commissioning process.

Labeling can be done with a wire tag or use a fine-tip permanent marker and write on the jacket of the stat wire as shown.

**IMPORTANT:** Be careful to provide plenty of room to strip the wire back without removing the labeling.

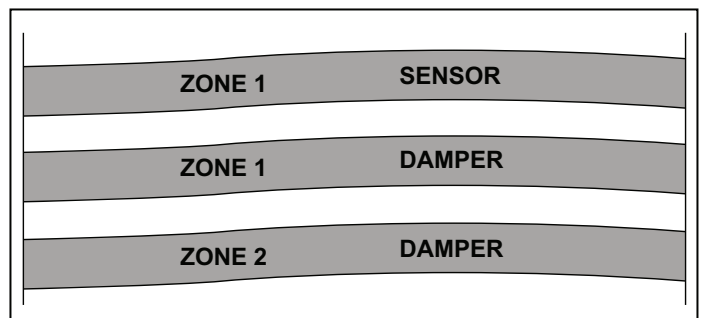

**5.2 Damper Wiring/System Notes:**

Zone Dampers		
Terminal	Description	Color Used
Zone 1	Common	
	Power Open	
	Power Closed	
Zone 2	Common	
	Power Open	
	Power Closed	
Zone 3	Common	
	Power Open	
	Power Closed	
Zone 4	Common	
	Power Open	
	Power Closed	
Zone 5	Common	
	Power Open	
	Power Closed	
Zone 6	Common	
	Power Open	
	Power Closed	

Wired Thermistor		
Terminal	Description	Color Used
Zone 1	Common	
	Power Open	
	Power Closed	
Zone 2	Common	
	Power Open	
	Power Closed	
Zone 3	Common	
	Power Open	
	Power Closed	
Zone 4	Common	
	Power Open	
	Power Closed	
Zone 5	Common	
	Power Open	
	Power Closed	
Zone 6	Common	
	Power Open	
	Power Closed	

**5.3 Low Voltage Wire Connectors:**

Link mode uses simple connectors for low voltage connections. These connections are color coded which makes the installation easier and quicker.

Wire Colors	
R	Red
DH	White
DL	Green
B	Blue

Do the following to make the connections from the actual thermostat wire to the connector.

**NOTE:** These connectors are necessary at the communicating outdoor unit, communicating indoor unit, distribution board(s), system controller and communicating accessories.

1. Strip the Red, White, Green, and Blue thermostat wires back 1/4".
2. Insert the wires into the connector in the correctly colored locations.
3. **When you feel it release, allow each wire to slide in further.**
4. Pull back on the wires individually and slightly and check if the wires are seated properly. If each wire does not pull out for all four wires, the connection is complete.
5. Connectors are **ONE-TIME-USE ONLY**. If the thermostat wire gets broken off inside of the connector, the connector must be replaced.

**NOTE:** DO NOT REUSE THE CONNECTOR – REPLACE IT INSTEAD.

6. Wire colors are for illustration purposes only. If using a different color, ensure it lands at the correct terminal throughout all of the communicating control wirings.

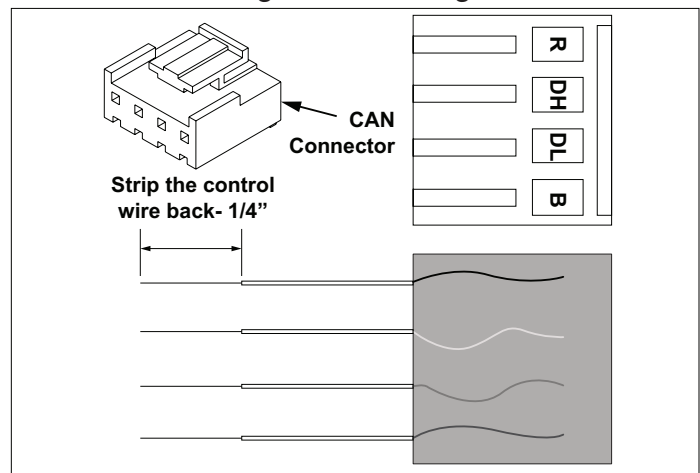

**NOTE:** For use with 18 ga. solid core thermostat wire.

### 5.4 Damper Wire Connectors:

The damper connectors are push-pin connectors. Follow the below instructions to ensure proper attachments/removal of wires:

1. Do not push the release tabs when inserting the wires.
2. Cut all stat wires to the same length to ensure all wires are inserted to the same depth within the connector.
3. Gently pull back on each wire to ensure it is fully seated.

**NOTE:** It is the recommended practice to strip the thermostat cable jacket back several inches and insert one wire at a time into the connector until you are sure it is seated.

4. To remove a wire, press on the release tabs and pull the wire from the connector.
5. Do not connect more than two wires per terminal. If more dampers are required, wire them together externally to the zone panel.

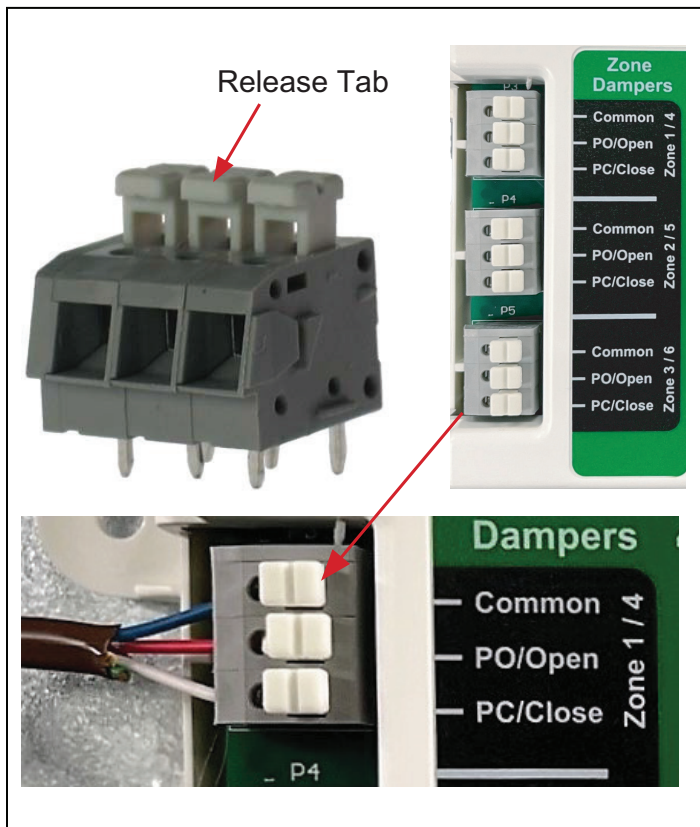

### 5.5 Duct Dampers:

- Each Link Zone panel can support up to three zones.
- Power open / power closed dampers are required.
- The damper relays can support up to four dampers per zone.
- Be consistent with the wire coloring throughout all damper connections.
- Each Trane/American Standard brand damper is rated at 1.5 VA.
- 60-second travel dampers are required. See the configuration section for details.

NEC Class II Control Wiring (24V)	
Wire Size	Max. Wire Length
18 AWG	150 ft
16 AWG	225 ft
14 AWG	300 ft

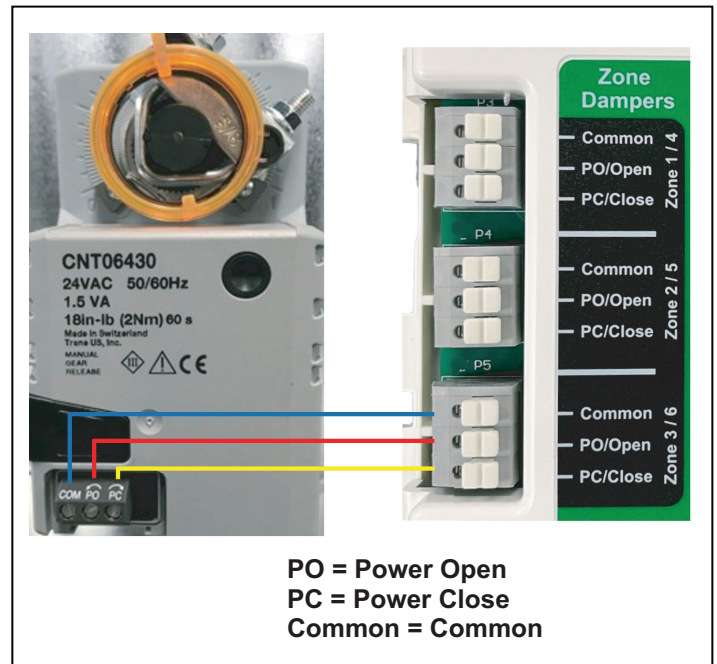

## 5.6 Wired Zone Sensors:

The right side of the zone panel is for wired thermistors:

### ZZSENSAL0400AA Wired sensors can be incorporated in several ways:

1. Standalone temperature sensing for a zone.
2. Multiple sensors are wired in a series / parallel circuit for averaging (see figure below).
3. In conjunction with other sensors for temperature averaging; using a wired sensor alongside a wireless sensor, thermostat or system controller. Wired temperature sensors connected to the zone panel are for temperature sensing only and **CANNOT sense relative humidity**.

**NOTE:** Do not connect more than two wires per wired temperature sensor terminal.

**NOTE:** Wired zone sensors can be used for averaging. Refer to the ZZSENSAL0400A installation guide for details.

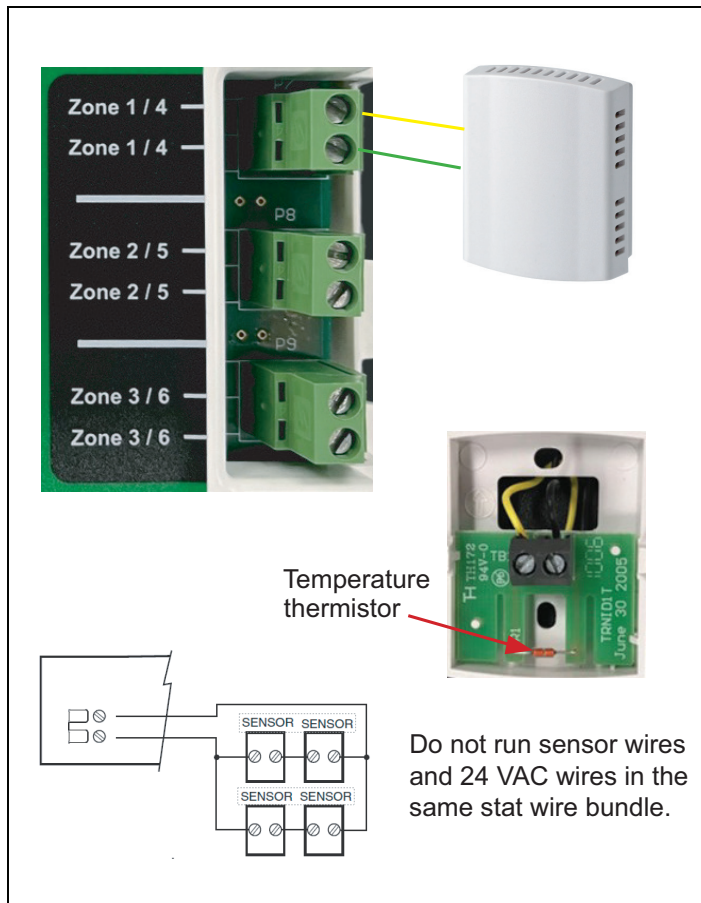

## 5.7 Component Wiring:

Control wiring is easy for installations and that only require a single transformer. The indoor unit transformer will power and control all components. Most components have multiple ports to make wiring easy:

- VS Outdoor Unit = 1 connection ports
- TAMX = 2 connection ports
- S8V2-C Furnace = 3 connection ports
- System Controller = 2 ports
- Zone Panel = 2 connection ports

**NOTE:** The system controller ships with a 4X distribution board to assist with point-to-point wiring if needed. With all components being powered from the same source, use the easiest connection method for the installation.

**NOTE:** The second port on the bottom of the hub can only be used when the hub wiring is OK to be exposed, e.g., flush mounting of the hub and wiring on a stud in unconditioned space.

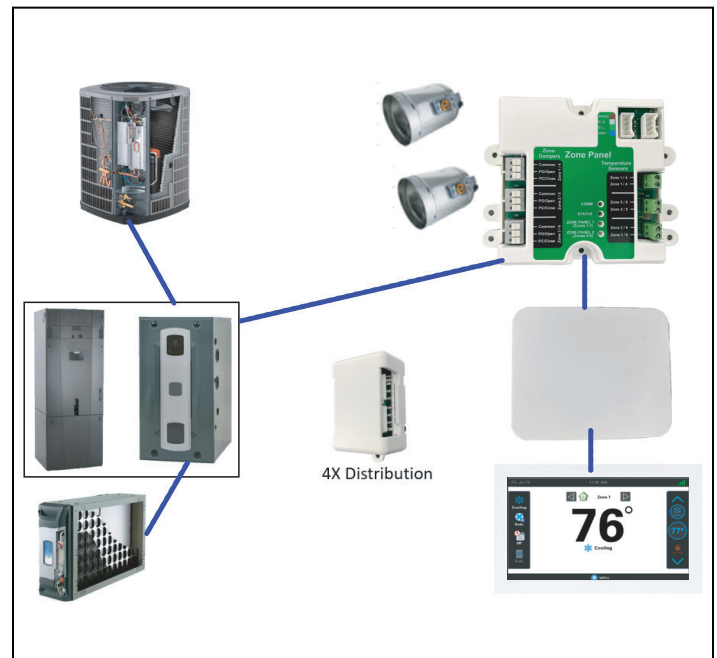

Control wiring is more challenging if a secondary transformer is needed. The 8X distribution board will also be required to isolate the transformer loads.

- The Indoor unit, outdoor unit, and air cleaner should be powered from the indoor unit transformer.



- Furnaces will require the installation of the 50VA transformer when incorporating an electronic air cleaner.

The Link control components (system controller, thermostat, and zone panels) will be controlled through the secondary transformer. The transformer that powers the zone panels will also power the dampers.

- This wiring technique separates the system loads from the zoning loads; allowing each transformer to control the dedicated components.

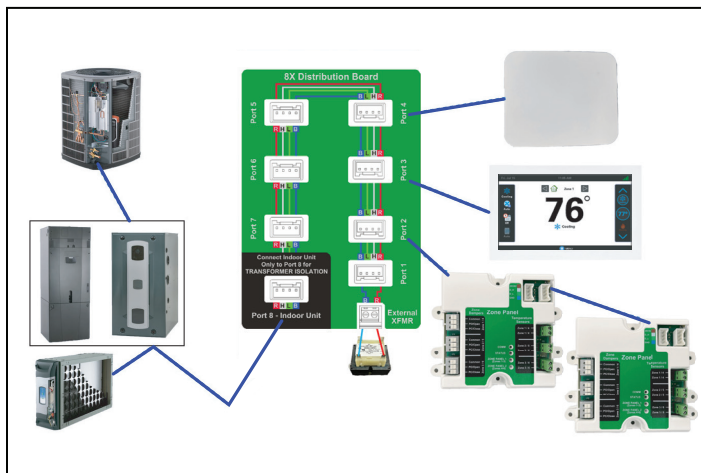

**5.8 8X Distribution Board:**

The bottom left header must be connected to the communication circuit from the indoor unit transformer whenever the calculated load requires the installation of a second transformer.

This connection provides Link communication to the distribution board and extends this communication to all devices connected to the 8X distribution board.

**NOTE:**

- The 24V R is not connected to port 8. This break in R eliminates the need for transformer phasing.*
- Since the two 24VAC transformers are isolated, phasing is not a concern.*
- Do not ground the secondary side of the second transformer.*
- Leave this secondary voltage floating.*

The 8X distribution board provides eight connection points for Link communication and the 24-volt power source.

The bottom of the distribution board has two dedicated headers for the secondary transformer and connection to the indoor unit.

Ports one through seven are to control devices from the second transformer load.

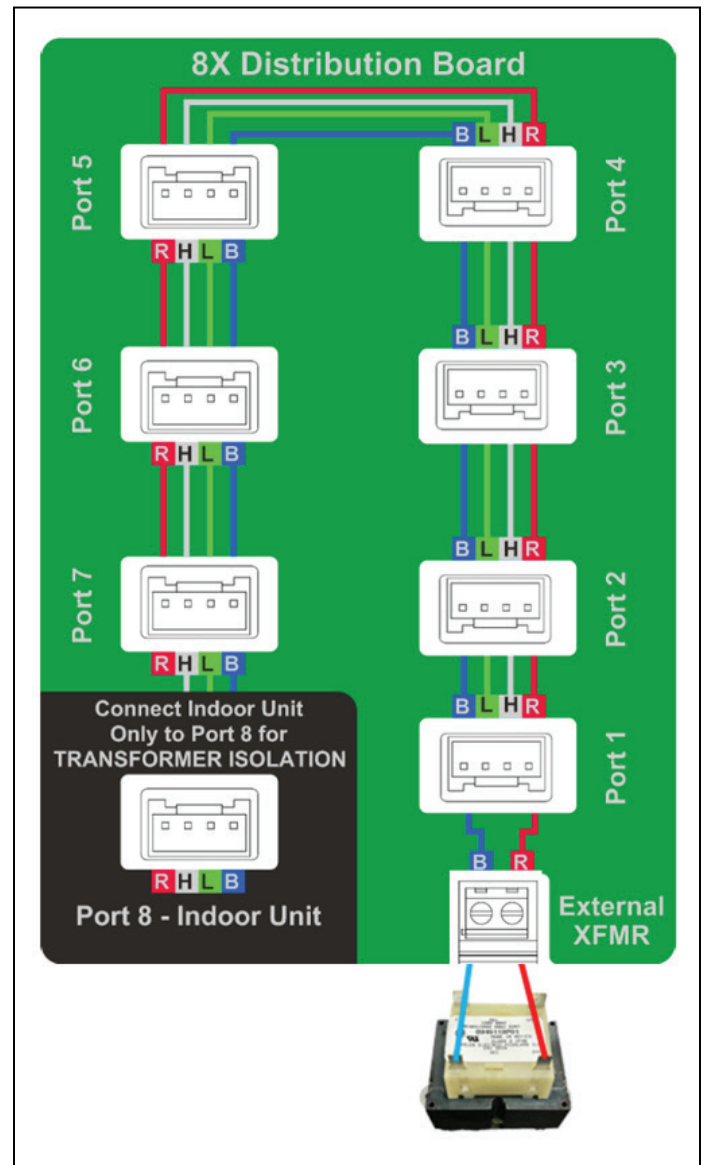

### 5.9 Transformer Sizing:

Most smaller zone systems will not require a secondary transformer.

This table shows the transformer loads in a Link communicating system; showing furnace and air handler loads within one table.

Use the following tables specific to the indoor unit type being installed components to determine if a secondary transformer is required to power the zoning components that will be connected to the 8X distribution board.

- Enter the quantity of each device
- Multiply the quantity as per the VA for each device
- Add up the Total VA per operating conditions  
This chart is based on worst-case conditions
- Each load is full load condition (FLA)
- All loads will never be energized at the same time

Unit	VA Each	Quantity	Total VA
System Controller	4		
Thermostat	8		
VS Outdoor Unit <sup>1</sup>	15		
TAMX Air Handler <sup>2</sup>	12		
Heater Relay <sup>3</sup>	4		
S8V2-CFurnace IFC <sup>4</sup>	11.3		
Furnace Gas Valve <sup>5</sup>	10.3		
Zone Panel	2		
Dampers	1.5		
Air Cleaner	20		
<b>Total System VA</b>			

1: SmartCharge™ Solenoid-Applicable only to cooling in SmartCharging Mode  
 2: AHC=10VA+2VA for onboard heater relays  
 3: 5VA per 5KW with TAMX (15KW heater = 15VA)  
 4: IFC = 5VA in idle / cooling mode; 11.3 VA for W2  
 5: W2 gas heat protection

**NOTE:** Fan power & bypass humidifiers require a separate transformer dedicated to the humidifier being installed.

**NOTE:** The only transformer load for the VS outdoor unit is the SmartCharge™ solenoid. This solenoid is only energized in the SmartCharge™ test mode. The TAMX indoor heat relays and furnace gas valve will be disabled during the SmartCharge™ test mode.

### 5.10 Air Handler Transformer Sizing:

Evaluate the Quantity and Total VA for each possible components in the system.

The Total System VA is based on worst-case conditions.

The air handler ships with a 75VA transformer.

This transformer can support Total System VA loads up to 80 VA without requiring a secondary transformer.

Heating Operation			
Unit	VA Each	Quantity	Total VA
System Controller	4		
Thermostat	8		
Air Handler	12		
Heater Relay	4		
Zone Panel	2		
Dampers	1.5		
Air Cleaner	20		
<b>Total System VA</b>			

Cooling Operation			
Unit	VA Each	Quantity	Total VA
System Controller	4		
Thermostat	8		
VS Outdoor Unit	15		
Air Handler	10		
Zone Panel	2		
Dampers	1.5		
Air Cleaner	20		
<b>Total System VA</b>			

**5.11 Furnace Transformer Sizing:**

Evaluate the Quantity and Total VA for each possible components in the system.

The Total System VA is based on worst-case conditions.

The furnace ships with a 35VA transformer.

This transformer can support Total System VA loads up to 40 VA without requiring a secondary transformer.

If a Communicating Air Cleaner (EAC or ACCE) is installed, install the 50 VA transformer that ships with the air cleaner.

The 50 VA EAC transformer can support Total System VA loads up to up to 55 VA without requiring a secondary transformer.

Heating Operation			
Unit	VA Each	Quantity	Total VA
System Controller	4		
Thermostat	8		
Furnace IFC	11.3		
Furnace Gas Valve	10.3		
Zone Panel	2		
Dampers	1.5		
Air Cleaner	20		
<b>Total System VA</b>			

Cooling Operation			
Unit	VA Each	Quantity	Total VA
System Controller	4		
Thermostat	8		
VS Outdoor Unit	15		
Furnace IFC	11.3		
Zone Panel	2		
Dampers	1.5		
Air Cleaner	20		
<b>Total System VA</b>			

Evaluate the quantity and total VA for each possible components in the system.

The Total System VA is based on worst-case conditions.

- Enter the quantity of each device
- Multiply the quantity per the VA for each device
- Add up the total VA per operating conditions for both Primary transformer and secondary to obtain Total system VA.

Secondary Transformer		
Component	VA Each	Total VA
	Secondary VA	
	Primary VA	
	Total VA	

### TAMX Zoned System

\* = The 4X Distribution Board may be used when ACCE is not applied.

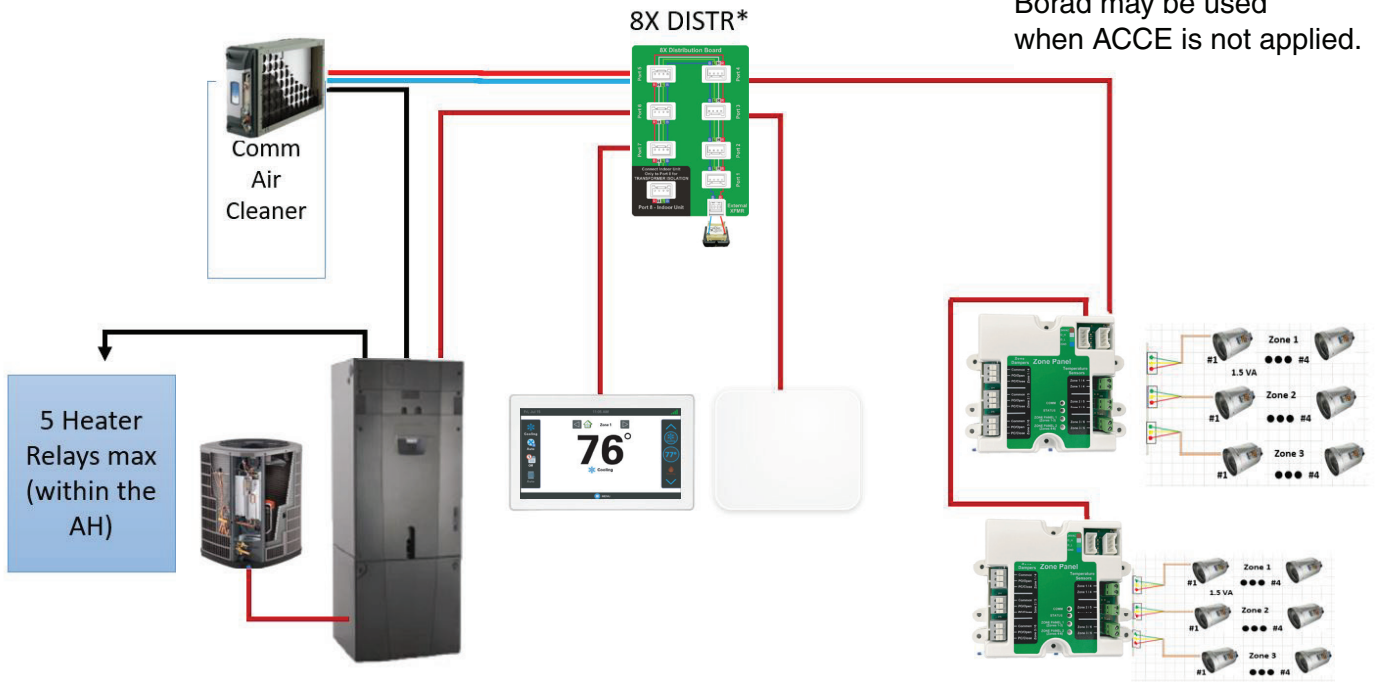

### Minimal Zoned 2 Stage Furnace System

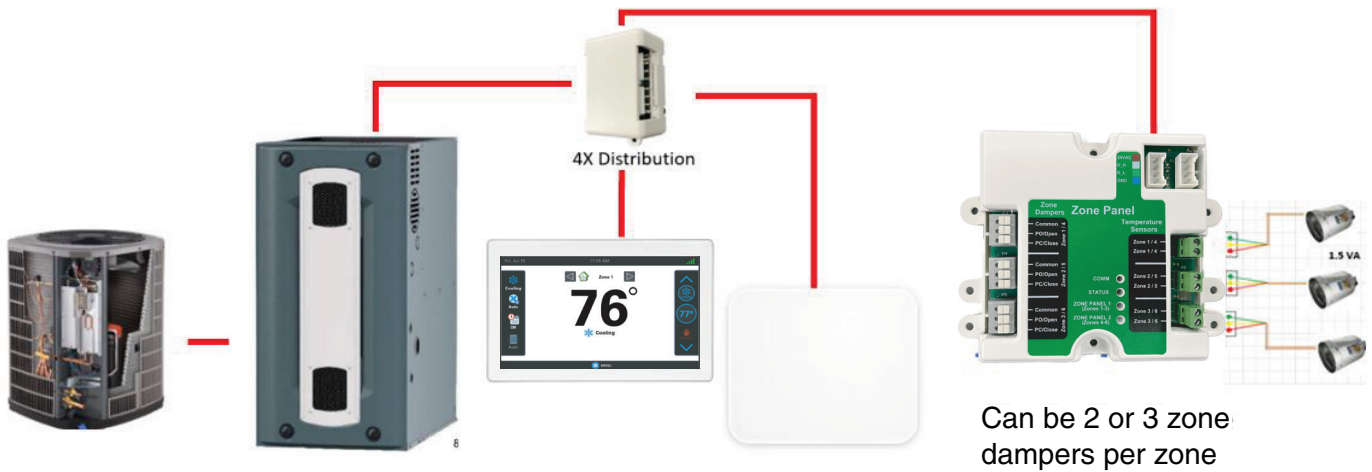

## 2 Stage Furnace Zoned System where the loads require an external transformer

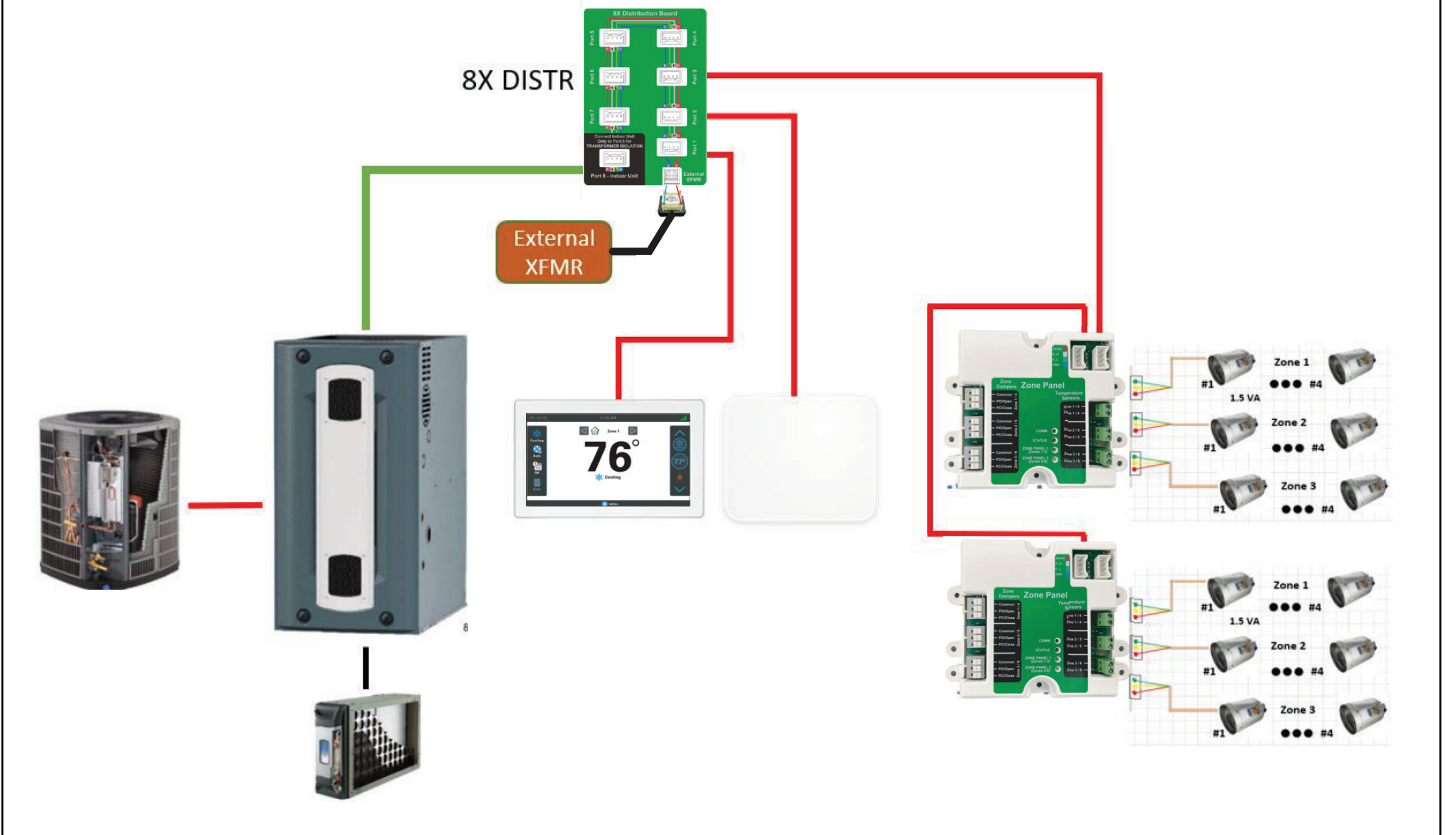

## 6. Pre-configuration Zoning Checklist

- All Link system components have CAN harness connections. Ensure all pieces of the system are connected and powered.
- Ensure all zone panels, dampers, and wired sensors are wired correctly to the intended zones.
- Zoning Configuration can be done from the Diagnostics Mobile App or the Thermostat, all tests and settings are available from either the Mobile App connected to a Link system or locally at the thermostat.

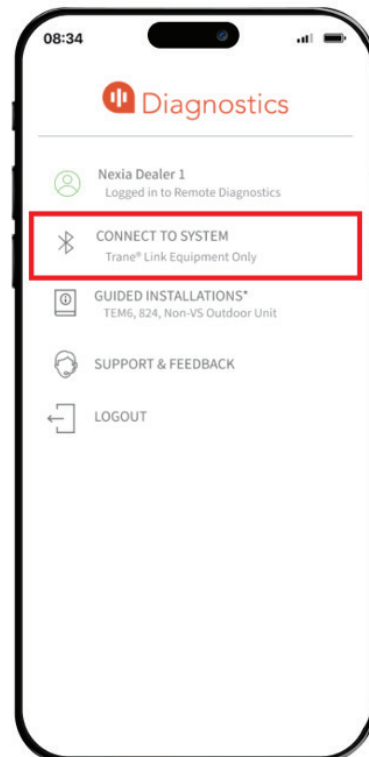
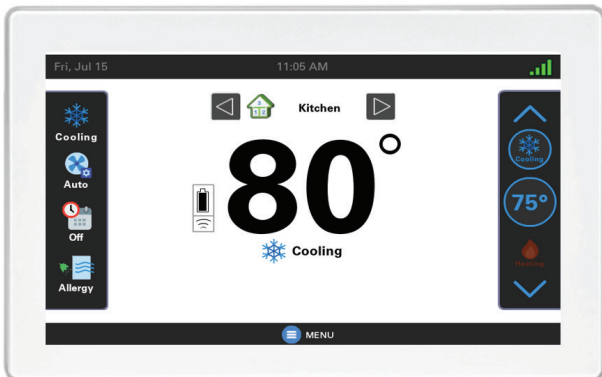

## 7. Trane or American Standard Diagnostics Mobile App

### 7.1 Download the App:

For ease of installation, zoning can also be configured and tested from the Trane or American Standard Diagnostics Mobile App.

Follow below steps to download the App:

1. Search “Trane Diagnostics” or “American Standard” in the App Store® or Google Play™ Store and click “Install” to download the app.
2. You can also scan the QR code and select “Trane” or “American Standard” from there.
3. Accept all permissions (Bluetooth, Location, Camera).



4. Accept the terms and conditions.

### Trane Diagnostics App

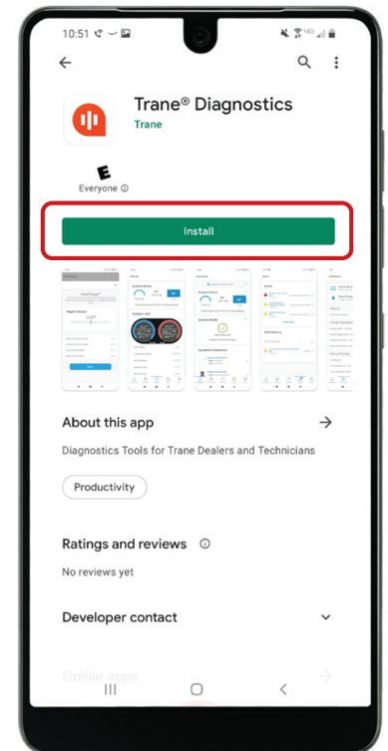
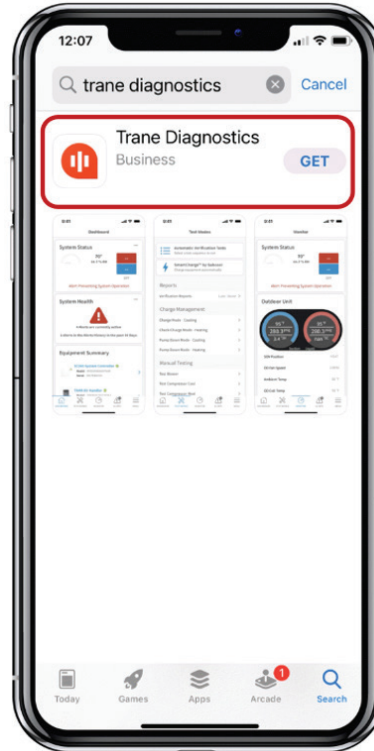

### American Standard Diagnostics App

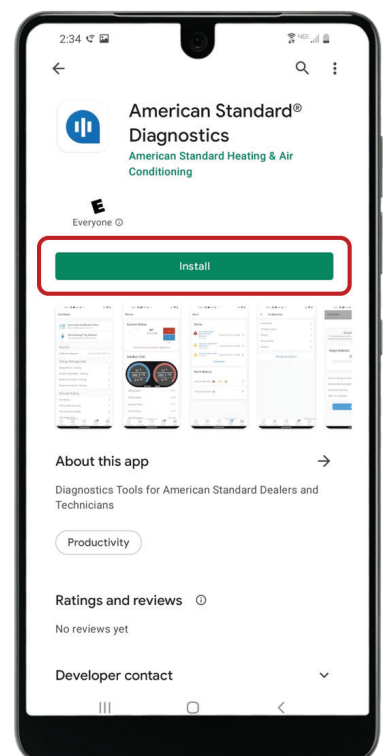
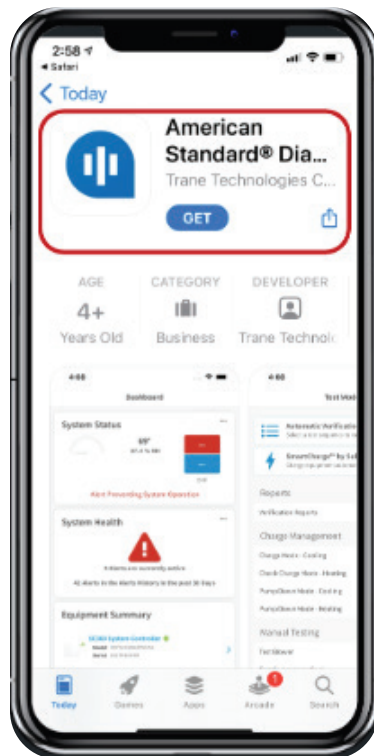

## 7.2 LOGIN to the App:

1. Use your ComfortSite username and password to log in to the app.

2. If you do not have ComfortSite access, contact your dealer admin or support@comfortsite.com for help.

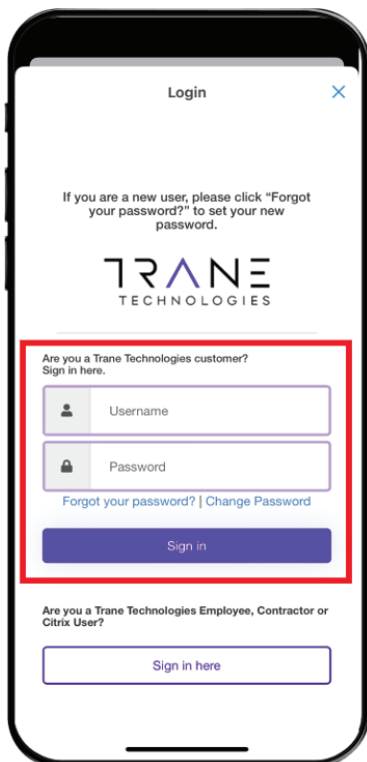
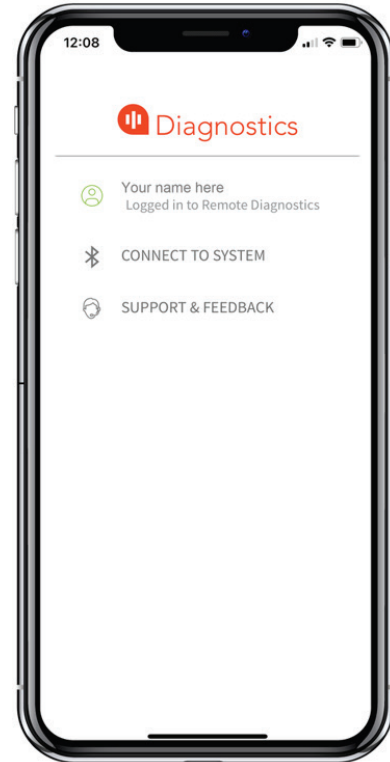
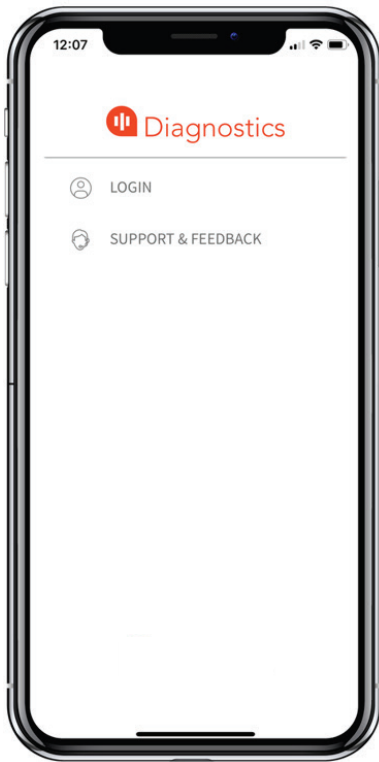

## 7.3 Connecting to a Link System:

1. Enable connectivity on the homeowner's Trane Link Smart Thermostat or American Standard Smart Thermostat.

**NOTE:** This action may not be required for new system installation.

2. Select "CONNECT TO SYSTEM" on the mobile application.

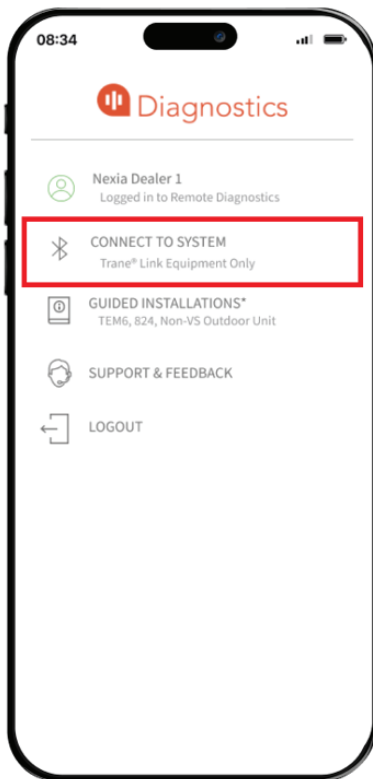

3. Select the equipment to connect.

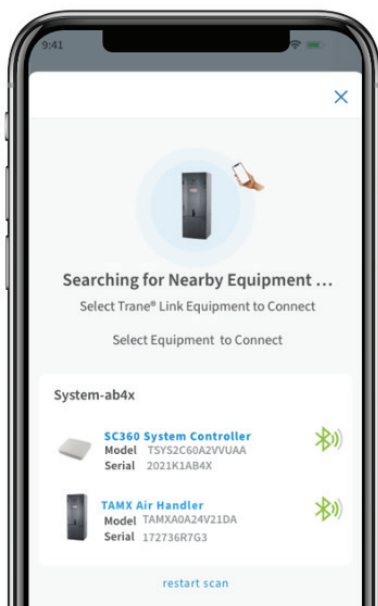

4. Select "Next" for setup assistant.

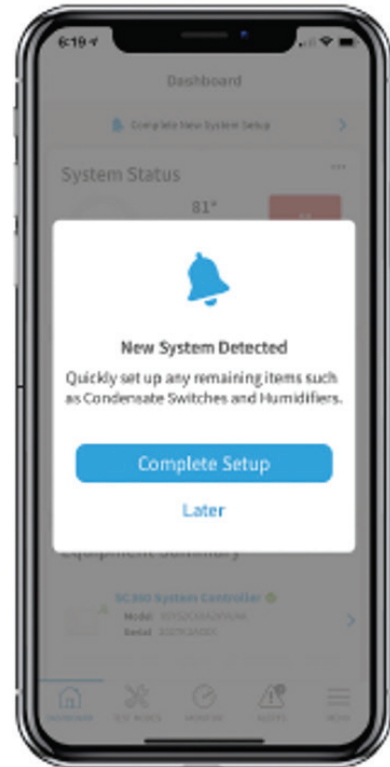

5. Follow the prompts and complete each category as required.
6. Your newly connected equipment should appear on the dashboard under "EQUIPMENT SUMMARY" once you have completed the setup process.



### 7.4 Zoning Configuration:

Access Zoning Configuration by pressing “Zoning” from the Configuration menu.

Follow the same commissioning steps in the app that you would from the thermostat:

2. Select dampers automatically or manually.
3. Select “Run Auto Zone Sizing”.

**NOTE:** Automatic Zone Size Mode is preferred.

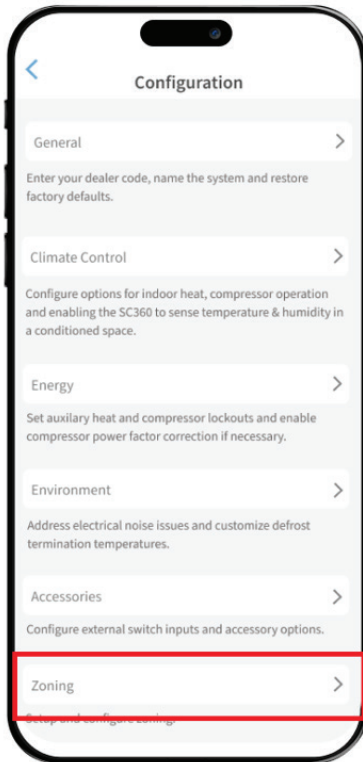

1. Enable zoning.

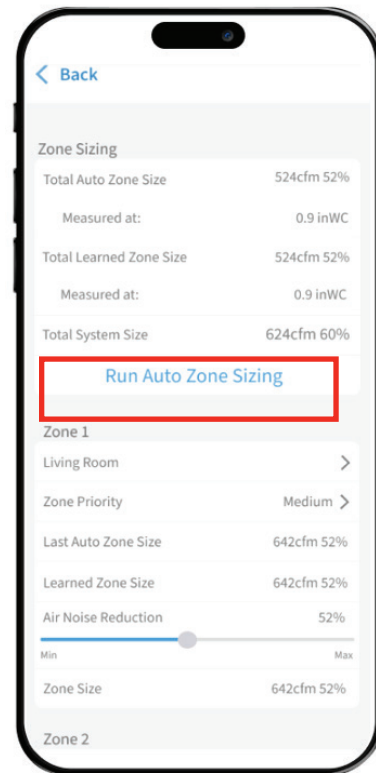

4. Assign zone sensors.

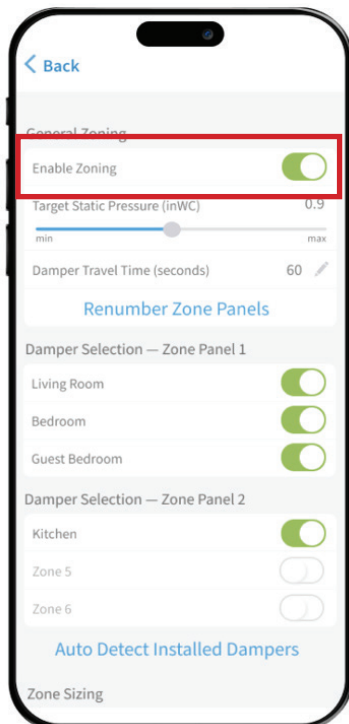

## 7.5 Support & Feedback tab:

The Support & Feedback tab within the tech app provides short videos to support zoning configurations, assigning sensors and running the airflow test mode.

Refer to the videos for additional support when needed.

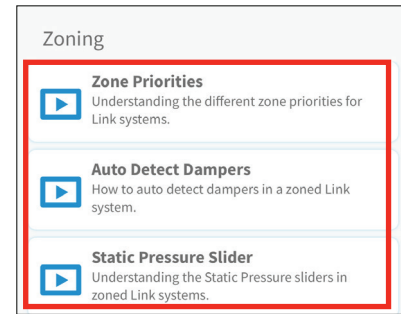
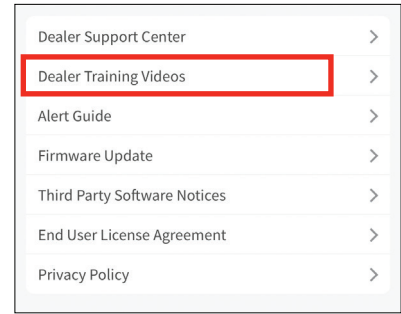
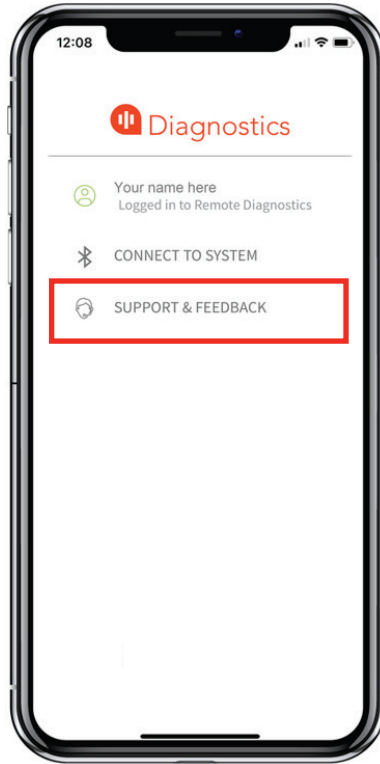

## 8. Link Zoning Commissioning

### Navigate to Zoning Configuration:

Menu > Service > Enter Technician Access > Proceed > Configuration > Zoning

### 8.1 Enable Zoning:

**NOTE:** "Enable Zoning" is toggled to ON automatically when you enter into Zoning Configuration. The default is automatically set to ON.

The Enable Zoning toggle is auto-enabled when Link detects a zone panel on the communicating bus. This toggle can be turned off if needed; such as a new construction house where the zone sensors are not installed yet. If the toggle is turned off without zone sensors configured, the Link system will control system operation as a standard non-zone system and control system capacity from the UX360 thermostat. If this toggle is turned off before zoning is configured and sensors are assigned; then Link will open all dampers and control system capacity from the smart thermostat. If this toggle is turned off after zoning has been configured, then Link will run the system in single-zone mode (see the zone priority segment for single-zone mode details).

### 8.2 Damper Travel Time:

60 Seconds. Cannot be modified.

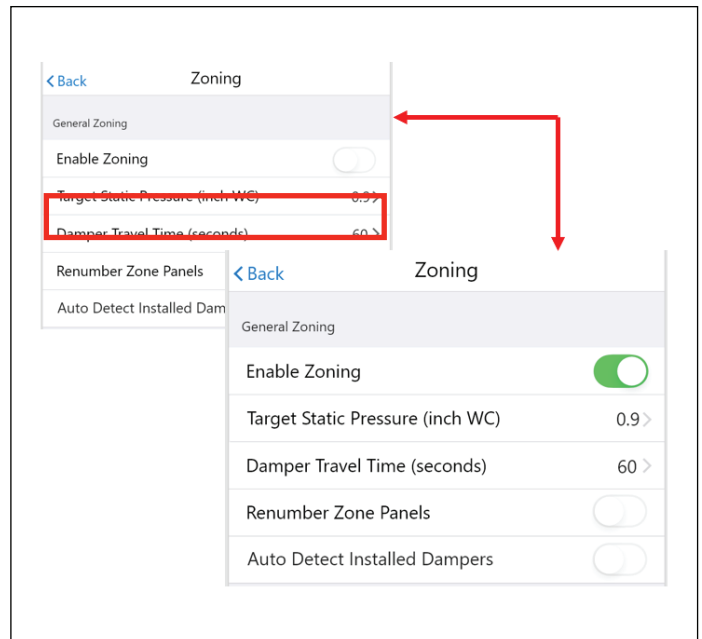

### 8.3 Renumber Zone Panels:

Renumbering zone panels is necessary when there are two zone panels within the system.

If the zone numbers are not correctly auto-assigned to two zone panels, initiate the renumbering of the zone panels **BEFORE** beginning zoning configuration.

The zone panel number LEDs on the two zone panels will be swapped as a result.

#### Renumber Zone Panels:

Link will auto-detect the zone panels that are wired into the communicating bus and auto-discover zone panel numbers.

Link will auto-discover based on a first come / first serve basis. The first zone panel that responds to a Link communication message is Zone Panel 1.

The other zone panel will be Zone Panel 2. If there is only one zone panel in a system, it will be detected as Zone Panel 1.

- Zone Panel 1 controls zones 1 through 3
- Zone Panel 2 controls zones 4 through 6

Each zone panel will have a series of LEDs for communication and zone panel numbering.

- The COMM LED will flash the number of devices on the communication bus
- The Zone Panel 1 LED is a white LED (bottom left image)
- The Zone Panel 2 LED is a blue LED (bottom right image)

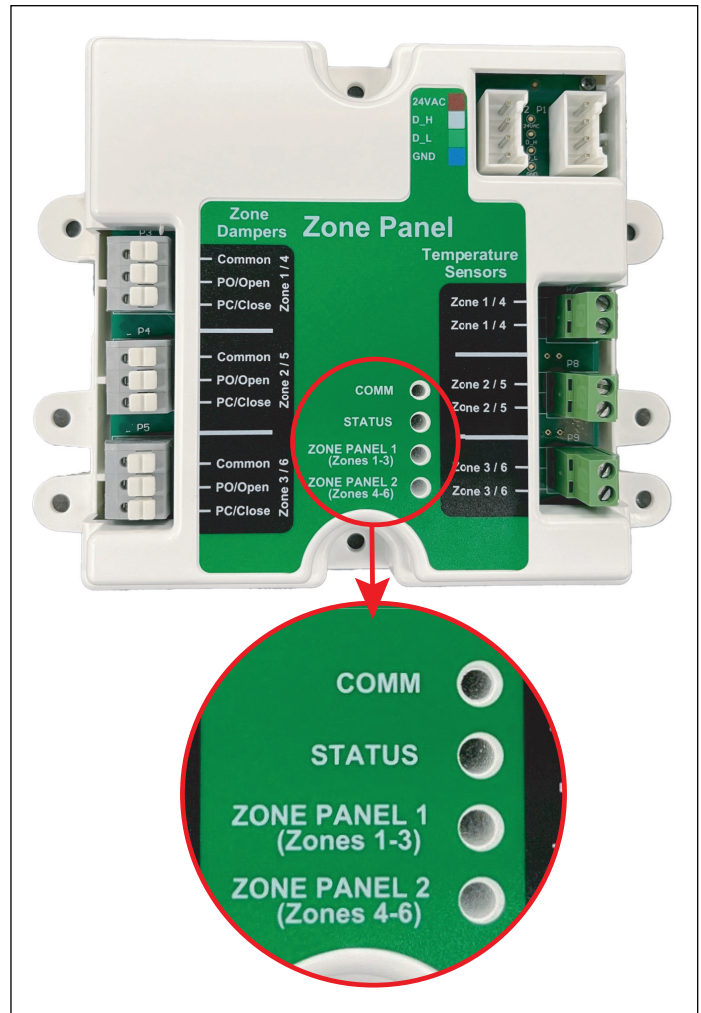

**These LEDs are bright and can be seen at a distance for easy viewing.**

Zone renumbering has no impact on system operation or zone names. It only swaps the zone numbering from one panel to another.

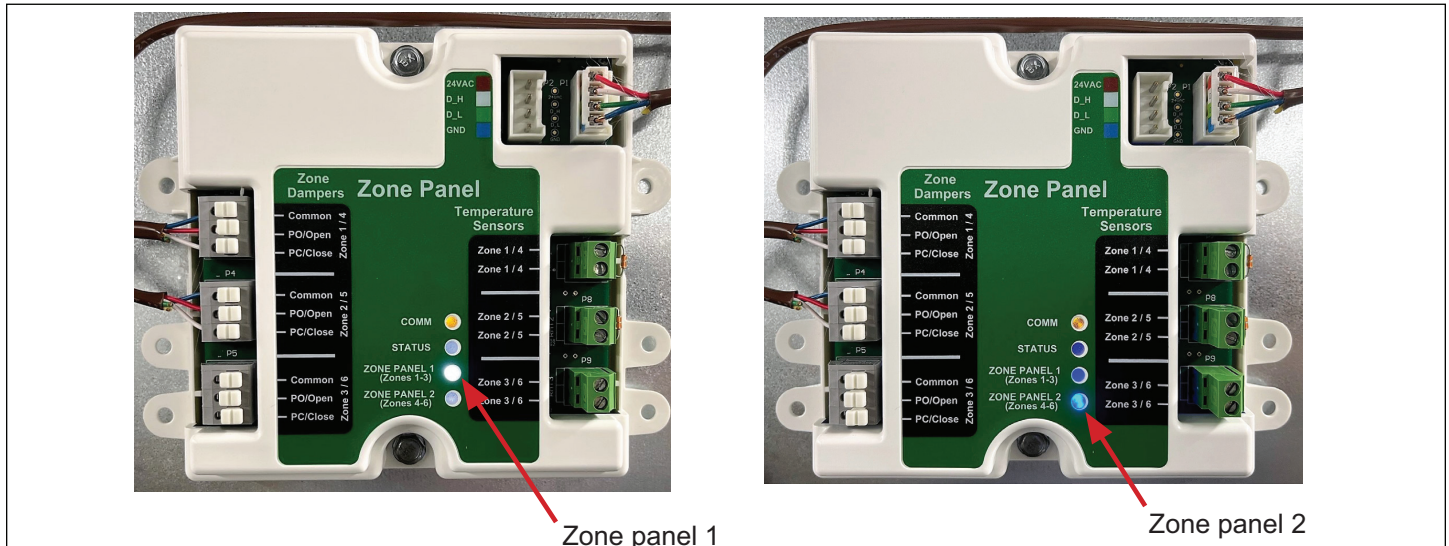

# Installation Guide

- If the arbitration of the zone panels are reversed from the desired numbering, then press the “Renumber Zone Panels” button before proceeding with zoning configuration.
- Link will ask if you wish to renumber zone panels. Confirm by pressing the blue button to “Switch Zone Panels” or select the option for “No Change”.
- If proceeding to switch, Link will take a few seconds to renumber the zone panels and you will see the LED indicators move positions as shown below.

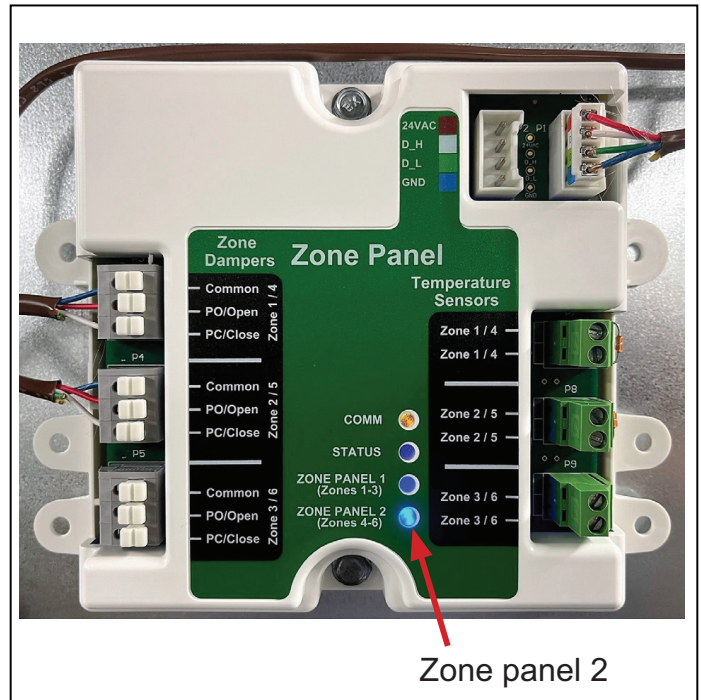
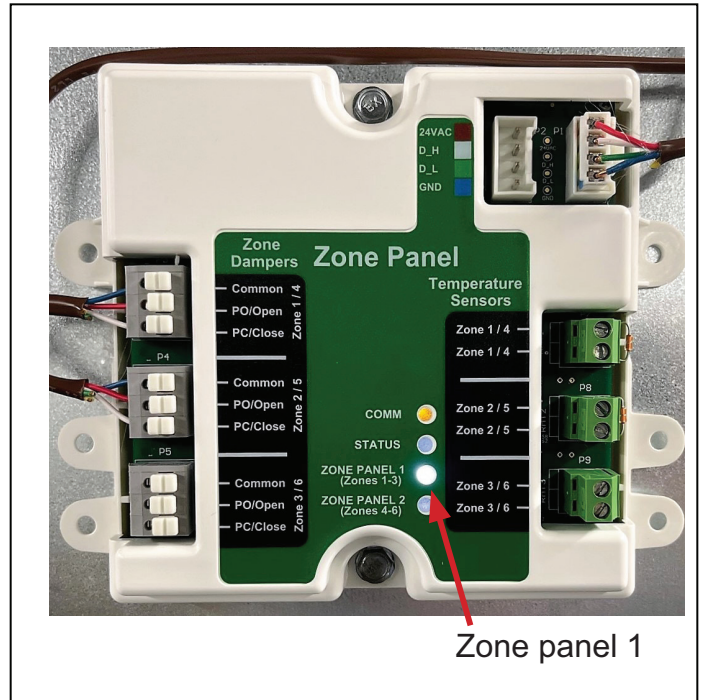

Configuration Zoning

General Zoning

Enable Zoning

Target Static Pressure (inch WC) 0.9

0.7 1.3

Damper Travel Time (seconds) 60 >

**Renumber Zone Panels**

Verify the LED on each zone panel is highlighted correctly next to the corresponding zones.

Are your zone panels numbered correctly?

Verify the LED on each zone panel is highlighted correctly next to the corresponding zones.

**Switch Zone Panels**

No Change

### 8.4 Damper Selection:

#### Auto Detect Dampers:

For Zone systems, Select “Auto Detect Installed Dampers” to have the system detect the dampers attached to the system or enable individual dampers by toggling the button to ON next to the corresponding zone number. Each zone can be assigned a predefined or custom name.

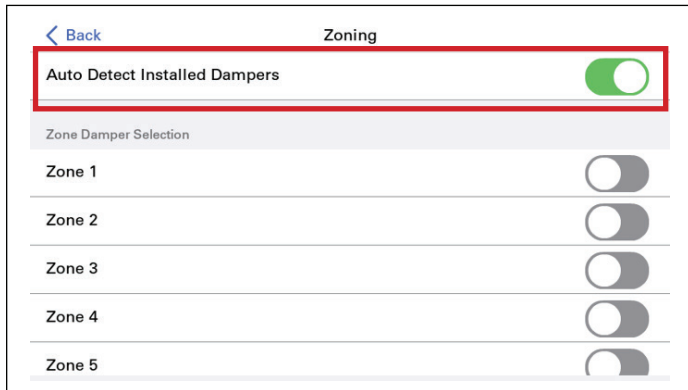

This can be done now or later in the process.

- With two-zone panels, ensure the panels are numbered correctly before assigning dampers.
- Once confirmed, Link has the ability to search for and auto-populate dampers that are installed in the system.
- To enable a zone, the damper must be toggled on.
- This can be done manually or through auto-damper detection.
- When pressing the Auto Detect Installed Damper button, the zone panel will send voltage to the power open wire and sense current flowing between power open and common.

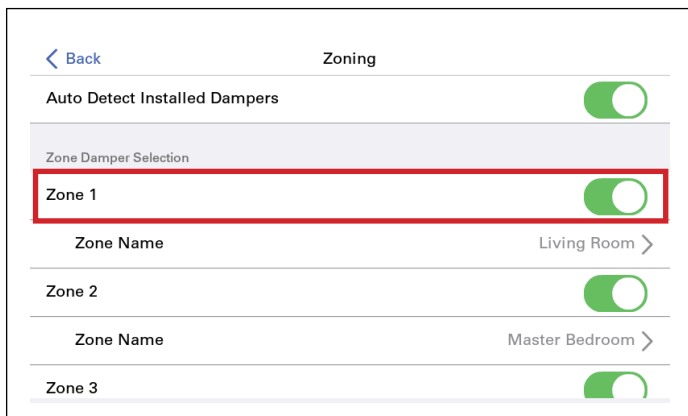

- If current is sensed, the circuit is complete, and Link will auto-enable that zone as having a damper.
- If current is not sensed, then the toggle to that zone will remain off.

#### Naming Zones:

1. Select the current Zone Name to access a keyboard.



2. Enter a new zone name.

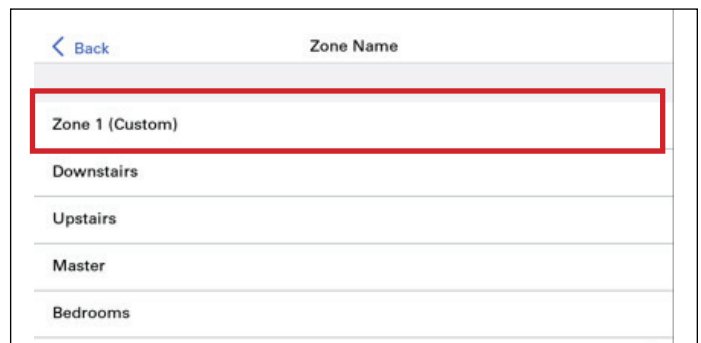

3. Press **Done** to save the changes and return to the previous screen.

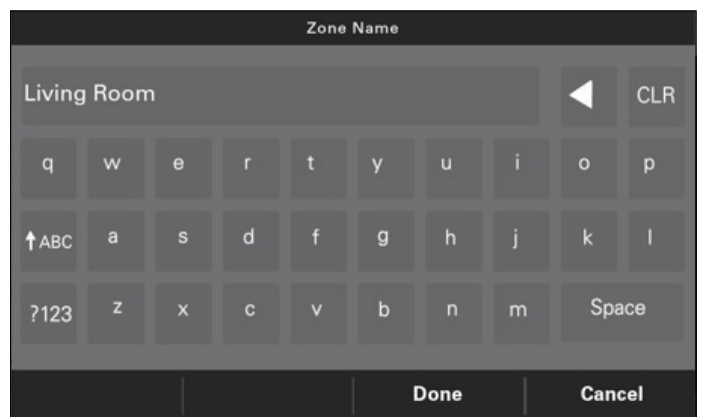

### 8.5 Zone Sizing & Auto Zone Sizing:

Auto zone sizing is required with Link zoning.

Press “Zone Sizing” button to proceed to with zoning configuration and auto Zone Sizing.

**IMPORTANT: Auto Zone Sizing must be completed before zoned operation in either mode is allowed.**

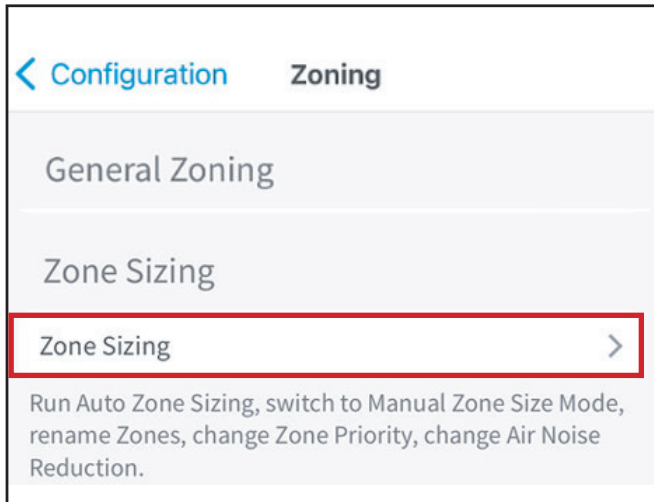

The zone sizing table will be empty on a new installation. The zone sizes in CFM and percentages will all be “- -”. The “Measured at:” provides available static pressure options for auto zone sizing.

The target static defaults to 0.9 inches of water and can be modified from a target static of 0.7 to 1.3 inches of water.

Zone Sizing		
Max Required System Airflow	-- CFM	-- %
Total Auto Zone Size	-- CFM	-- %
Measured at:	0.9 inWC	
Total Learned Zone Size	-- CFM	-- %
Measured at:	0.9 inWC	
Total System Size	-- CFM	-- %
<a href="#">Run Auto Zone Sizing</a>		

Selecting a lower static of 0.7 or 0.8 will calculate zone sizes for lower air flow velocity rates and quieter operation.

Individual zone sizes and total system size will be smaller at lower static targets.

Selecting a higher stat of 1.0 to 1.3 will calculate zone sizes with higher airflow velocity rates and possibly nosier operation.

Individual zone sizes and total system size will be larger at these higher static targets.



Once auto zone sizing completes, it will populate CFM and airflow percentages for the individual zones and overall system. It's important to understand the definitions for each category.

Max Required System Airflow is the larger compressor airflow or gas heat airflow.

For example:

- 3-ton outdoor unit = 1200 CFM (outdoor unit tonnage \* 400 CFM per ton)
- S8V2C100M5P = 1650 CFM (second stage gas heat default airflow)
- The Max Required System Airflow is the higher of the two: 1650 CFM

Zone Sizing		
Max Required System Airflow	1650 CFM	138%
Total Auto Zone Size	2004 CFM	167%
Measured at:	0.9 inWC	
Total Learned Zone Size	2004 CFM	167%
Measured at:	0.9 inWC	
Total System Size	2004 CFM	167 %
<a href="#">Run Auto Zone Sizing</a>		

When an outdoor unit is detected, Link will use the outdoor unit for the baseline airflow. All airflow percentage calculations are based on the outdoor unit airflow.

Furnace airflow divided by outdoor unit baseline airflow = 138% (1650 / 1200).

**IMPORTANT: The total auto zone size & total system size must be equal to or greater than the max required system airflow.**

The max required system airflow on a 3-ton outdoor unit with air handler would be 1200 CFM.

Heating	Airflow Setting	Target Airflow	
Heating 1st Stage	Low	979	CFM
			Temp. Rise
			Watts
	Medium Low	1080	CFM
			Temp. Rise
			Watts
	Medium <sup>(a)</sup>	1188	CFM
			Temp. Rise
			Watts
	High	1296	CFM
			Temp. Rise
			Watts
Heating 2nd Stage	Low	1360	CFM
			Temp. Rise
			Watts
	Medium Low	1500	CFM
			Temp. Rise
			Watts
	Medium <sup>(a)</sup>	1650	CFM
			Temp. Rise
			Watts
	High	1800	CFM
			Temp. Rise
			Watts

Once auto zone sizing completes, it will populate CFM and airflow percentages for the individual zones and overall system. It's important to understand the definitions for each category.

**Total Auto Zone Size CFM** shows how much airflow the duct system can deliver based on the static pressure slider target.

**Total Auto Zone Size %** is the relationship between nominal airflow and the auto zone size results. Auto zone size must be at least 100% or larger for zoning to be enabled.

**Total Learned Zone Size** is learning through time. This is not used to calculate air distribution or manage excess air.

**Total System Size** is the sum of all the individual zones and is influenced by the air noise-capacity reduction sliders. If all air noise sliders are left at 100%, then Total System Size will equal the Total Auto Zone Size.

**Press the Run Auto Zone Sizing button to begin the auto zone sizing process.**

The Diagnostics app and thermostat will have a count down timer for how many minutes remaining. This image is the start of a 4-zone system.

- A 3-zone system takes approx. 5 minutes to complete.
- A 4-zone system takes approx. 7 minutes to complete.

Zone Sizing		
Max Required System Airflow	1650 CFM	138%
Total Auto Zone Size	2004 CFM	167%
Measured at:	0.9 inWC	
Total Learned Zone Size	2004 CFM	167%
Measured at:	0.9 inWC	
Total System Size	2004 CFM	167%
<a href="#">Run Auto Zone Sizing</a>		

Auto zone sizing learns the duct model based on blower static.

Link recognizes airflow restrictions such as refrigerant coils, hydronic coils, heat strips, air cleaners, and anything that is placed in the duct system.

Link uses true blower static, and it knows total blower static only, it does not know the relationship of return and supply static.

Link will assume they are relatively equal in pressure drop. If auto zone sizing calculates a marginal zone size that is less than 110% of nominal air flow, then Link will re-proportion the static pressure of the return and supply; shifting a higher percentage of the pressure drop to the supply duct.

Link will not enable zoning if auto zone sizing calculates a total system size of less than 100%. In these instances, evaluate duct restrictions and make repairs to reduce the restrictions, which may require increasing duct sizing or possibly adding additional ducting to reduce the airflow restrictions. Link will not enable zoning if any individual zone size is less than 5% in size. Zone sizes less than 5% are often representative of an improperly wired zone damper, where power open and power close may be reversed. For marginal total zone sizes below 110%, it's recommended to increase target static by 0.1 increments and reevaluate total auto zone size and individual zone sizes. There is an opportunity to adjust individual zone sizes through an air flow - capacity reduction slider in the configuration menu as well as the zone air flow test mode.

Once auto zone sizing is complete and individual zone sizes are adjusted, evaluate the zone sizes in relation to the min airflow requirements. Zone sizes that are smaller than the minimum system capacity could generate relief. Variable speed compressor operation (HP heating and cooling) tends to have the best airflow turn-down ratios and minimize the risk of excess air conditions.

### Steps to fully commission zoning:

1. Enable zoning.
2. Select dampers automatically or manually.
3. Run auto zone sizing.  
**NOTE:** *Automatic Zone Size Mode is preferred.*
4. Assign at least 1 sensor for each active zone: UX360 / Wired / Wireless.

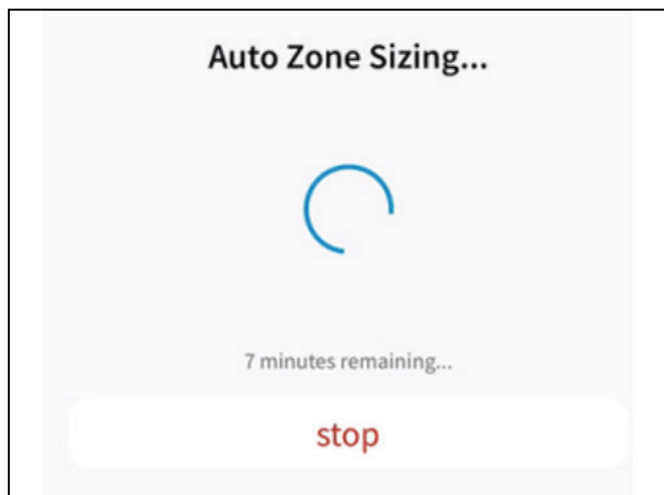

## 8.6 Zone Priority:

**Each zone must have a zone priority. The priority sets the level of importance for the zone.**

- A living room or bedroom may be a high priority; a zone where comfort is most critical.
- A part-time office may be a medium priority; a zone that is used regularly, but for shorter periods. Comfort in this zone is important, but not as critical as the main bedroom.
- A guest room, storage room, or basement may be low-priority zones; these zones may be rarely used.
- All zones default to medium priority
- All zones cannot be set to low; at least one zone must be set to medium or high.

Zone priorities influence system operating mode, system capacity, and the management of excess air.

- A non-voting zone cannot control capacity
- Zones less than 25% in size are non-voting zones

Link uses zone priority rather than voting. A zone that is set to a low priority cannot call for system capacity if it creates excess air (non-voting). A low-priority zone can request capacity and energize system operation if it does not create excess air.

Medium and high-priority zones can energize system operation; even if excess air is generated. Zone priorities influence system

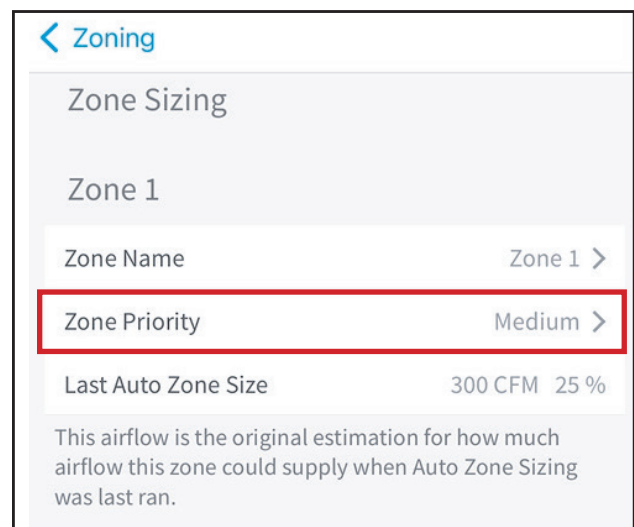



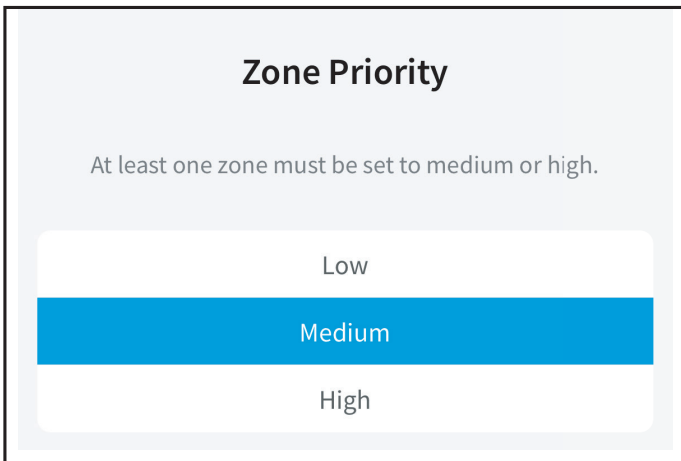

mode of operation. A low-priority zone cannot change system mode of operation. In mild conditions; it's possible for a system to heat in the morning and cool in the afternoon. Zones set to medium or high priority are able to shift system operating modes when needed; whereas low-priority zones cannot. Zone priorities also influence relief air calculations.

**Zone priorities influence non-zone and single-zone operation.**

Non-zone operation occurs when zone panels are installed but zoning is not fully configured (sensors have not been assigned to all zones).

Link will use the smart thermostat to control system capacity in non-zone operation.

Single-zone operation requires zoning to be enabled.

Zone configuration must be complete, and each zone must have an assigned zone sensor.

**Zoning can be disabled for several reasons:**

Turning the Enable Zoning toggle turned off, a zone panel failure (zone panel goes offline), a zone sensor failure (where a zone cannot sense temperature), or a zone panel relay failure.

If any of the above conditions occur that forces the disabling of zoning, then Link single-zone mode will:

- Evaluate which zones have sensors that are reporting temperature and humidity. A failed zone sensor is not allowed to control system operation.

- Once the list of reporting zone sensors is determined, Link will look to the highest priority zones for system control. If there are no high-priority operational sensors, Link will look to medium-priority zones for sensor control. If there are no medium-priority zones with functional sensors, Link will look to low-priority zones for system control.
- If there are multiple reporting sensors that fall within the priority grouping noted above, Link will evaluate zone size. The largest size zone with the highest priority will be the controlling sensor.
- If there are two sensors with the same size & same priority level, then Link will choose based on zone numbering (zone 1 would be selected over zone 2).

This sensor will be the controlling sensor for system operation until the zoning failure is resolved. Once the zone failure is resolved, Link will return to normal zone operation. All zone information, such as name, size, priority, and schedules will be returned to their previous settings.

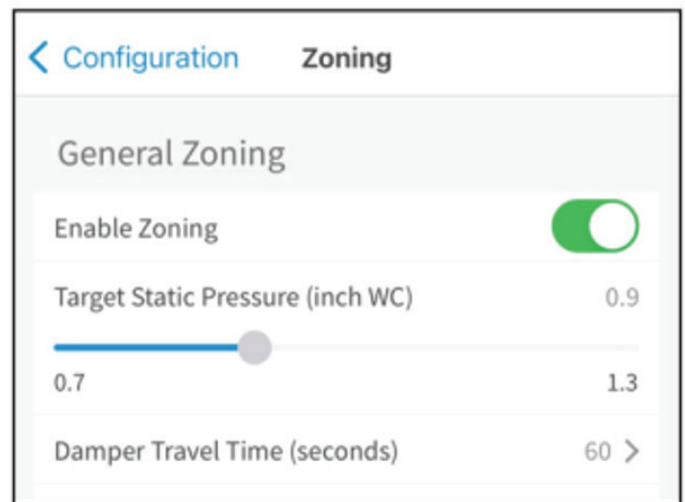

## 8.7 Air Noise-Capacity Reduction:

The Air Noise - Capacity Reduction slider is found in the configuration menu and zone airflow test mode screens.

The slider defaults to 100% and the zone size will match the Last Auto Zone Size. If auto zone sizing populates a zone size that is significantly larger than the duct design, the noise slider can be moved to reduce this individual zone size instantly. Adjusting the slider in the menu will not deliver blower operation. It's an instant adjustment to the zone size. Reduction in zone sizes will also be reflected in the Total System Size.

In this example, the air noise-capacity reduction slider has been adjusted down to 75%.

This slider will not influence the last auto zone size.

The last auto zone size will remain "as is" for a reference point.

This slider will only influence the Zone Size and Total System Zone size.

**IMPORTANT: It is important to evaluate individual zone sizes in relation to the system being installed.**

**NOTE: If the Zone Sizes for one or more zones are very small, check for reversed PO and PC wires for one or more dampers in that zone.**

Zone sizes that are smaller than the min system capacity can cause excess air.

If the zone sizes are much smaller and much larger than expected in two or more zones, check for the PO and/or PC wires connected to the Common output in one or more zones.

The screenshot shows the 'Zoning' configuration menu. At the top, there is a back arrow and the word 'Zoning'. Below that is the 'Zone Sizing' section for 'Zone 1'. It lists 'Zone Name' as 'Zone 1', 'Zone Priority' as 'Medium', and 'Last Auto Zone Size' as '300 CFM 25 %'. A note states: 'This airflow is the original estimation for how much airflow this zone could supply when Auto Zone Sizing was last ran.' Below the note, it shows 'Learned Zone Size' as '300 CFM 25 %'. The 'Air Noise - Capacity Reduction' is highlighted with a red box and set to '100 %'. A slider below it is positioned at the 100% mark, with '50 %' on the left and '100 %' on the right. At the bottom, 'Zone Size' is listed as '300 CFM 25 %'.

The screenshot shows the 'Zoning' configuration menu with 'Air Noise - Capacity Reduction' highlighted in a red box and set to '75 %'. The slider is positioned at the 75% mark. The 'Learned Zone Size' is '300 CFM 25 %' and the 'Zone Size' is '228 CFM 19 %'.

### 8.8 Zone Details:

**Individual zone data:** Each zone will provide airflow performance, configuration options, and the ability to name the zone.

#### Zone Name

Defaults to the zone number. Press the Zone Name field to modify the zone name.

Select a name from a preset drop-down list or customize a name if needed.

#### Zone Priority

Customizable setting to specify each zone relative priority within the calculations for control of the zone capacity and comfort. Zone Priority will be covered in greater detail in the next segment.

**NOTE:** *The Zone Priorities cannot all be set to Low.*

#### Last Auto Zone Size

Auto zone sizes per zone at the current Target Static Pressure setting. In Manual Zone Size Mode, the auto zone sizes are for reference when setting the Manual Zone Sizes.

Last Auto Zone Size will be shown for each zone.

Link will use this number for airflow/capacity distribution and calculating excess air.

Changes to the static pressure slider will be reflected here without having to run auto zone sizing again.

#### Learned Zone Size

Learned zone sizes per zone at the current Target Static Pressure setting. Used for capacity calculations for control of comfort in the zones. However, the Auto zone sizes determine the maximum airflow to each zone.

The Learned Zone Size will initially calculate the same as the auto zone size, but this will change relatively quickly, and the changes can be dramatic. The auto zone size test is quick and relatively accurate, but Link will continually evaluate airflow performance through time and make adjustments to the learned zone size.

**NOTE:** *Learned zone sizes will change as the filter loads with dirt and is later replaced with a clean filter. Learned zone sizes will also change based on the frequency of the calling zones. If a 4-zone system has a basement zone that never calls for capacity through the summer season, then Link will be learning the dynamics of a 3-zone system, and learned zone sizes will change for all zones. Airflow through individual zones is very dynamic and constantly changing. Link constantly captures this and adjusts these calculations in learned sizing.*

Zone Sizing	
Zone 1	
Zone Name	Bedroom >
Zone Priority	Medium >
Last Auto Zone Size	400 CFM 33%

#### Air Noise – Capacity Reduction

Customizable slider for addressing noise issues on a per zone basis. Can be set from 50% to 100% of Nominal Indoor Airflow. Air noise reduction will be covered in greater detail later.

#### Total System Size

The sum of all the individual zones and is influenced by the air noise - capacity reduction sliders after pressing the Save Adjustments button.

## 9. Zone 1 Sensor Setup

### Navigate to Zone 1 Sensor Selection:

Menu > Service > Enter Technician Access > Proceed > Configuration > Climate Control

On the Climate Control screen, scroll down to the **Sensor Priority** Section.

### Zone 1 Primary Sensor

- The default primary sensor is the Smart Thermostat.
- To make a change, select Zone 1 Primary Sensor.
- Select the desired “Primary Sensor” for zone 1 and then select “Back”.

### Zone 1 Backup Sensor

- The default “Backup Sensor” is the Return Air Sensor.
- To make a change, select the desired backup sensor for zone 1 and then select “Back”.

### Available Sensors:

- Thermostat
- Return Air
- System Controller\*

\* System Controller must be installed in conditioned space.

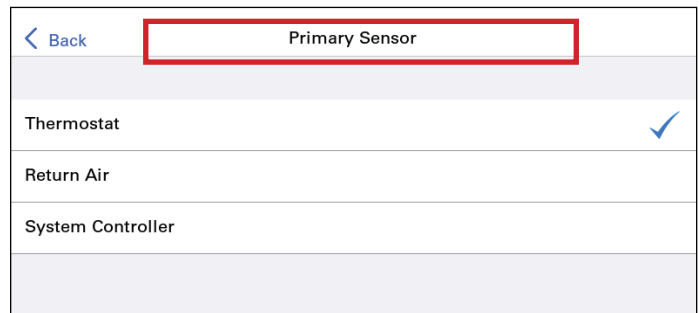
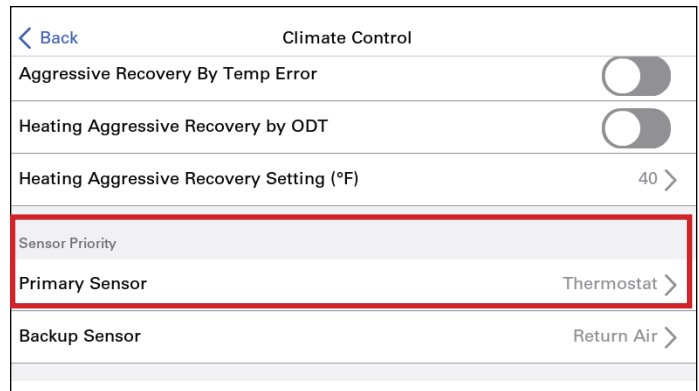

## 10. Sensor Assignment

### 10.1 Indoor Sensor Setup:

After Zoning Configuration is complete need to assign the sensors to the individual zones.

There are several zone sensor options:

- \*HUI2360A\*\*\* Link Smart Thermostat temperature/humidity sensor (one per system at launch)
- \*SYS2C60A\*\*\* System Controller temperature/humidity sensor (one per system)
- ZSENS930\*\*\* Wireless temperature/humidity sensor (multiple sensors allowed)
- ZZSENSAL0400\*\* Wired temperature thermistor (multiple sensors allowed)

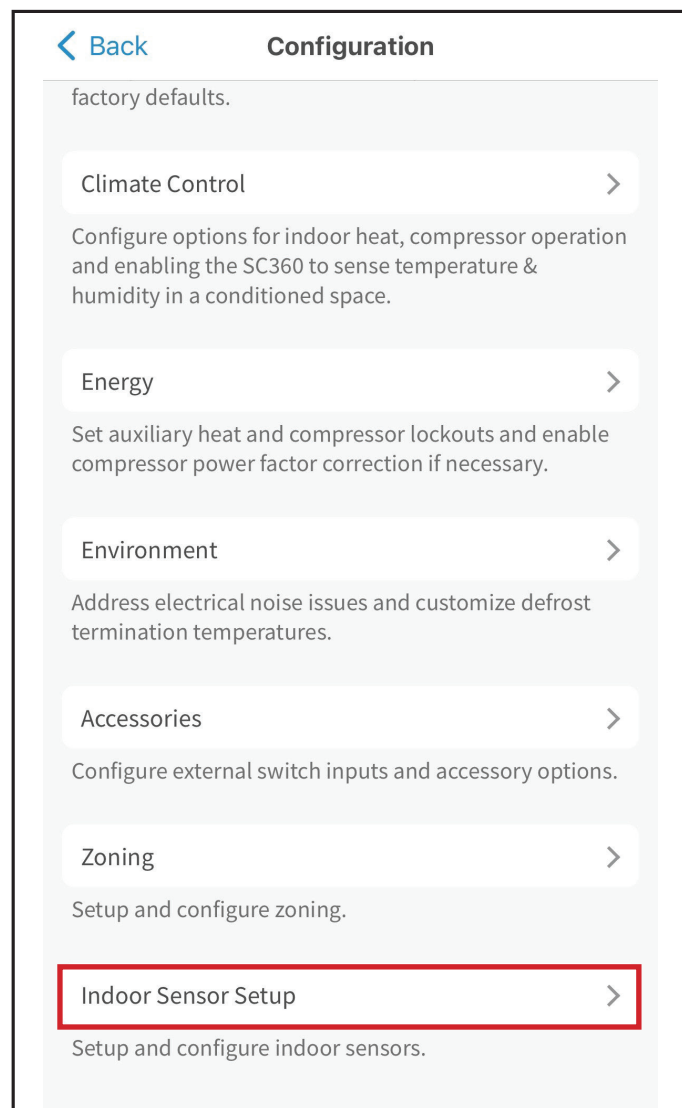

Link will automatically transition to the sensor setup screen when zone configuration is complete. The sensor setup screen can also be found in the main configuration menu.

The Sensor Details screen will show the sensor name, the assigned zone, and if the temperature or humidity options are being used.

In this example, if the sensor is close to a shower room and you only want to sense temperature, but not relative humidity; then turn the toggle for Use Humidity to off.

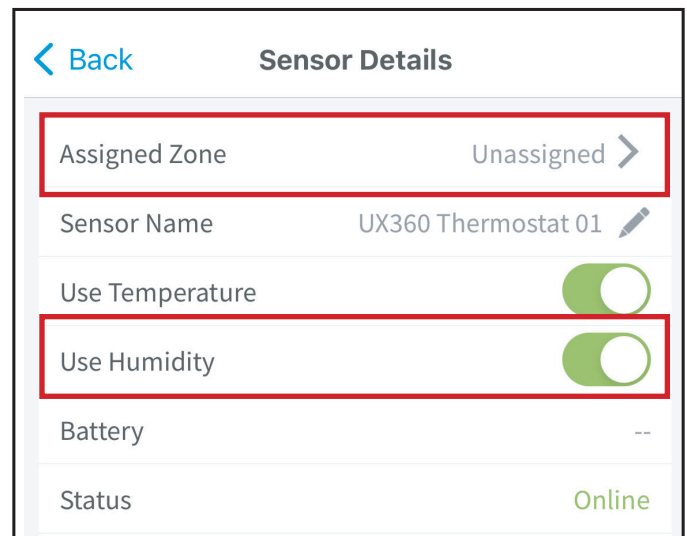

In doing this, **there must be at least one 930 wireless sensors or system controller in the system with relative humidity enabled.**

The sensor details screen will also provide the sensor model number, serial number, and percentage of weight (this is discussed later in this sensor assignment segment).

Click on the top row for **Assigned Zone** to assign the sensor to a zone. Sensors will default to unassigned.

The UX360 thermostat can be assigned to any zone.

For this example, Zone 1 is selected. Press the back arrow to proceed to the assignment of the next sensor.

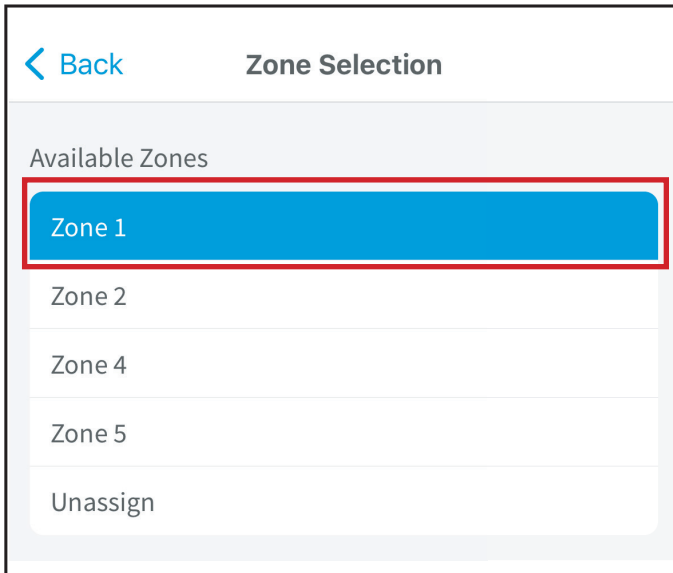

From the indoor sensor setup screen, the “Wired Sensor 01” was selected.

The sensor details screen defaults to “Unassigned” and only has one toggle for temperature.

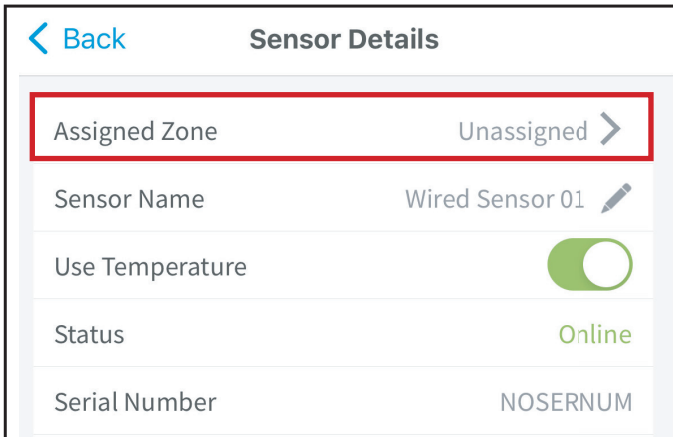

Sensors wired to the zone panel cannot sense relative humidity.

The humidity toggle option is not populated.

Wired sensors will show “Online” as long as they are connected to a zone panel that is communicating on the Link system.

A wired sensor will go “Offline” if the zone panel is offline or if the sensor is out of range (open / shorted condition).

Since wired sensors are physically connected to a zone, Link will only provide an option to assign the sensor to the zone its connected to (or unassign the sensor if needed).

Since this sensor is wired to Zone 1, Zone 1 is the only available option. Continue this process until all wired sensors are assigned.

**NOTE:** A maximum number of four sensors per zone is allowed.

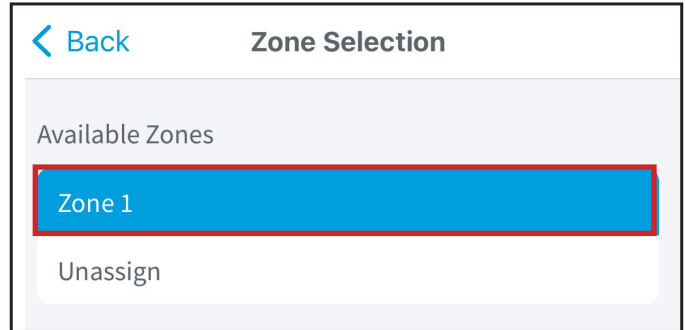

## 10.2 Wireless Sensors:

Reference the 930 wireless sensor video in the support and feedback tab within the tech app for pairing a wireless sensor to a Link system.

Once the wireless sensor is paired, it will populate as an available sensor that must be configured to a zone.

Click on the **Wireless Sensor 1** to see details on the sensor.

The sensor details page provides similar info as the other sensors.

Wireless sensors have a model and serial

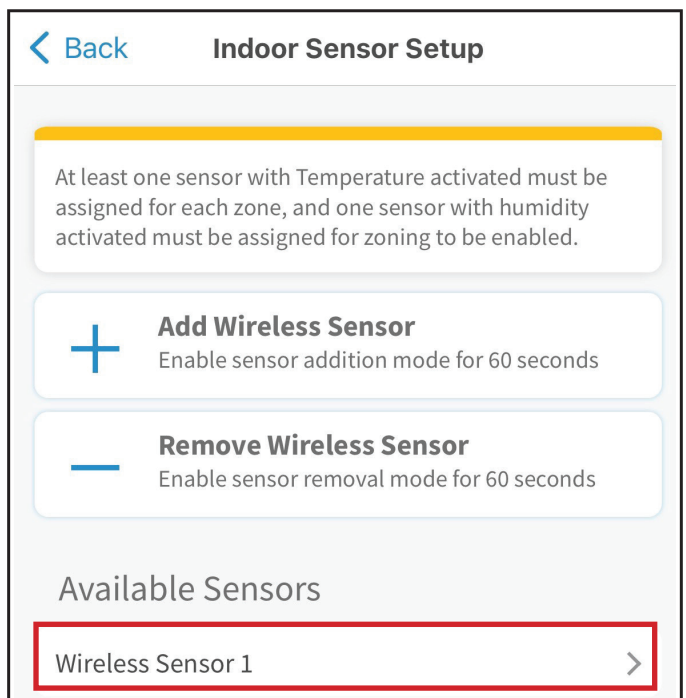

numbers; the serial number is a good reference to ensure each sensor is paired to the correct zone.

Wireless sensors have temperature and humidity sensing capabilities that can be toggled on or off.

Click on the top row to assign the sensor to a zone. Wireless sensors can be assigned to any enabled zone.

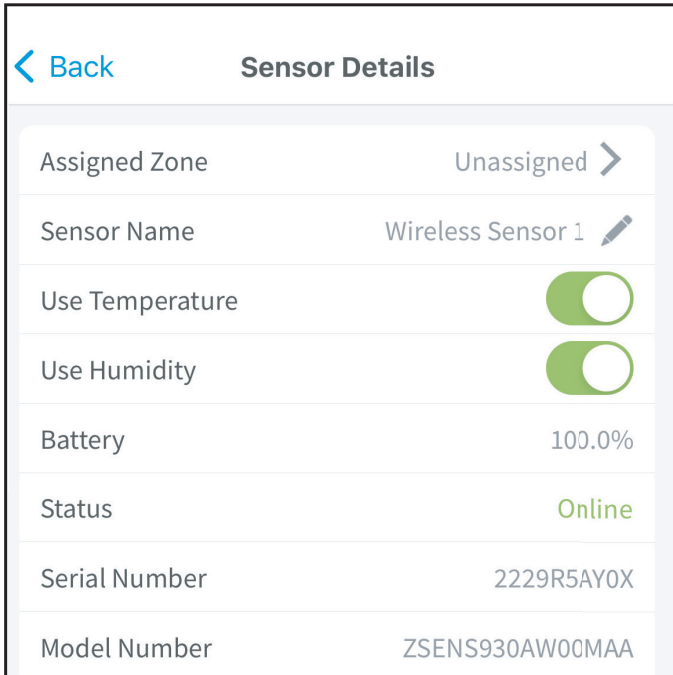

The wireless sensor was paired to zone 1 and there are no other available sensors to assign.

Zone 1 has three sensors that are averaging temperature within this zone; the main thermostat, a wired sensor, and the wireless sensor.

Link will average all three sensors for temperature control. Link will average the thermostat and wireless sensor for humidity control. Enable or disable temperature and humidity for each sensor as desired.

Link will allow up to four sensors to be averaged within each zone.

The system controller (SC360) can also be used as a zone sensor ONLY if it's installed within the zone that is being controlled.

Select the climate control tab from the main configuration menu.

Press the toggle to enable the system controller to control. The toggle will turn green once enabled.

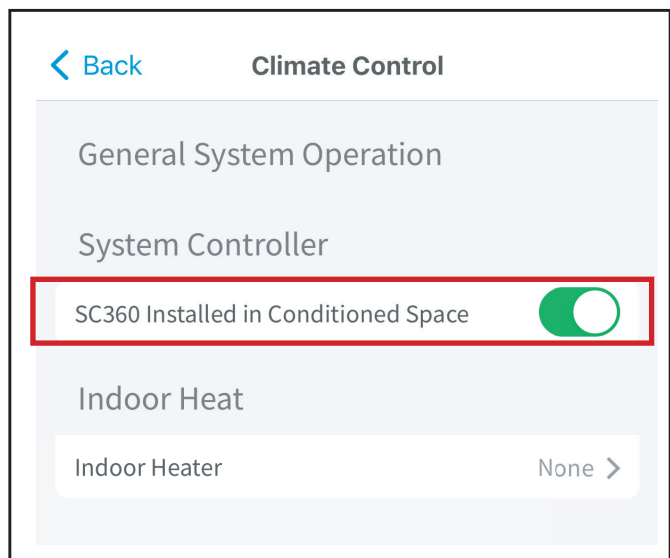
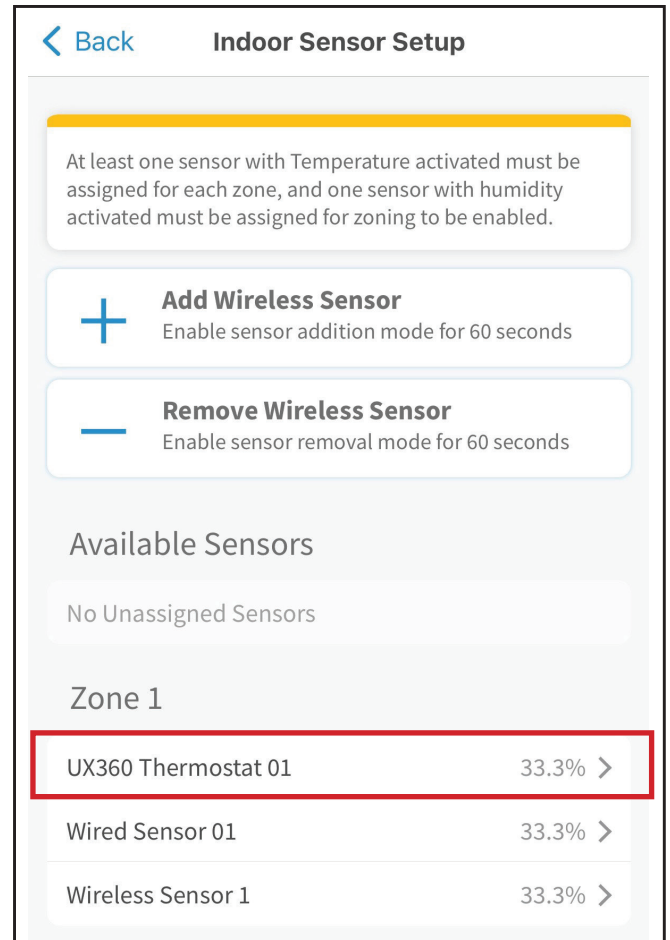

## Installation Guide

- The SC360 System Controller will show up as an available sensor once it is enabled.
- Click on the SC360 to assign it to a zone.
- The system controller has a temperature and humidity sensor, similar to the thermostat. The temperature and humidity toggles default to on but can be toggled off if needed.

The SC360 has been assigned to zone 1.

Zone 1 has a thermostat, wired sensor, system controller, and wireless sensor all averaging the temperature and humidity readings.

Another benefit of multiple sensors per zone is redundancy.

If a zone only has one wireless sensor assigned and the wireless sensor fails (batteries are weak), then Link will enter single zone mode. All dampers will open, and Link will control temperature based on zone priority and zone size. In this example, if the wireless sensor fails, zone 1 still has three sensors to control temperature and comfort. Link will populate a wireless sensor failure alarm and control comfort based on the three remaining sensors. Zoning remains enabled.

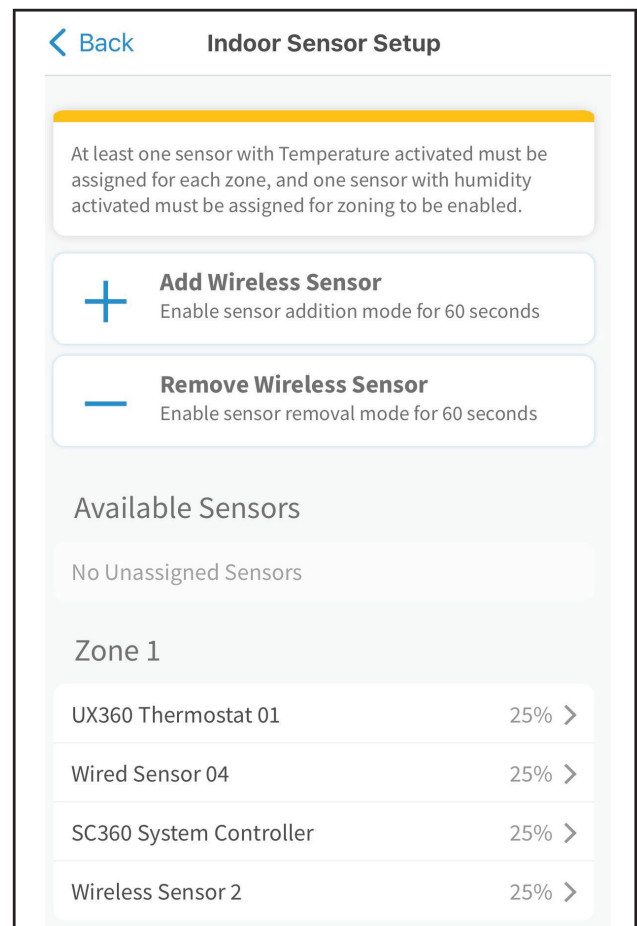
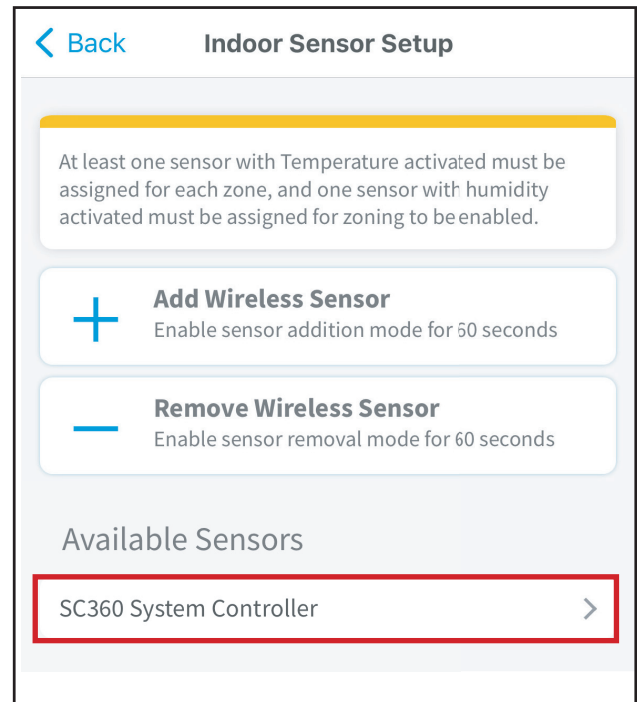



## 11. Zoning Airflow Test

### 11.1 Zoning Airflow Test:

Once zoning configuration is complete and sensors have been assigned, it is recommended to run a zoning airflow test for each zone.

The zoning airflow test is used to verify proper damper wiring, proper damper zone assignment, and proper airflow rates to each zone.

Navigate to the test mode menu and scroll to the bottom to **Test Zoning Airflow**.

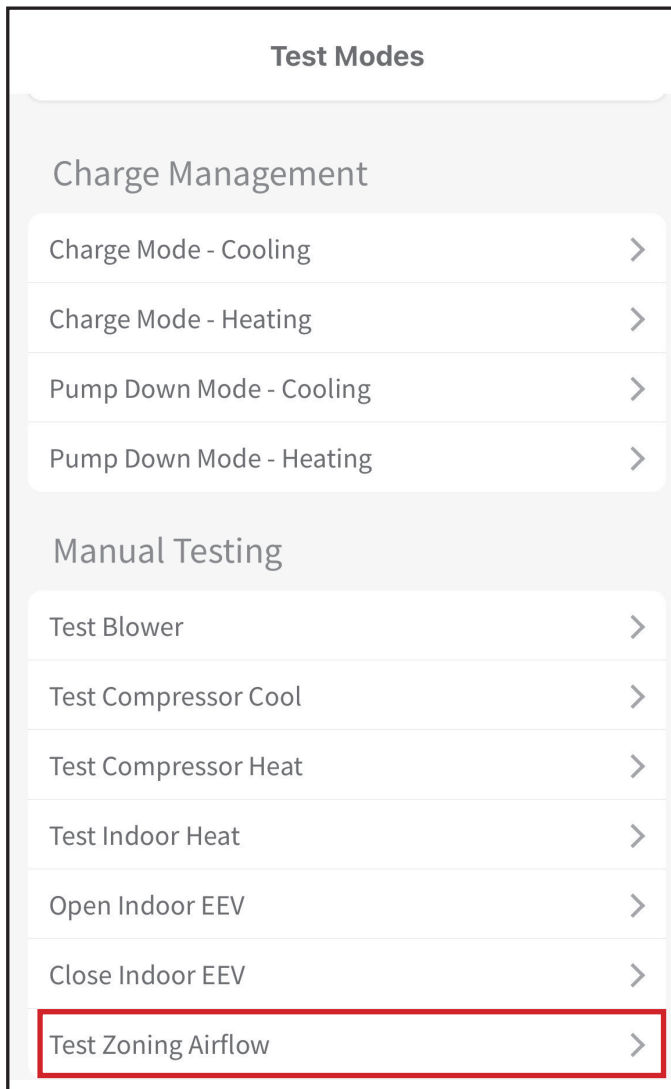

### 11.2 Airflow Test Mode:

The top of the test shows several settings.

**Total System Size** is the sum of all the individual zones and is influenced by the air noise-capacity reduction sliders **after** pressing the Save Adjustments button.

**Adjusted System Size** reflects the updates to system size as the “air noise - capacity reduction” sliders are moved. This will show the difference in Total & Adjusted system sizes as sliders are moved, but not saved.

**Sum of Selected Zones** shows the airflow requested per the zones selected. It’s recommended to select only one zone at a time.

The **Blower Airflow** will match the sum of the selected zones as long as the sum of the zone sizes are within airflow capabilities of the blower.

**Damper Status** will note if the damper is adjusting or in position. Evaluate airflow and air sound once the damper is in position.

The test has a max time of 30 minutes.

Any changes to the test mode, such as selecting another zone to test will reset the timer to 30 minutes.

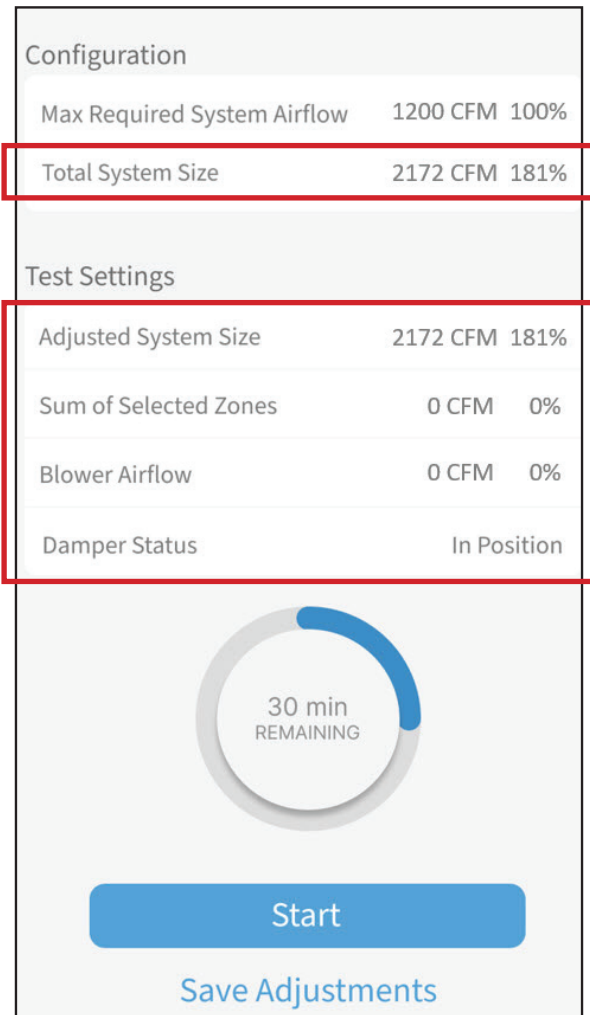

## Installation Guide

Scroll down to see zone sizes for the configured zones. In this example, Zone 1 is 25% in size and toggled on to test.

Link will take the following actions when this test is initiated, and the blower is started:

- Zone damper 1 is driven fully open
- All other zone dampers are driven closed
- The blower airflow will ramp to match the sum of selected zone sizes

**Press the blue Start button to initiate the test.**

This will start the damper movement process.

Another button to **Start** Blower will populate; press the **Start** Blower button and listen to airflow.

Walk through the zones and evaluate airflow.

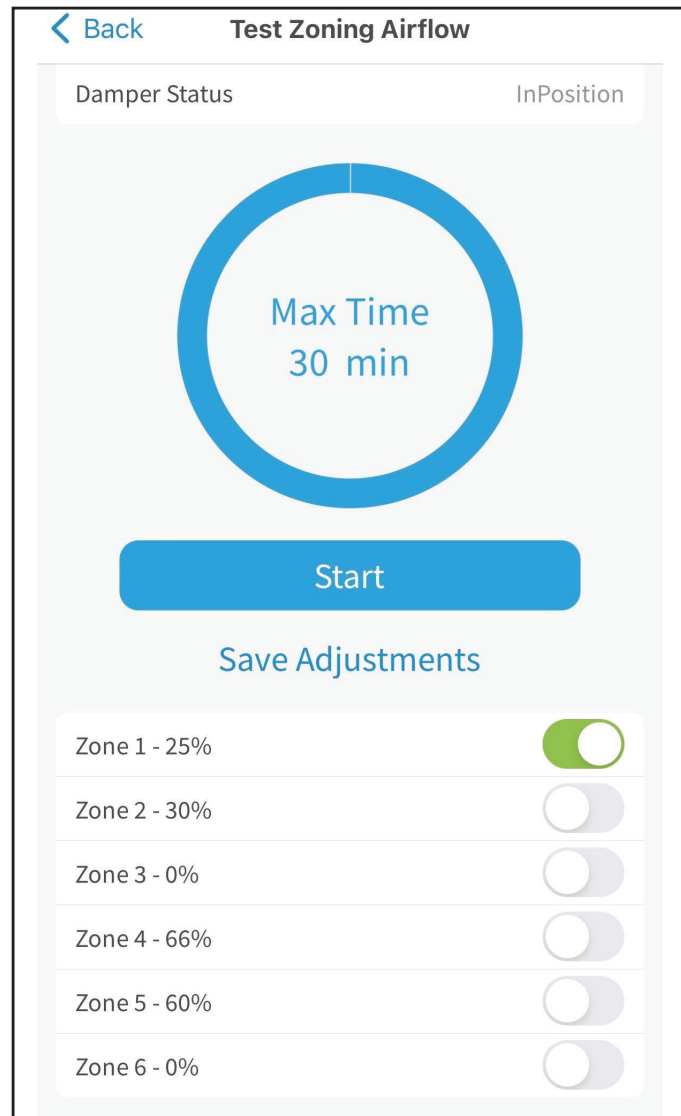

The damper(s) to Zone 1 should all be fully open, and air should be flowing into this zone.

The dampers to all other zones should be closed and there should be no airflow to any other zone.

Repeating this for each zone confirms the following:

- The dampers are moving; opening and closing as they should.
- The dampers are delivering air into the appropriate zone; dampers are not crossed between zones.

Test Settings		
Adjusted System Size	2172 CFM	181%
Sum of Selected Zones	300 CFM	25%
Blower Airflow	300 CFM	25%
Damper Status	Adjusting	

Scroll up at any time to evaluate the sum of the selected zone sizes, the blower airflow, and if the damper is still being adjusted or if it's in position.

In this example, the blower is able to deliver low airflow that matches the 25% zone size.

**Wait for the damper status to change from “Adjusting” to “InPosition” before evaluating airflow patterns.**

This image has a small zone that is only 15% in size. The minimum blower airflow for this 3-ton air handler is 300 CFM, but the zone can only handle 180 CFM at the target static pressure.

Proceeding with this test will deliver 300 CFM into the zone designed for 180 CFM.

Airflow, velocity, and noise will all be excessive. This test will not provide accurate results.

It is recommended to select two small zones that are equal to or greater than the minimum blower airflow of 300 CFM.

Run the airflow test with both zones calling to obtain the typical max airflow into this zone.

This image is representative of all zones being selected.

The sum of the selected zones is the same as the total system size.

The max blower airflow for this 3-ton air handler is 1575 CFM, but the sum of all zones can manage 2004 CFM at the design target static.

Proceeding with this test will deliver lower airflow and lower velocity rates throughout all zones. This test will not provide accurate results.

Remember, properly designed duct systems for zoned installations are based on peak load conditions. Zone duct systems tend to be larger than conventional duct designs and are likely to be larger than the max blower capabilities of the indoor unit.

- Evaluate air delivery rate into each zone. This test verifies there is enough throw at max zone airflow and ensures the velocity rates will not cause a noise complaint.

Configuration		
Max Required System Airflow	1200 CFM	100%
Total System Size	2172 CFM	181%
Test Settings		
Adjusted System Size	2172 CFM	181%
Sum of Selected Zones	2172 CFM	181%
Blower Airflow	1575 CFM	131%
Damper Status	In Position	

Configuration		
Max Required System Airflow	1200 CFM	100%
Total System Size	2172 CFM	181%
Test Settings		
Adjusted System Size	2172 CFM	181%
Sum of Selected Zones	180 CFM	15%
Blower Airflow	300 CFM	25%
Damper Status	In Position	

**There are three primary goals for the airflow test:**

- Ensure each damper is wired properly and operating properly; opening when it should and closing when it should.
- Ensure each damper is delivering air into the appropriate zone. When testing zone 1, airflow should not be felt in any other zone (there is no relief air in the airflow test)

**Physically walk to zone 1 and evaluate airflow.**

If airflow is excessive and noisy, then use the Air Noise - Capacity Reduction slider to reduce the zone size.

Moving the slider to a lower percentage will reduce the size of the zone and lower the maximum allowed airflow to the zone.

The Air Noise - Capacity Reduction slider can only decrease zone size. It cannot increase zone size.

If a zone requires additional airflow, then evaluate duct modifications or increase the target static slider and retest the airflow to all zones.

If air noise is objectionable, then stand in the zone and use the diagnostics app to move the slider and reduce the airflow. If the air velocity rates remain high as the slider is reduced, scroll up to see if the zone size is smaller than the blower airflow.

If so, you will need to select multiple zones for an accurate airflow test.

## Installation Guide

Lowering the slider will reduce the airflow and capacity to the zone; this may cause excess air issues.

Be cautious with marginal duct systems; reducing the slider could cause the total zone size to drop below 100% in auto mode (not allowed).

Lowering airflow will also reduce the capacity to the zone. Evaluate the heat load calculation and ensure the reduced slider setting will still satisfy the zone temperatures.

The test mode provides an opportunity to stop and start the blower when navigating between zones.

Save your adjustment settings when complete.

All adjustments will be ignored and lost if you exit the test without saving adjustments.

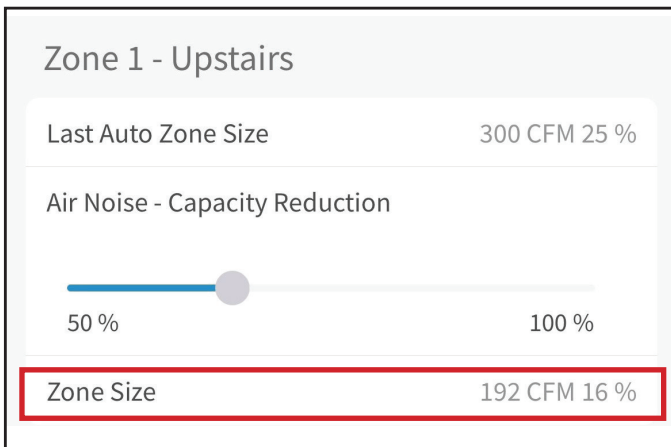
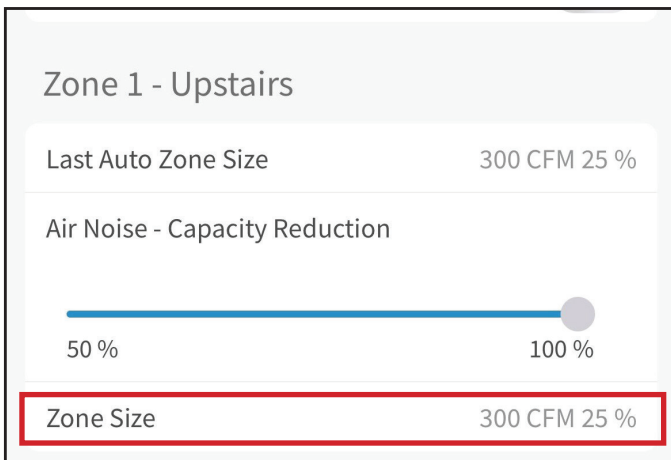

## 12. Zoning Settings and Parameters

Menu Item	Options [Default]	Description
Enable Zoning	Disabled/[Enabled]	Toggle ON (green) to enable zoning. Automatically enabled, set to ON (green), when Zoning Configuration is entered. Toggle OFF to disabled zoning.
Target Static Pressure	[0.9] inch WC	Static pressure can be set from 0.7 to 1.3 Inch WC.
Damper Travel Time	[60] seconds	<b>Cannot be modified from default</b>
Zone Dampers		Detect or Select the zone damper outputs and name the zones.
Auto Detect Installed Dampers	[Disabled]/Enabled	Toggle ON to have the system auto detect the installed dampers. The system will monitor for a load on the damper outputs when enabled. The control will see the load on each damper output and automatically configure the number of zones according to the dampers detected.
Renumber Zone Panels	[Disabled]/Enabled	May be necessary when there are two zone panels within the system. If the zone numbers are not correctly auto-assigned to two zone panels, initiate the renumbering of the zone panels BEFORE beginning zoning configuration. The zone panel number LEDs on the two zone panels will be swapped as a result.
Automatic Zone Size Mode	Disabled/[Enabled]	Defaults to Automatic Zone Size Mode. Toggle OFF to configure and operate the system in Manual Zone Size Mode. In Automatic Zone Size Mode, the duct learning routine will evaluate static pressure over time, via updates to the model, to correlate damper position to zone requested capacity.
Run Auto Zone Sizing	[Off]/On	Toggle ON to run auto zone sizing. Minutes To complete will count down during auto zone sizing.

Automatic Zone Size Mode:		
Total Auto Zone Size		Sum of the zones' Last Auto Zone Sizes. Displayed at the current Target Static Pressure setting. Must be > 100% when in Automatic Zone Size Mode.
Total Learned Zone Size		Sum of the zones' Learned Zone Sizes which have been learned over time. Displayed at the current Target Static Pressure setting.
Total System Size		Sum of the Zones' Sizes.
Last Auto Zone Size (zones 1-6)		Auto zone sizes per zone at the current Target Static Pressure setting.
Learned Zone Size (zones 1-6)		Learned zone sizes per zone at the current Target Static Pressure setting.
Air Noise - Capacity Reduction		Customizable slider for addressing noise issues on a per zone basis. Can be set from 50% to 100% of Nominal Indoor Airflow.
Zone Size (zones 1-6)		The maximum airflow for each zone. The Zone Sizes are the result of the Auto Zone Sizes being multiplied by the Air Noise - Capacity Reduction slider values.

## Installation Guide

<b>Manual Zone Size Mode:</b>		
Total Auto Zone Size		Sum of the zones' Last Auto Zone Sizes. Displayed at 0.9" WC.
Total Available Zone Size		Sum of the zones' Available Zone Sizes. Displayed at the current Target Static Pressure setting.
Total System Size		Sum of the Manual zone sizes.
Last Auto Zone Size (zones 1-6)		Auto Zone Sizes per zone at the current Target Static Pressure setting. For reference when setting the Manual Zone Sizes.
Available Zone Size (zones 1-6)		The auto zone sizes per zone recalculated at the current Target Static Pressure setting. For reference when setting the Manual Zone Sizes.
Manual Zone Size (zones 1-6)		Slider for setting the Manual Zone Sizes of the zones. can be set from 5% to 100% of Nominal Indoor Airflow.

<b>Brand Modes:</b>		
Zone Name	[Zone 1-6]	Zone names are defaulted to Zone 1 to Zone 6. Zone name can be selected from a list or set to a custom name.
Zone Priority	Low/(Med]/High	Customizable setting to specify each zone's relative priority within the calculations for control of the zones' capacity and comfort. The Zone Priorities cannot all be set to Low at the same time.

## 13. Zone Panel Replacement

In the event a zone panel needs to be replaced, then remove the wires from the failed zone panel and remove the panel.

Set the new panel and land the wires for the zone dampers and wired sensors; then plug the Link communicating connectors on the new panel.

Link will recognize a new panel online and will automatically replace the old panel that is offline.

The zone names, priorities, sizes, and sensors are automatically reassigned to their appropriate zones.

Navigate to the system summary page and remove the offline zone panel.

The offline zone panel will remain in the summary table until it is removed by a technician.

Navigate to the zone configuration menus to ensure all zones are configured correctly.

It's a best practice to enter the zone air flow test to ensure the zone dampers are working properly.

When replacing two zone panels at the same time (possibly from a lightning storm), evaluate proper zone panel numbering when reapplying power to the system.

**NOTE:** *Renumber panels if needed.*

**NOTE:** *Zoning can be impacted due to a Partial Restore vs a Full Restore to factory defaults.*

**Partial Restore:** HVAC configuration will be set to factory default values. Zoning configuration, indoor sensor assignments, and user settings will be retained.

**Full Restore:** Erases all user and installer settings and restores the system to factory default configuration.

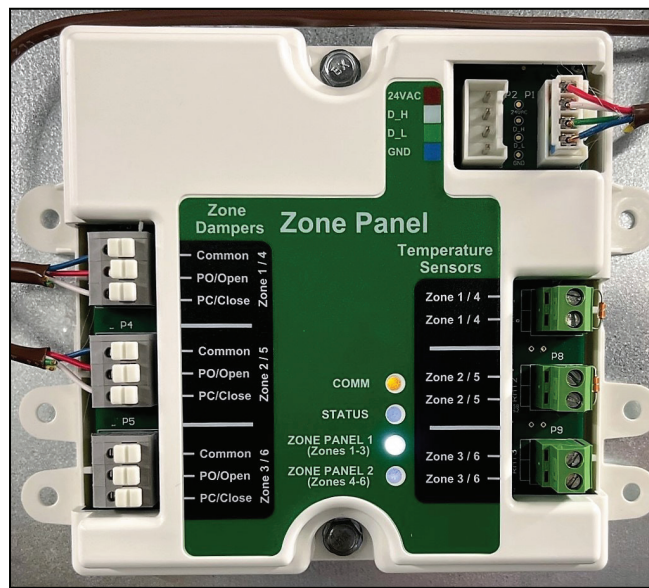

## About Trane and American Standard Heating and Air Conditioning

Trane and American Standard create comfortable, energy efficient indoor environments for residential applications. For more information, please visit [www.trane.com](http://www.trane.com) or [www.americanstandardair.com](http://www.americanstandardair.com)

---

The manufacturer has a policy of continuous data improvement and it reserves the right to change design and specifications without notice. We are committed to using environmentally conscious print practices.

*Representative-only illustrations included in this document.*

*All trademarks referenced are the trademarks of their respective owners. Google is a trademark of Google LLC.*

18-HD99D1-1A-EN 11 Aug 2023  
Supersedes (New)

© 2023