

INSTALLER'S GUIDE

18-GJ58D1-5A-EN

ALL phases of this installation must comply with NATIONAL, STATE AND LOCAL CODES

Cabinet Separation Guide for Special Applications

For Hyperion™
and ForeFront™
Air Handlers

IMPORTANT – This Document is customer property and is to remain with this unit. Please return to service information pack upon completion of work.

Section 1. Safety Information

WARNING

SAFETY HAZARD! This information is intended for use by individuals possessing adequate backgrounds of electrical and mechanical experience. Any attempt to repair a central air conditioning product may result in personal injury and/or property damage. The manufacturer or seller cannot be responsible for the interpretation of this information, nor can it assume any liability in connection with its use.

WARNING

SAFETY HAZARD! Sharp Edge Hazard. Be careful of sharp edges on equipment or any cuts made on sheet metal while installing or servicing. Personal injury may result.

IMPORTANT - Set the air handler in an open environment that provides plenty of room to perform the procedure.

NOTE - It is recommended that the sheet metal pieces be prepared prior to getting to the job site.

General Information

These instructions are to be used as a guide to separate the cabinets into halves when access to the installation point is restricted due to physical size.

WARNING

LIVE ELECTRICAL COMPONENTS! During installation, testing, servicing, and troubleshooting of this product, it may be necessary to work with live electrical components. Failure to follow all electrical safety precautions when exposed to live electrical components could result in death or serious injury.

CAUTION

SAFETY HAZARD!
Cutting of air handler cabinet materials for the cabinet separation procedure for Hyperion™ and ForeFront™ air handlers may result in debris being released into the air. PPE (Personal Protection Equipment) equipment for protection of the eyes, mouth, and nose is recommended during the cabinet separation procedure.

NOTE - Debur the metal spline plates or foil tape the spline plates to avoid sharp edges.

Material Required

Materials required:

- Material: 24 GA (minimum) sheet metal, 4" wide x 61" long (sheet metal will be cut to length, model dependent)
- For best results, 2 rows of clearance holes spaced 4" apart should be pre-drilled based on dimensioned bracket drawings.
- Circular saw
- Sheet metal screws (0.5" long)
- Silicone based caulk

Installer's Guide

Field Supplied Bracket Dimensions

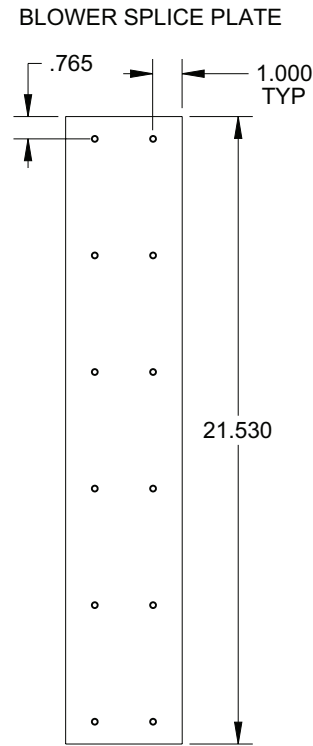
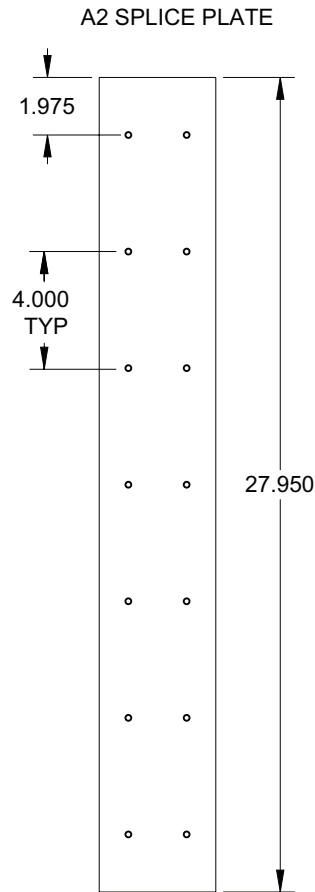

Material : 24 GA (minimum) sheet metal, 4" wide
Debur to avoid sharp edges

A2 Splice Plate used with models:
TAM9A0A24
TAM8C0A24
TAM7A0A24
TAM4A0A18
TAM4A0A24
TAM4A0A30
TAM4A0A36
GAM5B0A18
GAM5B0A24
TAMGB0A24

Blower Splice Plate used with all models
--

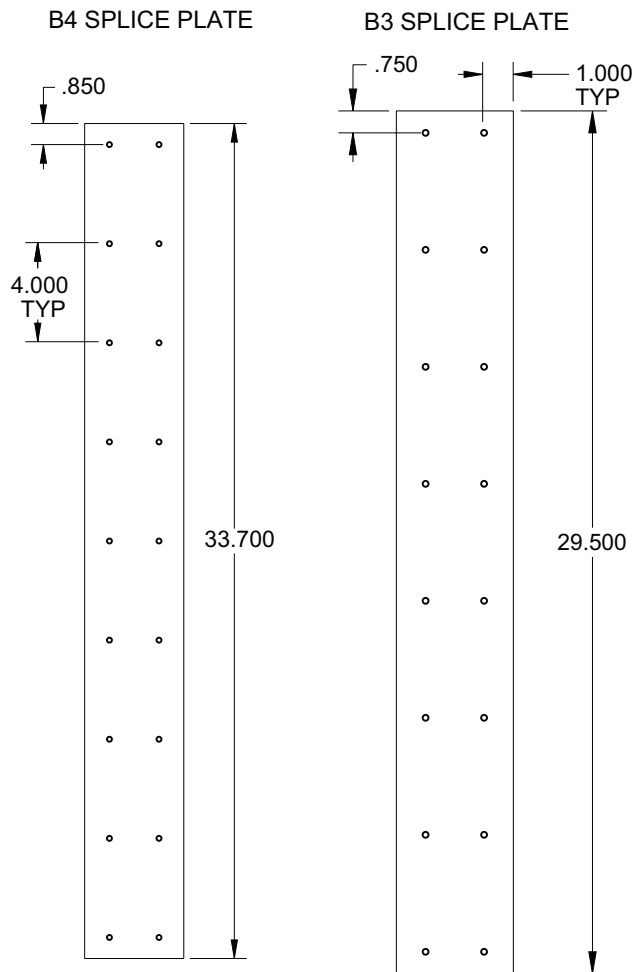

Material : 24 GA (minimum) sheet metal, 4" wide
Debur to avoid sharp edges

B4 Splice Plate used with models:
TAM9A0B30
TAM8C0B30
TAM7A0B30
TAM4A0B42
GAM5B0B36

B3 Splice Plate used with models:
GAM5B0B30

Installer's Guide

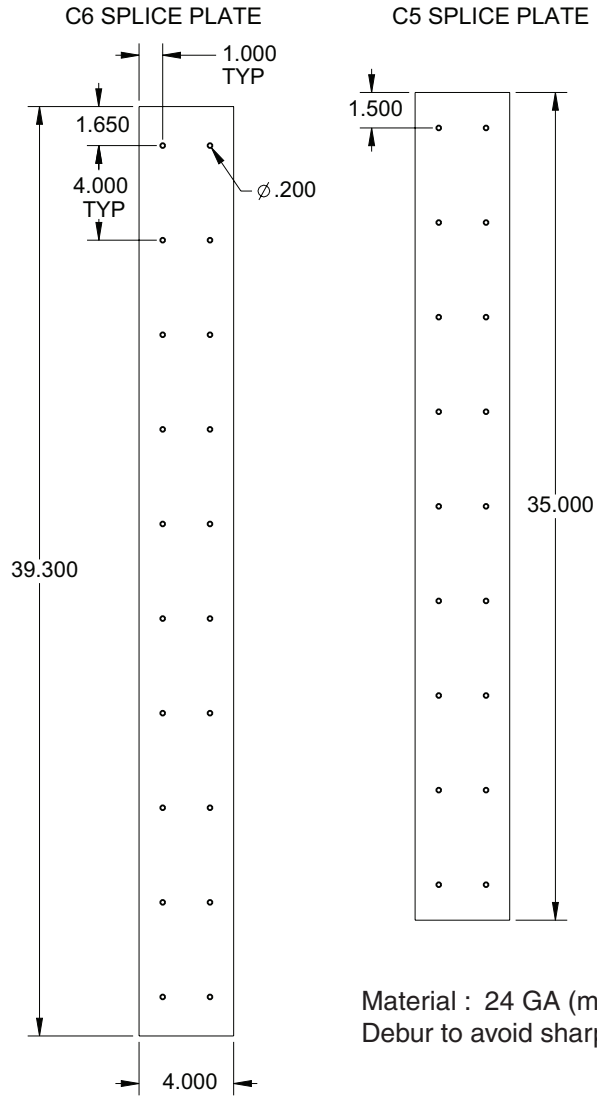

Material : 24 GA (minimum) sheet metal, 4" wide
Debur to avoid sharp edges

C5 Splice Plate used with models:
TAM9A0C36
TAM9A0C42
TAM8A0C36
TAM8C0C42
TAM7A0C36
TAM7A0C42
TAM4A0C48
GAM5B0C42
TAMGB0C36

C6 Splice Plate used with models:
TAM9A0C48
TAM9A0C60
TAM8C0C48
TAM8C0C60
TAM7A0C48
TAM7A0C60
TAM4A0C60
GAM5B0C48
GAM5B0C60
TAMGB0C48
TAMGB0C60

Installation Instructions

1. Remove coil and blower cabinets per the Installer's Guide of the air handler.
2. Separate coil and blower cabinets per the Installer's Guide of the air handler.
3. Remove top plate and bottom rail on coil cabinet per the Installer's Guide of the air handler.
4. Remove upper and lower rails on blower cabinet per the Installer's Guide of the air handler.
5. Lay the cabinet so that the back is facing up.
6. Mark the back of the cabinet per the dimensions below as a guide for cutting.
 - a) 23.5" cabinets = Mark at 11.75"
 - b) 21.5" cabinets = Mark at 10.75"
 - c) 17.5" cabinets = Mark at 8.75"

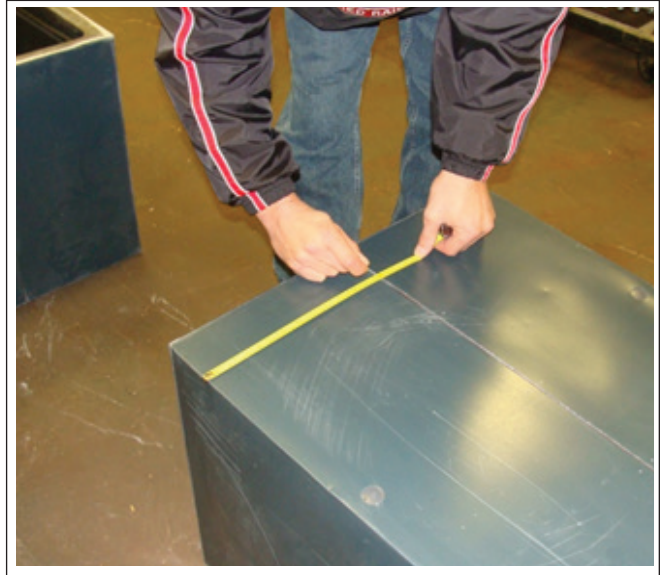

Figure 1

IMPORTANT – Set skill saw at 0.5" maximum cutting depth (do not cut the inner cabinet)

7. Cut along the marked line (a straight edge may be useful).
 - a) The edges(ends) may need to be cut with tin snips.
 - b) Deburr as necessary.
8. Separate the cabinet by setting cabinet upright and squeezing the cabinet together.
 - a) Deburr as necessary.



Figure 2

Installer's Guide

Reassembly

IMPORTANT – Reinstall the top plate and all crossmembers before installing the spline plates. The coil and blower sections are assembled in the same manner.

9. Line up cabinet halves and reinstall the top plate and all crossmembers on the cabinet.
10. Lay the cabinet so that the back is facing up.
11. Apply silicone based caulk down the cut seam.

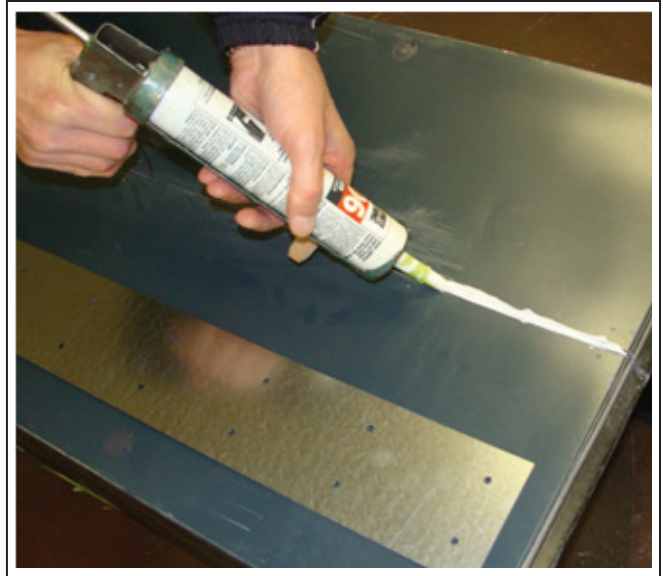

Figure 3

12. Apply additional caulk on the pre-cut sheet metal .



Figure 4

Installer's Guide

- Center the sheet metal over the cut seam and apply screws.

NOTE – DO NOT use a cordless driver that is set to the "drill" setting. Use a low-range torque setting for optimal results (13 in-lb).

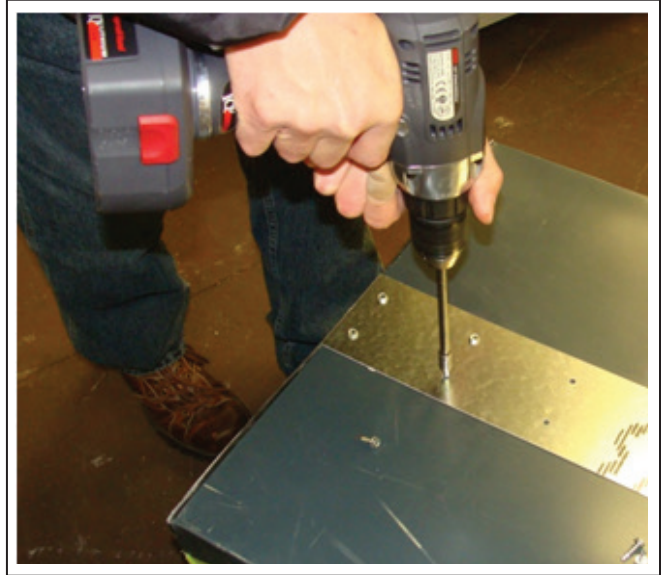

Figure 5

- Repeat steps for other cabinet.
 - No other material for sealing is required on the inner cabinet.

NOTE – Foil tape the spline plates if sharp edges are present.

- Reassemble cabinet in the reverse order above, referencing the air handler Installer Guide.

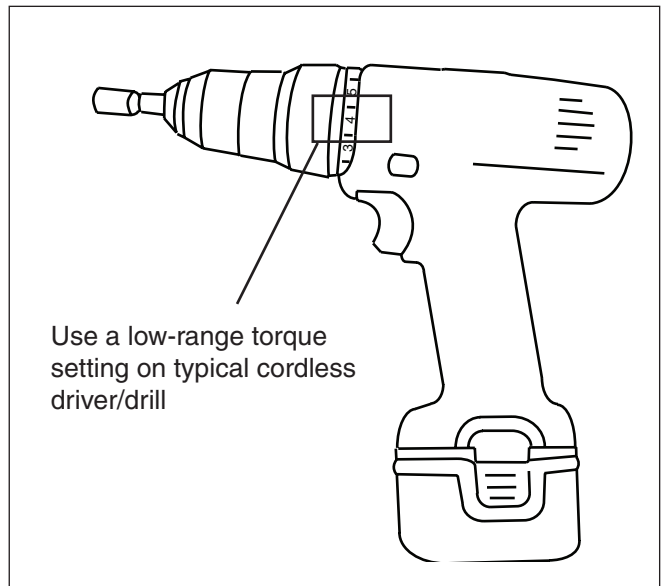

Figure 6

About Trane and American Standard Heating and Air Conditioning
Trane and American Standard create comfortable, energy efficient indoor environments for residential applications.
For more information, please visit www.trane.com or www.americanstandardair.com



The manufacturer has a policy of continuous data improvement and it reserves the right to change design and specifications without notice. We are committed to using environmentally conscious print practices.

18-GJ58D1-5A-EN 08 April 2020
Supersedes 18-GJ58D1-5 (Mar 2017)

© 2020