



Installation and Operation Manual

Heat Pumps 4TWR4

ALL phases of this installation must comply with NATIONAL, STATE AND LOCAL CODES

IMPORTANT – This Document is customer property and is to remain with this unit. Please return to service information pack upon completion of work.

These instructions do not cover all variations in systems or provide for every possible contingency to be met in connection with the installation. Should further information be desired or should particular problems arise which are not covered sufficiently for the purchaser's purposes, the matter should be referred to your installing dealer or local distributor.

Note: The manufacturer recommends installing only approved matched indoor and outdoor systems. All of the manufacture's split systems are AHRI rated only with TXV/EEV indoor systems. Some of the benefits of installing approved matched indoor and outdoor split systems are maximum efficiency, optimum performance and the best overall system reliability.

Table of Contents

- Section 1. Safety 2
- Section 2. Unit Location Considerations 4
- Section 3. Unit Preparation 5
- Section 4. Setting the Unit 5
- Section 5. Refrigerant Line Considerations 5
- Section 6. Refrigerant Line Routing 6
- Section 7. Refrigerant Line Brazing 8
- Section 8. Refrigerant Line Leak Check 8
- Section 9. Evacuation 9
- Section 10. Service Valves 9
- Section 11. Electrical – Low Voltage 10
- Section 12. Electrical – High Voltage 11
- Section 13. Start Up 12
- Section 14. System Charge Adjustment 12
- Section 15. Checkout Procedures 16
- Section 16. Defrost Control 17
- Section 17. Troubleshooting 20
- Section 18. Wiring Diagrams 22
- Section 19. Pressure Curves 25
- Section 20. Refrigerant Circuit 30

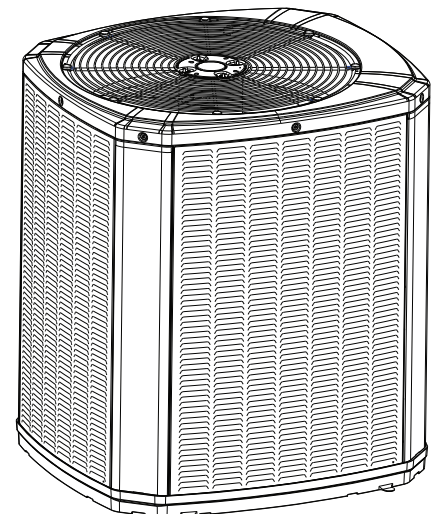

Section 1. Safety

WARNING

This information is intended for use by individuals possessing adequate backgrounds of electrical and mechanical experience. Any attempt to repair a central air conditioning product may result in personal injury and/or property damage. The manufacture or seller cannot be responsible for the interpretation of this information, nor can it assume any liability in connection with its use.

WARNING

These units use R-410A refrigerant which operates at 50 to 70% higher pressures than R-22. Use only R-410A approved service equipment. Refrigerant cylinders are painted a “Rose” color to indicate the type of refrigerant and may contain a “dip” tube to allow for charging of liquid refrigerant into the system. All R-410A systems use a POE oil that readily absorbs moisture from the atmosphere. To limit this “hygroscopic” action, the system should remain sealed whenever possible. If a system has been open to the atmosphere for more than 4 hours, the compressor oil must be replaced. Never break a vacuum with air and always change the driers when opening the system for component replacement. For specific handling concerns with R-410A and POE oil reference Retrofit Bulletins SS-APG006-EN and APP-APG011-EN or APP-APG012-EN.

WARNING

UNIT CONTAINS R-410A REFRIGERANT!
R-410A operating pressures exceed the limit of R-22. Proper service equipment is required. Failure to use proper service tools may result in equipment damage or personal injury.

SERVICE

USE ONLY R-410A REFRIGERANT AND APPROVED POE COMPRESSOR OIL.

WARNING

Extreme caution should be exercised when opening the Liquid Line Service Valve. Turn counterclockwise until the valve stem just touches the rolled edge. No torque is required. Failure to follow this warning will result in abrupt release of system charge and may result in personal injury and /or property damage.

WARNING

LIVE ELECTRICAL COMPONENTS!
During installation, testing, servicing, and troubleshooting of this product, it may be necessary to work with live electrical components. Failure to follow all electrical safety precautions when exposed to live electrical components could result in death or serious injury.

CAUTION

If using existing refrigerant lines make certain that all joints are brazed, not soldered.

CAUTION

Scroll compressor dome temperatures may be hot. Do not touch the top of compressor; it may cause minor to severe burning.

WARNING

HAZARDOUS VOLTAGE!

Failure to follow this Warning could result in property damage, severe personal injury, or death. Disconnect all electric power, including remote disconnects before servicing. Follow proper lockout/tagout procedures to ensure the power cannot be inadvertently energized.

WARNING

REFRIGERANT OIL!

Failure to follow this Warning could result in property damage, severe personal injury, or death. These units use R-410A refrigerant which operates at 50–70% higher pressures than R-22. Use only R-410A approved service equipment. Refrigerant cylinders are painted a “Rose” color to indicate the type of refrigerant and may contain a “dip” tube to allow for charging of liquid refrigerant into the system. All R-410A systems use a POE oil that readily absorbs moisture from the atmosphere. To limit this “hygroscopic” action, the system should remain sealed whenever possible. If a system has been open to the atmosphere for more than 4 hours, the compressor oil must be replaced. Never break a vacuum with air and always change the driers when opening the system for component replacement. For specific handling concerns with R-410A and POE oil, reference Retrofit Bulletin TRN-APG02-EN.

CAUTION

HOT SURFACE!

May cause minor to severe burning. Failure to follow this Caution could result in property damage or personal injury. Do not touch top of compressor.

⚠ CAUTION

CONTAINS REFRIGERANT!

Failure to follow proper procedures can result in personal illness or injury or severe equipment damage.

System contains oil and refrigerant under high pressure. Recover refrigerant to relieve pressure before opening system.

⚠ CAUTION

GROUNDING REQUIRED!

Failure to inspect or use proper service tools may result in equipment damage or personal injury. Reconnect all grounding devices. All parts of this product that are capable of conducting electrical current are grounded. If grounding wires, screws, straps, clips, nuts, or washers used to complete a path to ground are removed for service, they must be returned to their original position and properly fastened.

⚠ WARNING

SERVICE VALVES!

Failure to follow this warning will result in abrupt release of system charge and may result in personal injury and/or property damage. Extreme caution should be exercised when opening the Suction and Liquid Line Service Valve. Turn valve stem counterclockwise only until the stem contacts the rolled edge. No torque is required.

⚠ WARNING

BRAZING REQUIRED - IF USING MECHANICAL CONNECTIONS, ENSURE LEAK TEST IS NEGATIVE!

Failure to inspect lines or use proper service tools may result in equipment damage or personal injury. If using existing refrigerant lines make certain that all joints are brazed, not soldered.

⚠ WARNING

Warning!

This product can expose you to chemicals including lead which are known to the State of California to cause cancer and birth defects or other reproductive harm.

For more information go to www.P65Warnings.ca.gov

Important: If using other than copper pipe, follow manufacturer's installation instructions. Joints must be brazed or other UL/IMC/URMC approved joint that meets pressure requirements.

Section 2. Unit Location Considerations

2.1 Unit Dimensions and Weight

Table 2.1

Unit Dimensions and Weight		
Models	H x D x W (in)	Weight* (lb)
4TWR4017N	29 x 26 x 29	141
4TWR4018N	33 x 30 x 33	174
4TWR4024N	33 x 30 x 33	174
4TWR4030N	29 x 30 x 33	163
4TWR4036N	37 x 34 x 37	199
4TWR4042N	45 x 34 x 37	227
4TWR4048N	45 x 34 x 37	250
4TWR4060N	45 x 34 x 37	251

* Weight values are estimated uncrated.

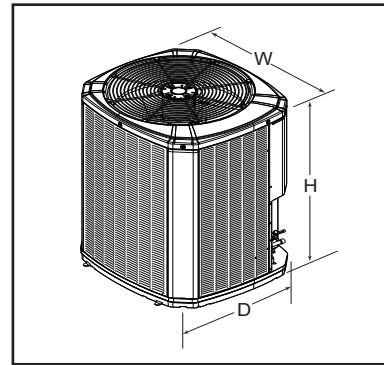

When mounting the outdoor unit on a roof, be sure the roof will support the unit's weight.

Properly selected isolation is recommended to alleviate sound or vibration transmission to the building structure.

2.2 Refrigerant Piping Limits

1. The maximum TOTAL length of refrigerant lines from outdoor to indoor unit should NOT exceed 150 feet (including lift).
2. The maximum vertical change should not exceed 50 feet.
3. Service valve connection diameters are shown in Table 5.1.

Note: For other line lengths, Refer to Refrigerant Piping Application Guide, SS-APG006F-EN, or Refrigerant Piping Software Program.

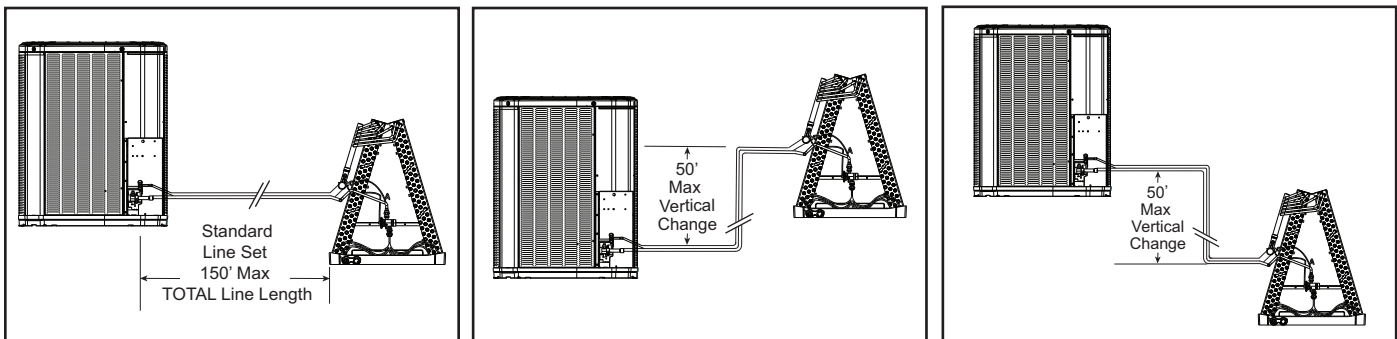

2.3 Suggested Locations for Best Reliability

Ensure the top discharge area is unrestricted for at least five (5) feet above the unit.

Three (3) feet clearance must be provided in front of the control box (access panels) and any other side requiring service.

It is not recommended to install in a location where noise may distract the building occupants. Some examples of these types of locations are sleeping quarters and by windows of a living area. Please discuss location with the building owner prior to installation.

Avoid locations such as near windows where condensation and freezing defrost vapor can annoy a customer. Position the outdoor unit a minimum of 12" from any wall or surrounding shrubbery to ensure adequate airflow. Outdoor unit location must be far enough away from any structure to prevent excess roof runoff water or icicles from falling directly on the unit.

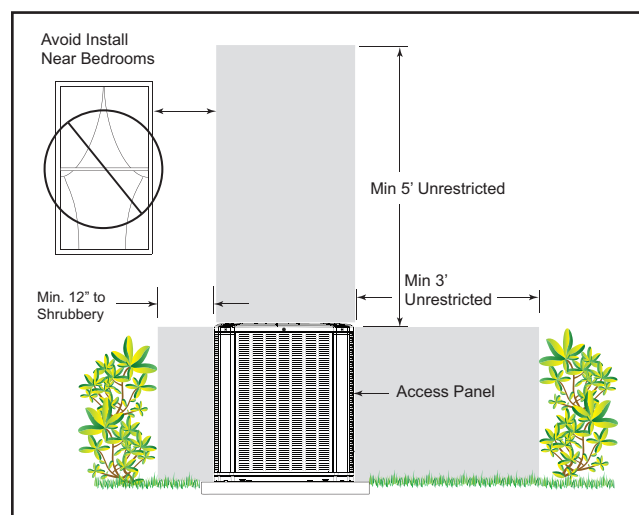

2.4 Cold Climate Considerations

NOTE: It is recommended that these precautions be taken for units being installed in areas where snow accumulation and prolonged below freezing temperatures occur.

- Units should be elevated 3-12 inches above the pad or rooftop, depending on local weather. This additional height will allow drainage of snow and ice melted during defrost cycle prior to its refreezing. Ensure that drain holes in unit base pan are not obstructed preventing draining of defrost water.
- If possible, avoid locations that are likely to accumulate snow drifts. If not possible, a snow drift barrier should be installed around the unit to prevent a build-up of snow on the sides of the unit.

2.5 Coastal Considerations

If installed within one mile of salt water, including seacoasts and inland waterways, models without factory supplied Seacoast Salt Shields require the addition of BAYSEAC001 (Seacoast Kit) at installation time.

Section 3. Unit Preparation

3.1 Prepare The Unit For Installation

STEP 1 - Check for damage and report promptly to the carrier any damage found to the unit.

STEP 2 - To remove the unit from the pallet, remove tabs by cutting with a sharp tool.

Section 4. Setting the Unit

4.1 Pad Installation

When installing the unit on a support pad, such as a concrete slab, consider the following:

- The pad should be at least 1" larger than the unit on all sides.
- The pad must be separate from any structure.
- The pad must be level.
- The pad should be high enough above grade to allow for drainage.
- The pad location must comply with National, State, and Local codes.

Section 5. Refrigerant Line Considerations

5.1 Refrigerant Line and Service Valve Connection Sizes

Table 5.1

Model	Line Sizes		Service Valve Connection Sizes	
	Vapor Line	Liquid Line	Vapor Line Connection	Liquid Line Connection
4TWR4017N	3/4	3/8	3/4	3/8
4TWR4018N	3/4	3/8	3/4	3/8
4TWR4024N	3/4	3/8	3/4	3/8
4TWR4030N	3/4	3/8	3/4	3/8
4TWR4036N	7/8	3/8	3/4	3/8
4TWR4042N	7/8	3/8	7/8	3/8
4TWR4048N	7/8	3/8	7/8	3/8
4TWR4060N	1-1/8	3/8	7/8	3/8

5.2 Factory Charge

The outdoor condensing units are factory charged with the system charge required for the outdoor condensing unit, ten (10) feet of tested connecting line, and the smallest rated indoor evaporative coil match. Always verify proper system charge via subcooling (TXV/EEV) or superheat (fixed orifice) per the unit nameplate.

5.3 Required Refrigerant Line Length

Determine required line length and lift. You will need this later in STEP 2 of Section 14.

Total Line Length = _____ Ft.

Total Vertical Change (lift) = _____ Ft.

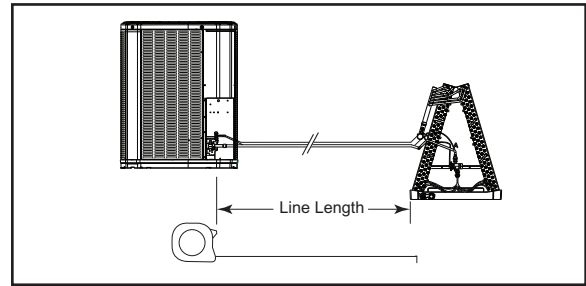

5.4 Refrigerant Line Insulation

Important: The Vapor Line must always be insulated. DO NOT allow the Liquid Line and Vapor Line to come in direct (metal to metal) contact.

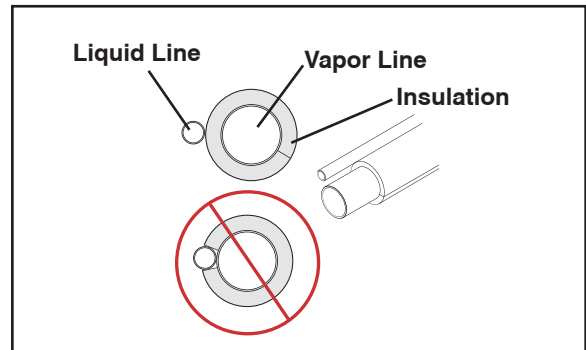

5.5 Reuse Existing Refrigerant Lines

⚠ CAUTION

If using existing refrigerant lines make certain that all joints are brazed, not soldered.

For retrofit applications, where the existing indoor evaporator coil and/or refrigerant lines will be used, the following precautions should be taken:

- Ensure that the indoor evaporator coil and refrigerant lines are the correct size.
- Ensure that the refrigerant lines are free of leaks, acid, and oil.

Section 6. Refrigerant Line Routing

6.1 Precautions

Important: Take precautions to prevent noise within the building structure due to vibration transmission from the refrigerant lines.

Comply with National, State, and Local Codes when isolating line sets from joists, rafters, walls, or other structural elements.

For Example:

- When the refrigerant lines have to be fastened to floor joists or other framing in a structure, use isolation type hangers.
- Isolation hangers should also be used when refrigerant lines are run in stud spaces or enclosed ceilings.
- Where the refrigerant lines run through a wall or sill, they should be insulated and isolated.
- Isolate the lines from all ductwork.
- Minimize the number of 90° turns.

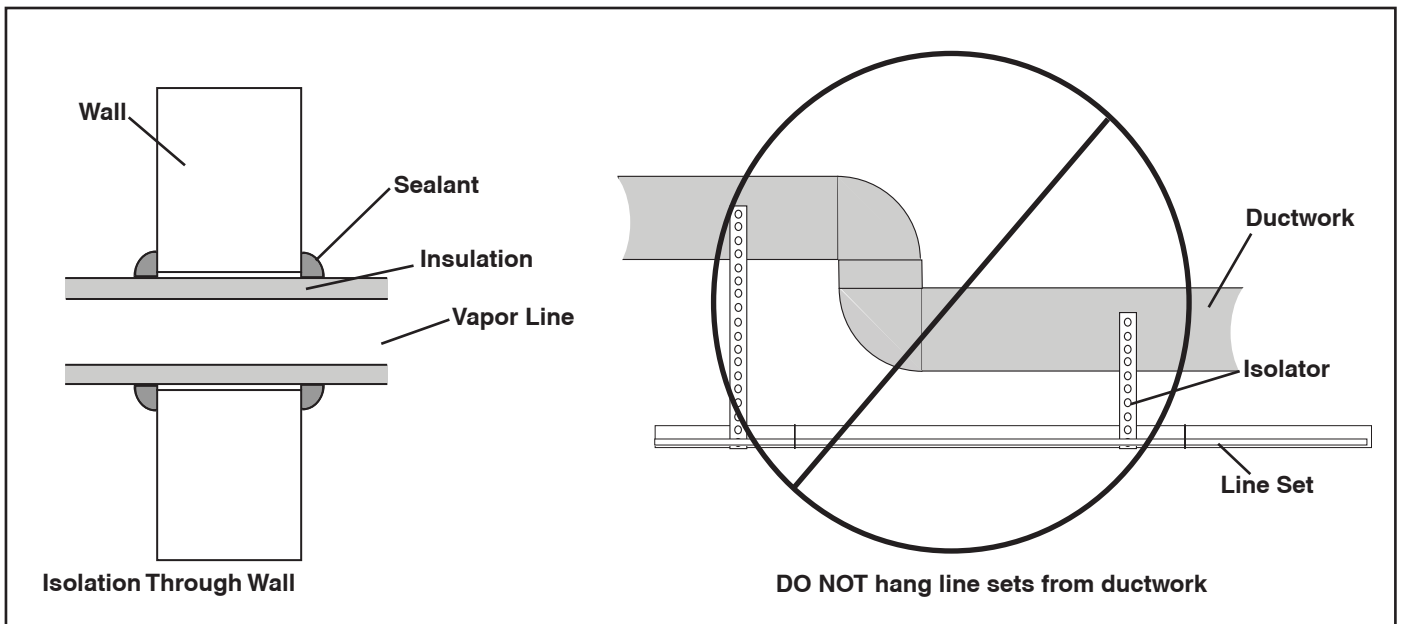
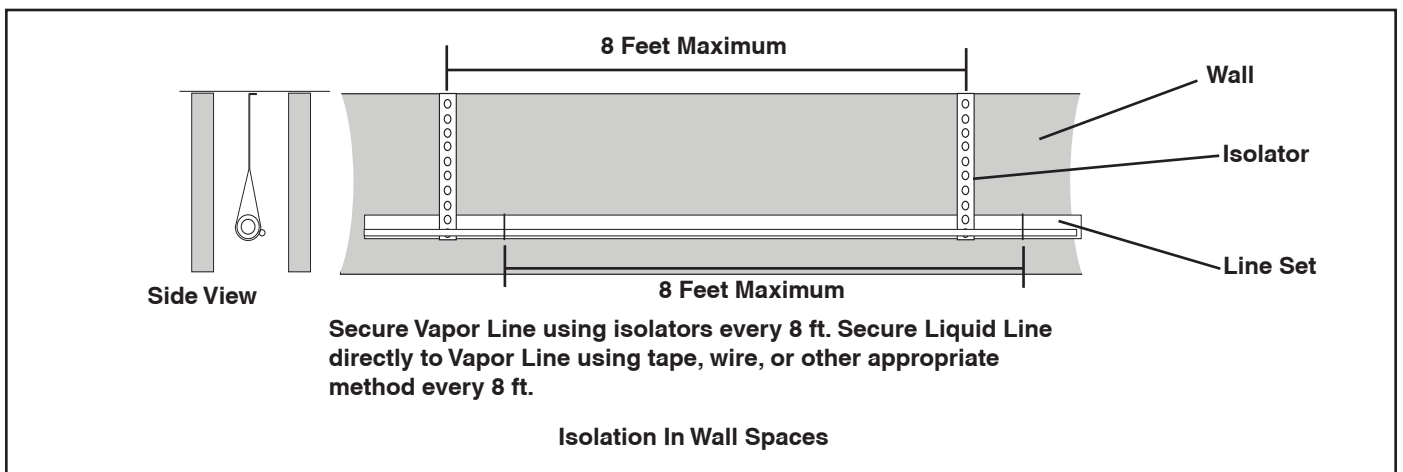
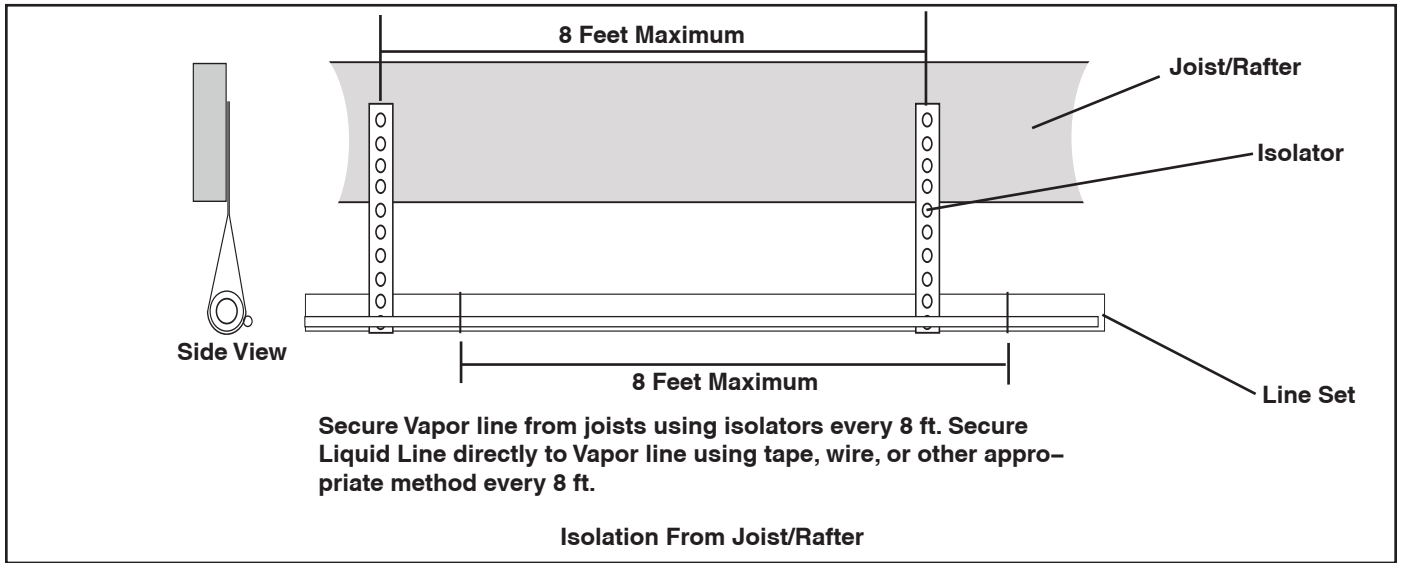

Section 7. Refrigerant Line Brazing

7.1 Braze The Refrigerant Lines

STEP 1 - Remove caps or plugs. Use a deburring tool to deburr the pipe ends. Clean both internal and external surfaces of the tubing using an emery cloth.

STEP 2 - Remove the pressure tap cap and valve cores from both service valves.

STEP 3 - Purge the refrigerant lines and indoor coil with dry nitrogen.

STEP 4 - Wrap a wet rag around the valve body to avoid heat damage and continue the dry nitrogen purge. Braze the refrigerant lines to the service valves.

For units shipped with a field-installed external drier, check liquid line filter drier's directional flow arrow to confirm correct direction of refrigeration flow (away from outdoor unit and toward evaporator coil) as illustrated. Braze the filter drier to the Liquid Line.

Continue the dry nitrogen purge. Do not remove the wet rag until all brazing is completed.

Important: Remove the wet rag before stopping the dry nitrogen purge.

Note: Install drier in Liquid Line.

NOTE: Precautions should be taken to avoid heat damage to basepan during brazing. It is recommended to keep the flame directly off of the basepan.

STEP 5 - Replace the pressure tap valve cores after the service valves have cooled.

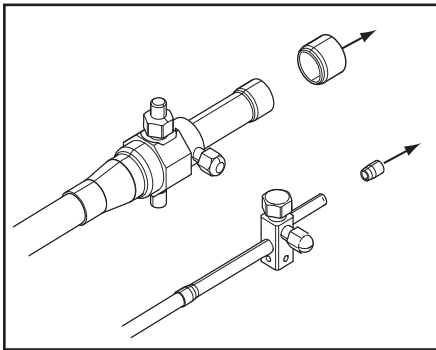

STEP 1

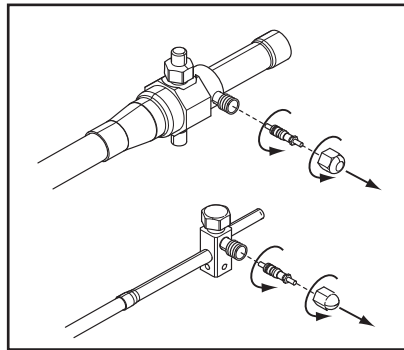

STEP 2

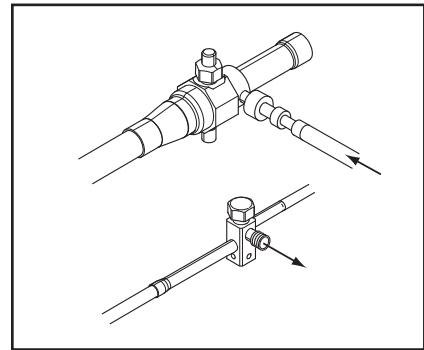

STEP 3

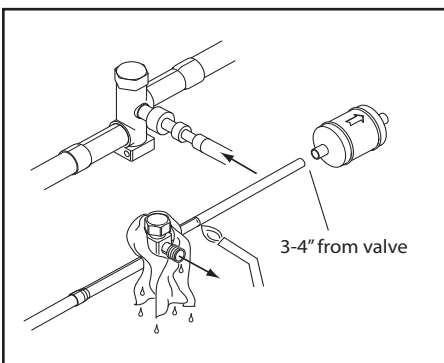

STEP 4

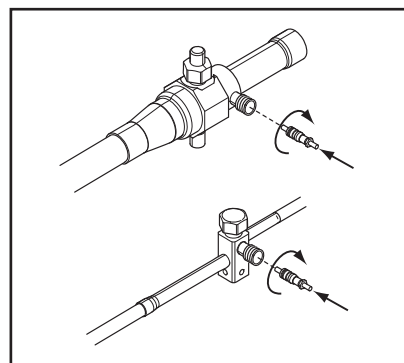

STEP 5

Section 8. Refrigerant Line Leak Check

8.1 Check For Leaks

STEP 1 - Pressurize the refrigerant lines and evaporator coil to 150 PSIG using dry nitrogen.

STEP 2 - Check for leaks by using a soapy solution or bubbles at each brazed location. Remove nitrogen pressure and repair any leaks before continuing.

Section 9. Evacuation

9.1 Evacuate the Refrigerant Lines and Indoor Coil

Important: Do not open the service valves until the refrigerant lines and indoor coil leak check and evacuation are complete.

STEP 1 - Evacuate until the micron gauge reads no higher than 350 microns, then close off the valve to the vacuum pump.

STEP 2 - Observe the micron gauge. Evacuation is complete if the micron gauge does not rise above 500 microns in one (1) minute.

Once evacuation is complete blank off the vacuum pump and micron gauge, and close the valves on the manifold gauge set.

Section 10. Service Valves

10.1 Open the Gas Service Valve

Important: Leak check and evacuation must be completed before opening the service valves.

NOTE: Do not vent refrigerant gases into the atmosphere.

STEP 1 - Remove valve stem cap.

STEP 2 - Using an adjustable wrench, turn valve stem 1/4 turn counterclockwise to the fully open position.

STEP 3 - Replace the valve stem cap to prevent leaks. Tighten finger tight plus an additional 1/6 turn.

10.2 Open the Liquid Service Valve

⚠ WARNING

Extreme caution should be exercised when opening the Liquid Line Service Valve. Turn counterclockwise until the valve stem just touches the rolled edge. No torque is required. Failure to follow this warning will result in abrupt release of system charge and may result in personal injury and /or property damage.

Important: Leak check and evacuation must be completed before opening the service valves.

STEP 1 - Remove service valve cap.

STEP 2 - Fully insert 3/16" hex wrench into the stem and back out counterclockwise until valve stem just touches the rolled edge (approximately five (5) turns.)

STEP 3 - Replace the valve cap to prevent leaks. Tighten finger tight plus an additional 1/6 turn.

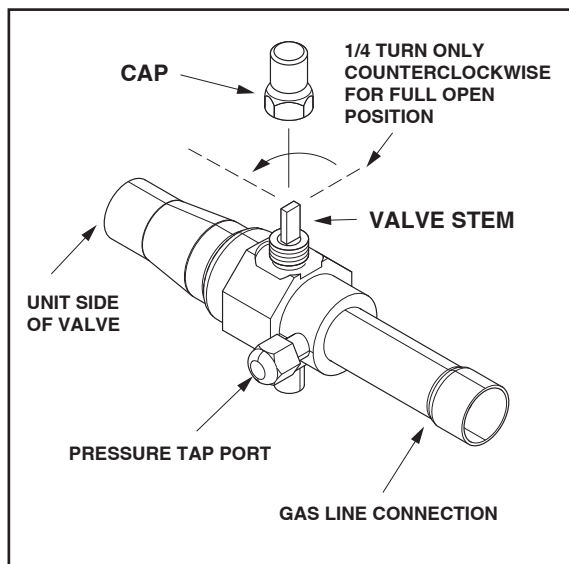

Gas Service Valve

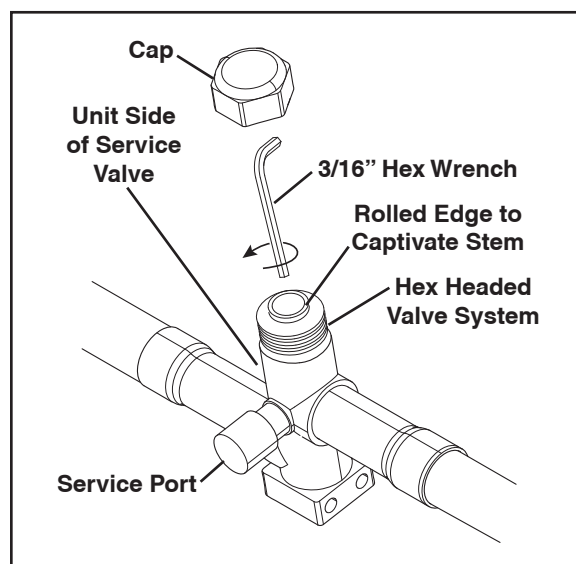

Liquid Service Valve

Section 11. Electrical – Low Voltage

11.1 Low Voltage Maximum Wire Length

Table 11.1 defines the maximum total length of low voltage wiring from the outdoor unit, to the indoor unit, and to the thermostat.

24 VOLTS	
WIRE SIZE	MAX. WIRE LENGTH
18 AWG	150 Ft.
16 AWG	225 Ft.
14 AWG	300 Ft.

11.2 Low Voltage Hook-up Diagrams

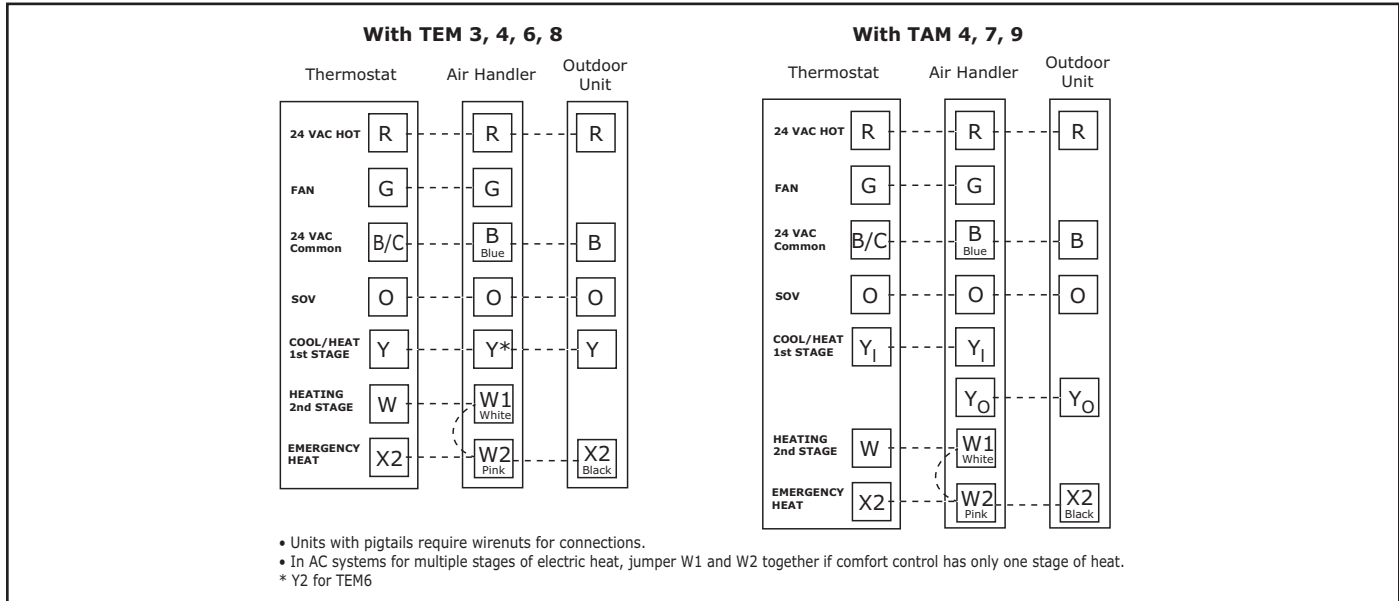

11.3 Defrost Control – All Models except 036

Defrost controls have a selectable termination temperature. As shipped, defrost will terminate at 47°F. For a higher termination temperature, cut **Jumper J2** to achieve 70°F. See Service Facts shipped in the outdoor unit for more information.

Pin Identification on J5 (See Illustration)

1. TEST_COMMON (Shorting to FRC_DFT causes the control to initiate Forced Defrost. Leaving this pin open results in the normal mode of operation.)
2. FRC_DFT = Forced Defrost (Short TEST_COMMON to this pin for two (2) seconds to initiate a forced defrost. Remove the short after defrost initiates.)

Defrost Control Checkout

Normal operation requires:

- Status LED on board flashing 1 time/second in standby or 2 times/second with a call for heating or cooling.
- 24V AC between R & B
- 24V AC between Y, Y0 & B with unit operating
- Defrost initiation when FRC_DFT pin is shorted to TEST_COMMON pin.

If a defrost control problem is suspected, refer to the service information in control box.

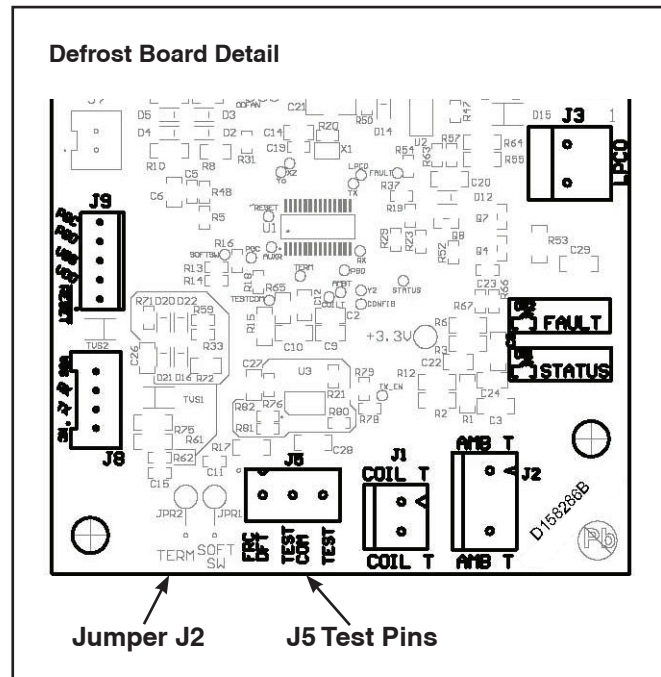

11.3 Defrost Control – 036 Model ONLY

Defrost controls have a selectable termination temperature. As shipped, defrost will terminate at 47°F. For a higher termination temperature, cut Jumper J2 to achieve 70°F when at or below 30°F ambient. See Service Facts shipped in the outdoor unit for more information.

Pin Identification (See Illustration at right)

1. TEST_COMMON (Shorting any of the other pins to this pin causes the function of the other pin to be executed. Leaving this pin open results in the normal mode of operation.)
2. TST = Test (Shorting TEST_COMMON to this pin speeds up all defrost board timings.)
3. FRC_DFT = Forced Defrost (Short TEST_COMMON to this pin for two (2) seconds to initiate a forced defrost. Remove the short after defrost initiates.)

Defrost Control Checkout

Normal operation requires:

- LED on board flashing 1 time/second.
- 24V AC between R & B.
- 24V AC between Y & B with unit operating.
- Defrost initiation when FRC_DFT pin is shorted to TEST_COMMON pin.

If a defrost control problem is suspected, refer to the service information in control box.

Defrost Termination Temperatures		
	Outdoor Temperature	Termination Temperature
As Shipped	>22°F	47°F
	10°F–22°F	ODT + 25°F
	6°F–10°F	35°F
Cut Jumper 2	>30°F	47°F
	6°F–30°F	70°F
All	< 6°F	12 min. or 35°F every 3 hrs.

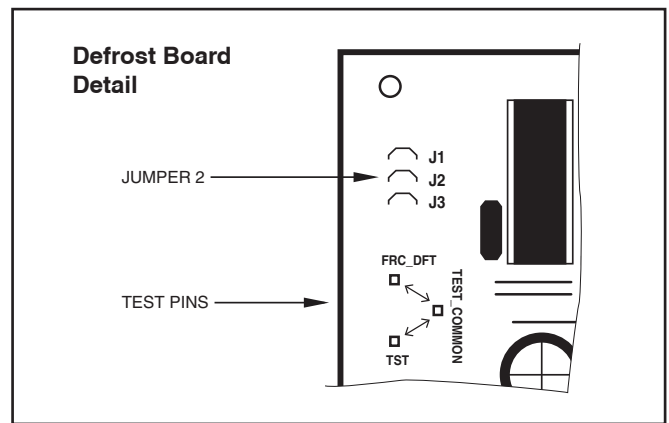

Section 12. Electrical – High Voltage

12.1 High Voltage Power Supply

⚠ WARNING

LIVE ELECTRICAL COMPONENTS!

During installation, testing, servicing, and troubleshooting of this product, it may be necessary to work with live electrical components. Failure to follow all electrical safety precautions when exposed to live electrical components could result in death or serious injury.

The high voltage power supply must agree with the equipment nameplate.

Power wiring must comply with national, state, and local codes.

Follow instructions on unit wiring diagram located on the inside of the control box cover and in the Service Facts document included with the unit.

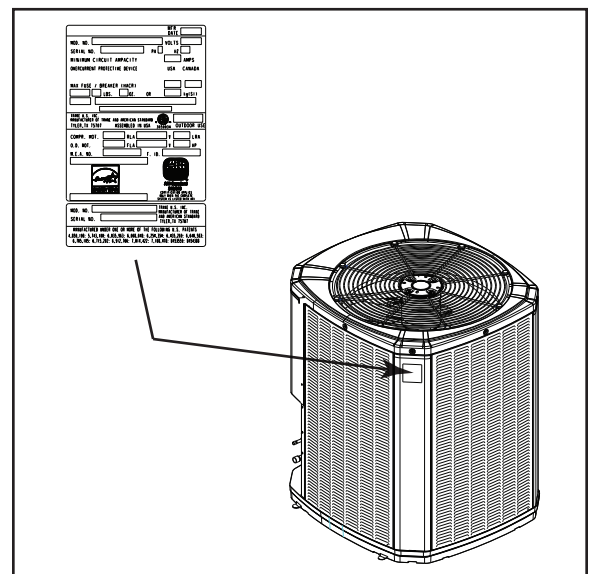

12.2 High Voltage Disconnect Switch

Install a separate disconnect switch at the outdoor unit.

For high voltage connections, flexible electrical conduit is recommended whenever vibration transmission may create a noise problem within the structure.

12.3 High Voltage Ground

Ground the outdoor unit per national, state, and local code requirements.

Section 13. Start Up

13.1 System Start Up

STEP 1 - Ensure Sections 7 through 12 have been completed.

STEP 2 - Set System Thermostat to OFF.

STEP 3 - Turn on disconnect(s) to apply power to the indoor and outdoor units.

STEP 4 - Wait one (1) hour before starting the unit if compressor crankcase heater accessory is used and the Outdoor Ambient is below 70°F.

STEP 5 - Set system thermostat to ON.

Section 14. System Charge Adjustment

14.1 Temperature Measurements

STEP 1 - Check the outdoor temperatures.

Subcooling (in cooling mode) is the only recommended method of charging above 55° F ambient outdoor temperature. See Section 14.2.

For outdoor temperatures below 55° F, see Section 14.3.

Note: It is important to return in the spring or summer to accurately charge the system in the cooling mode when outdoor ambient temperature is above 55° F.

For best results the indoor temperature should be kept between 70° F to 80° F.

See Section 14.2 for
Outdoor
Temperatures
Above 55° F

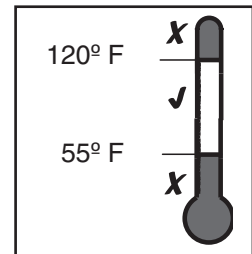

Outdoor Temp 1

See Section 14.3 for
Outdoor
Temperatures
Below 55° F

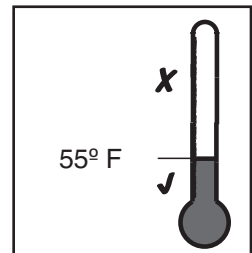

Outdoor Temp 2

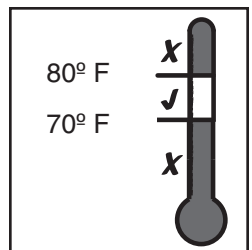

Indoor Temp

14.2 Subcooling Charging in Cooling (Above 55° F Outdoor Temp.)

STEP 1 - Use the refrigerant line total length and lift measurements from Section 5.3.

Total Line Length = _____ Ft.

Vertical Change (Lift) = _____ Ft.

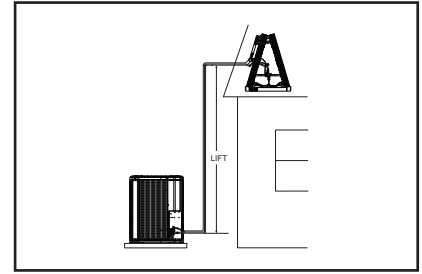

STEP 2 - Determine the final subcooling value using total Line Length and Lift measured in STEP 1 and the charts below.

For 017N – 060N Models:

017N Models

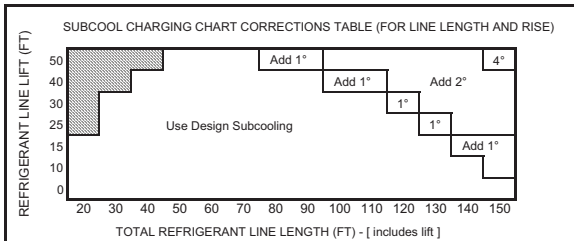

018N Models

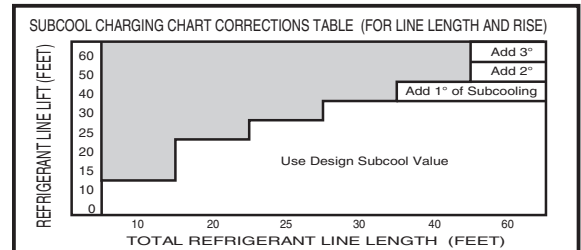

024N Models

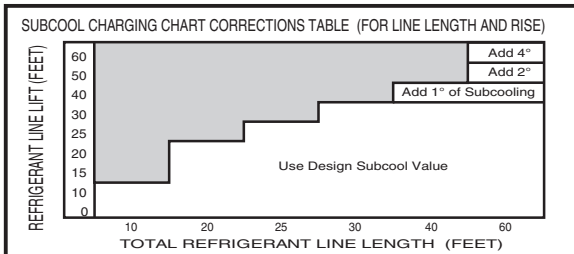

030N Models

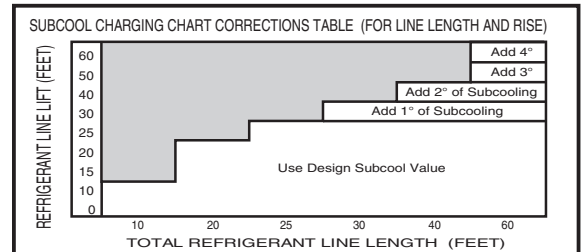

036N Models

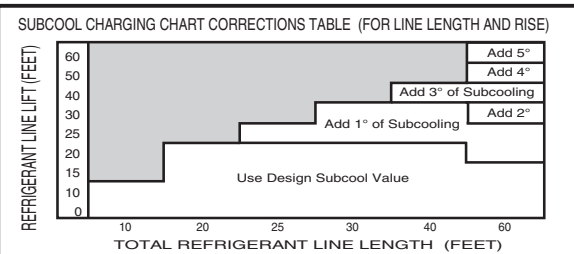

042N Models

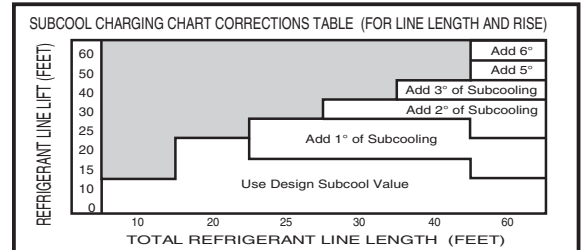

048N Models

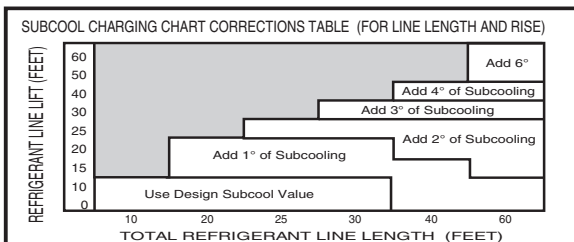

060N Models

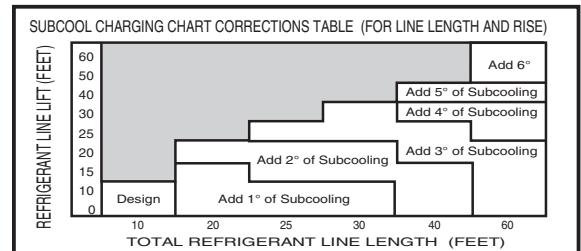

Design Subcooling Value = _____ ° F
(from nameplate or Service Facts)

Subcooling Correction = _____ ° F

Final Subcooling Value = _____ ° F

Special subcooling applications

Outdoor Unit Model No.	Indoor Unit Model No.	Subcooling
4TWR4017N1	GAM5A0B18M11 TAM7A0A24H21	14 Degrees
4TWR4018N1	TEM6A0C36H31	13 Degrees
4A6H4018N1		
4TWX5018N1		
4TWR4024N1	TEM6A0C36H31	13 Degrees
4A6H4024N1		
4TWX5024N1		
4TWR4030N1	TEM6A0B24H21	14 Degrees

STEP 3 - Stabilize the system by operating for a minimum of 20 minutes.

At startup, or whenever charge is removed or added, the system must be operated for a minimum of 20 minutes to stabilize before accurate measurements can be made.

STEP 4 - Measure the liquid line temperature and pressure at the outdoor unit's service valve.

Measured Liquid Line Temp = _____ ° F

Liquid Gage Pressure = _____ PSIG

Final Subcooling Value = _____ ° F

STEP 5 - Use the final subcooling value, refrigerant temperature and pressure from STEP 4, to determine the proper liquid gage pressure using Table 14.2.

Example: Assume a 12° F Final Subcooling value and liquid temp of 90° F.

1. Locate 12° F Final Subcooling in Table 14.2.
2. Locate the Liquid Temperature (90° F) in the left column.
3. The Liquid Gage Pressure should be approximately 327 PSIG. (This is shown as the intersection of the Final Subcooling column and the Liquid Temperature row.)

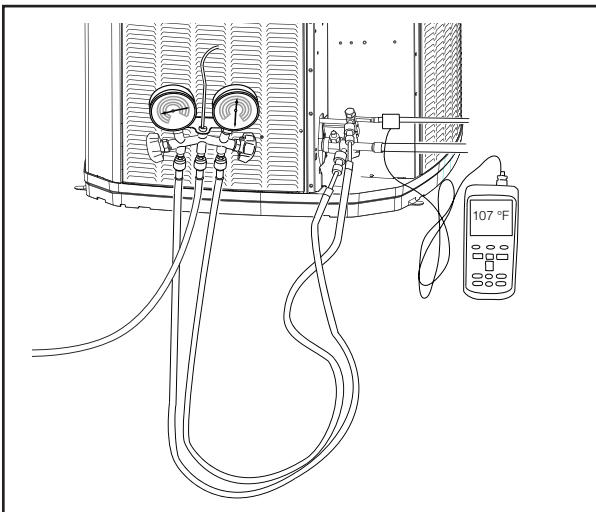

Table 14.2

R-410A REFRIGERANT CHARGING CHART							
LIQUID TEMP (°F)	FINAL SUBCOOLING (°F)						
	8	9	10	11	12	13	14
	LIQUID GAGE PRESSURE (PSI)						
55	179	182	185	188	191	195	198
60	195	198	201	204	208	211	215
65	211	215	218	222	225	229	232
70	229	232	236	240	243	247	251
75	247	251	255	259	263	267	271
80	267	271	275	279	283	287	291
85	287	291	296	300	304	309	313
90	309	313	318	322	327	331	336
95	331	336	341	346	351	355	360
100	355	360	365	370	376	381	386
105	381	386	391	396	402	407	413
110	407	413	418	424	429	435	441
115	435	441	446	452	458	464	470
120	464	470	476	482	488	495	501
125	495	501	507	514	520	527	533

From Dwg. D154557P01 Rev. 3

STEP 6 - Adjust refrigerant level to attain proper gage pressure.

Add refrigerant if the Liquid Gage Pressure is lower than the chart value.

1. Connect gages to refrigerant bottle and unit as illustrated.
2. Purge all hoses.
3. Open bottle.
4. Stop adding refrigerant when liquid line temperature and Liquid Gage Pressure matches the charging chart Final Subcooling value.

Recover refrigerant if the Liquid Gage Pressure is higher than the chart value.

STEP 7 - Stabilize the system.

1. Wait 20 minutes for the system condition to stabilize between adjustments.

Note: When the Liquid Line Temperature and Gage Pressure approximately match the chart, the system is properly charged.

2. Remove gages.
3. Replace service port caps to prevent leaks. Tighten finger tight plus an additional 1/6 turn.

STEP 8 - Verify typical performance.

Refer to System Pressure Curves in the Service Facts to verify typical performance.

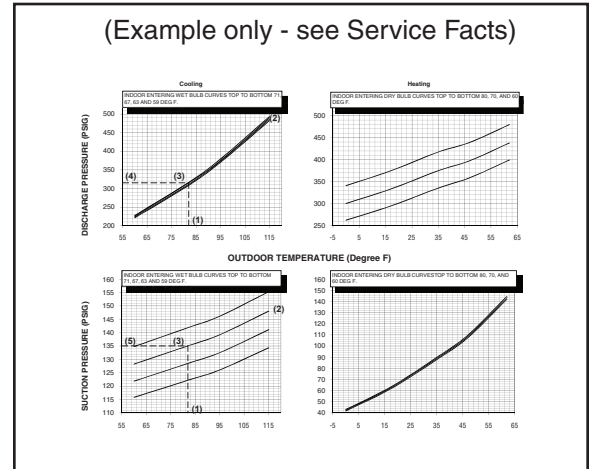
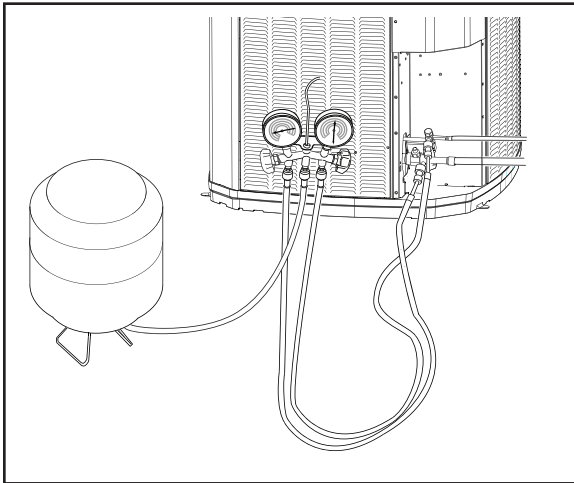

STEP 9 - Record System Information for reference.

Record system pressures and temperatures after charging is complete.

Outdoor model number = _____ Measured Suction Line Temp = _____ ° F

Measured Outdoor Ambient = _____ ° F Liquid Gage Pressure = _____ PSIG

Measured Indoor Ambient = _____ ° F Suction Gage Pressure = _____ PSIG

Measured Liquid Line Temp = _____ ° F

14.3 Subcooling Charging Below 55° F Outdoor Temp. (In Heating Only)

The Subcooling Charging method in cooling is **not** recommended below 55° F outdoor temperature.

The only recommended method of charging at outdoor temperatures below 55° F is weighing in the charge in **heating mode**.

STEP 1 - Determine additional charge.

Note: The nameplate charge value represents the amount of refrigerant shipped in the outdoor unit and is compatible with 10 feet of AHRI rated refrigerant lines and the smallest AHRI rated coil.

Using the method below, find the charge associated with the additional length of tubing above 10 ft. and record it below.

Weigh-In Method can be used for the initial installation, or anytime a system charge is being replaced. Weigh-In Method can also be used when power is not available to the equipment site or operating conditions (indoor/outdoor temperatures) are not in range to verify with the subcooling charging method.

Calculating Charge Using the Weigh-In Method for the 3/8" liquid line

STEP 1 – Measure in feet the distance between the outdoor unit and the indoor unit. (Include the entire length of the line from the service valve to the IDU.) Subtract 10 ft from this entire length and record on line 1.

STEP 2 – Enter the charge multiplier (0.6 oz/ft). Each linear foot of interconnecting tubing requires the addition of 0.6 oz of refrigerant.

STEP 3 – Multiply the total length of refrigerant tubing (Line 1) times the value on Step 2. Record the result on Line 3 of the Worksheet.

STEP 4 – This is the amount of refrigerant to weigh-in prior to opening the service valves.

1. Total Line length (ft) – 10 ft _____
2. Charge multiplier x 0.6 oz
3. Step 1 x Step 2 = _____
4. Refrigerant (oz) = _____

STEP 2 - Stabilize the system by operating for a minimum of 20 minutes.

At startup, or whenever charge is removed or added, the system must be operated for a minimum of 20 minutes to stabilize before accurate measurements can be made.

STEP 3 - Check the liquid line temperature and liquid gage pressure to obtain a minimum of 10° subcooling in heating mode.

Measured Liquid Line Temp = _____ ° F

Liquid Gage Pressure = _____ PSIG

STEP 4 - Add charge if a minimum of 10° subcooling is not obtained with the namplate charge plus additional charge previously added.

STEP 5 - Return to site for adjustment.

Important: Return in the spring or summer to accurately charge the system in the cooling mode with outdoor ambient **above 55° F**.

Section 15. Checkout Procedures

15.1 Operational And Checkout Procedures

Final phases of this installation are the unit Operational and Checkout Procedures. To obtain proper performance, all units must be operated and charge adjustments made.

Important: Perform a final unit inspection to be sure that factory tubing has not shifted during shipment. Adjust tubing if necessary so tubes do not rub against each other when the unit runs. Also be sure that wiring connections are tight and properly secured.

CHECKOUT PROCEDURE

After installation has been completed, it is recommended that the entire system be checked against the following list:

- | | |
|--|--|
| 1. Leak check refrigerant lines. [] | 7. Be sure that indoor coil drain line drains freely. Pour water into drain pan..... [] |
| 2. Properly insulate suction lines and fittings..... [] | 8. Be sure that supply registers and return grilles are open and unobstructed..... [] |
| 3. Properly secure and isolate all refrigerant lines..... [] | 9. Be sure that a return air filter is installed..... [] |
| 4. Seal passages through masonry.
If mortar is used, prevent mortar from coming into direct contact with copper tubing..... [] | 10. Be sure that the correct airflow setting is used.
(Indoor blower motor) [] |
| 5. Verify that all electrical connections are tight..... [] | 11. Operate complete system in each mode to ensure safe operation..... [] |
| 6. Observe outdoor fan during on cycle for clearance and smooth operation..... [] | |

Section 16. Defrost Control

Defrost Control

The demand defrost control measures heat pump outdoor ambient temperature with a sensor located outside the outdoor coil. A second sensor located on the outdoor coil is used to measure the coil temperature. The difference between the ambient and the colder coil temperature is the difference or delta-T measurement. This delta-T measurement is representative of the operating state and relative capacity of the heat pump system. Measuring the change in delta-T determines the need for defrost. The coil sensor also serves to sense outdoor coil temperature for termination of the defrost cycle.

Fault Detection

A fault condition is indicated by the flashing Fault LED light on the defrost control board located inside the heat pump control box.

In normal operation, the status LED will flash once each second when idle or twice each second with a call for heating or cooling.

PIN Identification

1. TEST_COMMON (Shorting any of the other pins to this pin causes the function of the other pin to be executed. Leaving this pin open results in the normal mode of operation).
2. FRC_DFT = Forced Defrost (Short TEST_COMMON to this pin speeds up all defrost. Remove the short after defrost initiates).

Defrost Control Checkout

Normal operation requires:

- a. Status LED on board flashing 1 time/second in stand by or 2 times/second with a call for heating or cooling.
- b. 24V AC between R & B
- c. 24V AC between Y, Y0 & B with unit operating
- d. Defrost initiation when FRC_DFT pin is shorted to TEST_COMMON pin.

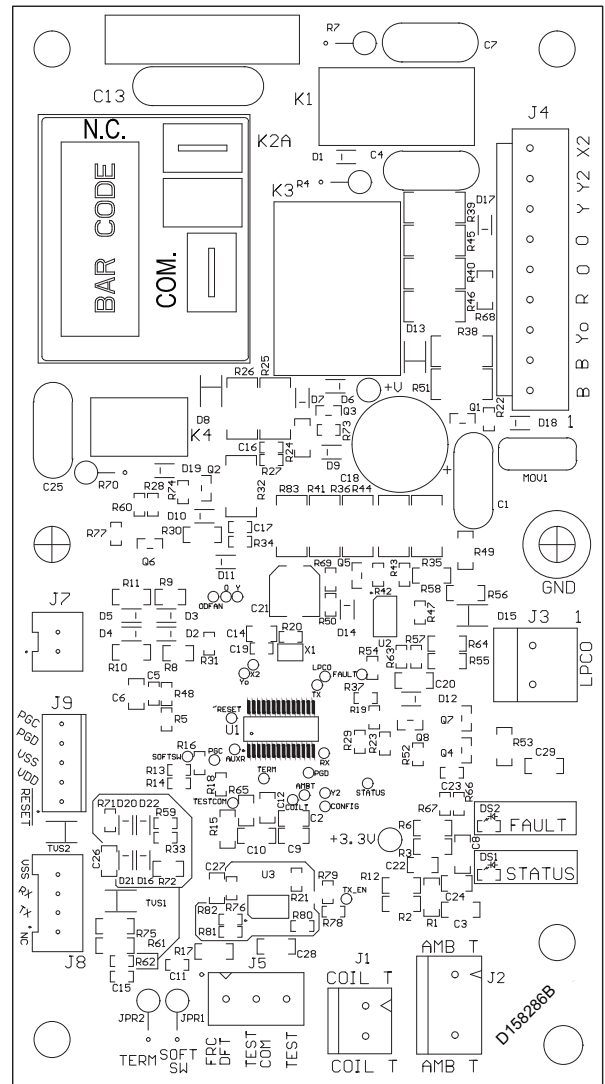

Test Sensors

Measure the temperature the subject sensor is exposed to. If the sensor is mounted on a tube, place the lead on an Annie A-8 (or equiv.) temperature tester on the same tube near the sensor and insulate the bulb.

Unplug the sensor and measure the resistance with a good quality ohmmeter (Simpson 260 or equiv.). Read the value as quickly as possible to prevent the meter current from changing the resistance reading.

Using the chart, locate (as close as possible) the actual sensor temperature. The measured resistance should be relatively close to the resistance value shown in the chart.

Table 1. Defrost Control Thermistor Table

TEMP °F	TEMP °C	THERMISTOR RESISTANCE (OHMS)	Volts DC
-15.00	-26.11	135976	2.50
-10.00	-23.33	115112	2.40
-5.00	-20.56	97745	2.29
0.00	-17.78	83247	2.17
5.00	-15.00	71108	2.05
10.00	-12.22	60916	1.93
15.00	-9.44	52333	1.81
20.00	-6.67	45076	1.69
25.00	-3.89	38927	1.56
30.00	-1.11	33703	1.45
35.00	1.67	29253	1.33
40.00	4.44	25452	1.22
45.00	7.22	22198	1.12
50.00	10.00	19405	1.02
55.00	12.78	17002	0.93
60.00	15.56	14930	0.85
65.00	18.33	13138	0.77
70.00	21.11	11586	0.70
75.00	23.89	10238	0.63
80.00	26.67	9065	0.57
85.00	29.44	8043	0.52
90.00	32.22	7150	0.47
95.00	35.00	6368	0.42
100.00	37.78	5682	0.38
105.00	40.56	5079	0.35
110.00	43.33	4548	0.31
115.00	46.11	4079	0.28
120.00	48.89	3665	0.26
125.00	51.67	3298	0.23
130.00	54.44	2972	0.21
135.00	57.22	2683	0.19

Example:

Sensor temp. = 19°F

Measured Resistance = 46K ohms

This sensor is good since the measured value is relatively close to the chart value.

COMPRESSOR	SCROLL	SCROLL
MNEMONIC NO CNT	CNT08177	CNT08176
GROUP NOMENCLATURE ^(a)	D161244G01	D161246G02
SUPERSEDURE CNT	07824	07825
OD FAN TYPE – PSC/ECM	PSC	ECM
	1-SPD	1-SPD

Table 2. DEMAND DEFROST QUICK SPECS

DEFROST ENABLED: Y = ON COIL TEMPERATURE	≤52 °F ^(b)	≤52 °F
DEFROST PERMIT: Y = ON COIL TEMPERATURE	≤32 °F	≤32 °F
MIN DEFROST TIME (MINUTES)	1	1
TARGET DEFROST TIME (MINUTES)	4	4
MAX TIME OVERRIDE (MINUTES +)	15	15
DEFROST TERMINATE COIL TEMPERATURE (Factory Setting)	47°F	47°F
DEFROST HI TERMINATE COIL TEMPERATURE (Cut Jumper 2)	70° F	70° F
SOV SWITCH-OVER DELAY AFTER DEFROST TERM. (SECONDS)	12	12
DEFEAT SWITCH-OVER DELAY (SECONDS) (Cut Jumper 1)	0	0
LOW AMBIENT HEAT PUMP LOCK OUT	-12°F	-12°F
LOW AMBIENT HEAT PUMP RESUME	-3	-3
LPCO INPUT TO CONTROL	YES	YES
LPCO BYPASS IN/OUT DEFROST (MINUTES)	3	3

(a) GROUP suffix for drawing number D

(b) ≤ (EQUAL OR LESS THAN)

Table 3. LED FAULT CODES

LED FAULT CODES	FAULT DESCRIPTION	DEFROST CONTROL BEHAVIOR
1 FLASH	Ambient Temp Sensor is out of range (open/shorted)	Initiate defrost after every 60 minutes of runtime. Defrost will terminate on coil temp. See Note 1 & 2.
2 FLASH	Coil Temp Sensor is out of range (open/shorted)	Initiate a 15 minute forced defrost after every 60 minutes of runtime. See Note 1 & 2.
3 FLASH	Low Pressure Switch is open	3 flash goes away when/if LPCO closes.

LED FAULT CODES	FAULT DESCRIPTION	DEFROST CONTROL BEHAVIOR
4 FLASH	Hard Lock Out (can only be cleared with a low voltage power cycle)	Occurs after 9 th trip of LPCO. See Note 6.
5 FLASH	Soft Lock Out	5 flash goes away after soft lockout period expires. See Note 2.
6 FLASH	Defrost cycles too close together	Heating short cycle fault triggers 6 flash. The system will follow 10 adaptive time heating cycles and then return to demand defrost.
9 FLASH	Low Ambient Soft Lockout. Outdoor temperature dropped below 3°F. (OFF at -12°F/ON at 3°F)	Outdoor temperature is below -12°F. See Note 5.

1. Initiate Adaptive/Timed Limp Mode so long as Coil Temp Sensor is functional. Monitor actual time in defrost and add or reduce run time until next forced defrost based on achieving a 4 minute (+/- 1) defrost period.
2. This defrost control utilizes a safety strategy called "Adaptive Limp Mode". Adaptive limp mode is defined as a timed heating mode following rapid defrosts (accumulated heating times between defrost totaling less than 15 minutes). Once invoked the DFC will limit defrost periods and maximize heating capacity. While in adaptive limp mode the DFC will monitor heating and defrost periods for no longer than 10 cycles. The DFC will then release the board to demand defrost; however, if the LPCO trips while in limp mode the system will initiate a soft lockout and exit limp mode.
If both Coil Temp Sensor and Ambient Temp Sensor have failed, initiate a 5 minute forced defrost every 60 minutes of run time. This in conjunction with the normal low pressure trip, will initiate a soft lockout.
 - a. A short heating cycle that enters defrost in 15 minutes or less and/or enters two more defrosts with less than 15 minutes of accumulative run time each will enter an Adaptive Limp Mode (6 Flash).
 - b. Coil sensor failure will initiate a Timed Limp Mode. This will be accompanied by a 2 flash. The DFC will initiate defrost after 60 minutes of accumulated heating runtime and terminate after a 5 minute defrost. The limp mode will clear after the sensor fault is cleared.
 - c. Ambient sensor failure will initiate an Adaptive

Timed Limp Mode. This will be accompanied by a 1 flash. The DFC will initiate defrost after 60 minutes of accumulated heating runtime and force a defrost, which will terminate on coil temp. The limp mode will clear after the sensor fault is cleared.

- d. This could be caused by a condenser fan motor failure, low charge or other reasons.
3. The first 15 minute soft lockout the system will return to normal operation. Should this continue to operate in this manner there will be a 30 minute soft lockout and so on. At the end of the lockout process, if a hard lock is necessary, a 4 flash will be announced and system operation is interrupted. If the ambient temperature climbs above 40°F for more than 30 minutes this clears this fault count and resumes normal operation.
 - a. If or when normal operation is restored after the ambient temperature climbs above 40°F for more than 30 minutes and another LP trip is monitored on the 9th trip this will initiate a hard lockout that will not be cleared by temperature or time.
4. Once ambient drops to -12 or lower wait 5 minutes before soft lockout begins. During soft lockout the Y signal passes through to the X2 output. Resume operation when ambient temperature rises to -3°F or higher and after 5 minute soft lockout period expires. LPCO should reset around 5°F.
5. During a Hard Lockout, the X2 relay opens so that the Y signal does not pass through.

LPCO	HEATING Mode	Flash Code
1 st Trip	15 minute soft lock-out period	5 and 6 flash
2 nd Trip	30 minute soft lock-out period	5 and 6 flash
3 rd Trip	45 minutes soft lock-out period	5 and 6 flash
4 th – 8 th Trip	18 hour soft lock-out period	5 and 6 flash
9 th Trip ^(a)	Hard lock-out	4 flash

^(a) If LPCO is open, a 3 flash can accommodate any of the faults above and will clear when the LPCO closes.

LPCO	HEATING Mode	Flash Code
1 st Trip	15 minute soft lock-out period	5 and 6 flash
2 nd Trip	30 minute soft lock-out period	5 and 6 flash
3 rd Trip	45 minutes soft lock-out period	5 and 6 flash
4 th – 8 th Trip	18 hour soft lock-out period	5 and 6 flash
9 th Trip ^(a)	Hard lock-out	4 flash

Note: Once the LPCO closes, the 3 flash fault will not continue showing – only 5 flash if in the softlockout period.

Section 17. Troubleshooting

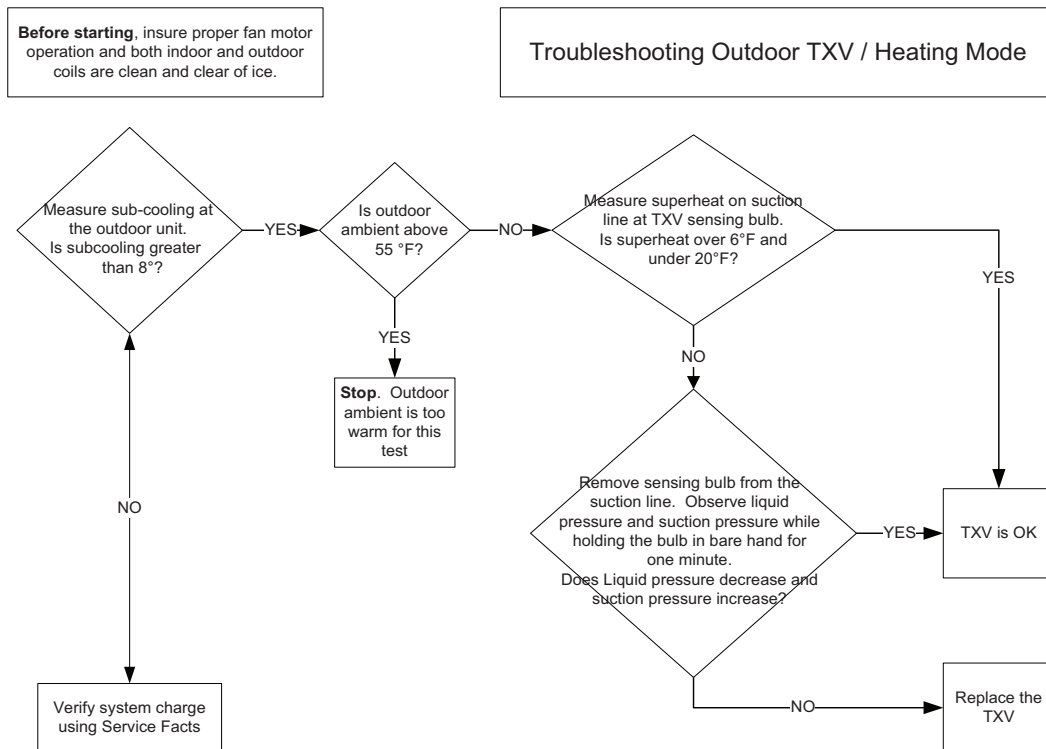
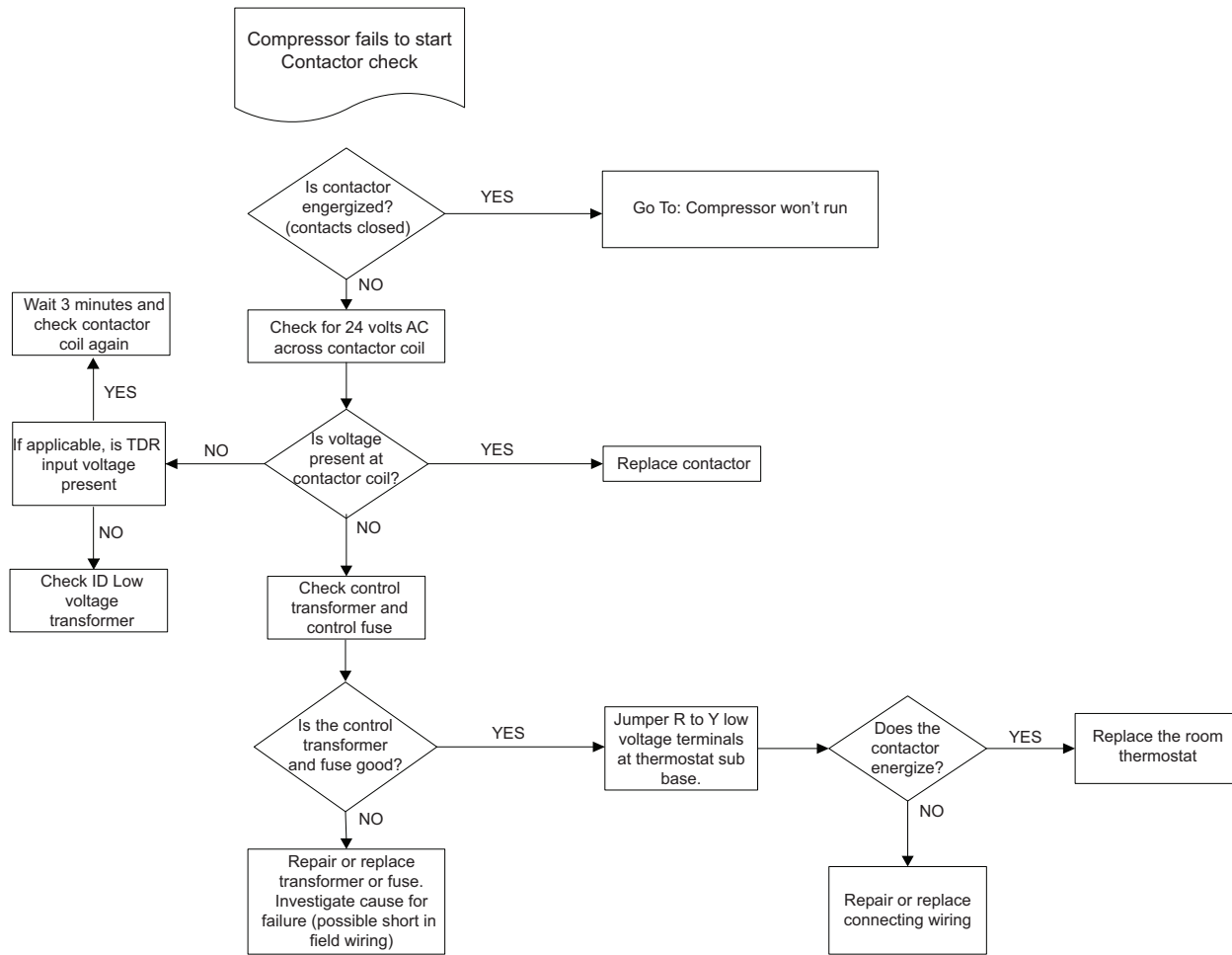

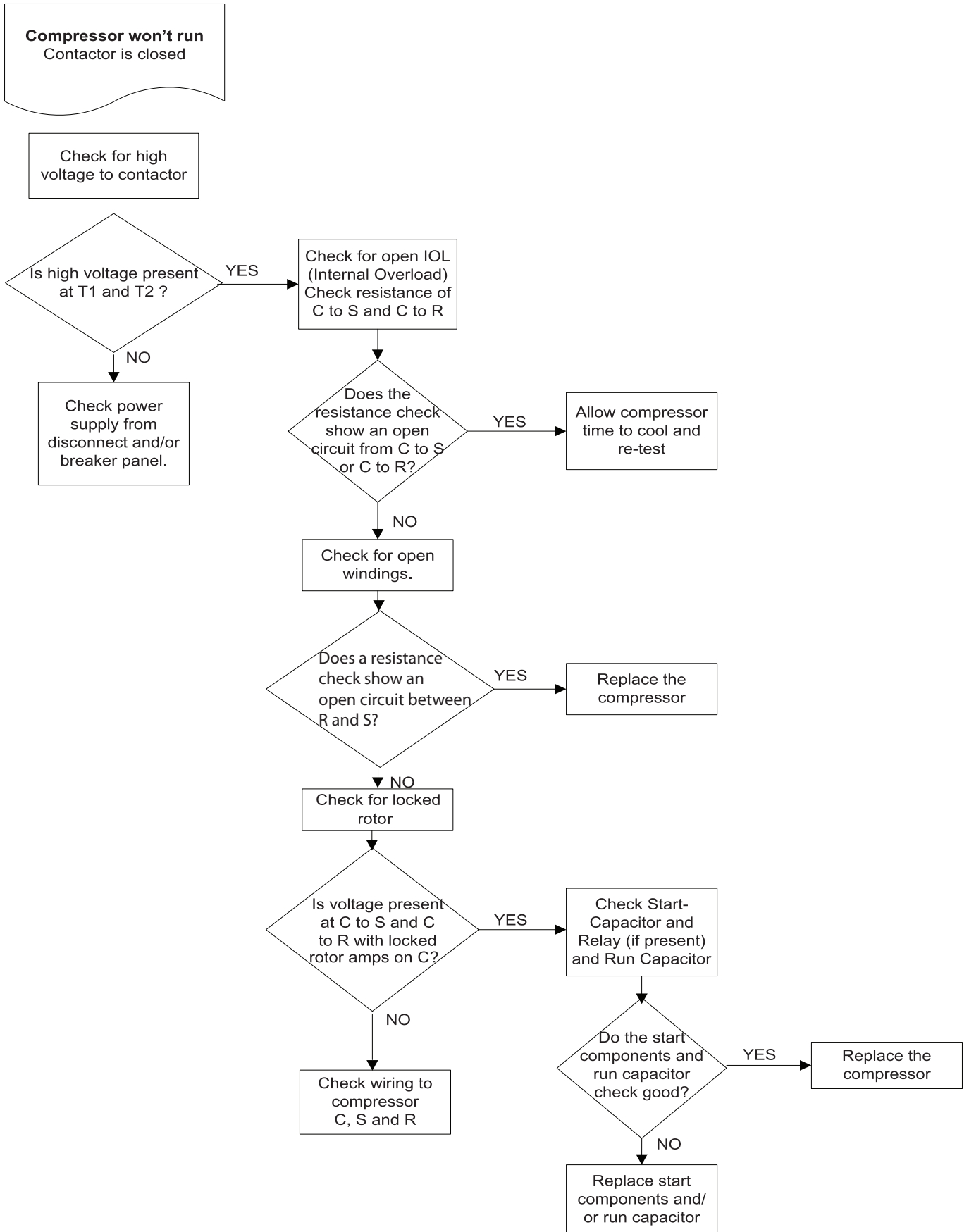

Section 18. Wiring Diagrams

Wiring Diagram – 017N, 042N, 048N & 060N Models

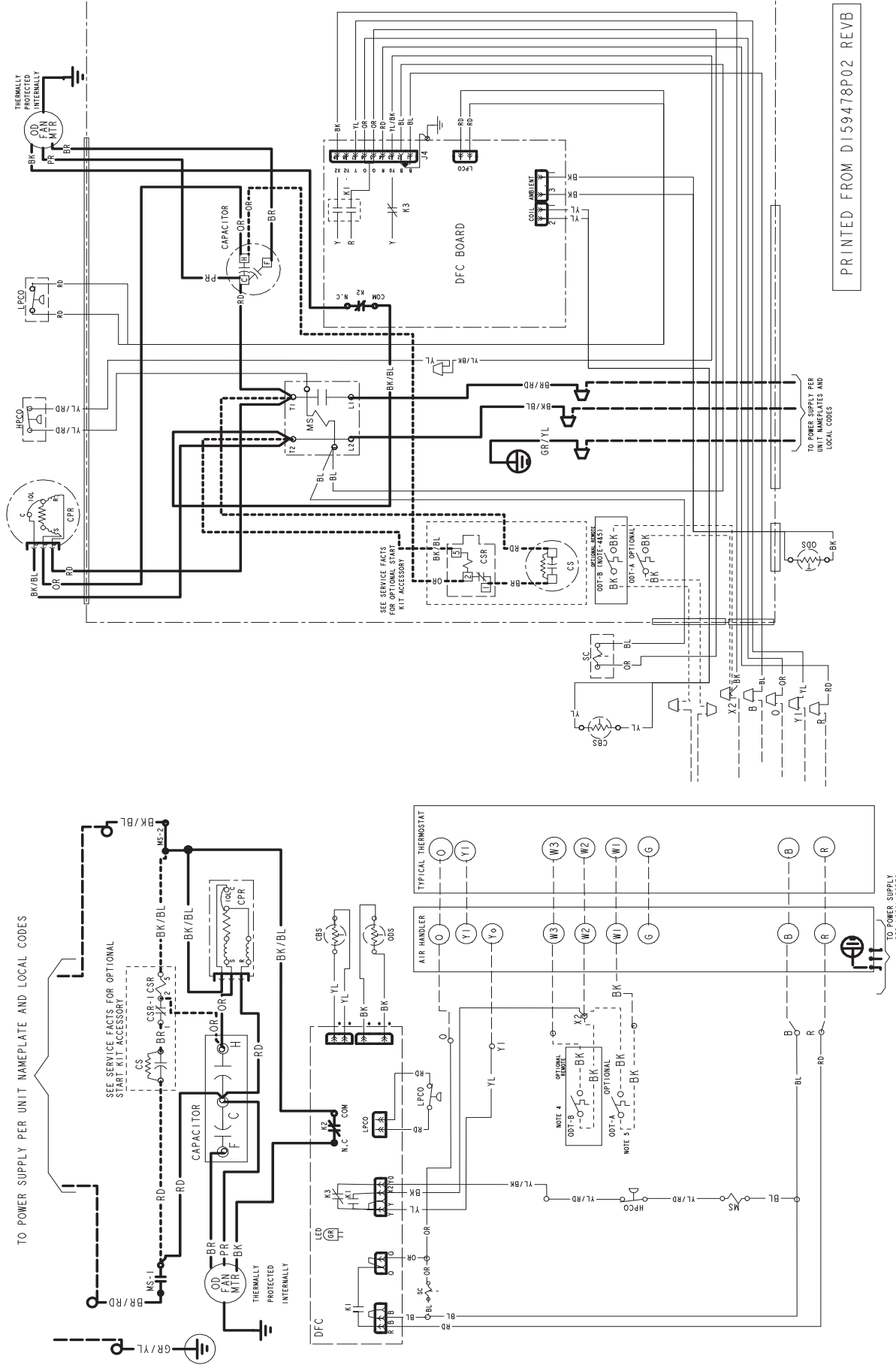

Wiring Diagram – 018N, 024N, 030N & 036N Models

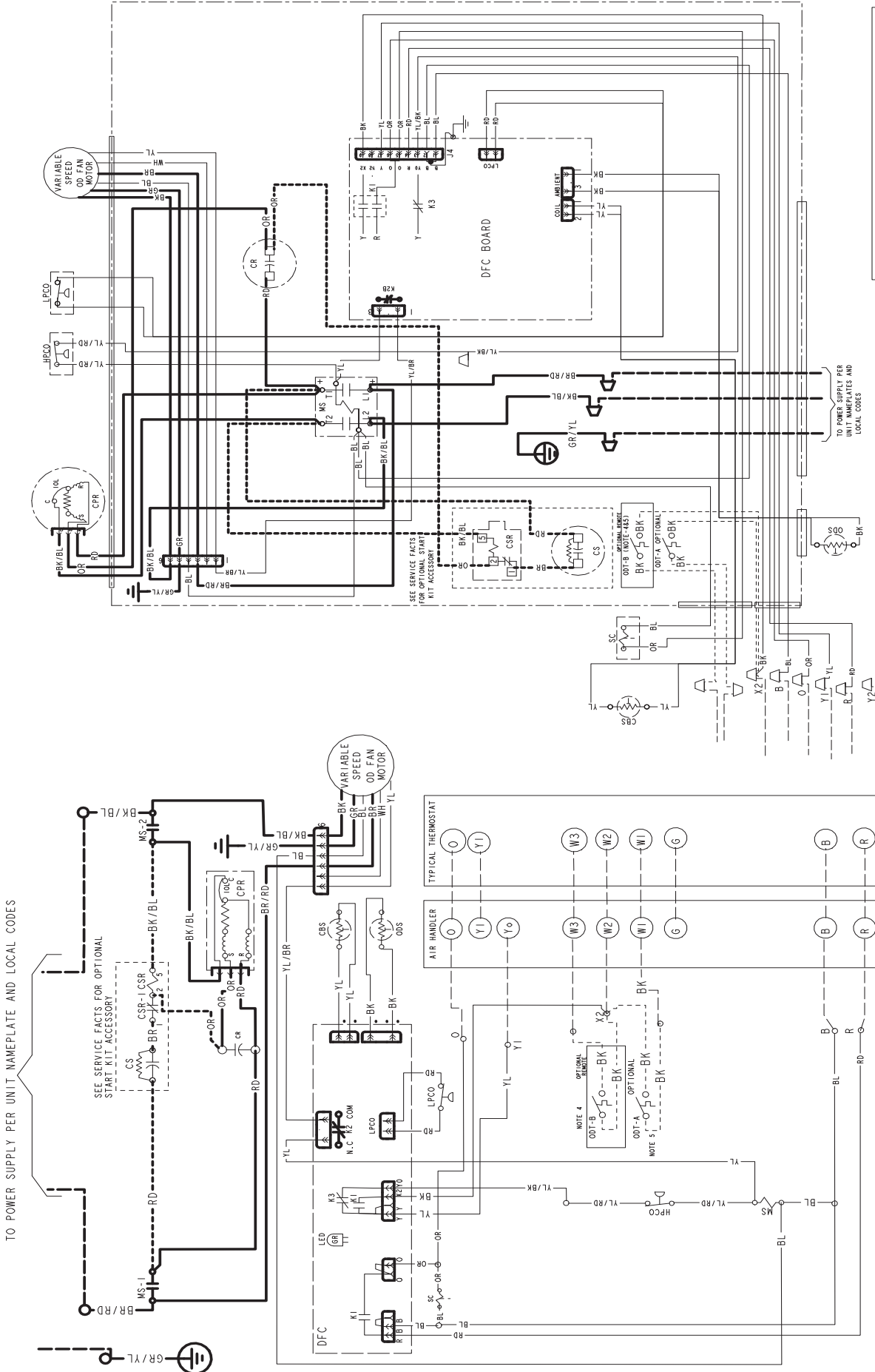

PRINTED FROM D158596P05 REV.C

NOTES:

1. BE SURE POWER SUPPLY AGREES WITH EQUIPMENT NAMEPLATE.
2. POWER WIRING AND GROUNDING OF EQUIPMENT MUST COMPLY WITH LOCAL CODES.
3. LOW VOLTAGE WIRING TO BE NO. 18 AWG MINIMUM CONDUCTOR.
4. ODT-B MUST BE SET LOWER THAN ODT-A
5. IF ODT-A IS NOT USED, ADD JUMPER BETWEEN W1 AND W2 AT AIR HANDLER

LEGEND

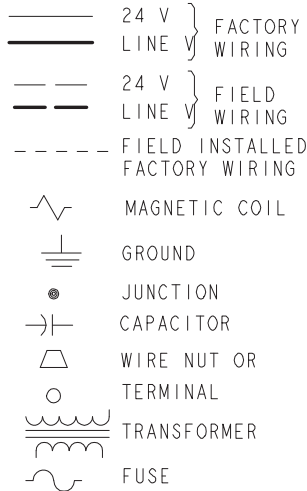

□ TERMINAL BLOCK/BOARD

- ACR A/C RECTIFIER
- CBS COIL BOTTOM SENSOR
- CF FAN CAPACITOR
- CN WIRE CONNECTOR
- CPR COMPRESSOR
- CR RUN CAPACITOR
- CS STARTING CAPACITOR
- CSR CAPACITOR SWITCHING RELAY
- DFC DEFROST CONTROL
- EEV ELECTRONIC EXP VALVE
- EEVC ELECTRONIC EXP VALVE CONTROL
- F INDOOR FAN RELAY
- HPCO HIGH PRESSURE CUTOFF SWITCH
- IOL INTERNAL OVERLOAD PROTECTOR
- LPCO LOW PRESSURE CUTOFF SWITCH
- MS COMPRESSOR MOTOR CONTACTOR
- ODA OUTDOOR ANTICIPATOR
- OFT OUTDOOR FAN THERMOSTAT
- ODS OUTDOOR TEMPERATURE SENSOR
- ODT OUTDOOR THERMOSTAT
- P-TRD PRESSURE TRANSDUCER
- SC SWITCH OVER VALVE SOLENOID
- SM SYSTEM ON-OFF SWITCH
- TDL DISCHARGE LINE THERMOSTAT
- TDR TIME DELAY RELAY (5 SEC DELAY ON)
- TNS TRANSFORMER
- TEMP SENSOR, TEMPERATURE
- Y2C HIGH CAPACITY CONTROL RELAY

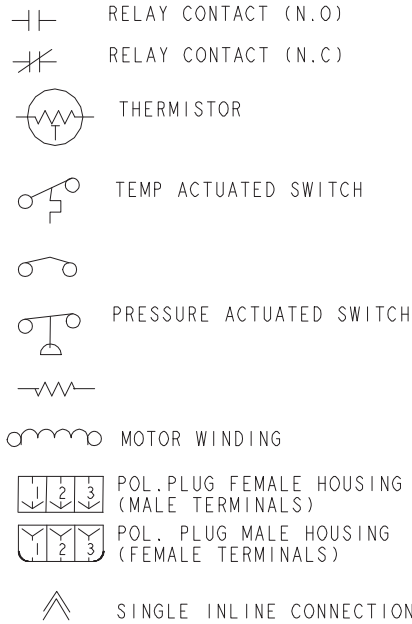

CAUTION

USE COPPER CONDUCTORS ONLY!
 UNIT TERMINALS ARE NOT DESIGNED TO ACCEPT OTHER TYPES OF CONDUCTORS.
 Failure to do so may cause damage to the equipment.

WARNING

HAZARDOUS VOLTAGE!
 DISCONNECT ALL ELECTRICAL POWER INCLUDING REMOTE DISCONNECTS BEFORE SERVICING.
 Failure to disconnect power before servicing can cause severe personal injury or death.

FOR CANADIAN INSTALLATIONS
 POUR INSTALLATIONS CANADIENNES

CAUTION: NOT SUITABLE FOR USE ON SYSTEMS EXCEEDING 150V-TO-GROUND
 ATTENTION: NE CONVIENT PAS AUX INSTALLATIONS DE PLUS DE 150 V A LA TERRE

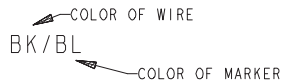

- BK BLACK RD RED OR ORANGE
- BL BLUE WH WHITE GR GREEN
- BR BROWN YL YELLOW PR PURPLE
- PK PINK

Section 19. Pressure Curves

COOLING PERFORMANCE CAN BE CHECKED WHEN THE OUTDOOR TEMP IS ABOVE 65 DEG F.

TO CHECK COOLING PERFORMANCE, SELECT THE PROPER INDOOR CFM, ALLOW PRESSURES TO STABILIZE. MEASURE INDOOR WET BULB TEMPERATURE, OUTDOOR TEMPERATURE, DISCHARGE AND SUCTION PRESSURES. ON THE PLOTS LOCATE OUTDOOR TEMPERATURE (1); LOCATE INDOOR WET BULB (2); FIND INTERSECTION OF OD TEMP. & ID W.B. (3); READ DISCHARGE OR SUCTION PRESSURE IN LEFT COLUMN (4).

EXAMPLE: (1) OUTDOOR TEMP. 82 F.

(2) INDOOR WET BULB 67 F.

(3) AT INTERSECTION

(4) DISCHARGE PRESSURE @ 670 CFM IS 318 PSIG.

(5) SUCTION PRESSURE @ 670 CFM IS 149 PSIG.

ACTUAL:

DISCHARGE PRESSURE SHOULD BE +/- 10 PSI OF CHART

SUCTION PRESSURE SHOULD BE +/- 3 PSIG OF CHART

PRESSURE CURVES FOR 4TWR4017N1

TEM4A0B18S21+TDR

Cooling @ 670 SCFM

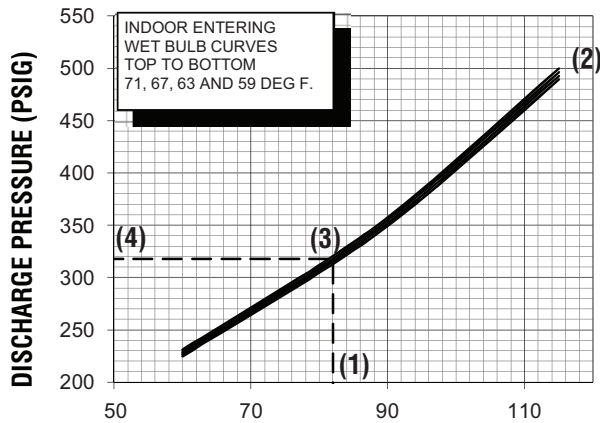

TEM4A0B18S21+TDR

Heating @ 670 SCFM

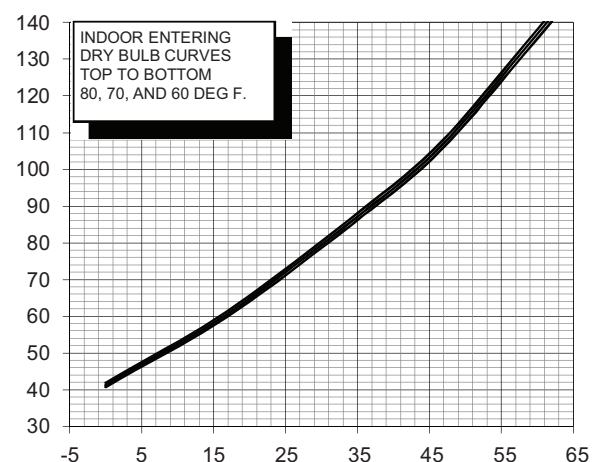
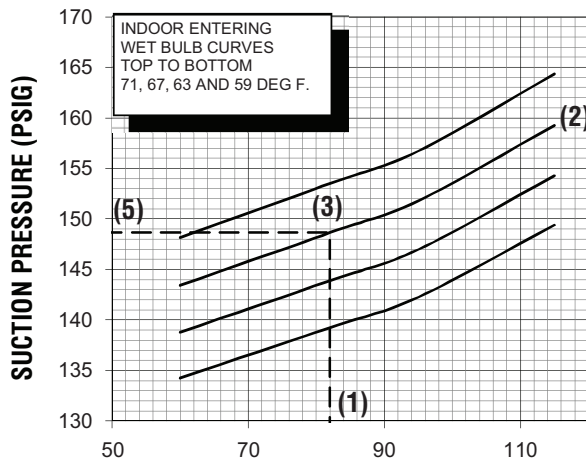
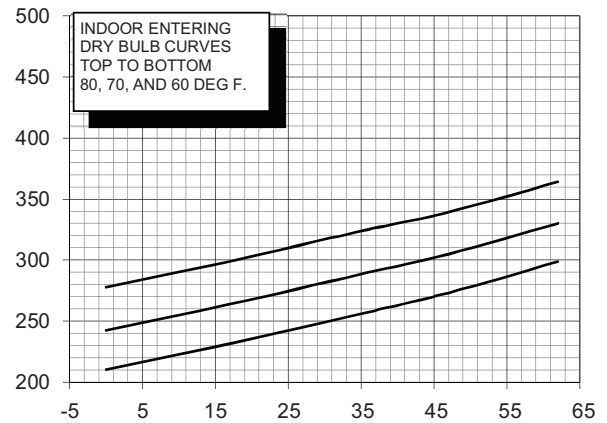

OUTDOOR TEMPERATURE (Degree F)

PRESSURE CURVES FOR 4TWR4018N1

TAM9A0B30V31
Cooling @ 900 SCFM

TAM9A0B30V31
Heating @ 850 SCFM

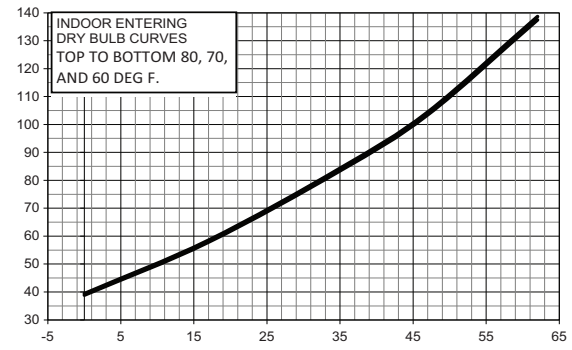
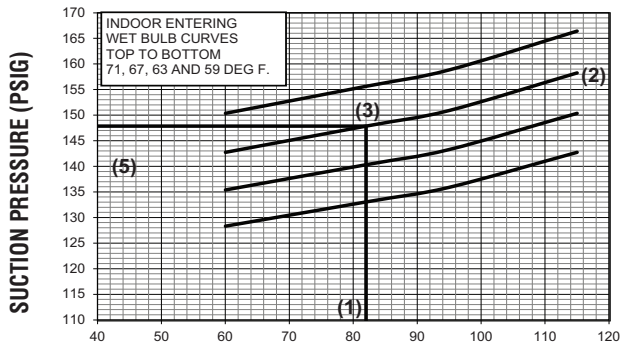
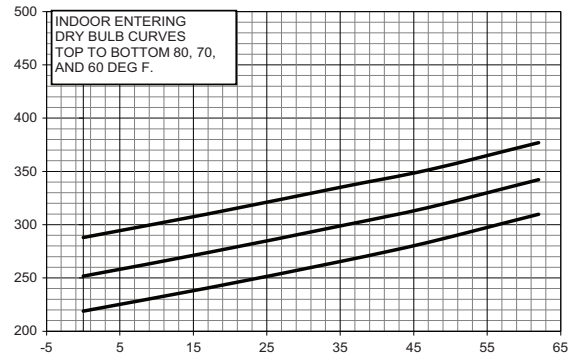
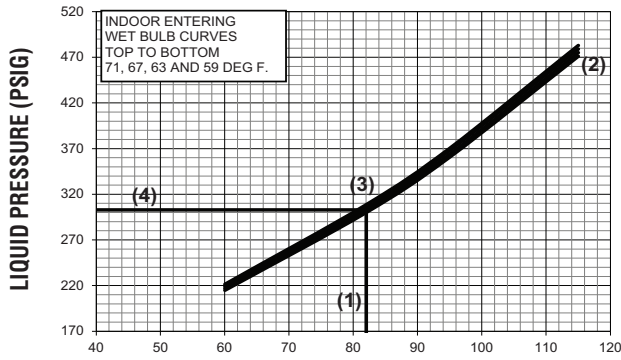

OUTDOOR TEMPERATURE (Degree F)

PRESSURE CURVES FOR 4TWR4024N1

TAM9A0B30V31
Cooling @ 900 SCFM

TAM9A0B30V31
Heating @ 850 SCFM

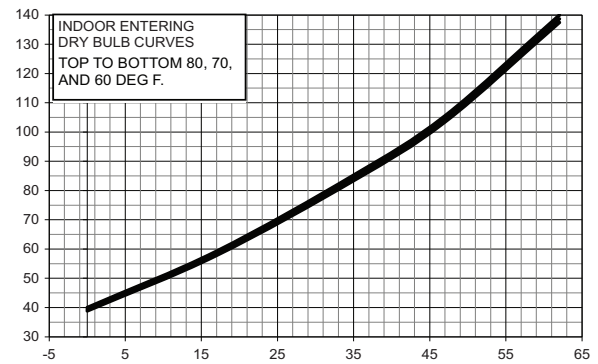
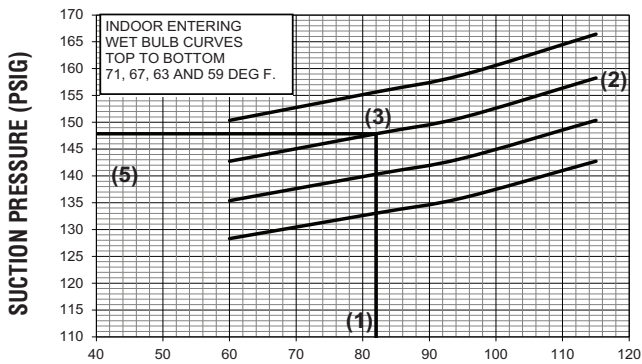
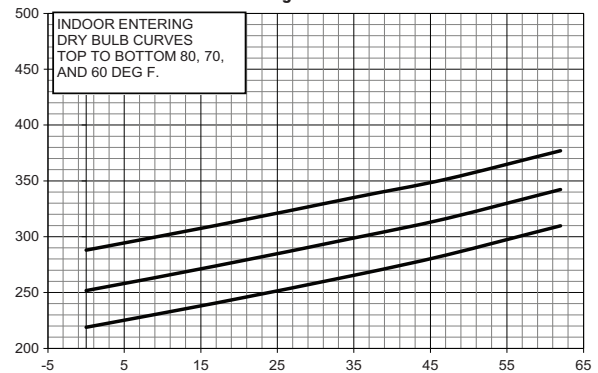
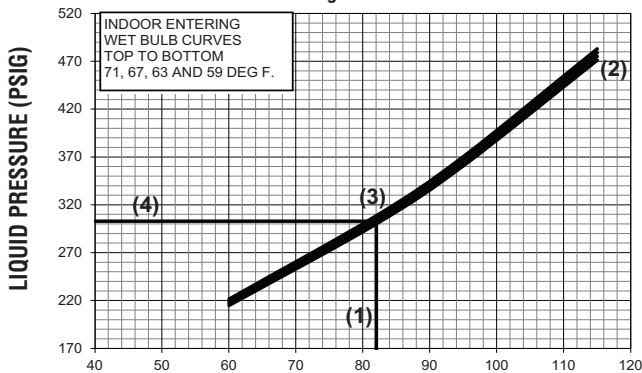

OUTDOOR TEMPERATURE (Degree F)

PRESSURE CURVES FOR 4TWR4030N1

TAM9A0B30V31DAB
Cooling @ 850 SCFM

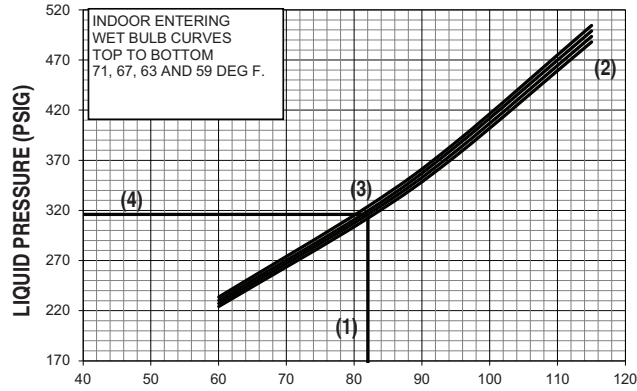

TAM9A0B30V31DAB
Heating @ 850 SCFM

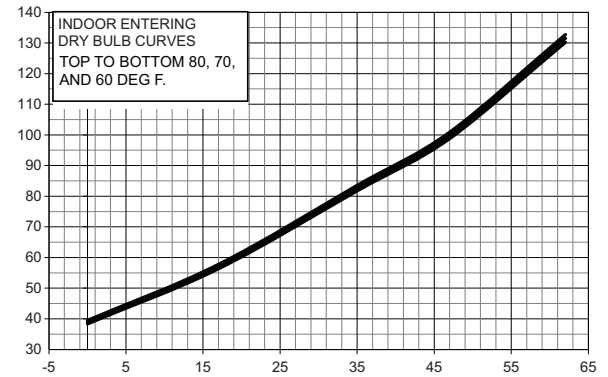
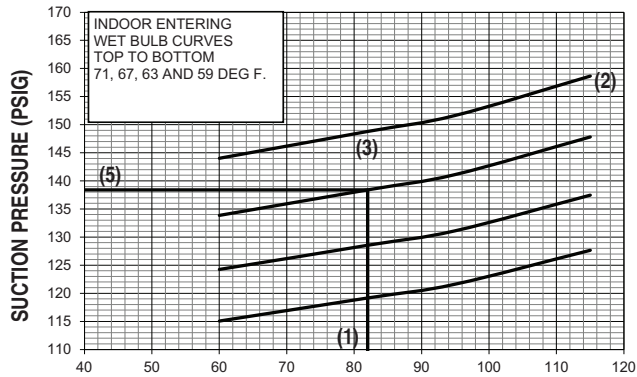
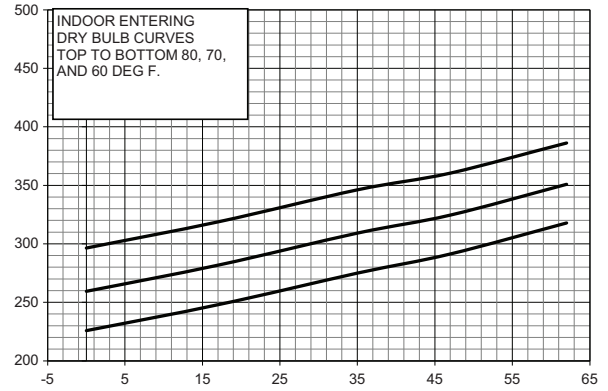

OUTDOOR TEMPERATURE (Degree F)

PRESSURE CURVES FOR 4TWR4036N1

TEM6A0C36H31
Cooling @ 1100 SCFM

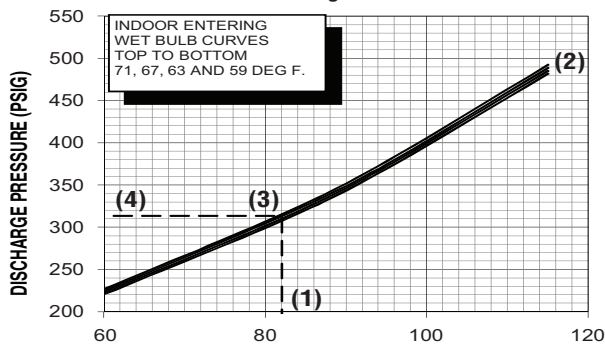

TEM6A0C36H31
Heating @ 1250 SCFM

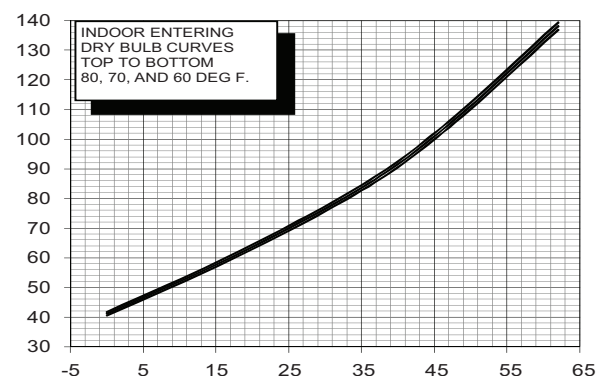
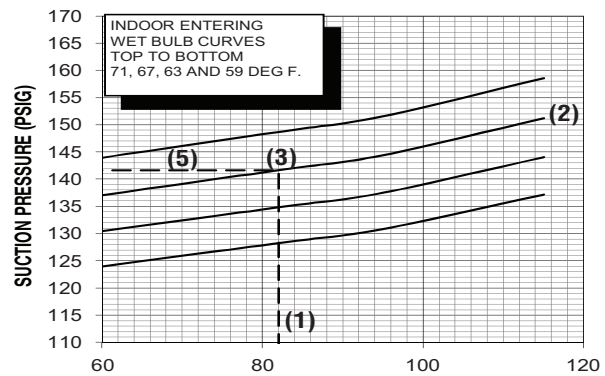
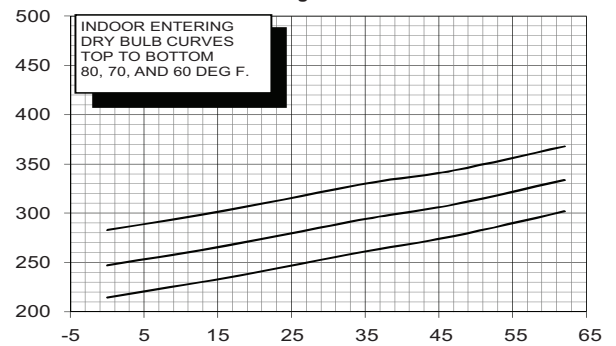

OUTDOOR TEMPERATURE (Degree F)

PRESSURE CURVES FOR 4TWR4042N1

TEM6A0C42H41

Cooling @ 1250 SCFM

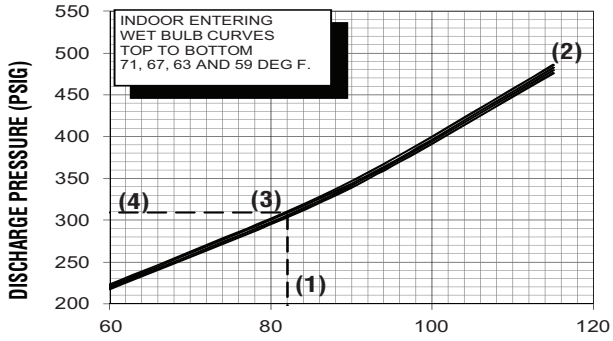

TEM6A0C42H41

Heating @ 1300 SCFM

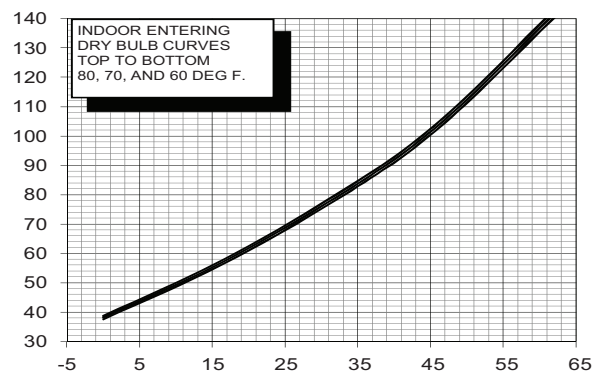
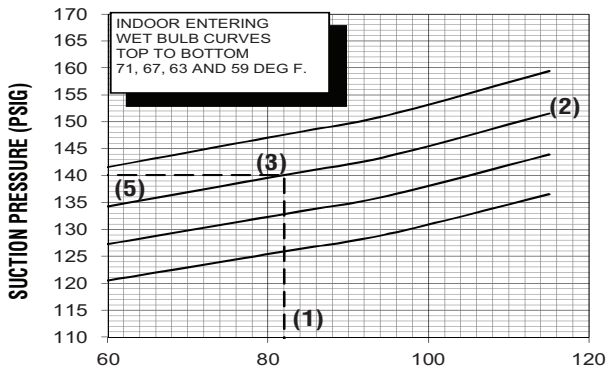
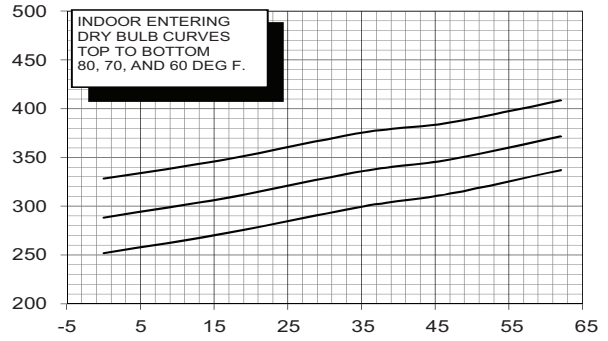

OUTDOOR TEMPERATURE (Degree F)

PRESSURE CURVES FOR 4TWR4048N1

TEM6A0D48H41

Cooling @ 1400 SCFM

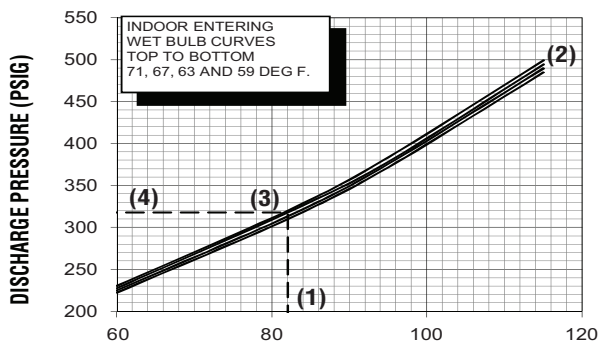

TEM6A0D48H41

Heating @ 1450 SCFM

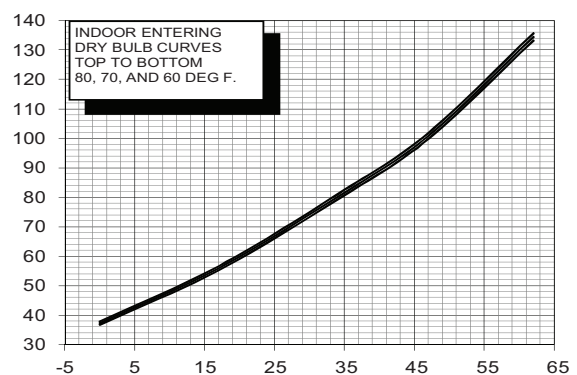
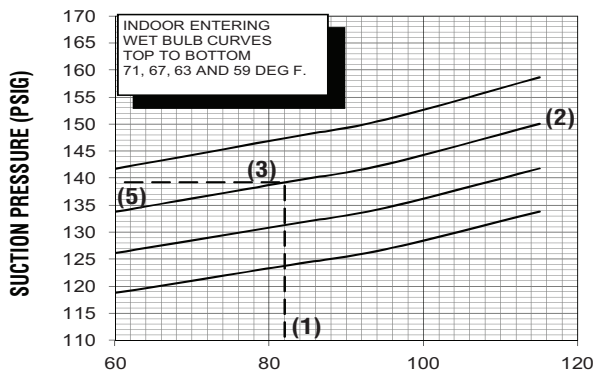
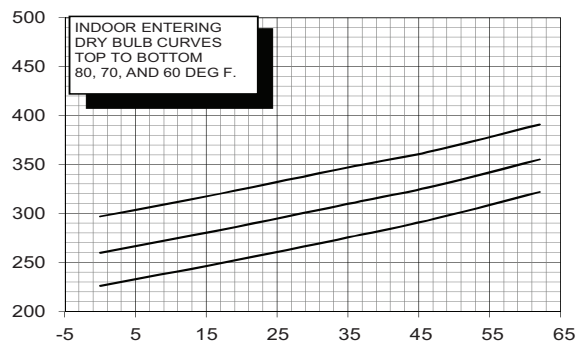

OUTDOOR TEMPERATURE (Degree F)

PRESSURE CURVES FOR 4TWR4060N1

TEM6A0D60H51

Cooling @ 1450 SCFM

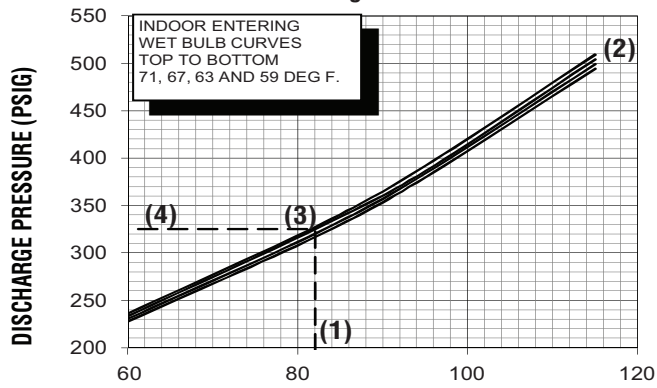

TEM6A0D60H51

Heating @ 1550 SCFM

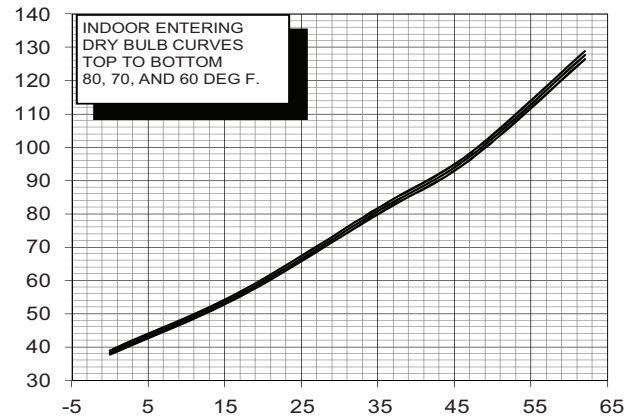
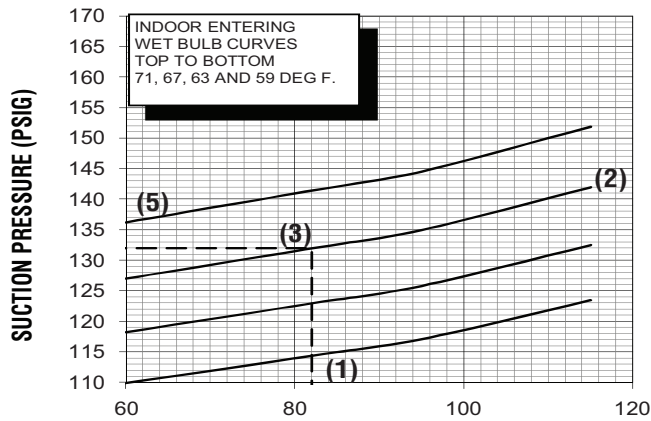
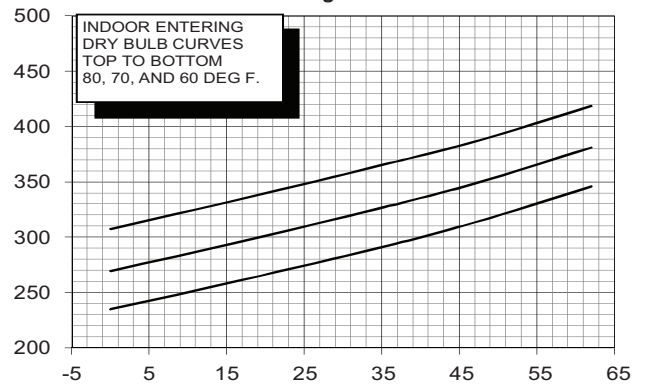

OUTDOOR TEMPERATURE (Degree F)

Section 20. Refrigerant Circuit (only for reference)

Heating Refrigeration Cycle

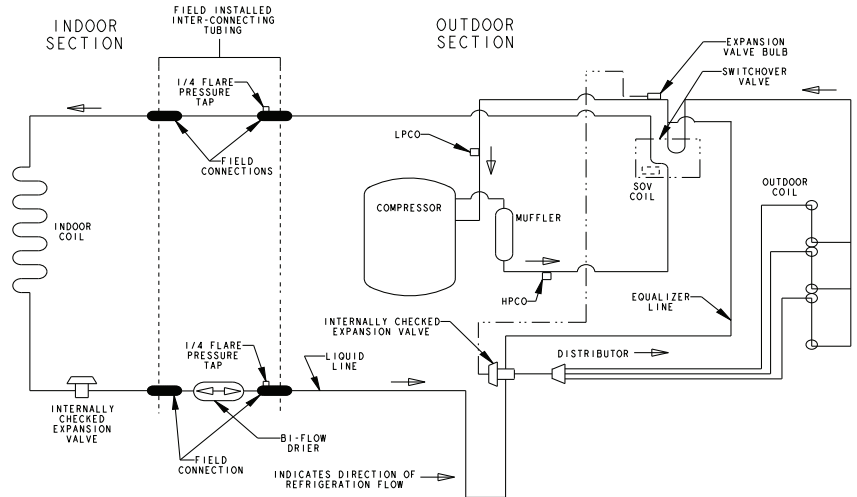

Cooling Refrigeration Cycle

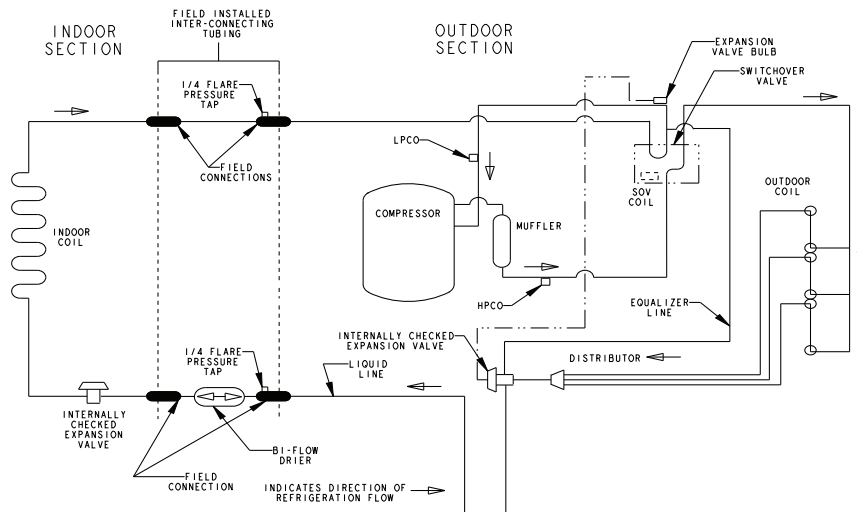

Printed from D159360



Trane - by Trane Technologies (NYSE: TT), a global climate innovator - creates comfortable, energy efficient indoor environments for commercial and residential applications. For more information, please visit trane.com or tranetechnologies.com.



The AHRI Certified mark indicates Trane U.S. Inc. participation in the AHRI Certification program. For verification of individual certified products, go to ahridirectory.org.



Trane has a policy of continuous data improvement and it reserves the right to change design and specifications without notice. We are committed to using environmentally conscious print practices.