



Product Catalog

Water Source Heat Pump Axiom™ High Efficiency Vertical Stack – GET

0.75 to 3 Tons — 60 Hz





Introduction

Water-Source Vertical High-Rise

The 0.75 ton through 3 ton vertical high-rise water-source heat pump is a floor mounted, “furred-in” unit, designed to be hidden from view behind drywall to blend with the room’s natural decor. In multi-story buildings, the units may be stacked one on top of the other to minimize piping and electrical costs. Supply, return and condensate riser piping may be factory mounted to simplify job site installation of the equipment.

The high-rise configuration is often used in hotels, dorms and assisted living facilities where a single unit could provide comfort to a single or multiple room dwelling. Since the units are mounted directly in the space, ductwork is optional.

All water-source heat pumps are commissioned, tested and quality certified prior to leaving the factory. This assures global quality standards from controls, water, refrigeration, and aesthetics to the building owner and installing contractor.

Copyright

This document and the information in it are the property of Trane, and may not be used or reproduced in whole or in part without written permission. Trane reserves the right to revise this publication at any time, and to make changes to its content without obligation to notify any person of such revision or change.

Trademarks

All trademarks referenced in this document are the trademarks of their respective owners.

Revision History

- Added Symbio™ 400-B controller.
- Removed ZN510 controller.
- Updated programmable zone sensors table in Thermostats and Zone Sensors chapter.
- Updated Water Flow Control section in Dimensional Data chapter.



Table of Contents

Features and Benefits	4
Key Features	4
Application Considerations	8
Selection Procedures	15
Model Number Descriptions	16
General Data	18
Performance Data	19
Unit Fan Performance	40
Controls	46
Deluxe 24 V Electronic Controls	46
Symbio™ 400-B/Tracer® UC400-B	47
Trane Air-Fi® Wireless Systems	49
Thermostats and Zone Sensors	50
Electrical Data	53
Dimensional Data	54
Mechanical Specifications	67



Features and Benefits

Key Features

- Removable/replaceable chassis
- Ducted and free discharge cabinet selections available
- Factory mounted flow control with strainer and isolation valve option
- Plug-in chassis and plug-in thermostat design
- Factory supplied riser options
- Maintenance accessibility for coil fin cleaning
- Extra quiet design includes enhanced and deluxe sound proofing choice
- Through the front high and low pressure service ports accessible
- Hinged return air door with a magnetic catch, hex key or key lock option. Tamper resistant hinged acoustical door option.
- Unit mounted on/off switch and fuse option
- Lower height cabinet for ducted applications
- Auxiliary drain pan
- Corrosion resistant chassis drain pan
- Intelligent controls

Figure 1. Auxiliary drain pan



Unit Description

The vertical high-rise water-source heat pump is a floor mounted configuration available in a 0.75 ton, 1 ton, 1.25 ton, 1.5 ton, 2 ton and 3 ton sizes.

The unit cabinet may be ordered for early shipment to aid in early installation of drywall, plumbing and electrical. The cabinet design is available in an 88 or 94-inch height (free discharge) or an 80 or 86-inch height (ducted) configuration. As many as 3 supply-air discharges are available for the 1.25 ton to 3 ton, free discharge cabinets to provide multiple supply-air through one unit.

Air distribution is made through a rigid bar type extruded aluminum grille mounted to the sheetrock. It is both durable and attractive in design.

The return-air panel is a hinged acoustical door. The door allows for easy access to the unit's filter and for maintenance of the equipment.

Figure 2. Return-air flush mounted hinged door



The hinged acoustical panel provides greater sound attenuation, and is mounted flush to the wall. This panel is easily removed for filter maintenance or chassis removal through the magnetic catch door. An optional hex key or key lock latch are available on the hinged door design to impede access if required.

Blower/Motor Assembly

The blower/motor assembly of the unit includes double width, double inlet (DWDI) blower with direct drive PSC motor or optional ECM for improved efficiency and power factor. It may be easily removed for cleaning or service after removal of the unit chassis. The PSC motor is a multi-speed design, factory wired to high speed or low speed (order specific). The tap is wired and capped inside the unit control box for easy field convertibility. The ECM is programmed to provide four constant CFM profiles and is shipped on Profile B – the rated CFM of the unit. To change the PSC speed tap or the ECM CFM profile, see installation manual for instructions.

Controls

Standard controls include a 24 V, micro-processor deluxe controller for a wall-mounted thermostat option. The thermostat is typically placed above the return-air door. Even though the thermostat is considered to be unit mounted, the thermostat is mounted to the dry-wall that covers the front of the unit.

Thermostat selections are provided in the Thermostat and Zone Sensor Section section of the catalog. They are available in manual or automatic changeover options.

The deluxe controller includes relays for: anti-short cycle compressor protection, random start delay, brown-out protection low pressure time delay, compressor delay on start and night setback control. These extended control features offer greater system performance to extend the equipment's life.

The Symbio™ 400-B/Tracer® UC400-B controller (options) are provided on the vertical stack design for direct digital control (DDC) systems. This controller offers the building owner innovative ways to optimize heating and cooling energy for the building. Faults and sensors include: random start delay, heating/cooling status, occupied/unoccupied mode, and filter status.

The Symbio 400-B/UC400-B controller may also be applied with the Tracer® SC or other BAS system to complete a building management system.

Non-fused switch and fused entrance block may be factory added to the equipment to save installation time of these components in the field where local building codes allow.



Features and Benefits

Trane® Air-Fi® Wireless Systems

Trane Air-Fi wireless systems provides significant advantages to better meet customer by providing a lower initial cost; ease of installation for reduced risk; increased reliability and flexibility for easier problem solving; and fewer maintenance issues for worry-free operation and cost savings over the life of the system. Trane Air-Fi wireless systems helps save time and money, with industry-leading technology and performance.

Deluxe 24 V Electronic Controls

General alarm is accomplished through the lockout relay and is used to drive light emitting diodes. This feature will drive dry contacts only, and may not be used to drive field installed control inputs.

Factory Installed Flow Control

Optional factory mounting of the isolation valve and flow control valves is available to speed field equipment installation, and help provide optimum water flow balancing support.

Refrigeration Section

The unit's compressor is a highly efficient, hermetically sealed with internal vibration isolation. External isolation is provided between the compressor and mounting plate to help reduce radiated noise that is typically associated with compressor start.

The air-to-refrigerant coil is easily accessible for cleaning purposes behind the unit's removable return-air door/panel.

The water-to-refrigerant coil is a copper or cupro-nickel (option) co-axial tube-within-a-tube design. The inner-water tube is deeply fluted to enhance heat transfer and minimize fouling and scaling. The outer refrigerant gas tube is made from steel material. The coil is leak tested to assure there is no cross leakage between the water tube and the refrigerant gas (steel tube) coil. The ½" (009/012/015/018) and ¾" (024/036) threaded water connections to the water-coil are available on the exterior chassis top. A flexible hose connection with shut-off is typically used between the riser and water-coil in/out connections on the chassis to reduce water vibration.

The refrigerant flow metering is made through a thermal expansion valve (TXV). The TXV allows the unit to operate with an entering fluid temperature from 25°F to 120°F, and an entering air temperature from 55°F to 85°F. The valve precisely meters refrigerant flow through the circuitry to achieve desired heating or cooling.

Unlike cap-tube assemblies, the TXV allows the exact amount of refrigerant required to meet the coil load demands. This precise metering increases the over-all efficiency of the unit.

The unit's reversing valve is piped to be energized in the cooling mode. All vertical high-rise units ship in a heat pump configuration with a system reversing valve.

Supply/Return/Condensate Risers

Supply, return and condensate risers are available as a factory mounted and shipped option. The risers are constructed from type L or M copper. The top of each riser is swaged to accept the same size diameter riser from above. This helps facilitate installation of the water supply, return and condensate to and from the unit. Insulation may be factory installed or field installed per order selection. The insulation helps keep moisture from forming on the pipes and damaging building construction.

The riser length may be ordered as standard in 96" to 120" lengths. See Equipment Risers in the Application Considerations section for riser application information.

Unit Safety

All unit safety devices are provided to help prevent compressor damage. Low pressure switch and high pressure switch are added to help protect the compressor operation under a low charge (40 psig) or during high discharge (650 psig) pressures. In cases where a low charge, or excessive loss of charge occurs, each compressor comes equipped with an overload device to halt the compressor operation.

Features and Benefits

A safety lockout provides the mechanical communication of the low and high pressure switches to prevent compressor operation if the unit is under low or high refrigerant pressures, or during a condensate overflow condition. The lockout relay may be reset at the thermostat, by cycling power to the unit.

Application Considerations

Advantages of Geothermal

The advantages of a geothermal heat pump system can literally decrease heating and cooling operating costs by 30%- 40%. The units are durable, and typically last longer than conventional systems. They are protected from harsh outdoor weather conditions, because the unit is installed indoors and the loop underground. According to ASHRAE, the estimated service life for a commercial water-to-air heat pump is 19 years.

Geothermal heat pumps have fewer mechanical components, making them more reliable and less prone to failure.

Geothermal heat pumps work toward the preservation of the environment by reducing the environmental impacts of electric power generation.

Flexibility

The vertical, high-rise water-source heat pump system is versatile for installation in boiler/cooling tower applications, as well as ground-source (geothermal) applications. The system typically employs a central pumping design. The central pumping design involves a single pump design, usually located within a basement or mechanical room to fulfill pumping requirements for the entire building system. An auxiliary pump is typically applied to lessen the likelihood of system downtime if the main pump malfunctions.

Furring-In the Unit

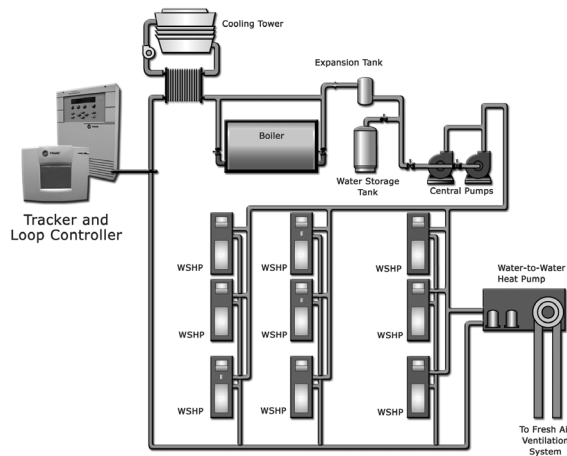

The vertical high-rise water-source heat pump is designed to be a furred-in application. Dry-wall (sheetrock) is attached to furring studs (not unit cabinet) until the entire cabinet, except the front access panel, is enclosed. Access to the unit is made entirely through the front panel which spans approximately one-half of the unit height. The dry-wall enclosure allows the unit to blend in with the decor of the room. If renovations are needed, the drywall portion of the unit can simply be re-papered or repainted with the remainder of the room. With careful design, the high-rise WSHP can be incorporated into a room design, while occupying minimum floor space.

Installation Tips

When installing a high-rise water-source heat pump, there are specific installation requirements that should be taken into consideration. These include:

- Noise control
- Riser location
- Furring-in the unit

Sound Attenuation

The high-rise heat pump is better suited for acoustically sensitive water-source heat pump applications than other water-source products. Compressor and water noise are attenuated by the filter panel, sheet rock and the acoustically lined door. Air noise is silenced through the extended and insulated duct portion at the top of the vertical cabinet.

Figure 3. Installation illustration

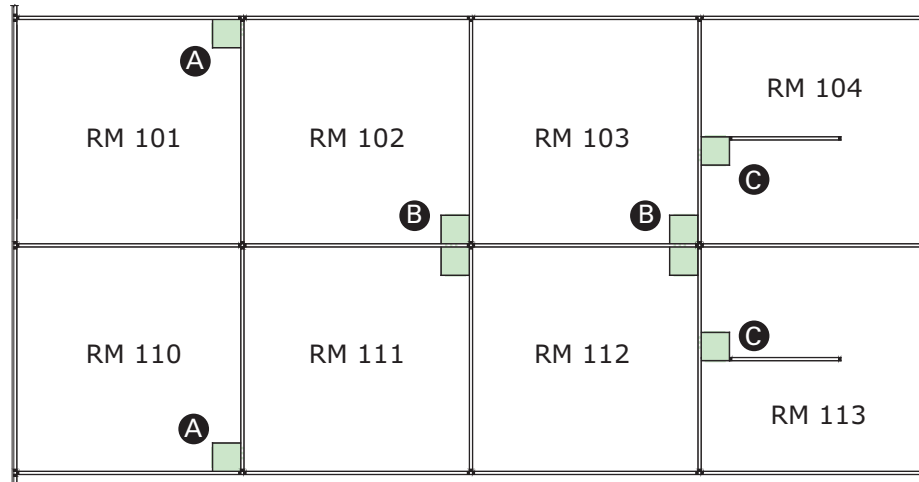

Equipment Installation

The vertical high-rise unit is versatile in design to fit numerous applications. It is typically applied to dorm rooms, hotels and motels where multiple supply air configurations may be required for individual tenant heating and cooling. The equipment requires little space, and is tucked away from sight, and rough handling. The vertical stack design is economical to install, requiring no ductwork for air supply. The riser design may be stacked one on top of another for multi-story applications, or shared between two units (see example B) when architectural design permits. Because the chassis is removable, serviceability to the equipment is enhanced. If service does become a requirement, the chassis is simple to remove from the cabinet, replaced with a back-up chassis, then repaired off-site at a convenient time.

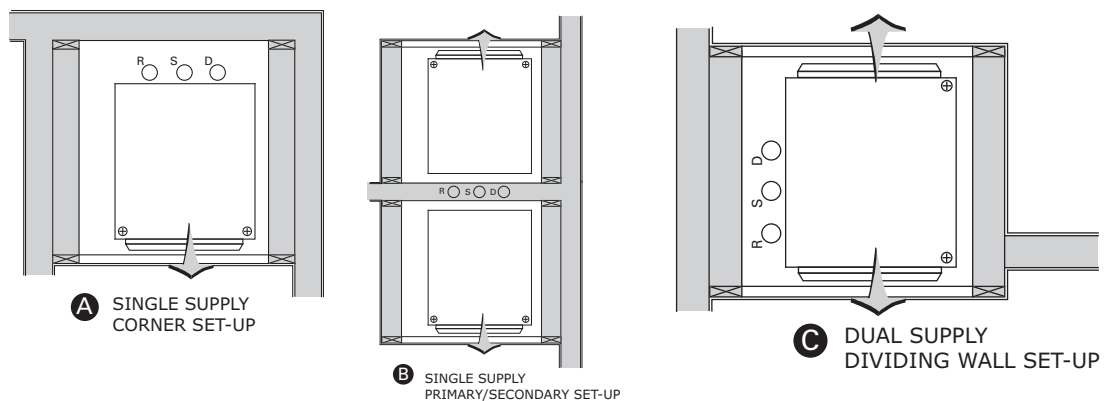

Equipment Risers

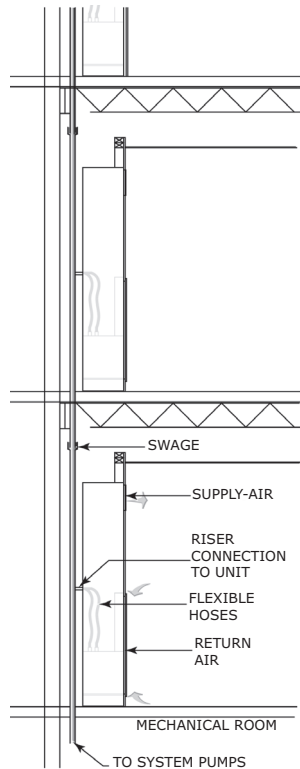

The riser provides an easy way to facilitate the water flow through a multi-story building and the high-rise heat pump. The high-rise heat pump is best applied to a building with identical zones on each floor, and zones that are typically small. An example building might include a hotel, dorm, condominium or assisted living facility. With these types of buildings, the riser column (external to the unit cabinet) can be stacked one on top of the other. The piping installation for the entire HVAC system becomes very simple to install because it is pre-measured, and pre-fabricated at the factory.

Factory risers are available as Type K (design special), L (standard design), and M (standard design). The differences between these types of materials is the wall thickness of the copper. The following table shows the wall thickness for the most common diameters of risers. It is recommended for most jobs to use type L or M copper. Type K risers are generally not necessary for most high-rise heat pump applications.

The riser design contains threaded stubouts to facilitate connection of the supply and return risers to the hose kits. The hose kits are then connected to the water-in/out of the unit's chassis.

Note: *Supply/return/drain risers that are ordered and supplied through the factory may be ordered as insulated.*

Drain risers are generally made of type M copper. If copper drain risers are used, the risers should be insulated since the typical temperatures of condensate may cause the riser to sweat.

Table 1. Riser characteristics

Type K (special design)			
Riser Size (inches)	I.D. (inches)	O.D. (inches)	Copper Wall Thickness (inches)
1	0.995	1.125	0.065
1¼	1.245	1.375	0.065
1½	1.481	1.625	0.072
2	1.959	2.125	0.083
2½	2.435	2.625	0.095
3	2.907	3.125	0.109
Type L (standard)			
1	1.025	1.125	0.05
1¼	1.265	1.375	0.055
1½	1.505	1.625	0.06
2	1.985	2.125	0.07
2½	2.465	2.625	0.08
3	2.945	3.125	0.09
Type M (standard)			
Riser Size (inches)	I.D. (inches)	O.D. (inches)	Copper Wall Thickness (inches)
1	1.055	1.125	0.035
1¼	1.291	1.375	0.042

Table 1. Riser characteristics (continued)

Type M (standard)			
Riser Size (inches)	I.D. (inches)	O.D. (inches)	Copper Wall Thickness (inches)
1½	1.527	1.625	0.049
2	2.009	2.125	0.058
2½	2.495	2.625	0.065
3	2.981	3.125	0.072

Note: Pressure ratings for risers are typically greater than the maximum pressure rating of the coaxial water-to-refrigerant heat exchangers. This is true with exception of Type M copper in a 3" diameter. The maximum pressure rating for Type M, 3" diameter copper is 380 psig. All other diameters for Type M copper, and all 1" through 3" Type L copper are greater than the 400 psig rating on the coaxial water-to-refrigerant heat exchanger.

Riser Sizing

The proper selection of riser diameter is critical when designing a cost effective job. If the riser diameter is too small, the flow of water to the heat pump may be restricted, making the pumping power requirement excessive. On the other hand, if the riser diameter is too large, the cost of the equipment may become unnecessarily high.

To determine the riser size, calculate the flow at a particular riser. Riser columns will begin with large diameters at the bottom of the column and decrease diameter as the water travels up toward the top floor. The GPM at the first floor is determined by totaling the GPM of all the units on the riser column. The GPM for the second floor is then determined by taking the total GPM and subtracting the flow from the first floor.

The proper size of the riser is determined by calculating the velocity of the water in the riser. The maximum water velocity that a riser should experience is about 6 or 7 feet/second. The maximum riser flow rate table can be used as a quick reference chart for determining the maximum GPM allowed for a given riser size. Riser flow diagram can be found in the [2009 ASHRAE Fundamentals Handbook](#) and may be used to calculate the precise water velocity for a given riser diameter and flow.

Table 2. Maximum riser flow rate

Riser Size (inches)	Max. GPM	Water Velocity (ft./sec.)	Head Loss (ft.100 ft.)
1	16	6.2	15.6
1¼	24	6.1	11.8
1½	34	6.1	9.38
2	58	6.0	6.6
2½	90	6.0	5.1
3	130	6.1	4.2

Note: This table is for general design calculation reference. It is not intended to take the place of an engineered piping design.

Riser Size Example

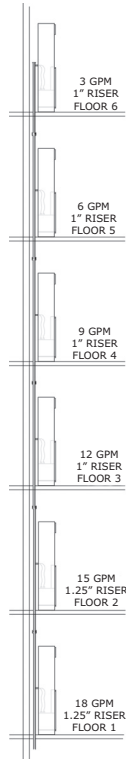

Assume a six story building is served by a high-rise water-source heat pump. When referencing the catalog, determine each high-rise heat pump uses 3 gallons per minute to meet the required capacity of the 1 ton unit. What is the minimum riser diameter that can be used on each floor?

With this arrangement, determine the volume of water used at each floor is 3 gpm. The top floor riser therefore only needs to be sized for 3 gpm. Referring to the maximum riser flow rate table, a 1 inch type M riser can handle up to 16 gpm, therefore the riser size is determined to be 1-inch.

The first floor will see 18 gpm through the riser. Since 18 gpm will result in more than 6 ft./second in a 1" riser, it would be advisable to move to a 1.25" riser.

Piping Layout of the Riser

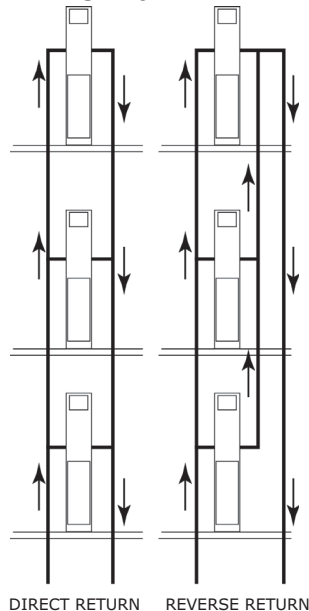

Two methods may be used when piping a riser column. These include direct return or reverse return.

Advantages may be seen in both types of piping methods. For a direct return installation, the riser system is straightforward leaving little confusion about properly sized risers. This provides a more cost effective advantage during the installation process.

The disadvantages of this system is the pressure drop. The total pressure drop on the unit for the sixth floor is much greater than the total pressure drop on the unit for the first floor. This means that the riser column will require balancing from floor-to-floor during installation.

Piping advantages for the reverse return system include the ability to design the riser column so that the total system pressure drop through each unit is equalized. The overall pressure drop is also lower, allowing some energy savings potential. This piping method however does not eliminate the need for proper balancing at each unit.

The disadvantage of this system relates to cost and complexity. The reverse return method typically costs more because of the additional pipe required for each riser column.

Central Plant Control

Proper central plant control is critical to the operation of a water-source heat pump system. Loss of water flow or loop temperatures outside of the recommended range will severely impact the operation of the equipment. The following should be followed as minimum operational recommendation for the central plant:

- Heat rejector control (i.e. closed circuit cooling tower, or geothermal loop)
- Heat adder (i.e. boiler or geothermal loop)
- Circulating pumps
- Sensing elements

Heat Rejection through a Closed Circuit Cooling Tower

Cooling towers serve to reject heat from the condenser water loop to the atmosphere. Two types of cooling towers are used with water-source heat pump systems: open or closed-circuit. The towers themselves are different, but when an open tower is used in conjunction with a water-to-water heat exchanger, the control of the two tower types is essentially the same.

Control for the closed-circuit cooling towers may be made with a controller.

When the loop supply temperature is 4°F below the loop supply high setpoint, the first stage of cooling is initiated by opening the closure dampers on the cooling tower.

At 2° F below the setpoint the next stage of cooling is initiated which is the starting of the tower's circulating pump. If the amount of heat rejected by the first two stages is not enough, the loop temperature will continue to rise. When the temperature reaches the loop supply high setpoint, the next stage of cooling is initiated. This is the first stage of cooling tower fans.

The differential between the stages now become 3°F and the temperature must remain above the differential for three minutes. Up to three individual fan stages may be sequenced or the second stage of fan can be the high speed of a multi-speed motor.

Boiler Operation

The controller will operate a boiler and the mixing valve respectively. Boiler control is traditionally controlled by a separate boiler controller, provided by the boiler manufacturer. The boiler mixing valve will control the mixture of the boiler water into the main loop to achieve the desired loop supply water.

When the loop temperature falls below the low loop-supply setpoint, the controller enables the boiler. The ideal arrangement is for the boiler to have its own bypass loop so the boiler pump can circulate water through the heat exchanger. The boiler will maintain the temperature of the water to the desired setting in the packaged boiler control.

The three-way mixing valve is controlled by the controller to add heat to the main loop by mixing in water from the boiler loop. A proportional-integral-derivative algorithm controls the valve. The boiler is not disabled until the main loop temperature is 5°F greater than the low loop supply setpoint for more than 5 minutes.

The controller will also monitor the boiler loop temperature and provide an alarm if the temperature is below the boiler loop low limit after 30 minutes of run time. The controller will provide an alarm if the boiler loop temperature exceeds the boiler loop high limit after 30 minutes continually.

Facilities Management

Water-source heat pump systems are naturally decentralized; thus they inherently provide individual zone control. Typical installations use mechanical thermostats to provide localized control. Central plant control is typically handled by a control panel located in the main mechanical room. Minimal coordination is usually required between the central plant and the individual water-source heat pumps for successful operation of the system. A direct digital control system is recommended to help support coordination efforts between the central plant and the individual water-source heat pumps. This enhanced coordination can result in reductions in operating cost of the entire system. The following items are typical of the additional coordination: night setback and setup, after hour usage for tracking and billing, pump cycling for occupied/



Application Considerations

unoccupied control, zone scheduling, maintenance reporting for monitoring unit fault conditions, trend logging of the system water temperatures, monitoring of system levels for items such as water flow, temperature, faults, heat rejector status, heat adder status and circulating pump status.



Selection Procedures

Model Number

Two model number designators have been defined for the cabinet configuration, and the chassis configuration. Both model numbers require input for the order to be complete and built to specification.

Typically the vertical stack equipment ships in two sections.

- The cabinet and riser section ship first to allow the contractor to furr-in the equipment during sheetrock installation
- The chassis (refrigeration/water) section ship approximately two to four weeks later eliminating storage requirements of the chassis and possible damage at the job site while waiting for installation.

For this reason, there are two model number designators specific to the unit chassis, and the cabinet for the equipment.



Model Number Descriptions

Vertical High-Rise Cabinet WSHP

Digits 1, 2, 3 — Unit Configuration

GET = High Efficiency Vertical High Rise Heat Pump

Digit 4 — Development Sequence

E = R-410A

Digits 5, 6, 7 — Nominal Size (Tons)

009 = 0.75 Tons
012 = 1 Tons
015 = 1.25 Tons
018 = 1.5 Tons
024 = 2 Tons
036 = 3 Tons

Digit 8 — Voltage (Volts/Hz/Phase)

1 = 208/60/1
2 = 230/60/1
7 = 265/60/1

Digit 9 — Heat Exchanger

1 = Copper Water Coil
2 = Cupro-Nickel Water Coil
3 = Copper Water Coil with Isolation Valve and Low Flow Control
4 = Cupro-Nickel Water Coil with Isolation Valve and Low Flow Control
5 = Copper Water Coil with Isolation Valve and High Flow Control
6 = Cupro-Nickel Water Coil with Isolation Valve and High Flow Control

Digit 10 — Current Design Sequence

Digit 11 — Refrigeration Circuit

0 = Heating and Cooling Circuit

Digit 12 — Blower Configuration

1 = Free Discharge (Factory Wire Low Speed) - PSC motor
2 = Ducted (Factory Wire Hi Speed) - PSC motor
3 = Free Discharge with 1-inch Flange - PSC motor
4 = Free Discharge with 3-inch Flange - PSC motor
5 = ECM without Flange
6 = ECM with 1-inch Flange
7 = ECM with 3-inch flange
8 = Chassis only/No Motor (ECM Control)
9 = Chassis only/No Motor (PSC Control)

Digit 13 — Freeze Protection

A = 20° Freezestat (For Glycol Loop)
B = 35° Freezestat (For Water Loop)

Digit 14 — Open Digit

0 = Open
S = Special

Digit 15 — Supply Air Arrangement

0 = Field Cut Supply Air Arrangement
1 = Back and Front Supply Air Arrangement
2 = Back and Left Supply Air Arrangement
3 = Back and Right Supply Air Arrangement
4 = Front and Left Supply Air Arrangement
5 = Front and Right Supply Air Arrangement
6 = Left and Right Supply Air Arrangement
7 = Back, Front and Right Supply Air Arrangement
8 = Back, Front and Left Supply Air Arrangement
9 = Front, Right and Left Supply Air Arrangement
B = Back Supply Air Arrangement
L = Left Supply Air Arrangement
R = Right Supply Air Arrangement
T = Top Supply Air Arrangement
F = Front Supply Air Arrangement

Digit 16 — Return Air Arrangement

0 = No Door
1 = Hinged Return Air Door
3 = Hinged Return Air Door, Tamper Resistant (HEX)
4 = Hinged Return Air Door, with Key Lock

Digit 17 — Control Types

D = Deluxe 24 V Controls
H = Symbio™ 400-B/UC400-B
J = Symbio 400-B/UC400-B with Air-Fi® Wireless Communications

Digit 18 — Thermostat Sensor Location

0 = Wall Mounted Location

Digit 19 — Fault Sensors

0 = No Fault Sensors
1 = Condensate Overflow Sensor
2 = Filter Maintenance Timer
3 = Condensate Overflow and Filter Maintenance Timer

Digit 20 — Temperature Sensor

0 = No Additional Temperature Sensors
1 = Entering Water Sensor

Digit 21, 22 — Open Digits

Digit 23 — Unit Mounted Disconnect

0 = No Unit Mounted Switch
C = ON/OFF Switch
D = ON/OFF Switch with Fuses

Digit 24 — Filter Type

1 = 1-inch Throwaway Filter

Digit 25 — Acoustic Arrangement

0 = Enhanced Sound Attenuation
1 = Deluxe Sound Attenuation

Digit 26 — Factory Configuration

3 = R-410A Cabinet Only with Standard Base
4 = R-410A Cabinet Only with 6-inch Extended Base

Digit 27 — Paint Color

9 = Light White Finish

Digit 28 — Outside Air Option

0 = No Outside Air

Digit 29 — Piping Arrangement

B = Back Riser Location
L = Left Hand Riser Location
R = Right Hand Riser Location

Digit 30 — Riser Type

0 = No Riser
L = Type L Riser
M = Type M Riser

Digit 31 — Supply Riser

0 = No Riser
B = 1-inch Riser with Insulation
C = 1.25-inch Riser with Insulation
D = 1.5-inch Riser with Insulation
E = 2-inch Riser with Insulation
F = 2.5-inch Riser with Insulation
G = 3-inch Riser with Insulation
2 = 1-inch Riser
3 = 1.25-inch Riser
4 = 1.5-inch Riser
5 = 2-inch Riser
6 = 2.5-inch Riser
7 = 3-inch Riser

Digit 32 — Return Riser

0 = No Riser
B = 1-inch Riser with Insulation
C = 1.25-inch Riser with Insulation
D = 1.5-inch Riser with Insulation
E = 2-inch Riser with Insulation
F = 2.5-inch Riser with Insulation
G = 3-inch Riser with Insulation
2 = 1-inch Riser
3 = 1.25-inch Riser
4 = 1.5-inch Riser
5 = 2-inch Riser
6 = 2.5-inch Riser
7 = 3-inch Riser

Digit 33 — Condensate Riser

0 = No Riser
B = 1-inch Riser with Insulation
C = 1.25-inch Riser with Insulation
D = 1.5-inch Riser with Insulation
E = 2-inch Riser with Insulation
F = 2.5-inch Riser with Insulation
G = 3-inch Riser with Insulation
2 = 1-inch Riser
3 = 1.25-inch Riser

- 4 = 1.5-inch Riser
- 5 = 2-inch Riser
- 6 = 2.5-inch Riser
- 7 = 3-inch Riser

Digit 34, 35, 36 — Riser Length

- 000 = No Riser
- 096 = 96-inch Riser Length
- 097 = 97-inch Riser Length
- 098 = 98-inch Riser Length
- 099 = 99-inch Riser Length
- 100 = 100-inch Riser Length
- 101 = 101-inch Riser Length
- 102 = 102-inch Riser Length
- 103 = 103-inch Riser Length
- 104 = 104-inch Riser Length
- 105 = 105-inch Riser Length
- 106 = 106-inch Riser Length
- 107 = 107-inch Riser Length
- 108 = 108-inch Riser Length
- 109 = 109-inch Riser Length
- 110 = 110-inch Riser Length
- 111 = 111-inch Riser Length
- 112 = 112-inch Riser Length
- 113 = 113-inch Riser Length
- 114 = 114-inch Riser Length
- 115 = 115-inch Riser Length
- 116 = 116-inch Riser Length
- 117 = 117-inch Riser Length
- 118 = 118-inch Riser Length
- 119 = 119-inch Riser Length
- 120 = 120-inch Riser Length

Vertical High-Rise Chassis WSHP

Digits 1, 2, 3 — Unit Configuration

GET = High Efficiency Vertical High Rise Heat Pump

Digit 4 — Development Sequence

E = R-410A

Digits 5, 6, 7 — Nominal Size (Tons)

- 009 = 0.75 Tons
- 012 = 1 Tons
- 015 = 1.25 Tons
- 018 = 1.5 Tons
- 024 = 2 Tons
- 036 = 3 Tons

Digit 8 — Voltage (Volts/Hz/Phase)

- 1 = 208/60/1
- 2 = 230/60/1
- 7 = 265/60/1

Digit 9 — Heat Exchanger

- 1 = Copper Water Coil
- 2 = Cupro-Nickel Water Coil
- 3 = Copper Water Coil with Isolation Valve and Low Flow Control
- 4 = Cupro-Nickel Water Coil with Isolation Valve and Low Flow Control
- 5 = Copper Water Coil with Isolation Valve and High Flow Control
- 6 = Cupro-Nickel Water Coil with Isolation Valve and High Flow Control

Digit 10 — Current Design Sequence

Digit 11 — Refrigeration Circuit

- 0 = Heating and Cooling Circuit

Digit 12 — Blower Configuration

- 1 = Free Discharge (Factory Wire Low Speed) - PSC motor
- 2 = Ducted (Factory Wire Hi Speed) - PSC motor
- 3 = Free Discharge with 1-inch Flange - PSC motor
- 4 = Free Discharge with 3-inch Flange - PSC motor
- 5 = ECM without Flange
- 6 = ECM with 1-inch Flange
- 7 = ECM with 3-inch Flange
- 8 = Chassis only/No Motor (ECM Control)
- 9 = Chassis only/No Motor (PSC Control)

Digit 13 — Freeze Protection¹

- A = 20° Freezestat (For Glycol Loop)
- B = 35° Freezestat (For Water Loop)

Digit 14 — Open Digit

- 0 = Open

Digit 15 — Supply Air Arrangement

- 0 = Field Cut Supply Air Arrangement
- 1 = Back and Front Supply Air Arrangement
- 2 = Back and Left Supply Air Arrangement
- 3 = Back and Right Supply Air Arrangement
- 4 = Front and Left Supply Air Arrangement
- 5 = Front and Right Supply Air Arrangement
- 6 = Left and Right Supply Air Arrangement
- 7 = Back, Front and Right Supply Air Arrangement
- 8 = Back, Front and Left Supply Air Arrangement
- 9 = Front, Right and Left Supply Air Arrangement
- B = Back Supply Air Arrangement
- L = Left Supply Air Arrangement
- R = Right Supply Air Arrangement
- T = Top Supply Air Arrangement
- F = Front Supply Air Arrangement

Digit 16 — Return Air Arrangement

- 0 = No Door (Chassis Only)
- 1 = Flush with Wall, Hinged Return AirDoor
- 3 = Hinged Return Air Door, Tamper Resistant (HEX)
- 4 = Hinged Return Air Door, with Key Lock

Digit 17 — Control Types

- 0 = Basic Controls for WPRD Retrofit Chassis
- D = Deluxe 24 V Controls

- H = Symbio 400-B/UC400-B
- J = Symbio 400-B/UC400-B with Air-Fi Wireless Communications

Digit 18 — Thermostat Sensor Location

- 0 = Wall Mounted Location

Digit 19 — Fault Sensors

- 0 = No Fault Sensors
- 1 = Condensate Overflow Sensor
- 2 = Filter Maintenance Timer
- 3 = Condensate Overflow and Filter Maintenance Timer

Digit 20 — Temperature Sensor

- 0 = No Additional Temperature Sensors
- 1 = Entering Water Sensor

Digit 21, 22 — Open Digits

Digit 23 — Unit Mounted Disconnect

- 0 = No Unit Mounted Switch
- C = ON/OFF Switch
- D = ON/OFF Switch with Fuses

Digit 24 — Filter Type

- 1 = 1-inch Throwaway Filter

Digit 25 — Acoustic Arrangement

- 0 = Enhanced Sound Attenuation
- 1 = Deluxe Sound Attenuation

Digit 26 — Factory Configuration

- 2 = R-410A Chassis
- R = WPRD Retrofit Chassis

Digit 27 — Paint Color

- 9 = Light White Finish

Digit 28 — Outside Air Option

- 0 = No Outside Air

Digit 29 — Piping Arrangement

- B = Back Riser Location
- L = Left Hand Riser Location
- R = Right Hand Riser Location

Digit 30 — Riser Type

- 0 = No Riser (Chassis Only)

Digit 31 — Supply Riser

- 0 = No Riser (Chassis Only)

Digit 32 — Return Riser

- 0 = No Riser (Chassis Only)

Digit 33 — Condensate Riser

- 0 = No Riser (Chassis Only)

Digit 34, 35, 36 — Riser Length

- 000 = No Riser (Chassis Only)

¹ 20°F Freezestat is typically used in a geothermal application. 35°F Freezestat is typically used in a boiler/tower application.



General Data

Table 3. General Data

Model Number	009	012	015	018	024	036	
Compressor Type	Rotary	Rotary	Rotary	Rotary	Scroll	Scroll	
Cabinet Size ^(a)	Depth (inches)	16.00	16.00	18.00	18.00	24.00	24.00
	Height (inches) with Standard Base	88.00	88.00	88.00	88.00	88.00	88.00
	Height (inches) with 6-inch Extended Base	94.00	94.00	94.00	94.00	94.00	94.00
	Width (inches)	16.00	16.00	20.00	20.00	24.00	24.00
Approximate weight cabinet	with Pallet (lb)	135.00	135.00	175.00	175.00	225.00	225.00
Approximate weight cabinet	without Pallet (lb)	115.00	115.00	15.00	15.00	195.00	195.00
Approximate weight chassis	with Pallet (lb)	88.00	107.00	112.00	117.00	174.00	190.00
Approximate weight chassis	without Pallet (lb)	78.00	97.00	102.00	107.00	164.00	180.00
Air-to-Refrigerant Coil	Face Area (sq. ft.)	1.35	1.35	2.11	2.11	2.88	2.88
	Face Area (sq. cm)	1254.00	1254.00	1959.00	1959.00	2676.00	2676.00
	Rows	2.00	4.00	4.00	4.00	3.00	4.00
	Fins Per Inch	14.00	14.00	14.00	14.00	14.00	14.00
	Fins Per cm.	5.50	5.50	5.50	5.50	5.50	5.50
Nominal 1 in. Filter Size	Inches	14 x 20	14 x 20	18 x 25	18 x 25	20 x 30	20 x 30
Water In/Out size	NPTI (inches)	½	½	½	½	¾	¾
Condensate	Plastic Hose ID (inches)	¾	¾	¾	¾	¾	¾
Riser Connection	NPTE (inches)	½	½	½	½	¾	¾
PSC Ducted Discharge	Blower	90-6TDD	90-6TDD	90-6RDD	100-6TDD	100-6TDD	120-8TDD11
	Motor HP	0.05	0.125	0.125	0.20	0.33	0.50
PSC Free Discharge	Blower	90-6TDD	90-6TDD	90-6RDD	100-6TDD	100-6TDD	120-8TDD11
	Motor HP	0.05	0.125	0.125	0.125	0.33	0.5
ECM	Blower	90-6TDD	90-6TDD	100-6TDD	100-6TDD	120-8TDD11	120-8TDD11
	Motor HP	0.33	0.33	0.50	0.50	0.50	0.75
Water-to-Refrigerant Coil	Refrig. Side (PSIG)	650.00	650.00	650.00	650.00	650.00	650.00
	Water Side (PSIG)	400.00	400.00	400.00	400.00	400.00	400.00
	Internal Volume (gal)	0.081	0.081	0.228	0.228	0.271	0.368

(a) Cabinets with top supply air option are 8-inch shorter in height.



Performance Data

Table 4. ANSI/AHRI/ASHRAE/ISO13256-1 WLHP, GWHP, and GLHP performance - 0.75 to 3 tons^(a)

Model	Rated GPM	Rated CFM ^(b)	Water Loop Heat Pump				Ground Water Heat Pump				Ground Loop Heat Pump			
			Cooling 86°F		Heating 68°F		Cooling 59°F		Heating 50°F		Full Cool 77°F		Full Heat 32°F	
			Capacity Btuh	EER	Capacity Btuh	COP	Capacity Btuh	EER	Capacity Btuh	COP	Capacity Btuh	EER	Capacity Btuh	COP
PSC Motor														
GET009	2.1	340	8,200	12.2	10,800	4.5	9,700	18.0	8,700	3.7	8,800	14.2	6,600	3.2
GET012	2.8	380	11,900	12.8	14,100	4.5	13,100	18.0	11,800	3.9	12,300	14.4	9,000	3.2
GET015	3.5	540	14,700	13.0	17,700	4.5	16,600	19.1	13,700	3.7	15,400	14.1	11,800	3.2
GET018	4.2	650	18,100	13.0	22,900	4.5	19,500	18.0	17,900	3.7	18,700	14.1	14,800	3.3
GET024	5.6	820	23,300	13.0	26,600	4.3	25,600	18.1	23,600	3.9	24,300	14.5	18,700	3.2
GET036	8.4	1170	33,700	13.0	41,300	4.3	37,900	18.2	34,400	3.7	35,100	14.2	27,300	3.2
ECM														
GET009	2.1	340	8,300	13.2	10,500	4.5	9,600	20.1	8,500	3.8	8,700	15.4	6,500	3.2
GET012	2.8	380	12,000	13.5	13,700	4.8	13,200	21.0	11,600	3.9	12,600	15.7	8,700	3.2
GET015	3.5	540	14,900	14.3	17,300	4.8	16,700	22.3	13,300	4.0	15,600	16.1	11,300	3.4
GET018	4.2	650	18,500	13.9	22,300	4.6	19,600	21.2	17,300	3.9	18,800	16.2	14,200	3.4
GET024	5.6	820	23,500	15.7	25,300	4.6	25,100	22.1	22,400	4.2	24,500	17.7	17,800	3.5
GET036	8.4	1170	34,200	14.8	39,100	4.5	37,800	23.1	32,600	4.0	35,100	17.4	25,700	3.5

(a) Rated in accordance ANSI/AHRI/ASHRAE/ISO13256-1. Certified conditions are 80.6°F DB/66.2°F WB EAT in cooling and 68°F DB/59°F WB EAT in heating.
 (b) Rated Airflow is with return air door (RAD) with filter.

Table 5. Cooling capacities 0.75 tons (net) - GET009

EWT	GPM	Total Mbtuh	Sen Mbtuh	SHR	Heat of Rej (Mbtuh)	Comp Pwr (kW)	LWT	Feet Head
45	1.1	10.3	8.0	0.77	11.7	0.41	65.7	2.1
45	1.5	10.4	8.0	0.77	11.8	0.40	60.7	3.4
45	1.8	10.5	8.0	0.76	11.9	0.39	58.2	4.7
45	2.1	10.6	8.1	0.76	12.0	0.39	56.4	6.2
45	2.3	10.8	8.1	0.75	12.1	0.39	55.7	6.9
45	2.4	10.8	8.1	0.75	12.1	0.39	55.1	7.8
45	2.6	10.8	8.1	0.75	12.2	0.39	54.3	9.1
55	1.1	9.8	7.8	0.79	11.3	0.44	75.1	2.0
55	1.5	10.0	7.9	0.79	11.4	0.42	70.2	3.3
55	1.8	10.1	7.9	0.78	11.5	0.42	67.8	4.5
55	2.1	10.2	7.9	0.78	11.6	0.41	66.0	5.9
55	2.3	10.2	7.9	0.78	11.6	0.41	65.3	6.7
55	2.4	10.2	7.9	0.78	11.6	0.41	64.7	7.5
55	2.6	10.3	8.0	0.77	11.7	0.41	63.9	8.7
68	1.1	9.4	7.7	0.82	11.1	0.49	87.7	1.9
68	1.5	9.5	7.7	0.81	11.1	0.47	82.8	3.1
68	1.8	9.6	7.7	0.81	11.1	0.46	80.4	4.3
68	2.1	9.6	7.7	0.80	11.2	0.46	78.6	5.6
68	2.3	9.6	7.8	0.80	11.2	0.45	77.9	6.4
68	2.4	9.7	7.8	0.80	11.2	0.45	77.3	7.1
68	2.6	9.7	7.8	0.80	11.2	0.45	76.5	8.3
75	1.1	9.2	7.6	0.83	11.0	0.53	94.5	1.8



Performance Data

Table 5. Cooling capacities 0.75 tons (net) - GET009 (continued)

EWT	GPM	Total Mbtuh	Sen Mbtuh	SHR	Heat of Rej (Mbtuh)	Comp Pwr (kW)	LWT	Feet Head
75	1.5	9.3	7.6	0.82	11.0	0.51	89.7	3.1
75	1.8	9.3	7.7	0.82	11.0	0.49	87.2	4.2
75	2.1	9.4	7.7	0.82	11.0	0.49	85.5	5.5
75	2.3	9.4	7.7	0.82	11.0	0.48	84.8	6.2
75	2.4	9.4	7.7	0.82	11.1	0.48	84.2	7.0
75	2.6	9.4	7.7	0.82	11.1	0.48	83.4	8.2
77	1.1	9.1	7.6	0.83	11.0	0.54	96.5	1.8
77	1.5	9.2	7.6	0.83	11.0	0.52	91.6	3.0
77	1.8	9.3	7.6	0.82	11.0	0.51	89.2	4.2
77	2.1	9.3	7.7	0.82	11.0	0.50	87.5	5.5
77	2.3	9.3	7.7	0.82	11.0	0.49	86.8	6.2
77	2.4	9.3	7.7	0.82	11.0	0.49	86.2	6.9
77	2.6	9.3	7.7	0.82	11.0	0.49	85.4	8.1
86	1.1	8.9	7.5	0.85	10.9	0.60	105.4	1.8
86	1.5	8.9	7.5	0.84	10.9	0.57	100.5	3.0
86	1.8	9.0	7.5	0.84	10.9	0.56	98.1	4.1
86	2.1	9.0	7.6	0.84	10.9	0.55	96.4	5.3
86	2.3	9.0	7.6	0.84	10.9	0.55	95.7	6.0
86	2.4	9.0	7.6	0.84	10.9	0.54	95.0	6.7
86	2.6	9.0	7.6	0.84	10.9	0.54	94.3	7.9
95	1.1	8.6	7.4	0.86	10.9	0.67	114.4	1.7
95	1.5	8.7	7.5	0.86	10.8	0.64	109.5	2.8
95	1.8	8.7	7.5	0.86	10.8	0.62	107.0	3.8
95	2.1	8.7	7.5	0.86	10.8	0.61	105.3	5.1
95	2.3	8.7	7.5	0.86	10.8	0.61	104.6	5.7
95	2.4	8.7	7.5	0.86	10.8	0.61	104.0	6.4
95	2.6	8.7	7.5	0.86	10.8	0.60	103.2	7.5
105	1.1	8.4	7.4	0.88	10.9	0.76	124.4	1.6
105	1.5	8.4	7.4	0.88	10.8	0.72	119.5	2.7
105	1.8	8.4	7.4	0.88	10.8	0.71	117.0	3.7
105	2.1	8.4	7.4	0.88	10.8	0.70	115.2	4.9
105	2.3	8.4	7.4	0.88	10.8	0.69	114.6	5.5
105	2.4	8.4	7.4	0.88	10.7	0.69	113.9	6.2
105	2.6	8.4	7.4	0.88	10.7	0.69	113.2	7.3
115	1.1	8.1	7.3	0.90	11.0	0.86	134.6	1.6
115	1.5	8.1	7.3	0.90	10.9	0.83	129.6	2.6
115	1.8	8.1	7.3	0.90	10.9	0.81	127.1	3.6
115	2.1	8.1	7.3	0.90	10.8	0.80	125.3	4.8
115	2.3	8.1	7.3	0.90	10.8	0.80	124.6	5.4
115	2.4	8.1	7.3	0.90	10.8	0.79	124.0	6.1
115	2.6	8.1	7.3	0.90	10.8	0.79	123.2	7.1
120	1.1	8.0	7.3	0.91	11.2	0.94	139.9	1.6
120	1.5	8.0	7.2	0.91	11.0	0.90	134.7	2.6
120	1.8	8.0	7.2	0.91	11.0	0.88	132.2	3.6
120	2.1	8.0	7.2	0.91	10.9	0.87	130.4	4.7

Table 5. Cooling capacities 0.75 tons (net) - GET009 (continued)

EWT	GPM	Total Mbtuh	Sen Mbtuh	SHR	Heat of Rej (Mbtuh)	Comp Pwr (kW)	LWT	Feet Head
120	2.3	8.0	7.2	0.91	10.9	0.86	129.7	5.3
120	2.4	7.9	7.2	0.91	10.9	0.86	129.0	6.0
120	2.6	7.9	7.2	0.91	10.8	0.85	128.3	7.0

Notes: Cooling performance data is tabulated at 80.6°F DB/66.2°F WB entering air at ANSI/AHRI/ASHRAE/ISO13256-1 rated CFM. For ANSI/AHRI/ASHRAE/ISO13256-1 certified ratings, refer to the ANSI/AHRI/ASHRAE/ISO13256-1 WLHP, GWHP and GLHP performance table. See performance correction tables to correct performance at conditions other than those tabulated. Data shown is for unit performance only. Interpolation is permissible, extrapolation is not. Rated GPM 2.1; Minimum cfm 292; Rated cfm 340; Maximum cfm 408.

Table 6. Heating capacities 0.75 tons (net) - GET009

EWT	GPM	Total Mbtuh	Heat of Absorb (Mbtuh)	Compr Power (kW)	LWT	Feet Head
25	1.1	6.0	4.2	0.52	17.5	2.7
25	1.5	6.2	4.4	0.52	19.1	4.5
25	1.8	6.3	4.5	0.53	20.0	6.2
25	2.1	6.4	4.6	0.53	20.6	8.1
25	2.3	6.4	4.6	0.53	20.9	9.1
25	2.4	6.5	4.7	0.53	21.1	10.2
25	2.6	6.5	4.7	0.53	21.4	11.9
32	1.1	6.7	4.8	0.53	23.4	2.7
32	1.5	6.9	5.1	0.54	25.3	4.4
32	1.8	7.0	5.2	0.54	26.2	6.0
32	2.1	7.1	5.3	0.54	27.0	7.9
32	2.3	7.2	5.3	0.54	27.3	8.9
32	2.4	7.2	5.3	0.54	27.6	9.9
32	2.6	7.3	5.4	0.54	27.9	11.6
45	1.1	8.1	6.2	0.56	34.0	2.1
45	1.5	8.4	6.5	0.57	36.4	3.4
45	1.8	8.6	6.6	0.57	37.6	4.7
45	2.1	8.7	6.7	0.57	38.6	6.2
45	2.3	8.7	6.8	0.57	39.0	6.9
45	2.4	8.8	6.8	0.57	39.3	7.8
45	2.6	8.8	6.9	0.57	39.8	9.1
55	1.1	9.2	7.2	0.58	42.2	2.0
55	1.5	9.5	7.5	0.58	45.0	3.3
55	1.8	9.7	7.7	0.59	46.4	4.5
55	2.1	9.9	7.9	0.59	47.5	5.9
55	2.3	9.9	7.9	0.59	48.0	6.7
55	2.4	10.0	8.0	0.59	48.4	7.5
55	2.6	10.1	8.0	0.59	48.9	8.7
68	1.1	10.6	8.6	0.60	52.8	1.9
68	1.5	11.1	9.0	0.61	56.0	3.1
68	1.8	11.3	9.2	0.61	57.8	4.3
68	2.1	11.5	9.4	0.61	59.1	5.6
68	2.3	11.5	9.4	0.61	59.6	6.4
68	2.4	11.6	9.5	0.61	60.1	7.1
68	2.6	11.7	9.6	0.61	60.7	8.3



Performance Data

Table 6. Heating capacities 0.75 tons (net) - GET009 (continued)

EWT	GPM	Total Mbtuh	Heat of Absorb (Mbtuh)	Compr Power (kW)	LWT	Feet Head
75	1.1	11.4	9.3	0.61	58.5	1.8
75	1.5	11.9	9.8	0.62	62.0	3.1
75	1.8	12.2	10.0	0.62	63.9	4.2
75	2.1	12.4	10.2	0.63	65.3	5.5
75	2.3	12.5	10.3	0.63	65.8	6.2
75	2.4	12.5	10.4	0.63	66.4	7.0
75	2.6	12.6	10.5	0.63	67.0	8.2
77	1.1	11.6	9.5	0.62	60.1	1.8
77	1.5	12.1	10.0	0.62	63.7	3.0
77	1.8	12.4	10.3	0.63	65.6	4.2
77	2.1	12.6	10.5	0.63	67.0	5.5
77	2.3	12.7	10.5	0.63	67.6	6.2
77	2.4	12.8	10.6	0.63	68.2	6.9
77	2.6	12.9	10.7	0.63	68.9	8.1
86	1.1	12.7	10.5	0.63	67.3	1.8
86	1.5	13.3	11.1	0.64	71.3	3.0
86	1.8	13.5	11.3	0.65	73.4	4.1
86	2.1	13.8	11.6	0.65	75.0	5.3
86	2.3	13.8	11.6	0.65	75.7	6.0
86	2.4	14.0	11.7	0.66	76.2	6.7
86	2.6	14.0	11.8	0.65	77.0	7.9

Notes: Heating performance data is tabulated at 68°F DB entering air at ANSI/AHRI/ASHRAE/ISO13256-1 rated cfm. For ANSI/AHRI/ASHRAE/ISO13256-1 certified ratings, refer to the ANSI/AHRI/ASHRAE/ISO13256-1 WLHP, GWHP and GLHP performance table. See performance correction tables to correct performance at conditions other than those tabulated. Data shown is for unit performance only. Interpolation is permissible, extrapolation is not. Rated GPM 2.1; Minimum cfm 272; Rated cfm 340; Maximum cfm 408.

Table 7. Cooling capacities 1 tons (net) - GET012

EWT	GPM	Total Mbtuh	Sen Mbtuh	SHR	Heat of Rej (Mbtuh)	Comp Pwr (kW)	LWT	Feet Head
45	1.5	13.1	10.3	0.78	14.7	0.45	64.6	4.9
45	2.0	13.2	10.3	0.78	14.7	0.43	59.7	8.1
45	2.4	13.2	10.3	0.78	14.7	0.42	57.2	11.2
45	2.8	13.3	10.3	0.78	14.7	0.41	55.5	14.6
45	3.0	13.3	10.3	0.78	14.7	0.41	54.8	16.5
45	3.2	13.3	10.3	0.78	14.7	0.41	54.2	18.4
45	3.5	13.3	10.3	0.78	14.7	0.41	53.4	21.5
55	1.5	13.0	10.2	0.79	14.8	0.52	74.7	4.7
55	2.0	13.1	10.2	0.78	14.7	0.49	69.7	7.8
55	2.4	13.1	10.2	0.78	14.7	0.48	67.3	10.7
55	2.8	13.1	10.2	0.78	14.7	0.47	65.5	14.1
55	3.0	13.1	10.2	0.78	14.7	0.46	64.8	15.9
55	3.2	13.1	10.3	0.78	14.7	0.46	64.2	17.8
55	3.5	13.1	10.3	0.78	14.7	0.46	63.4	20.7
68	1.5	12.7	10.1	0.79	14.8	0.62	87.7	4.5
68	2.0	12.8	10.1	0.79	14.8	0.59	82.8	7.4
68	2.4	12.8	10.1	0.79	14.7	0.57	80.3	10.2

Table 7. Cooling capacities 1 tons (net) - GET012 (continued)

EWT	GPM	Total Mbtuh	Sen Mbtuh	SHR	Heat of Rej (Mbtuh)	Comp Pwr (kW)	LWT	Feet Head
68	2.8	12.8	10.1	0.79	14.7	0.56	78.5	13.4
68	3.0	12.8	10.1	0.79	14.7	0.56	77.8	15.1
68	3.2	12.8	10.1	0.79	14.7	0.55	77.2	16.9
68	3.5	12.8	10.1	0.79	14.7	0.55	76.4	19.8
75	1.5	12.5	10.0	0.80	14.8	0.68	94.8	4.4
75	2.0	12.6	10.0	0.80	14.8	0.64	89.8	7.3
75	2.4	12.6	10.0	0.80	14.7	0.63	87.3	10.0
75	2.8	12.6	10.1	0.80	14.7	0.62	85.5	13.1
75	3.0	12.6	10.1	0.80	14.7	0.61	84.8	14.8
75	3.2	12.6	10.1	0.80	14.7	0.61	84.2	16.5
75	3.5	12.6	10.1	0.80	14.7	0.60	83.4	19.4
77	1.5	12.5	10.0	0.80	14.8	0.69	96.8	4.4
77	2.0	12.5	10.0	0.80	14.8	0.66	91.8	7.2
77	2.4	12.5	10.0	0.80	14.7	0.64	89.3	9.9
77	2.8	12.5	10.0	0.80	14.7	0.63	87.5	13.0
77	3.0	12.6	10.0	0.80	14.7	0.63	86.8	14.7
77	3.2	12.6	10.0	0.80	14.7	0.62	86.2	16.4
77	3.5	12.6	10.0	0.80	14.7	0.62	85.4	19.2
86	1.5	12.2	9.9	0.81	14.9	0.78	105.8	4.2
86	2.0	12.2	9.9	0.81	14.8	0.75	100.8	7.0
86	2.4	12.2	9.9	0.81	14.7	0.73	98.3	9.7
86	2.8	12.2	9.9	0.81	14.7	0.71	96.5	12.6
86	3.0	12.2	9.9	0.81	14.7	0.71	95.8	14.3
86	3.2	12.2	9.9	0.81	14.7	0.71	95.2	16.0
86	3.5	12.2	9.9	0.81	14.6	0.70	94.4	18.7
95	1.5	11.8	9.8	0.82	14.9	0.89	114.8	3.7
95	2.0	11.9	9.7	0.82	14.8	0.85	109.8	6.2
95	2.4	11.9	9.8	0.82	14.7	0.83	107.2	8.6
95	2.8	11.9	9.8	0.82	14.6	0.81	105.5	11.3
95	3.0	11.9	9.8	0.82	14.6	0.81	104.8	12.7
95	3.2	11.9	9.8	0.82	14.6	0.80	104.1	14.2
95	3.5	11.9	9.8	0.82	14.6	0.80	103.3	16.7
105	1.5	11.4	9.5	0.84	14.9	1.01	124.8	3.8
105	2.0	11.4	9.6	0.84	14.7	0.97	119.7	6.1
105	2.4	11.4	9.6	0.84	14.7	0.95	117.2	8.3
105	2.8	11.4	9.6	0.84	14.6	0.93	115.4	10.9
105	3.0	11.4	9.6	0.84	14.6	0.93	114.7	12.3
105	3.2	11.4	9.6	0.84	14.6	0.94	114.1	13.8
105	3.5	11.4	9.6	0.84	14.6	0.93	113.3	16.2
115	1.5	10.9	9.3	0.86	14.8	1.15	134.8	3.8
115	2.0	10.9	9.3	0.86	14.7	1.11	129.7	6.0
115	2.4	10.9	9.3	0.86	14.6	1.09	127.2	8.1
115	2.8	10.9	9.3	0.86	14.6	1.07	125.4	10.6
115	3.0	10.9	9.3	0.86	14.5	1.06	124.7	12.0
115	3.2	10.9	9.3	0.86	14.5	1.06	124.1	13.4



Performance Data

Table 7. Cooling capacities 1 tons (net) - GET012 (continued)

EWT	GPM	Total Mbtuh	Sen Mbtuh	SHR	Heat of Rej (Mbtuh)	Comp Pwr (kW)	LWT	Feet Head
115	3.5	10.9	9.3	0.86	14.5	1.05	123.3	15.8
120	1.5	10.6	9.2	0.87	14.8	1.23	139.8	3.8
120	2.0	10.6	9.2	0.87	14.7	1.19	134.7	5.9
120	2.4	10.6	9.2	0.87	14.6	1.16	132.2	8.0
120	2.8	10.6	9.2	0.87	14.5	1.14	130.4	10.5
120	3.0	10.6	9.2	0.87	14.5	1.13	129.7	11.8
120	3.2	10.6	9.2	0.87	14.5	1.13	129.0	13.3
120	3.5	10.6	9.2	0.87	14.4	1.12	128.2	15.6

Notes: Cooling performance data is tabulated at 80.6°F DB/66.2°F WB entering air at ANSI/AHRI/ASHRAE/ISO13256-1 rated CFM. For ANSI/AHRI/ASHRAE/ISO13256-1 certified ratings, refer to the ANSI/AHRI/ASHRAE/ISO13256-1 WLHP, GWHP and GLHP performance table. See performance correction tables to correct performance at conditions other than those tabulated. Data shown is for unit performance only. Interpolation is permissible, extrapolation is not. Rated GPM 2.8; Minimum cfm 303; Rated cfm 380; Maximum cfm 456.

Table 8. Heating capacities 1 tons (net) - GET012

EWT	GPM	Total Mbtuh	Heat of Absorb (Mbtuh)	Compr Power (kW)	LWT	Feet Head
25	1.5	7.7	5.4	0.67	17.8	6.9
25	2.0	7.9	5.6	0.68	19.4	11.4
25	2.4	8.1	5.7	0.68	20.2	16.5
25	2.8	8.1	5.8	0.68	20.9	21.2
25	3.0	8.2	5.8	0.68	21.1	23.8
25	3.2	8.2	5.9	0.68	21.3	25.7
25	3.5	8.2	5.8	0.68	21.7	30.6
32	1.5	8.5	6.1	0.69	23.8	6.7
32	2.0	8.7	6.4	0.69	25.6	11.0
32	2.4	8.9	6.5	0.69	26.6	15.1
32	2.8	9.0	6.6	0.69	27.3	19.8
32	3.0	9.0	6.7	0.69	27.6	22.3
32	3.2	9.1	6.7	0.69	27.8	24.9
32	3.5	9.1	6.8	0.70	28.1	29.1
45	1.5	10.1	7.7	0.71	34.8	4.9
45	2.0	10.4	8.0	0.71	37.0	8.1
45	2.4	10.6	8.2	0.71	38.2	11.2
45	2.8	10.7	8.3	0.71	39.1	14.6
45	3.0	10.8	8.3	0.71	39.5	16.5
45	3.2	10.8	8.4	0.71	39.8	18.4
45	3.5	10.9	8.4	0.72	40.2	21.5
55	1.5	11.3	8.9	0.72	43.2	4.7
55	2.0	11.7	9.2	0.73	45.8	7.8
55	2.4	11.9	9.4	0.73	47.1	10.7
55	2.8	12.1	9.6	0.73	48.2	14.1
55	3.0	12.2	9.7	0.73	48.6	15.9
55	3.2	12.2	9.7	0.73	49.0	17.8
55	3.5	12.3	9.7	0.73	49.4	20.7
68	1.5	13.0	10.5	0.74	54.1	4.5
68	2.0	13.4	10.9	0.75	57.1	7.4

Table 8. Heating capacities 1 tons (net) - GET012 (continued)

EWT	GPM	Total Mbtuh	Heat of Absorb (Mbtuh)	Compr Power (kW)	LWT	Feet Head
68	2.4	13.7	11.1	0.75	58.7	10.2
68	2.8	13.9	11.3	0.75	59.9	13.4
68	3.0	14.0	11.4	0.75	60.4	15.1
68	3.2	14.0	11.5	0.76	60.8	16.9
68	3.5	14.1	11.6	0.76	61.4	19.8
75	1.5	13.9	11.3	0.75	59.9	4.4
75	2.0	14.4	11.8	0.76	63.2	7.3
75	2.4	14.7	12.1	0.76	65.0	10.0
75	2.8	14.9	12.3	0.77	66.2	13.1
75	3.0	15.0	12.3	0.77	66.8	14.8
75	3.2	15.0	12.4	0.77	67.3	16.5
75	3.5	15.2	12.5	0.77	67.9	19.4
77	1.5	14.1	11.6	0.76	61.6	4.4
77	2.0	14.7	12.1	0.77	64.9	7.2
77	2.4	14.9	12.3	0.77	66.7	9.9
77	2.8	15.2	12.5	0.77	68.1	13.0
77	3.0	15.2	12.6	0.77	68.6	14.7
77	3.2	15.3	12.7	0.77	69.1	16.4
77	3.5	15.4	12.8	0.78	69.7	19.2
86	1.5	15.4	12.7	0.78	69.1	4.2
86	2.0	15.9	13.3	0.79	72.8	7.0
86	2.4	16.3	13.6	0.79	74.7	9.7
86	2.8	16.5	13.7	0.80	76.2	12.6
86	3.0	16.6	13.8	0.80	76.8	14.3
86	3.2	16.7	13.9	0.80	77.3	16.0
86	3.5	16.8	14.0	0.80	78.0	18.7

Notes: Heating performance data is tabulated at 68°F DB entering air at ANSI/AHRI/ASHRAE/ISO13256-1 rated cfm. For ANSI/AHRI/ASHRAE/ISO13256-1 certified ratings, refer to the ANSI/AHRI/ASHRAE/ISO13256-1 WLHP, GWHP and GLHP performance table. See performance correction tables to correct performance at conditions other than those tabulated. Data shown is for unit performance only. Interpolation is permissible, extrapolation is not. Rated GPM 2.8; Minimum cfm 303; Rated cfm 380; Maximum cfm 456.

Table 9. Cooling capacities 1.25 tons (net) - GET015

EWT	GPM	Total Mbtuh	Sen Mbtuh	SHR	Heat of Rej (Mbtuh)	Comp Pwr (kW)	LWT	Feet Head
45	1.9	16.9	14.0	0.83	18.5	0.49	64.8	4.6
45	2.3	16.9	14.0	0.83	18.4	0.45	61.0	6.6
45	2.8	17.0	14.1	0.83	18.4	0.42	58.2	9.3
45	3.5	17.1	14.1	0.83	18.4	0.39	55.5	13.8
45	3.8	17.1	14.1	0.82	18.5	0.38	54.7	15.9
45	4.1	17.1	14.1	0.82	18.4	0.38	54.0	18.2
45	4.4	17.1	14.1	0.83	18.3	0.37	53.4	20.4
55	1.9	16.7	14.0	0.84	18.8	0.61	75.0	4.4
55	2.3	16.7	13.9	0.83	18.7	0.57	71.2	6.4
55	2.8	16.8	14.0	0.83	18.6	0.54	68.3	9.0
55	3.5	16.8	14.0	0.83	18.6	0.51	65.6	13.3
55	3.8	16.8	14.0	0.83	18.5	0.50	64.8	15.3



Performance Data

Table 9. Cooling capacities 1.25 tons (net) - GET015 (continued)

EWT	GPM	Total Mbtuh	Sen Mbtuh	SHR	Heat of Rej (Mbtuh)	Comp Pwr (kW)	LWT	Feet Head
55	4.1	16.8	14.0	0.83	18.5	0.50	64.0	17.5
55	4.4	16.8	14.0	0.83	18.5	0.49	63.5	19.6
68	1.9	16.3	13.8	0.85	18.9	0.76	88.2	4.2
68	2.3	16.4	13.8	0.85	18.8	0.72	84.4	6.1
68	2.8	16.4	13.8	0.84	18.8	0.69	81.4	8.6
68	3.5	16.4	13.9	0.84	18.7	0.67	78.7	12.7
68	3.8	16.5	13.9	0.84	18.7	0.66	77.8	14.6
68	4.1	16.5	13.9	0.84	18.7	0.65	77.1	16.7
68	4.4	16.5	13.9	0.84	18.7	0.65	76.5	18.7
75	1.9	16.1	13.7	0.85	18.9	0.84	95.2	4.1
75	2.3	16.1	13.7	0.85	18.9	0.81	91.4	5.9
75	2.8	16.1	13.8	0.85	18.8	0.78	88.4	8.4
75	3.5	16.2	13.8	0.85	18.7	0.75	85.7	12.4
75	3.8	16.2	13.8	0.85	18.7	0.74	84.8	14.3
75	4.1	16.2	13.8	0.85	18.7	0.74	84.1	16.3
75	4.4	16.2	13.8	0.85	18.7	0.73	83.5	18.3
77	1.9	16.0	13.7	0.86	19.0	0.87	97.2	4.1
77	2.3	16.0	13.7	0.86	18.9	0.83	93.4	5.9
77	2.8	16.1	13.7	0.85	18.8	0.80	90.4	8.3
77	3.5	16.1	13.7	0.85	18.7	0.78	87.7	12.3
77	3.8	16.1	13.7	0.85	18.7	0.77	86.8	14.2
77	4.1	16.1	13.8	0.86	18.7	0.76	86.1	16.2
77	4.4	16.1	13.7	0.85	18.7	0.75	85.5	18.1
86	1.9	15.6	13.6	0.87	19.0	0.99	106.2	4.0
86	2.3	15.6	13.6	0.87	18.9	0.95	102.4	5.7
86	2.8	15.6	13.6	0.87	18.8	0.92	99.4	8.1
86	3.5	15.7	13.6	0.87	18.7	0.89	96.7	11.9
86	3.8	15.7	13.6	0.87	18.7	0.88	95.8	13.8
86	4.1	15.7	13.6	0.87	18.6	0.87	95.1	15.7
86	4.4	15.7	13.6	0.87	18.6	0.87	94.5	17.6
95	1.9	15.2	13.4	0.89	19.0	1.13	115.3	3.7
95	2.3	15.2	13.4	0.88	18.9	1.08	111.4	5.3
95	2.8	15.2	13.4	0.88	18.8	1.05	108.4	7.5
95	3.5	15.2	13.4	0.88	18.7	1.02	105.7	11.2
95	3.8	15.2	13.4	0.88	18.6	1.01	104.8	12.9
95	4.1	15.2	13.4	0.88	18.6	1.00	104.1	14.8
95	4.4	15.2	13.4	0.88	18.6	1.00	103.5	16.6
105	1.9	14.6	13.2	0.90	19.1	1.30	125.3	3.6
105	2.3	14.6	13.2	0.91	18.9	1.25	121.4	5.2
105	2.8	14.6	13.2	0.91	18.8	1.22	118.4	7.3
105	3.5	14.6	13.2	0.91	18.6	1.19	115.7	10.9
105	3.8	14.6	13.2	0.91	18.6	1.18	114.8	12.6
105	4.1	14.6	13.2	0.91	18.6	1.17	114.1	14.4
105	4.4	14.6	13.2	0.91	18.5	1.16	113.5	16.1
115	1.9	14.1	13.1	0.93	19.4	1.54	135.7	3.5

Table 9. Cooling capacities 1.25 tons (net) - GET015 (continued)

EWT	GPM	Total Mbtuh	Sen Mbtuh	SHR	Heat of Rej (Mbtuh)	Comp Pwr (kW)	LWT	Feet Head
115	2.3	14.1	13.0	0.93	19.1	1.48	131.6	5.0
115	2.8	14.0	13.0	0.93	19.0	1.44	128.5	7.1
115	3.5	14.0	13.0	0.93	18.8	1.40	125.7	10.6
115	3.8	14.0	13.0	0.93	18.8	1.39	124.9	12.2
115	4.1	14.0	13.0	0.93	18.7	1.38	124.1	14.0
115	4.4	14.0	13.0	0.93	18.7	1.37	123.5	15.7
120	1.9	13.7	13.0	0.94	19.2	1.60	140.4	3.7
120	2.3	13.7	13.0	0.94	19.0	1.56	136.6	5.1
120	2.8	13.7	12.9	0.94	18.9	1.52	133.5	7.0
120	3.5	13.7	12.9	0.95	18.7	1.48	130.7	10.4
120	3.8	13.7	12.9	0.95	18.7	1.47	129.8	12.0
120	4.1	13.6	12.9	0.95	18.6	1.46	129.1	13.7
120	4.4	13.6	12.9	0.95	18.6	1.45	128.5	15.4

Notes: Cooling performance data is tabulated at 80.6°F DB/66.2°F WB entering air at ANSI/AHRI/ASHRAE/ISO13256-1 rated CFM. For ANSI/AHRI/ASHRAE/ISO13256-1 certified ratings, refer to the ANSI/AHRI/ASHRAE/ISO13256-1 WLHP, GWHP and GLHP performance table. See performance correction tables to correct performance at conditions other than those tabulated. Data shown is for unit performance only. Interpolation is permissible, extrapolation is not. Rated GPM 3.5; Minimum cfm 432; Rated cfm 540; Maximum cfm 648.

Table 10. Heating capacities 1.25 tons (net) - GET015

EWT	GPM	Total Mbtuh	Heat of Absorb (Mbtuh)	Compr Power (kW)	LWT	Feet Head
25	1.9	9.7	6.9	0.82	17.7	6.2
25	2.3	9.9	7.0	0.83	18.9	8.9
25	2.8	10.0	7.2	0.83	19.9	12.5
25	3.5	10.2	7.4	0.83	20.8	18.4
25	3.8	10.3	7.4	0.83	21.1	21.2
25	4.1	10.3	7.5	0.83	21.4	24.2
25	4.4	10.3	7.5	0.83	21.6	27.1
32	1.9	10.6	7.7	0.84	23.8	6.0
32	2.3	10.8	8.0	0.84	25.1	8.6
32	2.8	11.0	8.1	0.85	26.2	12.1
32	3.5	11.2	8.3	0.85	27.3	17.8
32	3.8	11.3	8.4	0.85	27.6	20.6
32	4.1	11.3	8.4	0.85	27.9	23.5
32	4.4	11.4	8.5	0.85	28.1	26.3
45	1.9	12.6	9.6	0.87	34.7	4.6
45	2.3	12.9	9.9	0.87	36.4	6.6
45	2.8	13.2	10.2	0.88	37.7	9.3
45	3.5	13.4	10.4	0.88	39.1	13.8
45	3.8	13.5	10.5	0.88	39.5	15.9
45	4.1	13.6	10.5	0.88	39.9	18.2
45	4.4	13.6	10.6	0.88	40.2	20.4
55	1.9	14.1	11.1	0.89	43.2	4.4
55	2.3	14.5	11.5	0.89	45.0	6.4
55	2.8	14.8	11.8	0.90	46.6	9.0
55	3.5	15.1	12.1	0.90	48.1	13.3



Performance Data

Table 10. Heating capacities 1.25 tons (net) - GET015 (continued)

EWT	GPM	Total Mbtuh	Heat of Absorb (Mbtuh)	Compr Power (kW)	LWT	Feet Head
55	3.8	15.2	12.2	0.90	48.6	15.3
55	4.1	15.3	12.2	0.90	49.0	17.5
55	4.4	15.4	12.3	0.90	49.4	19.6
68	1.9	16.3	13.2	0.91	54.0	4.2
68	2.3	16.7	13.6	0.90	56.2	6.1
68	2.8	17.1	14.0	0.91	58.0	8.6
68	3.5	17.4	14.4	0.91	59.8	12.7
68	3.8	17.6	14.5	0.91	60.4	14.6
68	4.1	17.7	14.6	0.91	60.9	16.7
68	4.4	17.8	14.7	0.91	61.3	18.7
75	1.9	17.4	14.3	0.91	59.7	4.1
75	2.3	17.9	14.8	0.91	62.1	5.9
75	2.8	18.3	15.2	0.91	64.1	8.4
75	3.5	18.7	15.6	0.91	66.1	12.4
75	3.8	18.9	15.8	0.91	66.7	14.3
75	4.1	19.0	15.9	0.91	67.3	16.3
75	4.4	19.1	16.0	0.91	67.7	18.3
77	1.9	17.7	14.6	0.91	61.4	4.1
77	2.3	18.3	15.2	0.91	63.8	5.9
77	2.8	18.7	15.6	0.91	65.9	8.3
77	3.5	19.1	16.0	0.91	67.9	12.3
77	3.8	19.2	16.1	0.91	68.5	14.2
77	4.1	19.4	16.3	0.91	69.1	16.2
77	4.4	19.5	16.4	0.91	69.5	18.1
86	1.9	19.3	16.2	0.91	68.8	4.0
86	2.3	19.8	16.7	0.91	71.4	5.7
86	2.8	20.3	17.2	0.91	73.7	8.1
86	3.5	20.8	17.7	0.90	75.9	11.9
86	3.8	20.9	17.9	0.90	76.6	13.8
86	4.1	21.1	18.1	0.90	77.2	15.7
86	4.4	21.2	18.1	0.90	77.7	17.6

Notes: Heating performance data is tabulated at 68°F DB entering air at ANSI/AHRI/ASHRAE/ISO13256-1 rated cfm. For ANSI/AHRI/ASHRAE/ISO13256-1 certified ratings, refer to the ANSI/AHRI/ASHRAE/ISO13256-1 WLHP, GWHP and GLHP performance table. See performance correction tables to correct performance at conditions other than those tabulated. Data shown is for unit performance only. Interpolation is permissible, extrapolation is not. Rated GPM 3.5; Minimum cfm 432; Rated cfm 540; Maximum cfm 648.

Table 11. Cooling capacities 1.5 tons (net) - GET018

EWT	GPM	Total Mbtuh	Sen Mbtuh	SHR	Heat of Rej (Mbtuh)	Comp Pwr (kW)	LWT	Feet Head
45	2.3	20.1	15.9	0.79	22.5	0.72	65.0	3.8
45	2.9	19.9	15.8	0.79	22.2	0.67	60.3	6.0
45	3.6	19.8	15.8	0.80	22.0	0.64	57.2	8.7
45	4.2	19.7	15.8	0.80	21.8	0.62	55.4	11.4
45	4.6	19.7	15.7	0.80	21.8	0.61	54.5	13.4
45	5.0	19.6	15.6	0.80	21.6	0.60	53.6	15.5
45	5.3	19.6	15.7	0.80	21.6	0.60	53.2	16.9

Table 11. Cooling capacities 1.5 tons (net) - GET018 (continued)

EWT	GPM	Total Mbtuh	Sen Mbtuh	SHR	Heat of Rej (Mbtuh)	Comp Pwr (kW)	LWT	Feet Head
55	2.3	20.0	15.9	0.79	22.9	0.84	75.3	3.7
55	2.9	20.0	15.8	0.79	22.7	0.79	70.6	5.7
55	3.6	19.9	15.8	0.79	22.5	0.76	67.5	8.4
55	4.2	19.9	15.8	0.79	22.4	0.74	65.7	11.0
55	4.6	19.9	15.8	0.79	22.4	0.73	64.7	12.9
55	5.0	19.9	15.8	0.80	22.4	0.73	63.9	14.9
55	5.3	19.9	15.8	0.80	22.3	0.72	63.5	16.2
68	2.3	19.6	15.7	0.80	23.0	1.01	88.4	3.5
68	2.9	19.6	15.7	0.80	22.9	0.96	83.8	5.5
68	3.6	19.6	15.7	0.80	22.8	0.92	80.6	8.0
68	4.2	19.6	15.7	0.80	22.7	0.90	78.8	10.5
68	4.6	19.6	15.7	0.80	22.7	0.90	77.9	12.3
68	5.0	19.6	15.7	0.80	22.6	0.89	77.1	14.2
68	5.3	19.6	15.7	0.80	22.6	0.88	76.6	15.5
75	2.3	19.2	15.6	0.81	23.0	1.10	95.4	3.4
75	2.9	19.3	15.6	0.81	22.8	1.05	90.8	5.4
75	3.6	19.3	15.6	0.81	22.8	1.02	87.6	7.8
75	4.2	19.3	15.6	0.81	22.7	1.00	85.8	10.2
75	4.6	19.3	15.6	0.81	22.7	0.99	84.9	12.0
75	5.0	19.3	15.6	0.81	22.7	0.98	84.1	13.9
75	5.3	19.3	15.6	0.81	22.6	0.98	83.6	15.1
77	2.3	19.1	15.5	0.81	23.0	1.13	97.4	3.4
77	2.9	19.2	15.6	0.81	22.8	1.08	92.7	5.3
77	3.6	19.2	15.6	0.81	22.8	1.04	89.6	7.8
77	4.2	19.2	15.6	0.81	22.7	1.03	87.8	10.2
77	4.6	19.2	15.6	0.81	22.7	1.02	86.9	11.9
77	5.0	19.2	15.6	0.81	22.6	1.01	86.1	13.8
77	5.3	19.2	15.6	0.81	22.6	1.00	85.6	15.0
86	2.3	18.6	15.3	0.83	22.9	1.26	106.3	3.3
86	2.9	18.6	15.4	0.83	22.7	1.21	101.7	5.2
86	3.6	18.6	15.4	0.82	22.6	1.17	98.6	7.5
86	4.2	18.6	15.4	0.82	22.6	1.15	96.7	9.9
86	4.6	18.7	15.4	0.82	22.6	1.14	95.8	11.6
86	5.0	18.7	15.4	0.82	22.5	1.13	95.0	13.4
86	5.3	18.7	15.4	0.82	22.5	1.13	94.6	14.6
95	2.3	17.9	15.1	0.84	22.7	1.41	115.2	3.0
95	2.9	18.0	15.1	0.84	22.6	1.35	110.6	4.8
95	3.6	18.0	15.1	0.84	22.5	1.32	107.5	7.0
95	4.2	18.0	15.2	0.84	22.4	1.30	105.7	9.1
95	4.6	18.0	15.2	0.84	22.4	1.28	104.7	10.7
95	5.0	18.0	15.2	0.84	22.4	1.28	104.0	12.4
95	5.3	18.0	15.2	0.84	22.4	1.27	103.5	13.6
105	2.3	17.2	14.9	0.86	22.7	1.60	125.2	2.9
105	2.9	17.2	14.9	0.86	22.5	1.54	120.5	4.6
105	3.6	17.3	14.9	0.86	22.4	1.50	117.4	6.8



Performance Data

Table 11. Cooling capacities 1.5 tons (net) - GET018 (continued)

EWT	GPM	Total Mbtuh	Sen Mbtuh	SHR	Heat of Rej (Mbtuh)	Comp Pwr (kW)	LWT	Feet Head
105	4.2	17.3	14.9	0.86	22.3	1.47	115.6	8.9
105	4.6	17.3	14.9	0.86	22.3	1.46	114.7	10.4
105	5.0	17.3	14.9	0.86	22.2	1.45	113.9	12.1
105	5.3	17.3	14.9	0.86	22.2	1.45	113.5	13.2
115	2.3	16.5	14.6	0.89	22.7	1.83	135.2	2.9
115	2.9	16.5	14.6	0.88	22.5	1.76	130.5	4.5
115	3.6	16.5	14.6	0.89	22.3	1.72	127.4	6.6
115	4.2	16.5	14.6	0.89	22.2	1.69	125.6	8.7
115	4.6	16.5	14.6	0.89	22.2	1.68	124.6	10.2
115	5.0	16.5	14.6	0.89	22.2	1.67	123.9	11.8
115	5.3	16.5	14.6	0.89	22.1	1.66	123.4	12.8
120	2.3	15.7	14.2	0.90	22.2	1.90	139.8	3.0
120	2.9	15.8	14.3	0.90	22.1	1.85	135.2	4.5
120	3.6	15.8	14.3	0.90	22.0	1.81	132.2	6.5
120	4.2	15.9	14.3	0.90	21.9	1.78	130.4	8.5
120	4.6	15.9	14.3	0.90	21.9	1.76	129.5	10.0
120	5.0	15.9	14.3	0.90	21.9	1.75	128.8	11.6
120	5.3	15.9	14.4	0.90	21.9	1.75	128.3	12.7

Notes: Cooling performance data is tabulated at 80.6°F DB/66.2°F WB entering air at ANSI/AHRI/ASHRAE/ISO13256-1 rated CFM. For ANSI/AHRI/ASHRAE/ISO13256-1 certified ratings, refer to the ANSI/AHRI/ASHRAE/ISO13256-1 WLHP, GWHP and GLHP performance table. See performance correction tables to correct performance at conditions other than those tabulated. Data shown is for unit performance only. Interpolation is permissible, extrapolation is not. Rated GPM 4.2; Minimum cfm 501; Rated cfm 650; Maximum cfm 780.

Table 12. Heating capacities 1.5 tons (net) GET018

EWT	GPM	Total Mbtuh	Heat of Absorb (Mbtuh)	Compr Power (kW)	LWT	Feet Head
25	2.3	12.3	8.8	1.03	17.2	5.2
25	2.9	12.6	9.1	1.03	18.7	8.1
25	3.6	12.8	9.3	1.04	19.8	11.7
25	4.2	12.9	9.3	1.04	20.6	15.8
25	4.6	12.9	9.4	1.04	20.9	18.3
25	5.0	12.9	9.4	1.04	21.3	21.0
25	5.3	12.9	9.3	1.04	21.5	22.7
32	2.3	13.5	9.9	1.05	23.2	5.0
32	2.9	13.9	10.3	1.06	24.9	7.8
32	3.6	14.1	10.5	1.06	26.2	11.4
32	4.2	14.4	10.7	1.07	26.9	14.9
32	4.6	14.4	10.8	1.07	27.3	17.5
32	5.0	14.5	10.9	1.07	27.7	20.2
32	5.3	14.6	10.9	1.07	27.9	22.0
45	2.3	16.3	12.5	1.11	33.9	3.8
45	2.9	16.8	13.0	1.12	36.1	6.0
45	3.6	17.2	13.3	1.13	37.6	8.7
45	4.2	17.4	13.6	1.13	38.5	11.4
45	4.6	17.6	13.7	1.14	39.1	13.4
45	5.0	17.7	13.8	1.14	39.5	15.5

Table 12. Heating capacities 1.5 tons (net) GET018 (continued)

EWT	GPM	Total Mbtuh	Heat of Absorb (Mbtuh)	Compr Power (kW)	LWT	Feet Head
45	5.3	17.7	13.9	1.14	39.7	16.9
55	2.3	18.5	14.5	1.16	42.1	3.7
55	2.9	19.1	15.1	1.17	44.6	5.7
55	3.6	19.6	15.6	1.18	46.4	8.4
55	4.2	19.9	15.8	1.18	47.5	11.0
55	4.6	20.0	15.9	1.18	48.1	12.9
55	5.0	20.1	16.1	1.19	48.6	14.9
55	5.3	20.2	16.1	1.19	48.9	16.2
68	2.3	21.3	17.2	1.21	52.7	3.5
68	2.9	22.2	18.0	1.22	55.6	5.5
68	3.6	22.6	18.5	1.22	57.7	8.0
68	4.2	22.9	18.7	1.23	59.1	10.5
68	4.6	23.0	18.8	1.22	59.8	12.3
68	5.0	23.2	19.0	1.23	60.4	14.2
68	5.3	23.3	19.1	1.23	60.7	15.5
75	2.3	22.9	18.7	1.23	58.4	3.4
75	2.9	23.7	19.5	1.24	61.6	5.4
75	3.6	24.2	20.0	1.24	63.9	7.8
75	4.2	24.5	20.3	1.24	65.4	10.2
75	4.6	24.6	20.4	1.24	66.1	12.0
75	5.0	24.8	20.6	1.24	66.8	13.9
75	5.3	24.9	20.7	1.24	67.1	15.1
77	2.3	23.4	19.1	1.24	60.0	3.4
77	2.9	24.2	19.9	1.25	63.3	5.3
77	3.6	24.6	20.4	1.24	65.7	7.8
77	4.2	25.0	20.7	1.25	67.1	10.2
77	4.6	25.1	20.9	1.24	67.9	11.9
77	5.0	25.2	21.0	1.24	68.6	13.8
77	5.3	25.3	21.0	1.24	69.0	15.0
86	2.3	25.2	20.9	1.26	67.4	3.3
86	2.9	26.0	21.7	1.25	71.0	5.2
86	3.6	26.4	22.2	1.25	73.7	7.5
86	4.2	26.7	22.5	1.24	75.3	9.9
86	4.6	26.8	22.6	1.24	76.2	11.6
86	5.0	26.9	22.7	1.24	76.9	13.4
86	5.3	27.0	22.8	1.23	77.3	14.6

Notes: Heating performance data is tabulated at 68°F DB entering air at ANSI/AHRI/ASHRAE/ISO13256-1 rated cfm. For ANSI/AHRI/ASHRAE/ISO13256-1 certified ratings, refer to the ANSI/AHRI/ASHRAE/ISO13256-1 WLHP, GWHP and GLHP performance table. See performance correction tables to correct performance at conditions other than those tabulated. Data shown is for unit performance only. Interpolation is permissible, extrapolation is not. Rated GPM 4.2; Minimum cfm 501; Rated cfm 650; Maximum cfm 780.



Performance Data

Table 13. Cooling capacities 2 tons (net) GET024

EWT	GPM	Total Mbtuh	Sen Mbtuh	SHR	Heat of Rej (Mbtuh)	Comp Pwr (kW)	LWT	Feet Head
45	3.0	27.4	20.9	0.76	30.3	0.84	65.2	3.4
45	3.9	27.8	21.0	0.76	30.4	0.77	60.6	5.5
45	4.7	28.0	21.1	0.75	30.5	0.73	58.0	7.6
45	5.6	28.2	21.1	0.75	30.6	0.70	55.9	10.3
45	6.1	28.3	21.2	0.75	30.6	0.69	55.0	12.0
45	6.5	28.4	21.2	0.75	30.7	0.68	54.4	13.4
45	7.0	28.3	21.2	0.75	30.6	0.67	53.7	15.2
55	3.0	26.6	20.5	0.77	30.0	1.01	75.0	3.3
55	3.9	26.9	20.7	0.77	30.1	0.94	70.4	5.2
55	4.7	27.1	20.7	0.76	30.2	0.91	67.8	7.3
55	5.6	27.2	20.7	0.76	30.2	0.87	65.8	9.9
55	6.1	27.3	20.8	0.76	30.3	0.86	64.9	11.5
55	6.5	27.4	20.8	0.76	30.3	0.85	64.3	12.9
55	7.0	27.4	20.8	0.76	30.3	0.84	63.7	14.6
68	3.0	25.6	20.2	0.79	29.8	1.23	87.9	3.2
68	3.9	25.9	20.3	0.78	29.9	1.17	83.3	5.0
68	4.7	26.0	20.3	0.78	29.9	1.13	80.7	6.9
68	5.6	26.1	20.4	0.78	29.9	1.10	78.7	9.4
68	6.1	26.2	20.4	0.78	29.9	1.09	77.8	11.0
68	6.5	26.2	20.4	0.78	29.9	1.08	77.2	12.3
68	7.0	26.3	20.4	0.78	29.9	1.07	76.6	14.0
75	3.0	25.0	19.9	0.80	29.6	1.36	94.8	3.1
75	3.9	25.3	20.0	0.79	29.7	1.30	90.2	4.9
75	4.7	25.4	20.1	0.79	29.7	1.26	87.6	6.8
75	5.6	25.5	20.1	0.79	29.7	1.23	85.6	9.2
75	6.1	25.6	20.1	0.79	29.7	1.22	84.7	10.7
75	6.5	25.6	20.2	0.79	29.7	1.21	84.1	12.0
75	7.0	25.6	20.2	0.79	29.7	1.20	83.5	13.6
77	3.0	24.8	19.9	0.80	29.6	1.40	96.7	3.1
77	3.9	25.1	19.9	0.80	29.6	1.33	92.2	4.9
77	4.7	25.2	20.0	0.79	29.6	1.30	89.6	6.7
77	5.6	25.3	20.1	0.79	29.7	1.27	87.6	9.2
77	6.1	25.4	20.1	0.79	29.7	1.25	86.7	10.6
77	6.5	25.4	20.1	0.79	29.7	1.25	86.1	11.9
77	7.0	25.5	20.1	0.79	29.7	1.24	85.5	13.5
86	3.0	24.0	19.5	0.81	29.3	1.57	105.6	3.0
86	3.9	24.2	19.6	0.81	29.3	1.50	101.0	4.7
86	4.7	24.3	19.7	0.81	29.4	1.47	98.5	6.6
86	5.6	24.5	19.7	0.81	29.4	1.44	96.5	8.9
86	6.1	24.5	19.7	0.81	29.4	1.43	95.6	10.3
86	6.5	24.6	19.8	0.80	29.4	1.42	95.0	11.6
86	7.0	24.6	19.8	0.80	29.4	1.41	94.4	13.2
95	3.0	23.0	19.2	0.83	29.1	1.77	114.4	2.7
95	3.9	23.3	19.3	0.83	29.1	1.70	109.9	4.3

Table 13. Cooling capacities 2 tons (net) GET024 (continued)

EWT	GPM	Total Mbtuh	Sen Mbtuh	SHR	Heat of Rej (Mbtuh)	Comp Pwr (kW)	LWT	Feet Head
95	4.7	23.4	19.3	0.82	29.1	1.66	107.4	6.0
95	5.6	23.5	19.3	0.82	29.1	1.63	105.4	8.2
95	6.1	23.6	19.3	0.82	29.1	1.61	104.5	9.5
95	6.5	23.6	19.4	0.82	29.1	1.60	103.9	10.6
95	7.0	23.6	19.4	0.82	29.1	1.59	103.3	12.1
105	3.0	21.9	18.7	0.86	28.8	2.01	124.2	2.6
105	3.9	22.2	18.8	0.85	28.8	1.93	119.7	4.2
105	4.7	22.3	18.9	0.85	28.7	1.89	117.2	5.8
105	5.6	22.4	18.9	0.85	28.7	1.86	115.3	7.9
105	6.1	22.4	18.9	0.84	28.7	1.84	114.4	9.2
105	6.5	22.4	19.0	0.84	28.7	1.84	113.8	10.3
105	7.0	22.5	19.0	0.84	28.7	1.83	113.2	11.8
115	3.0	20.7	18.3	0.88	28.4	2.28	134.0	2.6
115	3.9	20.9	18.4	0.88	28.4	2.20	129.6	4.1
115	4.7	21.0	18.4	0.88	28.4	2.15	127.1	5.7
115	5.6	21.1	18.4	0.87	28.3	2.12	125.1	7.7
115	6.1	21.1	18.5	0.87	28.3	2.11	124.3	9.0
115	6.5	21.2	18.5	0.87	28.3	2.09	123.7	10.1
115	7.0	21.2	18.5	0.87	28.3	2.08	123.1	11.5
120	3.0	20.1	18.0	0.89	28.3	2.39	138.8	2.7
120	3.9	20.3	18.1	0.89	28.2	2.32	134.5	4.1
120	4.7	20.4	18.1	0.89	28.2	2.27	132.0	5.6
120	5.6	20.5	18.2	0.89	28.2	2.24	130.1	7.6
120	6.1	20.6	18.2	0.88	28.1	2.22	129.2	8.9
120	6.5	20.6	18.2	0.88	28.1	2.21	128.6	9.9
120	7.0	20.6	18.2	0.88	28.1	2.20	128.0	11.3

Notes: Cooling performance data is tabulated at 80.6°F DB/66.2°F WB entering air at ANSI/AHRI/ASHRAE/ISO13256-1 rated CFM. For ANSI/AHRI/ASHRAE/ISO13256-1 certified ratings, refer to the ANSI/AHRI/ASHRAE/ISO13256-1 WLHP, GWHP and GLHP performance table. See performance correction tables to correct performance at conditions other than those tabulated. Data shown is for unit performance only. Interpolation is permissible, extrapolation is not. Rated GPM 5.6; Minimum cfm 656; Rated cfm 820; Maximum cfm 984.

Table 14. Heating capacities 2 tons (net) GET024

EWT	GPM	Total Mbtuh	Heat of Absorb (Mbtuh)	Compr Power (kW)	LWT	Feet Head
25	3.0	14.8	10.4	1.30	18.1	4.7
25	3.9	15.3	10.8	1.30	19.5	7.4
25	4.7	15.5	11.1	1.31	20.3	10.3
25	5.6	15.8	11.3	1.30	21.0	14.0
25	6.1	15.9	11.4	1.31	21.3	16.2
25	6.5	15.9	11.5	1.31	21.5	18.1
25	7.0	16.0	11.6	1.31	21.7	20.6
32	3.0	16.4	12.0	1.31	24.0	4.6
32	3.9	17.0	12.5	1.32	25.6	7.2
32	4.7	17.3	12.8	1.32	26.6	10.0
32	5.6	17.6	13.1	1.32	27.3	13.5
32	6.1	17.7	13.2	1.33	27.7	15.7



Performance Data

Table 14. Heating capacities 2 tons (net) GET024 (continued)

EWT	GPM	Total Mbtuh	Heat of Absorb (Mbtuh)	Compr Power (kW)	LWT	Feet Head
32	6.5	17.8	13.3	1.33	27.9	17.5
32	7.0	17.9	13.3	1.33	28.2	20.0
45	3.0	19.9	15.3	1.35	34.8	3.4
45	3.9	20.6	15.9	1.36	36.8	5.5
45	4.7	20.9	16.3	1.36	38.1	7.6
45	5.6	21.3	16.6	1.37	39.1	10.3
45	6.1	21.4	16.8	1.37	39.5	12.0
45	6.5	21.5	16.8	1.37	39.8	13.4
45	7.0	21.6	17.0	1.37	40.2	15.2
55	3.0	22.5	17.8	1.38	43.1	3.3
55	3.9	23.3	18.5	1.39	45.5	5.2
55	4.7	23.7	19.0	1.40	46.9	7.3
55	5.6	24.1	19.3	1.40	48.1	9.9
55	6.1	24.3	19.5	1.40	48.6	11.5
55	6.5	24.4	19.6	1.40	49.0	12.9
55	7.0	24.5	19.7	1.41	49.4	14.6
68	3.0	26.0	21.1	1.43	53.9	3.2
68	3.9	26.8	21.9	1.44	56.8	5.0
68	4.7	27.4	22.4	1.45	58.5	6.9
68	5.6	27.8	22.9	1.46	59.8	9.4
68	6.1	28.0	23.0	1.46	60.5	11.0
68	6.5	28.1	23.1	1.46	60.9	12.3
68	7.0	28.3	23.3	1.46	61.4	14.0
75	3.0	27.8	22.9	1.46	59.8	3.1
75	3.9	28.8	23.8	1.48	62.8	4.9
75	4.7	29.4	24.3	1.49	64.7	6.8
75	5.6	29.8	24.7	1.49	66.2	9.2
75	6.1	30.0	24.9	1.49	66.8	10.7
75	6.5	30.1	25.0	1.49	67.3	12.0
75	7.0	30.3	25.1	1.50	67.8	13.6
77	3.0	28.4	23.4	1.47	61.4	3.1
77	3.9	29.3	24.3	1.49	64.6	4.9
77	4.7	29.9	24.8	1.49	66.4	6.7
77	5.6	30.3	25.2	1.50	68.0	9.2
77	6.1	30.5	25.4	1.50	68.7	10.6
77	6.5	30.7	25.6	1.51	69.1	11.9
77	7.0	30.9	25.7	1.51	69.7	13.5
86	3.0	30.7	25.6	1.51	69.0	3.0
86	3.9	31.8	26.6	1.53	72.4	4.7
86	4.7	32.4	27.1	1.54	74.5	6.6
86	5.6	32.8	27.5	1.56	76.2	8.9

Table 14. Heating capacities 2 tons (net) GET024 (continued)

EWT	GPM	Total Mbtuh	Heat of Absorb (Mbtuh)	Compr Power (kW)	LWT	Feet Head
86	6.1	33.0	27.7	1.56	76.9	10.3
86	6.5	33.1	27.8	1.56	77.5	11.6
86	7.0	33.3	27.9	1.57	78.0	13.2

Notes: Heating performance data is tabulated at 68°F DB entering air at ANSI/AHRI/ASHRAE/ISO13256-1 rated cfm. For ANSI/AHRI/ASHRAE/ISO13256-1 certified ratings, refer to the ANSI/AHRI/ASHRAE/ISO13256-1 WLHP, GWHP and GLHP performance table. See performance correction tables to correct performance at conditions other than those tabulated. Data shown is for unit performance only. Interpolation is permissible, extrapolation is not. Rated GPM 5.6; Minimum cfm 656; Rated cfm 820; Maximum cfm 984.

Table 15. Cooling capacities 3 tons (net) - GET036

EWT	GPM	Total Mbtuh	Sen Mbtuh	SHR	Heat of Rej (Mbtuh)	Comp Pwr (kW)	LWT	Feet Head
45	4.5	41.9	31.5	0.75	46.1	1.23	65.5	5.6
45	5.8	42.1	31.7	0.75	46.0	1.14	60.9	8.8
45	7.1	42.3	31.7	0.75	46.0	1.08	57.9	12.5
45	8.4	42.4	31.8	0.75	46.0	1.04	55.9	16.8
45	9.1	42.5	31.9	0.75	46.0	1.02	55.1	19.3
45	9.8	42.6	31.9	0.75	46.0	1.01	54.4	22.0
45	10.5	42.6	31.9	0.75	46.0	0.99	53.8	24.8
55	4.5	40.6	31.0	0.76	45.6	1.45	75.2	5.4
55	5.8	40.9	31.2	0.76	45.6	1.36	70.7	8.4
55	7.1	41.1	31.2	0.76	45.5	1.31	67.8	12.0
55	8.4	41.2	31.2	0.76	45.5	1.27	65.8	16.1
55	9.1	41.2	31.3	0.76	45.5	1.26	65.0	18.5
55	9.8	41.2	31.3	0.76	45.5	1.25	64.3	21.1
55	10.5	41.3	31.3	0.76	45.5	1.23	63.7	23.8
68	4.5	38.9	30.4	0.78	44.9	1.74	87.9	5.2
68	5.8	39.1	30.5	0.78	44.8	1.66	83.4	8.0
68	7.1	39.3	30.5	0.78	44.7	1.60	80.6	11.5
68	8.4	39.4	30.6	0.78	44.7	1.57	78.6	15.4
68	9.1	39.4	30.5	0.77	44.7	1.55	77.8	17.7
68	9.8	39.4	30.6	0.78	44.7	1.54	77.1	20.1
68	10.5	39.5	30.6	0.78	44.7	1.53	76.5	22.7
75	4.5	37.9	30.0	0.79	44.4	1.91	94.7	5.0
75	5.8	38.1	30.1	0.79	44.4	1.82	90.3	7.9
75	7.1	38.3	30.1	0.79	44.3	1.77	87.5	11.2
75	8.4	38.3	30.1	0.78	44.3	1.74	85.5	15.0
75	9.1	38.4	30.1	0.79	44.3	1.72	84.7	17.3
75	9.8	38.4	30.2	0.78	44.2	1.71	84.0	19.7
75	10.5	38.4	30.2	0.78	44.2	1.70	83.4	22.2
77	4.5	37.6	29.9	0.80	44.3	1.96	96.7	5.0
77	5.8	37.8	30.0	0.79	44.2	1.87	92.2	7.8
77	7.1	38.0	30.0	0.79	44.2	1.82	89.4	11.1
77	8.4	38.1	30.1	0.79	44.1	1.78	87.5	14.9
77	9.1	38.1	30.1	0.79	44.1	1.77	86.7	17.2
77	9.8	38.1	30.1	0.79	44.1	1.76	86.0	19.5
77	10.5	38.1	30.1	0.79	44.1	1.75	85.4	22.0



Performance Data

Table 15. Cooling capacities 3 tons (net) - GET036 (continued)

EWT	GPM	Total Mbtuh	Sen Mbtuh	SHR	Heat of Rej (Mbtuh)	Comp Pwr (kW)	LWT	Feet Head
86	4.5	36.2	29.3	0.81	43.7	2.19	105.4	4.9
86	5.8	36.4	29.4	0.81	43.6	2.10	101.0	7.6
86	7.1	36.5	29.4	0.80	43.5	2.05	98.3	10.8
86	8.4	36.6	29.5	0.80	43.5	2.01	96.4	14.5
86	9.1	36.7	29.5	0.80	43.5	1.99	95.5	16.7
86	9.8	36.7	29.6	0.81	43.5	1.98	94.9	19.0
86	10.5	36.7	29.5	0.80	43.5	1.97	94.3	21.4
95	4.5	34.7	28.8	0.83	43.1	2.46	114.2	4.5
95	5.8	34.9	28.9	0.83	43.0	2.36	109.8	7.0
95	7.1	35.0	28.9	0.82	42.9	2.30	107.1	10.0
95	8.4	35.1	28.9	0.82	42.9	2.27	105.2	13.5
95	9.1	35.2	28.9	0.82	42.8	2.24	104.4	15.5
95	9.8	35.2	29.0	0.82	42.8	2.23	103.7	17.7
95	10.5	35.2	29.0	0.82	42.8	2.22	103.1	20.0
105	4.5	32.9	28.1	0.85	42.4	2.79	123.9	4.3
105	5.8	33.1	28.2	0.85	42.3	2.68	119.6	6.8
105	7.1	33.2	28.2	0.85	42.2	2.62	116.9	9.7
105	8.4	33.3	28.2	0.85	42.1	2.58	115.0	13.1
105	9.1	33.4	28.2	0.85	42.1	2.56	114.2	15.1
105	9.8	33.4	28.3	0.85	42.1	2.54	113.6	17.2
105	10.5	33.4	28.3	0.85	42.0	2.53	113.0	19.4
115	4.5	31.0	27.3	0.88	41.8	3.16	133.6	4.2
115	5.8	31.2	27.4	0.88	41.6	3.05	129.3	6.6
115	7.1	31.3	27.5	0.88	41.5	2.98	126.7	9.5
115	8.4	31.4	27.5	0.88	41.4	2.94	124.9	12.8
115	9.1	31.4	27.5	0.88	41.4	2.92	124.1	14.7
115	9.8	31.4	27.5	0.87	41.3	2.90	123.4	16.7
115	10.5	31.5	27.5	0.87	41.3	2.89	122.9	18.9
120	4.5	30.0	26.9	0.89	41.3	3.30	138.4	4.4
120	5.8	30.2	26.9	0.89	41.2	3.21	134.2	6.7
120	7.1	30.3	27.0	0.89	41.1	3.15	131.6	9.4
120	8.4	30.4	27.0	0.89	41.0	3.10	129.8	12.5
120	9.1	30.4	27.0	0.89	40.9	3.08	129.0	14.4
120	9.8	30.4	27.0	0.89	40.9	3.06	128.3	16.5
120	10.5	30.4	27.0	0.89	40.9	3.05	127.8	18.7

Notes: Cooling performance data is tabulated at 80.6°F DB/66.2°F WB entering air at ANSI/AHRI/ASHRAE/ISO13256-1 rated CFM. For ANSI/AHRI/ASHRAE/ISO13256-1 certified ratings, refer to the ANSI/AHRI/ASHRAE/ISO13256-1 WLHP, GWHP and GLHP performance table. See performance correction tables to correct performance at conditions other than those tabulated. Data shown is for unit performance only. Interpolation is permissible, extrapolation is not. Rated GPM 8.4; Minimum cfm 936; Rated cfm 1170; Maximum cfm 1404.

Table 16. Heating capacities 3 tons (net) - GET036

EWT	GPM	Total Mbtuh	Heat of Absorb (Mbtuh)	Compr Power (kW)	LWT	Feet Head
25	4.5	23.4	16.9	1.90	17.5	7.6
25	5.8	23.9	17.4	1.90	19.0	11.8
25	7.1	24.3	17.8	1.90	20.0	16.8

Table 16. Heating capacities 3 tons (net) - GET036 (continued)

EWT	GPM	Total Mbtuh	Heat of Absorb (Mbtuh)	Compr Power (kW)	LWT	Feet Head
25	8.4	24.6	18.1	1.90	20.7	22.5
25	9.1	24.6	18.1	1.90	21.0	25.8
25	9.8	24.7	18.2	1.90	21.3	29.4
25	10.5	24.8	18.3	1.90	21.5	33.2
32	4.5	25.7	19.1	1.92	23.5	7.4
32	5.8	26.4	19.8	1.93	25.2	11.5
32	7.1	26.8	20.2	1.93	26.3	16.3
32	8.4	27.0	20.5	1.92	27.1	21.8
32	9.1	27.2	20.6	1.92	27.5	25.1
32	9.8	27.3	20.7	1.92	27.8	28.5
32	10.5	27.3	20.8	1.92	28.0	32.2
45	4.5	30.9	24.0	2.00	34.3	5.6
45	5.8	31.6	24.8	1.99	36.5	8.8
45	7.1	32.1	25.3	1.99	37.9	12.5
45	8.4	32.4	25.6	1.99	38.9	16.8
45	9.1	32.5	25.7	1.99	39.4	19.3
45	9.8	32.6	25.8	1.99	39.7	22.0
45	10.5	32.7	25.9	1.98	40.1	24.8
55	4.5	34.7	27.7	2.05	42.7	5.4
55	5.8	35.7	28.7	2.05	45.1	8.4
55	7.1	36.2	29.2	2.05	46.8	12.0
55	8.4	36.6	29.6	2.05	48.0	16.1
55	9.1	36.7	29.7	2.05	48.5	18.5
55	9.8	36.8	29.8	2.05	48.9	21.1
55	10.5	36.9	29.9	2.05	49.3	23.8
68	4.5	40.1	32.8	2.13	53.4	5.2
68	5.8	41.2	33.9	2.14	56.3	8.0
68	7.1	41.8	34.5	2.13	58.3	11.5
68	8.4	42.2	34.9	2.13	59.7	15.4
68	9.1	42.3	35.0	2.13	60.3	17.7
68	9.8	42.5	35.2	2.13	60.8	20.1
68	10.5	42.6	35.3	2.13	61.3	22.7
75	4.5	42.9	35.5	2.17	59.2	5.0
75	5.8	44.2	36.8	2.19	62.3	7.9
75	7.1	44.9	37.5	2.19	64.5	11.2
75	8.4	45.4	37.9	2.19	66.0	15.0
75	9.1	45.5	38.0	2.18	66.6	17.3
75	9.8	45.6	38.1	2.19	67.2	19.7
75	10.5	45.7	38.2	2.18	67.7	22.2
77	4.5	43.8	36.3	2.19	60.9	5.0
77	5.8	45.1	37.6	2.20	64.0	7.8
77	7.1	45.8	38.3	2.21	66.2	11.1
77	8.4	46.2	38.7	2.20	67.8	14.9
77	9.1	46.4	38.8	2.20	68.5	17.2
77	9.8	46.5	38.9	2.20	69.1	19.5



Performance Data

Table 16. Heating capacities 3 tons (net) - GET036 (continued)

EWT	GPM	Total Mbtuh	Heat of Absorb (Mbtuh)	Compr Power (kW)	LWT	Feet Head
77	10.5	46.6	39.0	2.20	69.6	22.0
86	4.5	47.7	39.9	2.27	68.3	4.9
86	5.8	49.1	41.3	2.29	71.8	7.6
86	7.1	49.9	42.1	2.30	74.2	10.8
86	8.4	50.3	42.5	2.30	75.9	14.5
86	9.1	50.5	42.6	2.30	76.6	16.7
86	9.8	50.6	42.7	2.30	77.3	19.0
86	10.5	50.6	42.8	2.30	77.9	21.4

Notes: Heating performance data is tabulated at 68°F DB entering air at ANSI/AHRI/ASHRAE/ISO13256-1 rated cfm. For ANSI/AHRI/ASHRAE/ISO13256-1 certified ratings, refer to the ANSI/AHRI/ASHRAE/ISO13256-1 WLHP, GWHP and GLHP performance table. See performance correction tables to correct performance at conditions other than those tabulated. Data shown is for unit performance only. Interpolation is permissible, extrapolation is not. Rated GPM 8.4; Minimum cfm 936; Rated cfm 1170; Maximum cfm 1404.

Table 17. Correction factors for variation in entering air temperature

Cooling Entering Air WB°F	Cooling Capacity	Cooling Input Watts	Sensible vs. Entering Dry Bulb Multipliers					Heating Entering Air DB°F	Heating Capacity	Heating Input Watts
			65.6	70.6	75.6	80.6	85.6			
49.4	0.954	1.005	0.995	1.059	1.123	*	*	53.0	1.025	0.853
56.3	0.953	1.005	0.816	1.036	1.122	*	*	58.0	1.017	0.899
60.3	0.952	1.006	0.612	0.846	1.070	*	*	63.0	1.012	0.950
63.2	0.963	1.004	0.466	0.700	0.926	1.150	*	68.0	1.000	1.000
66.2	1.000	1.000	—	0.545	0.773	1.000	1.221	73.0	0.992	1.055
72.1	1.087	0.992	—	—	0.464	0.696	0.920	78.0	0.984	1.116
77.1	1.166	0.983	—	—	—	0.431	0.653	83.0	0.975	1.179

Table 18. Correction factors for variation in airflow

Model	Entering CFM	Cooling Capacity	Sensible Capacity	Cooling Input Watts	Heating Capacity	Heating Input Watts
GET009	272	0.961	0.868	1.004	0.989	1.098
GET009	289	0.972	0.902	1.003	0.993	1.068
GET009	306	0.982	0.934	1.002	0.996	1.043
GET009	323	0.991	0.967	1.001	0.998	1.020
GET009	340	1.000	1.000	1.000	1.000	1.000
GET009	357	1.009	1.032	0.999	1.003	0.984
GET009	374	1.017	1.064	0.998	1.004	0.968
GET009	391	1.024	1.094	0.998	1.006	0.954
GET009	408	1.031	1.124	0.997	1.008	0.942
GET012	303	0.961	0.879	1.006	0.975	1.086
GET012	323	0.972	0.910	1.004	0.984	1.061
GET012	342	0.982	0.940	1.003	0.991	1.038
GET012	361	0.991	0.970	1.001	0.996	1.018
GET012	380	1.000	1.000	1.000	1.000	1.000
GET012	399	1.009	1.032	0.999	1.004	0.984
GET012	418	1.016	1.061	0.998	1.009	0.970
GET012	437	1.023	1.090	0.997	1.013	0.958
GET012	487	1.035	1.162	0.994	1.025	0.929

Table 18. Correction factors for variation in airflow (continued)

Model	Entering CFM	Cooling Capacity	Sensible Capacity	Cooling Input Watts	Heating Capacity	Heating Input Watts
GET015	432	0.961	0.865	1.010	0.975	1.082
GET015	459	0.972	0.899	1.007	0.982	1.057
GET015	486	0.982	0.933	1.006	0.989	1.036
GET015	513	0.990	0.968	1.003	0.995	1.017
GET015	540	1.000	1.000	1.000	1.000	1.000
GET015	567	1.008	1.034	0.997	1.005	0.984
GET015	594	1.015	1.067	0.995	1.009	0.971
GET015	621	1.022	1.098	0.993	1.013	0.958
GET015	648	1.029	1.125	0.991	1.017	0.947
GET018	501	0.954	0.866	1.015	0.994	1.074
GET018	553	0.973	0.907	1.003	0.995	1.061
GET018	585	0.983	0.939	1.002	0.997	1.038
GET018	618	0.992	0.970	1.001	0.998	1.018
GET018	650	1.000	1.000	1.000	1.000	1.000
GET018	683	1.008	1.030	0.999	1.002	0.985
GET018	715	1.015	1.060	0.998	1.001	0.969
GET018	748	1.022	1.087	0.997	1.003	0.956
GET018	780	1.028	1.117	0.996	1.002	0.944
GET024	656	0.962	0.877	1.003	0.974	1.079
GET024	697	0.973	0.910	1.002	0.981	1.055
GET024	738	0.983	0.940	1.000	0.988	1.034
GET024	779	0.992	0.970	1.001	0.995	1.016
GET024	820	1.000	1.000	1.000	1.000	1.000
GET024	861	1.008	1.029	0.999	1.005	0.985
GET024	902	1.014	1.058	0.998	1.010	0.972
GET024	943	1.022	1.088	0.997	1.014	0.961
GET024	984	1.028	1.117	0.996	1.018	0.950
GET036	936	0.957	0.876	1.002	0.974	1.077
GET036	995	0.969	0.907	1.001	0.981	1.052
GET036	1053	0.980	0.939	1.001	0.989	1.033
GET036	1112	0.990	0.970	1.000	0.994	1.015
GET036	1170	1.000	1.000	1.000	1.000	1.000
GET036	1229	1.009	1.032	1.000	1.005	0.987
GET036	1287	1.017	1.062	0.999	1.010	0.974
GET036	1346	1.024	1.090	0.999	1.014	0.963
GET036	1404	1.033	1.121	0.999	1.018	0.953



Unit Fan Performance

Table 19. PSC blower motor external static pressure without return air door (RAD) with filter

Model	External Static Pressure (in. of wg)															
	Speed Tap	Ducted Unit ^(a)	CFM		0		0.05		0.10		0.15		0.20		0.25	
			Max	Min	CFM	KW	CFM	KW	CFM	KW	CFM	KW	CFM	KW	CFM	KW
GET009	High	Yes	408	-	421	0.108	388	0.107	354	0.106	320	0.104	283	0.103	244	0.102
	Low	Yes	-	-	355	0.073	332	0.072	307	0.070	278	0.068	245	0.067	-	-
	High	No	-	-	357	0.073	333	0.071	309	0.070	282	0.069	253	0.067	-	-
	Low	No	-	272	307	0.061	297	0.060	280	0.059	258	0.058	-	-	-	-
GET012	High	Yes	453	-	453	0.140	433	0.137	412	0.134	390	0.130	367	0.127	342	0.124
	Low	Yes	-	-	401	0.112	383	0.109	362	0.106	340	0.103	318	0.100	295	0.097
	High	No	-	-	418	0.125	400	0.122	379	0.120	356	0.117	332	0.113	309	0.110
	Low	No	-	304	345	0.097	331	0.095	313	0.092	292	0.090	-	-	-	-
GET015	High	Yes	648	-	-	-	-	-	652	0.191	634	0.187	616	0.183	598	0.179
	Low	Yes	-	-	560	0.155	539	0.153	523	0.152	511	0.149	499	0.146	487	0.143
	High	No	-	-	553	0.169	538	0.167	524	0.165	510	0.162	496	0.159	481	0.155
	Low	No	-	432	445	0.135	433	0.135	422	0.134	-	-	-	-	-	-
GET018	High	Yes	780	-	-	-	-	-	-	-	-	-	-	-	-	-
	Low	Yes	-	-	665	0.253	644	0.249	625	0.246	608	0.242	592	0.237	575	0.232
	High	No	-	-	696	0.361	675	0.354	654	0.348	632	0.342	610	0.336	588	0.330
	Low	No	-	520	544	0.271	526	0.266	506	0.262	-	-	-	-	-	-
GET024	High	Yes	984	-	-	-	-	-	-	-	-	-	-	-	988	0.402
	Low	Yes	-	-	908	0.344	895	0.335	876	0.327	854	0.318	829	0.310	803	0.301
	High	No	-	-	850	0.317	827	0.310	806	0.303	787	0.297	768	0.291	750	0.286
	Low	No	-	656	799	0.292	781	0.286	764	0.280	746	0.275	727	0.269	709	0.264
GET036	High	Yes	1404	-	-	-	-	-	-	-	-	-	-	-	-	-
	Low	Yes	-	-	1303	0.651	1293	0.638	1282	0.625	1270	0.614	1256	0.603	1240	0.592
	High	No	-	-	1330	0.642	1304	0.630	1277	0.618	1248	0.606	1219	0.593	1188	0.581
	Low	No	-	936	1059	0.523	1051	0.516	1042	0.510	1033	0.503	1022	0.496	1011	0.488
Model	External Static Pressure (in. of wg)															
	Speed Tap	Ducted Unit ^(a)	CFM		0.30		0.35		0.40		0.45		0.50		0.55	
			Max	Min	CFM	KW	CFM	KW	CFM	KW	CFM	KW	CFM	KW	CFM	KW
GET012	High	Yes	453	-	316	0.121	288	0.118	-	-	-	-	-	-	-	-
	Low	Yes	-	-	-	-	-	-	-	-	-	-	-	-	-	-
	High	No	-	-	286	0.107	-	-	-	-	-	-	-	-	-	-
	Low	No	-	304	-	-	-	-	-	-	-	-	-	-	-	-
GET015	High	Yes	648	-	579	0.175	558	0.170	535	0.165	510	0.160	480	0.154	445	0.148
	Low	Yes	-	-	472	0.139	455	0.135	433	0.130	405	0.125	-	-	-	-
	High	No	-	-	464	0.151	444	0.147	421	0.142	-	-	-	-	-	-
	Low	No	-	432	-	-	-	-	-	-	-	-	-	-	-	-
GET018	High	Yes	780	-	-	-	785	0.330	758	0.323	729	0.317	697	0.311	661	0.305
	Low	Yes	-	-	556	0.227	537	0.221	517	0.215	-	-	-	-	-	-
	High	No	-	-	566	0.324	544	0.318	521	0.312	497	0.305	-	-	-	-
	Low	No	-	520	-	-	-	-	-	-	-	-	-	-	-	-

Unit Fan Performance

Table 19. PSC blower motor external static pressure without return air door (RAD) with filter (continued)

Model		External Static Pressure (in. of wg)														
Speed Tap	Ducted Unit ^(a)	CFM		0.30		0.35		0.40		0.45		0.50		0.55		
		Max	Min	CFM	KW	CFM	KW	CFM	KW	CFM	KW	CFM	KW	CFM	KW	
GET024	High	Yes	984	-	955	0.392	920	0.382	884	0.371	847	0.359	810	0.348	774	0.336
	Low	Yes	-	-	778	0.293	754	0.285	732	0.277	712	0.268	693	0.260	675	0.251
	High	No	-	-	730	0.280	710	0.274	689	0.267	666	0.260	642	0.251	-	-
	Low	No	-	656	690	0.258	671	0.252	651	0.246	-	-	-	-	-	-
GET036	High	Yes	1404	-	1420	0.686	1396	0.674	1371	0.662	1346	0.650	1320	0.638	1293	0.625
	Low	Yes	-	-	1222	0.582	1202	0.572	1181	0.562	1160	0.553	1138	0.543	1117	0.533
	High	No	-	-	1155	0.568	1122	0.555	1086	0.542	1048	0.528	1007	0.515	965	0.501
	Low	No	-	936	998	0.480	984	0.472	967	0.464	949	0.454	927	0.444	-	-
Model		External Static Pressure (in. of wg)														
Speed Tap	Ducted Unit ^(a)	CFM		0.60		0.65		0.70		0.75		0.80		0.85		
		Max	Min	CFM	KW	CFM	KW	CFM	KW	CFM	KW	CFM	KW	CFM	KW	
GET015	High	Yes	648	-	404	0.141	-	-	-	-	-	-	-	-	-	-
	Low	Yes	-	-	-	-	-	-	-	-	-	-	-	-	-	-
	High	No	-	-	-	-	-	-	-	-	-	-	-	-	-	-
	Low	No	-	432	-	-	-	-	-	-	-	-	-	-	-	-
GET018	High	Yes	780	-	620	0.300	573	0.295	518	0.291	-	-	-	-	-	-
	Low	Yes	-	-	-	-	-	-	-	-	-	-	-	-	-	-
	High	No	-	-	-	-	-	-	-	-	-	-	-	-	-	-
	Low	No	-	520	-	-	-	-	-	-	-	-	-	-	-	-
GET024	High	Yes	984	-	739	0.324	706	0.312	676	0.299	649	0.287	-	-	-	-
	Low	Yes	-	-	658	0.243	641	0.234	-	-	-	-	-	-	-	-
	High	No	-	-	-	-	-	-	-	-	-	-	-	-	-	-
	Low	No	-	656	-	-	-	-	-	-	-	-	-	-	-	-
GET036	High	Yes	1404	-	1265	0.613	1236	0.601	1206	0.588	1175	0.575	1142	0.563	1107	0.550
	Low	Yes	-	-	1097	0.522	1076	0.511	1055	0.498	1031	0.486	1003	0.472	967	0.456
	High	No	-	-	919	0.487	-	-	-	-	-	-	-	-	-	-
	Low	No	-	936	-	-	-	-	-	-	-	-	-	-	-	-
Model		External Static Pressure (in. of wg)														
Speed Tap	Ducted Unit ^(a)	CFM		0.90		0.95		1.00		1.05		1.10				
		Max	Min	CFM	KW	CFM	KW	CFM	KW	CFM	KW	CFM	KW			
GET036	High	Yes	1404	-	1071	0.536	1032	0.523	991	0.509	947	0.495	900	0.481		
	Low	Yes	-	-	919	0.440	-	-	-	-	-	-	-	-		
	High	No	-	-	-	-	-	-	-	-	-	-	-	-		
	Low	No	-	936	-	-	-	-	-	-	-	-	-	-		

(a) The NO "Ducted" option is for non-ducted (free return) units. Units specified as "non-ducted" (free return) are factory wired to low-speed. Units specified as "ducted" are factory wired to high-speed.



Unit Fan Performance

Table 20. ECM Blower motor external static pressure with return air door (RAD) with filter

Model No.	Airflow Profile	External Static Pressure (in. of wg)															
		CFM	0.00 kW	0.05 kW	0.10 kW	0.15 kW	0.20 kW	0.25 kW	0.30 kW	0.35 kW	0.40 kW	0.45 kW	0.50 kW	0.55 kW	0.60 kW	0.65 kW	0.70 kW
GET009	A	374	0.025	0.037	0.050	0.062	0.075	0.087	0.098	0.110	0.121	0.133	0.144	0.037	0.165	0.176	0.176
	B	344	0.023	0.035	0.046	0.057	0.068	0.079	0.090	0.100	0.110	0.120	0.130	0.035	0.149	0.159	0.159
	C	313	0.021	0.032	0.042	0.052	0.062	0.071	0.081	0.090	0.099	0.108	0.117	0.032	0.134	0.143	0.143
	D	285	0.017	0.027	0.036	0.045	0.054	0.063	0.071	0.080	0.088	0.096	0.104	0.027	0.120	0.127	0.127
GET012	A	487	0.027	0.042	0.057	0.071	0.086	0.100	0.114	0.128	0.142	0.155	0.168	0.042	0.193	0.206	0.206
	B	442	0.025	0.038	0.052	0.065	0.077	0.090	0.103	0.115	0.127	0.139	0.151	0.038	0.173	0.184	0.184
	C	403	0.023	0.034	0.046	0.057	0.069	0.080	0.091	0.102	0.112	0.122	0.133	0.034	0.152	0.161	0.161
	D	368	0.019	0.029	0.039	0.049	0.059	0.068	0.078	0.087	0.096	0.105	0.114	0.029	0.131	0.139	0.139
GET015	A	594	0.062	0.072	0.081	0.090	0.100	0.109	0.119	0.128	0.138	0.148	0.158	0.072	0.179	0.191	0.202
	B	540	0.044	0.054	0.064	0.073	0.083	0.092	0.101	0.111	0.121	0.131	0.141	0.054	0.162	0.173	0.185
	C	486	0.032	0.042	0.051	0.060	0.069	0.079	0.088	0.097	0.106	0.116	0.126	0.042	0.146	0.157	0.168
	D	432	0.025	0.034	0.042	0.051	0.059	0.068	0.076	0.085	0.093	0.102	0.111	0.034	0.130	0.140	0.150
GET018	A	712	0.097	0.109	0.121	0.134	0.148	0.163	0.178	0.193	0.208	0.223	0.239	0.109	0.130	0.140	0.150
	B	648	0.077	0.087	0.098	0.110	0.123	0.136	0.150	0.163	0.177	0.191	0.205	0.087	0.268	0.282	0.282
	C	584	0.056	0.066	0.076	0.087	0.099	0.111	0.123	0.135	0.148	0.160	0.172	0.066	0.230	0.242	0.242
	D	522	0.039	0.048	0.058	0.069	0.080	0.091	0.102	0.114	0.125	0.136	0.147	0.048	0.194	0.204	0.204
GET024	A	903	0.100	0.118	0.135	0.152	0.168	0.185	0.201	0.216	0.232	0.247	0.261	0.118	0.290	0.303	0.303
	B	827	0.081	0.096	0.111	0.125	0.140	0.154	0.168	0.182	0.196	0.209	0.222	0.096	0.248	0.261	0.261
	C	746	0.060	0.073	0.085	0.098	0.110	0.123	0.136	0.148	0.161	0.173	0.185	0.073	0.210	0.222	0.222
	D	659	0.041	0.052	0.063	0.074	0.085	0.097	0.109	0.121	0.133	0.145	0.157	0.052	0.182	0.194	0.194
GET036	A	1293	0.285	0.306	0.328	0.349	0.370	0.392	0.413	0.433	0.454	0.475	0.496	0.306	0.537	0.557	0.557
	B	1178	0.214	0.233	0.253	0.272	0.292	0.311	0.330	0.349	0.369	0.388	0.406	0.233	0.444	0.463	0.463
	C	1063	0.158	0.175	0.193	0.210	0.227	0.245	0.262	0.279	0.296	0.313	0.331	0.175	0.365	0.382	0.382
	D	950	0.117	0.133	0.148	0.163	0.178	0.193	0.208	0.223	0.238	0.254	0.269	0.133	0.299	0.314	0.314

Note: The ECM is programmed for constant CFM. The CFM is factory set on Profile B. The ECM reduces the airflow to 80% in fan only mode for additional energy savings.

Table 21. Fan performance for standard ECM with return air door (RAD) with filter

Model Number	Max ESP (in. wc)	Fan Motor (hp)	Profile Setting	Cooling Mode	Heating Mode	Fan Only Mode
GET009	0.7	1/3	A	374	374	299
	0.7	1/3	B	344	344	275
	0.7	1/3	C	313	313	250
	0.7	1/3	D	285	285	228
GET012	0.7	1/3	A	487	487	390
	0.7	1/3	B	442	442	354
	0.7	1/3	C	403	403	322
	0.7	1/3	D	368	368	294
GET015	0.7	1/2	A	594	594	475
	0.7	1/2	B	540	540	432
	0.7	1/2	C	486	486	389
	0.7	1/2	D	432	432	346

Table 21. Fan performance for standard ECM with return air door (RAD) with filter (continued)

Model Number	Max ESP (in. wc)	Fan Motor (hp)	Profile Setting	Cooling Mode	Heating Mode	Fan Only Mode
GET018	0.7	1/2	A	712	712	570
	0.7	1/2	B	648	648	518
	0.7	1/2	C	584	584	467
	0.7	1/2	D	522	522	418
GET024	0.7	1/2	A	903	903	722
	0.7	1/2	B	827	827	662
	0.7	1/2	C	746	746	597
	0.7	1/2	D	659	659	527
GET036	0.7	3/4	A	1293	1293	1034
	0.7	3/4	B	1178	1178	942
	0.7	3/4	C	1063	1063	850
	0.7	3/4	D	950	950	760

Notes:

1. The ECM is programmed for constant CFM. The CFM is factory set on Profile B. The ECM reduces the airflow to 80% in fan only mode for additional energy savings.
2. Fan profile settings are selected by the ECM control board DIP switch setting on units with deluxe 24 V controls.
3. For units with Symbio™ 400-B/UC400-B, the Symbio 400-B/UC400-B will vary the ECM fan speed depending on how far away the load is from set point. The minimum and maximum fan speeds are factory set. Tracer® TU is required to make modifications to the min/max fan speed settings.

Figure 4. ECM control board and dip switch setting

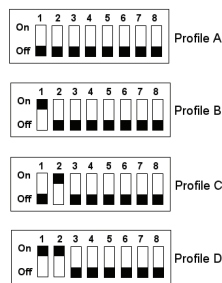
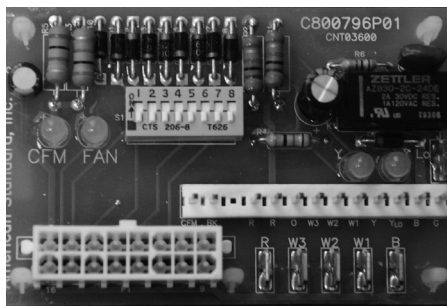

Note: ECM control board with dip switches is only on units with deluxe 24 V controls. Tracer TU is used to adjust fan speed on units with Symbio 400-B/UC400-B controls.

Table 22. Pressure drop due to return air door (RAD)

Model	CFM	DP	CFM	DP	CFM	DP
GET009	272	0.04	340	0.05	408	0.08
GET012	303	0.04	380	0.07	456	0.11
GET015	432	0.06	540	0.09	648	0.12
GET018	520	0.08	650	0.12	780	0.16
GET024	656	0.06	820	0.08	984	0.12
GET036	936	0.10	1170	0.16	1404	0.23

Note: The pressure drop across the RAD door should be included in the TOTAL ESP when determining airflow and fan motor power usage. If the door is supplied by another vendor, the pressure drop across that door must be included in the TOTAL ESP when determining airflow and fan motor power usage.

Unit Fan Performance

Table 23. Antifreeze correction factors

Methanol Concentration by Volume						
Item	0%	10%	20%	30%	40%	50%
Cooling Capacity	1.000	0.998	0.996	0.995	0.993	0.992
Heating Capacity	1.000	0.995	0.990	0.985	0.979	0.974
Pressure Drop	1.000	1.023	1.057	1.091	1.122	1.160
Ethylene Glycol Concentration by Volume						
Item	0%	10%	20%	30%	40%	50%
Cooling Capacity	1.000	0.996	0.991	0.987	0.983	0.979
Heating Capacity	1.000	0.993	0.985	0.977	0.969	0.961
Pressure Drop	1.000	1.024	1.068	1.124	1.188	1.263
Propylene Glycol Concentration by Volume						
Item	0%	10%	20%	30%	40%	50%
Cooling Capacity	1.000	0.993	0.987	0.980	0.974	0.968
Heating Capacity	1.000	0.986	0.973	0.960	0.948	0.935
Pressure Drop	1.000	1.040	1.098	1.174	1.273	1.405
NaCl Concentration by Volume						
Item	0%	10%	20%	30%	40%	50%
Cooling Capacity	1.000	0.994	0.987	0.979	0.971	0.963
Heating Capacity	1.000	0.993	0.987	0.982	0.978	0.976
Pressure Drop	1.000	1.154	1.325	1.497	1.669	1.841

Figure 5. Cooling capacity correction factor

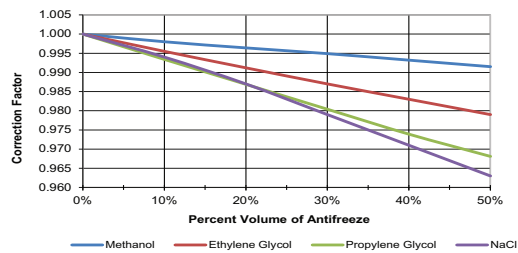

Figure 6. Heating capacity correction factor

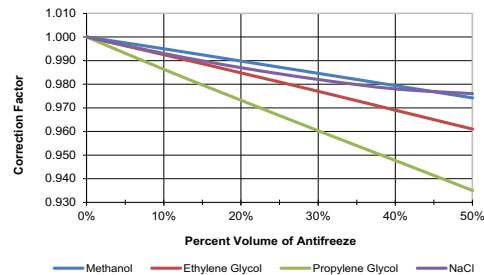
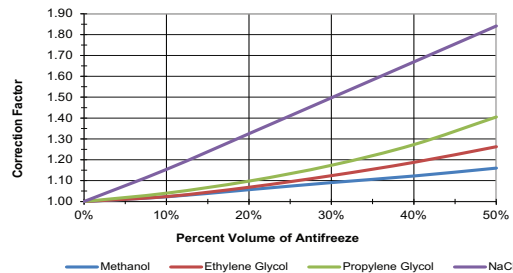

Figure 7. Water pressure drop correction factor



Example 1 (Ethylene Glycol) - The antifreeze solution is 20% by volume of Ethylene Glycol. Determine the corrected cooling capacity and waterside pressure drop for a GET009 when the EWT is 86°F and the GPM is 2.3.

From the catalog data, the cooling capacity at these conditions with 100% water is 8.3 Mbtuh, and the waterside pressure drop is 9.1 feet of head. At 20% Ethylene Glycol, the correction factor for cool capacity is 0.9912 and the pressure drop is 1.068.

The corrected cooling capacity (Mbtuh) = $8.50 \times 0.9912 = 8.43$. The corrected water side pressure drop (Ft. head) = $9.1 \times 1.068 = 9.72$.

Example 2 (Propylene Glycol) - The antifreeze solution is 30% by volume of Propylene Glycol. Determine the corrected heating capacity and waterside pressure drop for a GET009 when the EWT is 45°F and the GPM is 2.3.

From the catalog data, the heating capacity at these conditions with 100% water is 8.3 Mbtuh, and the waterside pressure drop is 11.1 feet of head. At 30% Propylene Glycol, the correction factor for heat capacity is 0.9603 and the pressure drop is 1.174.

The corrected heating capacity (Mbtuh) = $8.3 \times 0.9603 = 7.97$. The corrected water side pressure drop (Ft. head) = $11.1 \times 1.174 = 13.03$.

Controls

Figure 8. Deluxe 24 V control board

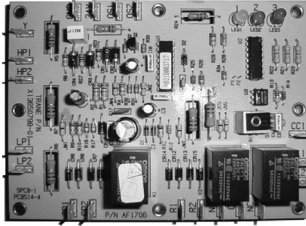

The 24 V deluxe design is a microprocessor-based control board conveniently located in the control box. The board is unique to Trane water-source products and is designed to control the unit as well as provide outputs for unit status and fault detection.

The board is factory wired to a terminal strip to provide all necessary terminals for field connections.

Deluxe 24 V Electronic Controls

- Anti-short cycle compressor protection
- Brown out protection
- Compressor contactor
- Compressor lock-out relay
- Condensate overflow
- Freeze protection
- High pressure switch
- Low pressure switch
- Low pressure time delay
- Multi-speed fan motor
- Random start delay
- Reversing valve coil
- Soft lockout mode

Deluxe 24 V Features

Anti-short Cycle Timer

The anti-short cycle timer provides a three minutes time delay between compressor stop and compressor restart. Once thermostat is enabled, an automatic 3 minutes delay is provided for compressor protection.

Brown-out Protection

The brown-out protection function measures the input voltage to the controller and halts the compressor operation. Once a brown-out situation has occurred, the anti-short cycle timer will become energized. The general fault contact will not be affected by this condition. The voltage will continue to be monitored until the voltage increases. The compressors will be enabled at this time if all start-up time delays have expired, and all safeties have been satisfied.

Compressor Disable

The compressor disable relay provides a temporary disable in compressor operation. The signal would be provided from a water loop controller in the system. It would disable the compressor because of low water flow, peak limiting or if the unit goes into an unoccupied state. Once the compressor has been disabled, the anti-short cycle time period will begin. Once the compressor disable signal is no longer present, and all safeties are satisfied, the control will allow the compressor to restart.

Diagnostics

Three LEDs (light emitting diodes) are provided for indicating the operating mode of the controller. See the unit IOM for diagnostics or troubleshooting through the use of the LEDs.

Random Start

The random start relay provides a time delay start-up of the compressor when cycling in the occupied mode. A new start delay time between 3 and 10 seconds is applied each time power is enabled to the unit.

Safety Control

The deluxe controller receives separate input signals from the refrigerant high pressure switch, low suction pressure switch, freezestat and condensate overflow.

In a high pressure situation, the compressor contactor is de-energized, which suspends compressor operation. The control will go into soft lockout mode initializing a three minutes time delay and a random start of 3 to 10 seconds time delays. Once these delays have expired, the unit will be allowed to run. If a high pressure situation occurs within one hour of the first situation, the control will be placed into a manual lockout mode, halting compressor operation, and initiating the general alarm.

In a low temperature situation, the low pressure switch will transition open after the compressor starts. If the switch is open for 45 seconds during compressor start, the unit will go into soft lockout mode initializing a three minutes time delay and a random start of 3 to 10 seconds time delays. Once these delays have expired, the unit will be allowed to run. If the low pressure situation occurs again within 30 minutes, and the device is open for more than 45 seconds, the control will be placed into a manual lockout mode, halting compressor operation, and initiating the general alarm.

In a condensate overflow situation, the control will go into manual lockout mode, halting compressor operation, and initiating the general alarm.

The general alarm is initiated when the control goes into a manual lockout mode for either high pressure, low pressure, freezestat or condensate overflow conditions. The alarm can be reset at the thermostat or by cycling power to the unit.

The Symbio™ 400-B/Tracer® UC400-B controller detects the state of the high pressure or low pressure switches. When a fault is sensed by one of these switches, the corresponding message is sent to the controller to be logged into the fault log. When the circuit returns to normal, the high pressure control and low pressure control automatically resets. If a second fault is detected within a thirty-minutes time span, the unit must be manually reset.

Small Building Control

The deluxe 24 V electro-mechanical design may be applied as a stand-alone control system or as a multi-unit installation system. With a stand-alone design, units run independently of one another with an electronic digital thermostat.

Symbio™ 400-B/Tracer® UC400-B

The Symbio 400-B/UC400-B is a multi-purpose, programmable (or application-specific) that provides direct-digital zone temperature control. This controller can operate as a stand-alone device or as part of a building automation system (BAS). Communication between the controller and a BAS occurs on an open standard with inter-operable protocols used in Building Automation and Control Networks (BACnet®). Programming is done by means of the Tracer® TU service tool.

Note: For more information, please reference BAS-SVX065*-EN or BAS-SVX092*-EN.

Symbio 400-B/Tracer UC400-B Functions Include:

Building Control Advantages

The Symbio 400-B/UC400-B controllers have the ability to share information with one or several units on the same communication link.

An advantage of installing a Symbio 400-B/UC400-B is its capability to work with other BACnet[®] controllers. This provides greater flexibility to the building owner, as well as greater flexibility in design.

Integrating the Symbio 400-B/UC400-B on water-source equipment, and tying it to a Tracer[®] SC or other BAS system provides a complete building management system. With a Building Automation system like a Tracer SC, the system can initiate an alarm on a loss of performance on equipment malfunctions; allowing problems to be handled in a timely manner before compromising comfort.

This type of application would most commonly be used for a large space(s) that may require more than one unit. In addition to this application design, Symbio 400-B/UC400-B controller provides a way for units located within the same space to share the same zone sensor to prevent units from simultaneously heating and cooling in the same space.

Compressor Operation

The compressor is cycled on and off to meet heating or cooling zone demands. Units use the unit capacity and pulse width modulation (PWM) logic along with minimum on/off timers to determine the operation of the compressor. The compressor is controlled ON for longer periods as capacity increases and shorter periods as capacity decreases.

Condensate Overflow

When condensate reaches the trip point, a condensate overflow signal generates a diagnostic which disables the fan, unit water valves (if present), and compressor. The unit will remain in a halted state until the condensation returns to a normal level. At this time, the switch in the drain pan will automatically reset. However, the controller's condensate overflow diagnostic must be manually reset to clear the diagnostic and restart the unit.

Data Sharing

The Symbio 400-B/UC400-B controller are capable of sending or receiving data (setpoints, fan request, or space temperature) to and from other controllers on the communication link. This allows multiple units to share a common space temperature sensor in both stand-alone and building automation applications.

Fan Operation

The supply air fan operates at the factory wired speed in the occupied or occupied standby mode. When switch is set to AUTO, the fan is configured for cycling ON with heating or cooling. In heat mode, the fan will run for 30 seconds beyond compressor shutdown in both occupied and unoccupied mode.

Filter Maintenance Timer

The controller filter status is based on cumulative run hours of the unit fan. The controller compares the fan run time against an adjustable fan run hours limit and recommends unit maintenance as required.

High and Low Pressure Switches

The Symbio 400-B/UC400-B detects the state of the high pressure or low pressure switches. When a fault is sensed by one of these switches, the corresponding message is sent to the controller to be logged into the fault log. When the circuit returns to normal, the high pressure control and low pressure control automatically reset. If a second fault is detected within a thirty-minutes time span, the unit must be manually reset.

Random Start

To prevent all of the units in a building from energizing major loads at the same time, the controller observes a random start from 0 to 25 seconds. This timer halts the controller until the random start time expires.

Reversing Valve Operation

For cooling, the reversing valve output is energized simultaneously with the compressor. It will remain energized until the controller turns on the compressor for heating. At this time, the reversing valve moves

to a de-energized state. In the event of a power failure or controller OFF situation, the reversing valve output will default to the heating (de-energized) state.

Trane Air-Fi® Wireless Systems



Trane Air-Fi wireless systems provides significant advantages to better meet customer by providing a lower initial cost; ease of installation for reduced risk; increased reliability and flexibility for easier problem solving; and fewer maintenance issues for worry-free operation and cost savings over the life of the system. Trane Air-Fi wireless systems helps save time and money, with industry-leading technology and performance.

Air-Fi Wireless Communications Interface (WCI)

The Air-Fi Wireless Communications Interface (WCI) enables wireless communications between system controls, unit controls, and wireless sensors for Trane control products that use the BACnet® protocol. The WCI replaces the need for communications wire in all system applications.

The universal model is available on the WSHP vertical stack. It installs the same as a wired zone sensor in indoor applications.

Air-Fi Wireless Communications Sensor (WCS)

The Air-Fi Wireless Communications Sensor (WCS) is compatible with any Trane controller that uses a WCI. The WCS provides the same functions as many currently available Trane wired sensors. No further software or hardware is necessary for site evaluation, installation, or maintenance. Space temperature is standard on all models. (A service tool cannot be connected to a Trane® wireless sensor.)

Three WCS models are available:

- Digital display (WCS-SD) model
- Base (WCS-SB) model has no exposed display or user interface
- 2% relative humidity sensor module (WCS-SH), which can be field installed inside either the WCS-SD or WCS-SB.

In most applications, one WCS-SD or WCS-SB sensor will be used per WCI acting as a router. However, up to 6 WCS-SD or WCS-SB sensors can be associated to a single equipment controller or BCI.

Compatibility with Previous Generation Wireless Zone Products

Our previous line of wireless zone sensors (WZS, WTS, and WDS) are not compatible with the Air-Fi Wireless Communications Interface (WCI).

The new Air-Fi Wireless Communications Sensor (WCS) are compatible with old WCIs that have updated firmware.

Wired Zone Sensors

Wired zone sensors can be used with Air-Fi wireless systems.

Thermostats and Zone Sensors

Table 24. Thermostat selection for use with the deluxe controller







Thermostat	Part Number	Description
	TCONT824AS52D*	<p>The XL 824 provides an intuitive interface and powerful features incorporated into the compact design of the color touch-screen control represent the latest in climate control technology for residential applications.</p> <ul style="list-style-type: none"> • 3 Heat/2 Cool • Built-in Nexia Bridge, the hub for the Nexia system • 4.3-inch color touchscreen • Create up to six daily heating and cooling schedules • Indoor relative humidity display • Upgradable software Wi-Fi or Ethernet connection • 5-day weather forecast and weather radar
	X13511536010	3 Heat/2 Cool, non-programmable commercial thermostat for conventional air conditioners and heat pumps that are configured with or without auxiliary heat.
	X13511537010	3 Heat/2 Cool, programmable commercial thermostat for conventional (rooftop) air conditioners and heat pumps that are configured with or without auxiliary heat.

Table 25. Zone sensor selection for use with Symbio 400-B/UC400 controller

Sensor	Part Number	Description
	X13651467020	<p>Communication Module</p> <ul style="list-style-type: none"> • Sold in packs of 12 • Provides local RJ22 connection to Trane® service tools for easy, low cost maintenance.
	X13511529010	<p>Zone Sensor</p> <ul style="list-style-type: none"> • Symbio 400-B/UC400-B compatible • External setpoint adjustment wheel

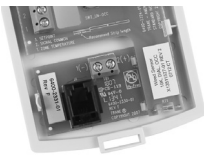

Thermostats and Zone Sensors

Table 25. Zone sensor selection for use with Symbio 400-B/UC400 controller (continued)

Sensor	Part Number	Description
	X13511527010	<p>Zone Sensor</p> <ul style="list-style-type: none"> • Symbio 400-B/UC400-B compatible • External setpoint adjustment wheel • ON and CANCEL buttons
	X13790993001	<p>Commercial Touch Screen Programmable Zone Sensor</p> <ul style="list-style-type: none"> • Supports Standby, Occupied, and Unoccupied • 7 day, 5+2 day, and 5+1+1 day • Cannot be used with BAS as sensor ties up BACnet® link. For use with factory-programmed Symbio 400-B/UC400-B. <p>Notes:</p> <ul style="list-style-type: none"> • <i>Adjusting the rotary switch on Symbio 400-B/UC400 may be required to correspond address configuration in the sensor. See the installation manual for more information.</i> • <i>Additional configuration is needed in the field to use the programmable zone sensors (to put BAS points in service on Symbio 400-B/UC400-B).</i>
	X13790992001	<p>Residential Touch Screen Programmable Zone Sensor</p> <ul style="list-style-type: none"> • Supports Awake, Away, Home, and Sleep • 7 day, 5+2 day, and 5+1+1 day • Cannot be used with BAS as sensor ties up BACnet link. For use with factory-programmed Symbio 400-B/UC400-B. <p>Notes:</p> <ul style="list-style-type: none"> • <i>Adjusting the rotary switch on Symbio 400-B/UC400 may be required to correspond address configuration in the sensor. See the installation manual for more information.</i> • <i>Additional configuration is needed in the field to use the programmable zone sensors (to put BAS points in service on Symbio 400-B/UC400-B).</i>

Thermostats and Zone Sensors

Table 26. Wireless zone sensor selection for use with Symbio 400-B/UC400-B controller

Sensor	Part Number	Description
	X1379082201	Universal Display Sensor <ul style="list-style-type: none"> • Clear and simple monitoring and control • Symbio 400-B/UC400-B Compatible
	X13790492	Wireless Zone Sensor <ul style="list-style-type: none"> • Local control • Limited occupant temp. control • Timed occupancy overrides
	X13790821	Wireless Zone Sensor <ul style="list-style-type: none"> • Simplicity • Eliminates local temperature control when higher control level is required



Electrical Data

Table 27. Electrical performance

Model No.	Motor Option	Unit Volts	Total FLA	Comp RLA (ea)	Comp LRA	Blower Motor FLA	Blower Motor HP	Minimum Circuit Ampacity	Maximum Overcurrent Protective Device
GET009	PSC Motor	208/60/1	4.3	3.7	16.0	0.60	1/20	5.23	15
		230/60/1	4.1	3.5	17.0	0.60	1/20	4.98	15
		265/60/1	3.3	2.8	13.0	0.50	1/20	4.00	15
	ECM	208/60/1	4.3	3.7	16.0	0.55	1/3	5.18	15
		230/60/1	4.1	3.5	17.0	0.55	1/3	4.93	15
		265/60/1	3.4	2.8	13.0	0.55	1/3	4.05	15
GET012	PSC Motor	208/60/1	7.0	6.3	30.0	0.70	0.13	8.58	15
		230/60/1	7.0	6.3	30.0	0.70	0.13	8.58	15
		265/60/1	5.6	5.0	23.0	0.60	0.13	6.85	15
	ECM	208/60/1	6.9	6.3	30.0	0.60	1/3	8.48	15
		230/60/1	6.9	6.3	30.0	0.60	1/3	8.48	15
		265/60/1	5.6	5.0	23.0	0.60	1/3	6.85	15
GET015	PSC Motor	208/60/1	8.6	7.9	36.0	0.70	1/8	10.58	15
		230/60/1	8.6	7.9	36.0	0.70	1/8	10.58	15
		265/60/1	7.0	6.4	30.0	0.60	1/8	8.60	15
	ECM	208/60/1	8.5	7.9	36.0	0.60	1/2	10.48	15
		230/60/1	8.5	7.9	36.0	0.60	1/2	10.48	15
		265/60/1	7.0	6.4	30.0	0.60	1/2	8.60	15
GET018	Free Discharge PSC Motor	208/60/1	10.3	9.6	42.0	0.70	1/8	12.70	20
		230/60/1	10.3	9.6	42.0	0.70	1/8	12.70	20
		265/60/1	8.3	7.7	35.0	0.60	1/8	10.23	15
	ECM	208/60/1	10.2	9.6	42.0	0.60	1/2	12.60	20
		230/60/1	10.2	9.6	42.0	0.60	1/2	12.60	20
		265/60/1	8.3	7.7	35.0	0.60	1/2	10.23	15
	Ducted PSC Motor	208/60/1	11.3	9.6	42.0	1.70	1/5	13.70	20
		230/60/1	11.3	9.6	42.0	1.70	1/5	13.70	20
		265/60/1	8.8	7.7	35.0	1.10	1/5	10.73	15
GET024	PSC Motor	208/60/1	15.7	13.5	58.3	2.20	1/3	19.08	30
		230/60/1	15.7	13.5	58.3	2.20	1/3	19.08	30
		265/60/1	10.8	9.0	54.0	1.80	1/3	13.05	20
	ECM	208/60/1	14.5	13.5	58.3	0.95	1/2	17.83	30
		230/60/1	14.5	13.5	58.3	0.95	1/2	17.83	30
		265/60/1	10.0	9.0	54.0	0.95	1/2	12.20	20
GET036	PSC Motor	208/60/1	17.7	14.1	77.0	3.60	1/2	21.23	35
		230/60/1	17.7	14.1	77.0	3.60	1/2	21.23	35
		265/60/1	15.0	12.2	72.0	2.77	1/2	18.02	30
	ECM	208/60/1	16.1	14.1	77.0	2.00	3/4	19.63	30
		230/60/1	16.1	14.1	77.0	2.00	3/4	19.63	30
		265/60/1	14.2	12.2	72.0	2.00	3/4	17.25	25

Dimensional Data

Figure 9. Unit cabinet/riser with standard base

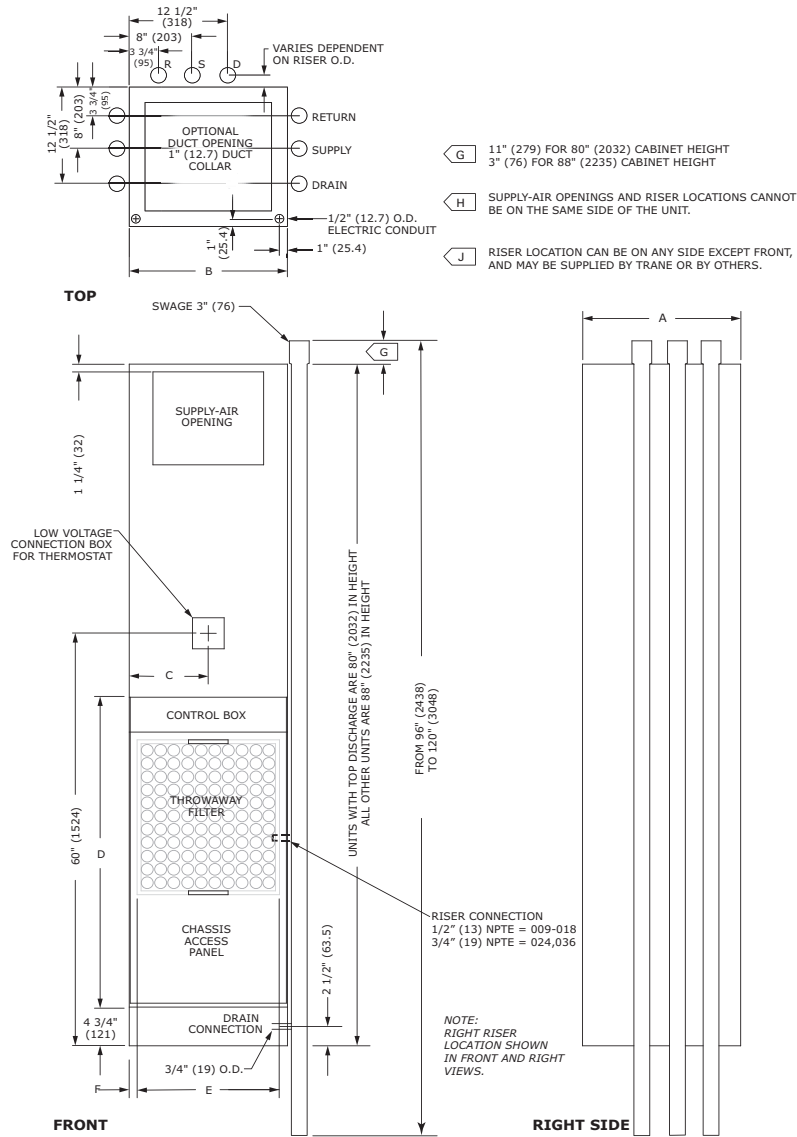

Table 28. Dimensional data - unit cabinet/riser with standard base

GET	A (inches)	B (inches)	C (inches)	D (inches)	E (inches)	F (inches)
009, 012	16 1/4	16 1/4	8 1/8	39 1/8	14 3/4	3/4
015-018	18	20	10	40 5/8	18 3/4	3/4
024-036	24	24	12	49 5/8	22 5/8	3/4

Figure 10. Unit cabinet/riser with 6-inch extended base

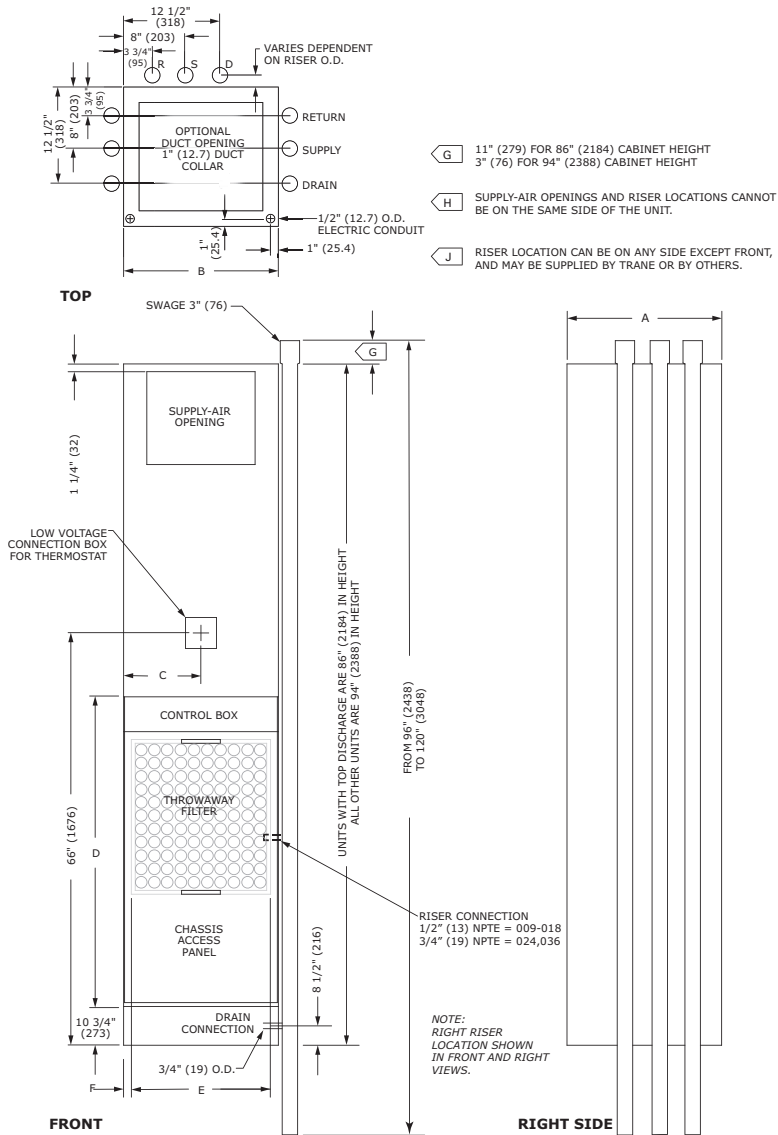

Table 29. Dimensional data - unit cabinet/riser with 6-inch extended base

GET	A (inches)	B (inches)	C (inches)	D (inches)	E (inches)	F (inches)
009, 012	16	16 1/4	8 1/8	39 1/8	14 3/4	3/4
015-018	18	20	10	40 5/8	18 3/4	3/4
024-036	24	24	12	49 5/8	22 5/8	3/4

Dimensional Data

Figure 11. Unit cabinet/riser with standard base

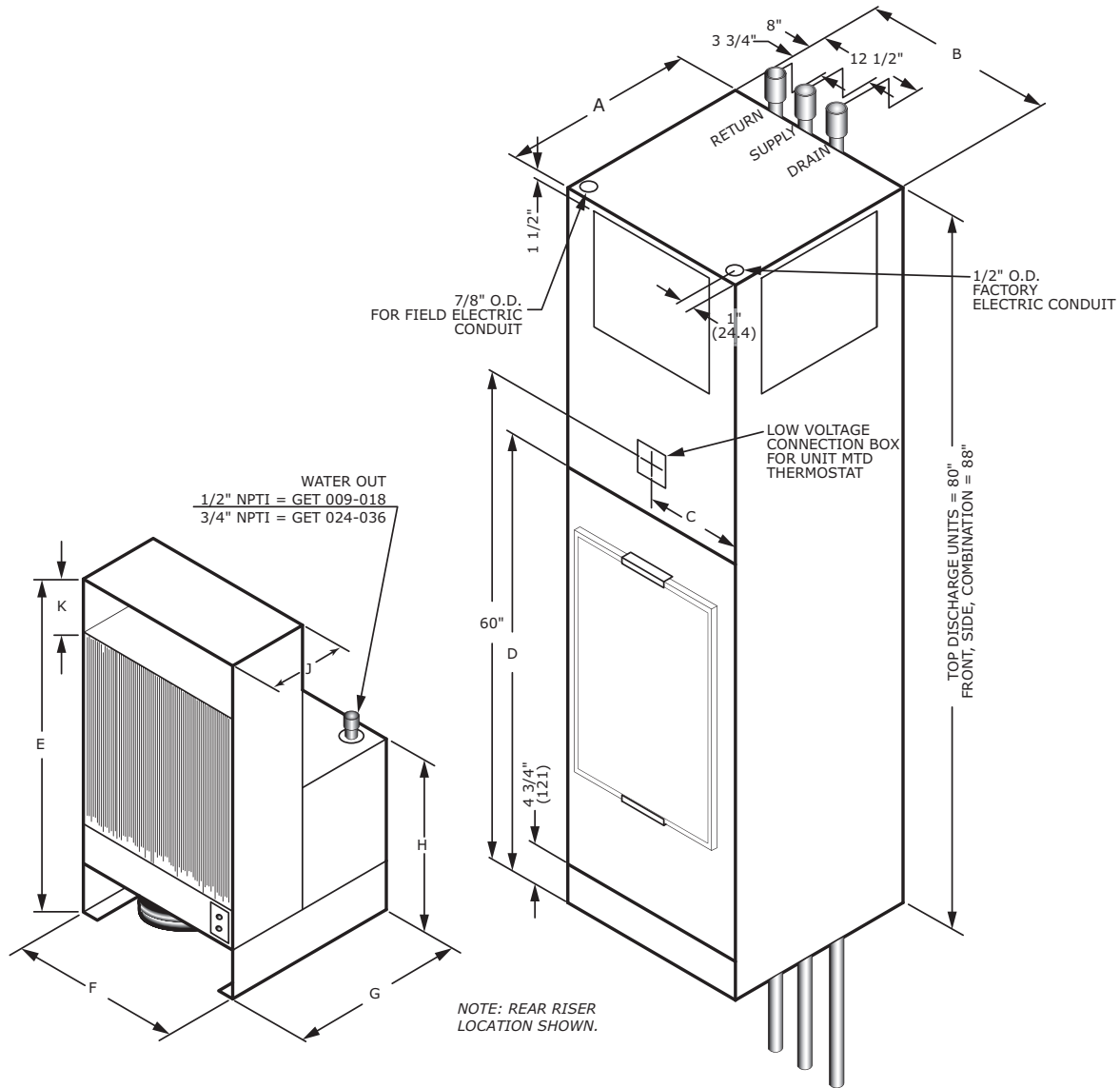
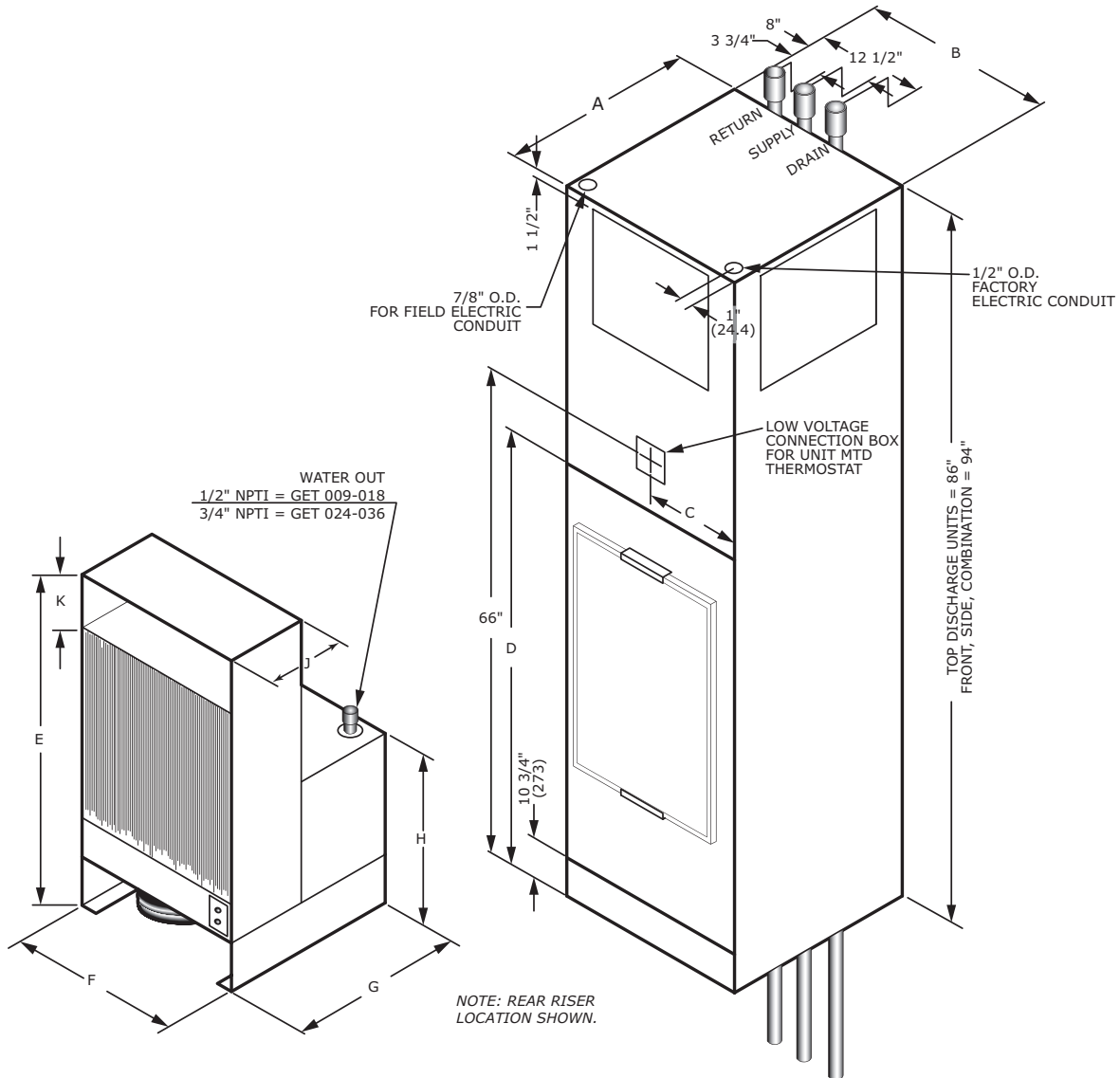

Table 30. Dimensional data - unit cabinet/riser with standard base

Unit Size	A (inches)	B (inches)	C (inches)	D (inches)	E (inches)	F (inches)	G (inches)	H (inches)	J (inches)	K (inches)
009	16 $\frac{1}{4}$	16 $\frac{1}{4}$	8 $\frac{1}{8}$	43 $\frac{7}{8}$	32 $\frac{1}{2}$	13 $\frac{5}{8}$	14	16 $\frac{7}{8}$	4 $\frac{3}{8}$	6 $\frac{1}{4}$
012	16 $\frac{1}{4}$	16 $\frac{1}{4}$	8 $\frac{1}{8}$	43 $\frac{7}{8}$	32 $\frac{1}{2}$	13 $\frac{5}{8}$	14	16 $\frac{3}{8}$	4 $\frac{3}{8}$	6 $\frac{1}{4}$
015-018	18	20	10	45 $\frac{3}{8}$	34 $\frac{8}{9}$	17 $\frac{3}{8}$	16 $\frac{1}{8}$	18 $\frac{1}{2}$	5 $\frac{1}{4}$	4 $\frac{3}{4}$
024-036	24	24	12	54 $\frac{3}{8}$	41	21 $\frac{3}{8}$	22	21 $\frac{3}{4}$	4	6

Figure 12. Unit cabinet/riser with 6-inch extended base

Table 31. Dimensional data - unit cabinet/riser with 6-inch extended base

Unit Size	A (inches)	B (inches)	C (inches)	D (inches)	E (inches)	F (inches)	G (inches)	H (inches)	J (inches)	K (inches)
009	16 $\frac{1}{4}$	16 $\frac{1}{4}$	8 1/8	49 7/8	32 $\frac{1}{2}$	13 5/8	14	16 7/8	4 3/8	6 $\frac{1}{4}$
012	16 $\frac{1}{4}$	16 $\frac{1}{4}$	8 1/8	49 7/8	32 $\frac{1}{2}$	13 5/8	14	16 3/8	4 3/8	6 $\frac{1}{4}$
015-018	18	20	10	51 3/8	34 8/9	17 3/8	16 1/8	18 $\frac{1}{2}$	5 $\frac{1}{4}$	4 $\frac{3}{4}$
024-036	24	24	12	60 3/8	41	21 3/8	22	21 $\frac{3}{4}$	4	6

Note: This page may be used in riser schedule preparation for field installed risers. Factory installed risers are only available as shown.

Modification to the factory riser may be required in the field to fit the contractor's riser schedule.

Dimensional Data

Water Flow Control

The factory installed water flow control option is hard piped to the copper or cupro-nickel water coil. The selection is available in a high or low flow option. An isolation valve and strainer are standard when the factory flow device is selected.

Two foot 1/2-inch diameter hose kit and ball valves are recommended for 009 to 018 size units. Three foot 3/4-inch diameter hose kit and ball valves are recommended for 024 to 036 size units. The hoses and ball valves are necessary and can be selected in the ordering system, or can be field provided. Hose kits are shipped separate from the chassis.

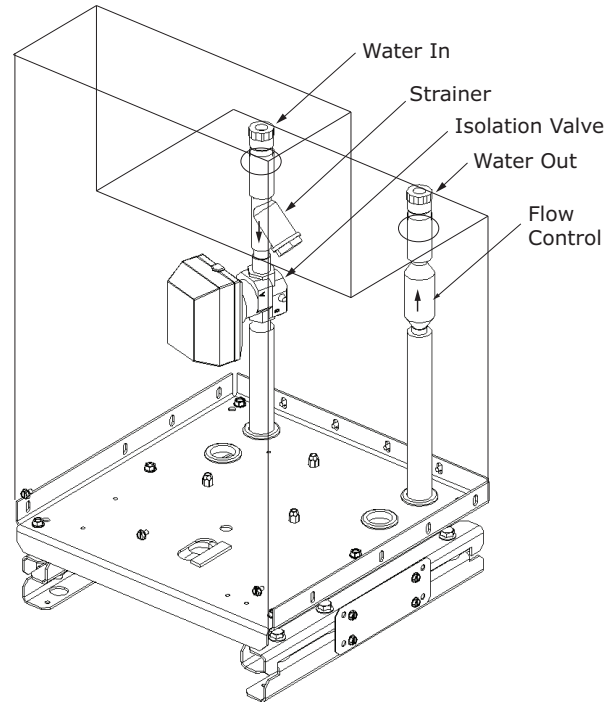
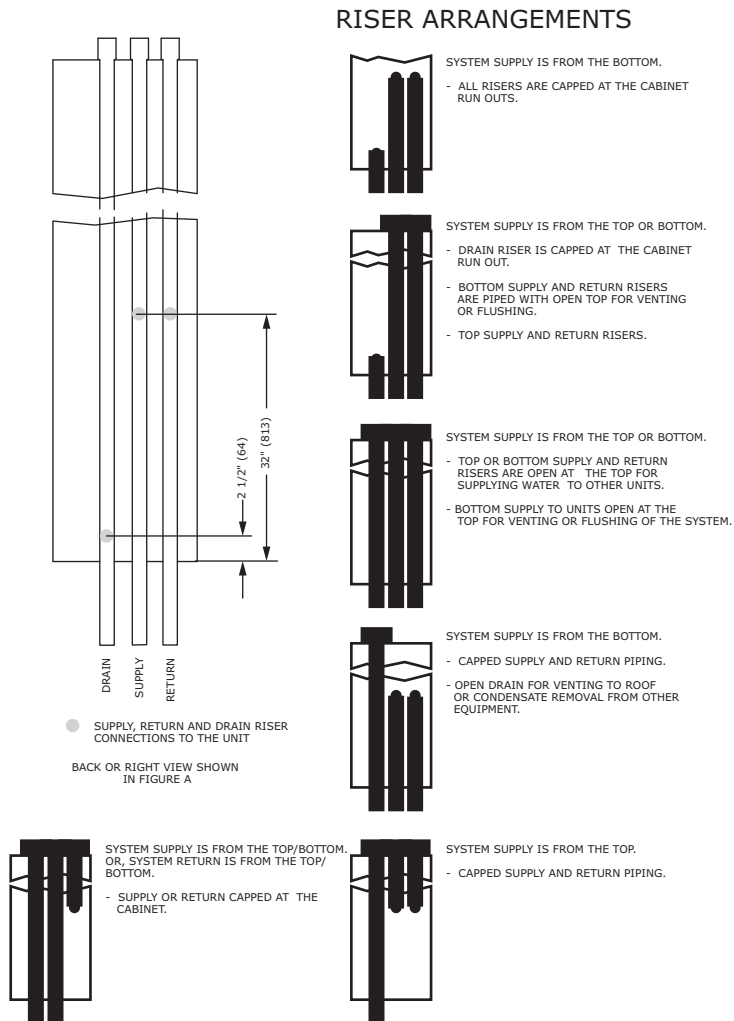

Table 32. Factory hose kit flow options

Unit Size	Low Flow Digit 9 = 3,4	High Flow Digit 9 = 5,6
009	1.5 gpm	2.0 gpm
012	2.0 gpm	2.5 gpm
015	2.5 gpm	3.5 gpm
018	3.0 gpm	4.0 gpm
024	4.0 gpm	6.0 gpm
036	6.0 gpm	8.0 gpm

Figure 13. Riser to unit connection with standard base



Riser location and appropriate hose length for ease of service is an important factor during unit installation. Recommended hose length per riser location includes:

- Sizes 009 to 018: 2 foot hose = all riser locations.
- Sizes 024 to 036: 3 foot hose = all riser locations.

Trapping the main condensate riser is recommended but not mandatory as the unit condensate line is trapped internal to the equipment.

Dimensional Data

Figure 14. Riser to unit connection with 6-inch extended base

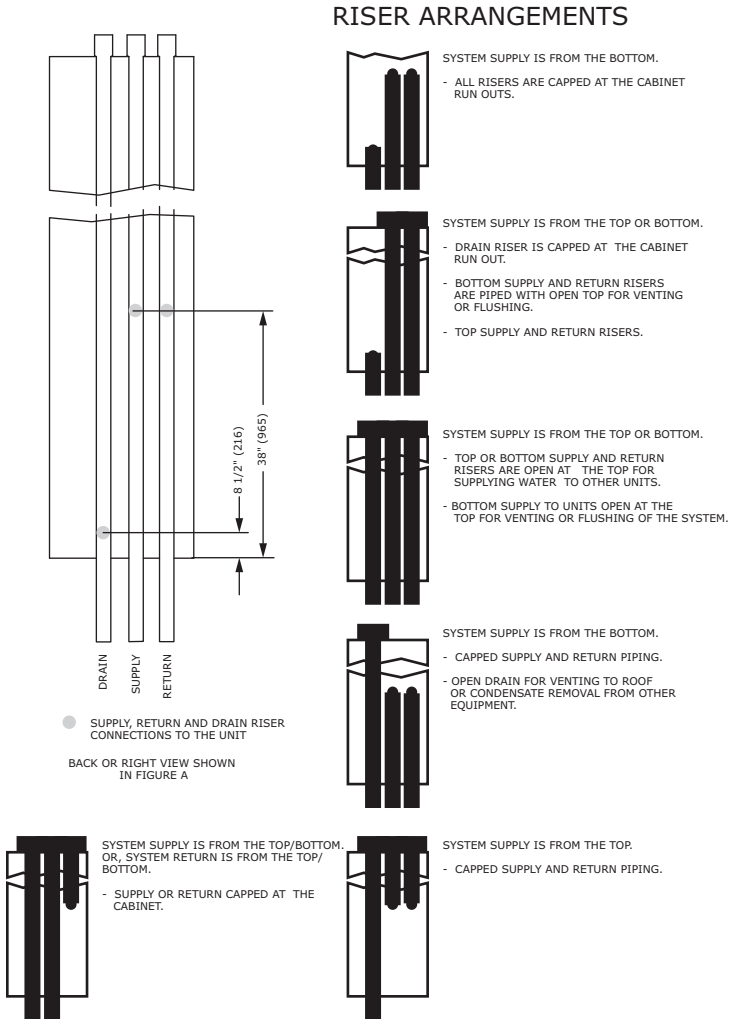

Note: This page may be used in riser schedule preparation for field installed risers. Factory installed risers are only available as shown.

Modification to the factory riser may be required in the field to fit the contractor's riser schedule.

Riser location and appropriate hose length for ease of service is an important factor during unit installation. Recommended hose length per riser location includes:

- Sizes 009 to 018: 2 foot hose = all riser locations.
- Sizes 024 to 036: 3 foot hose = all riser locations.

Trapping the main condensate riser is recommended but not mandatory as the unit condensate line is trapped internal to the equipment.

Figure 15. Supply-air arrangements

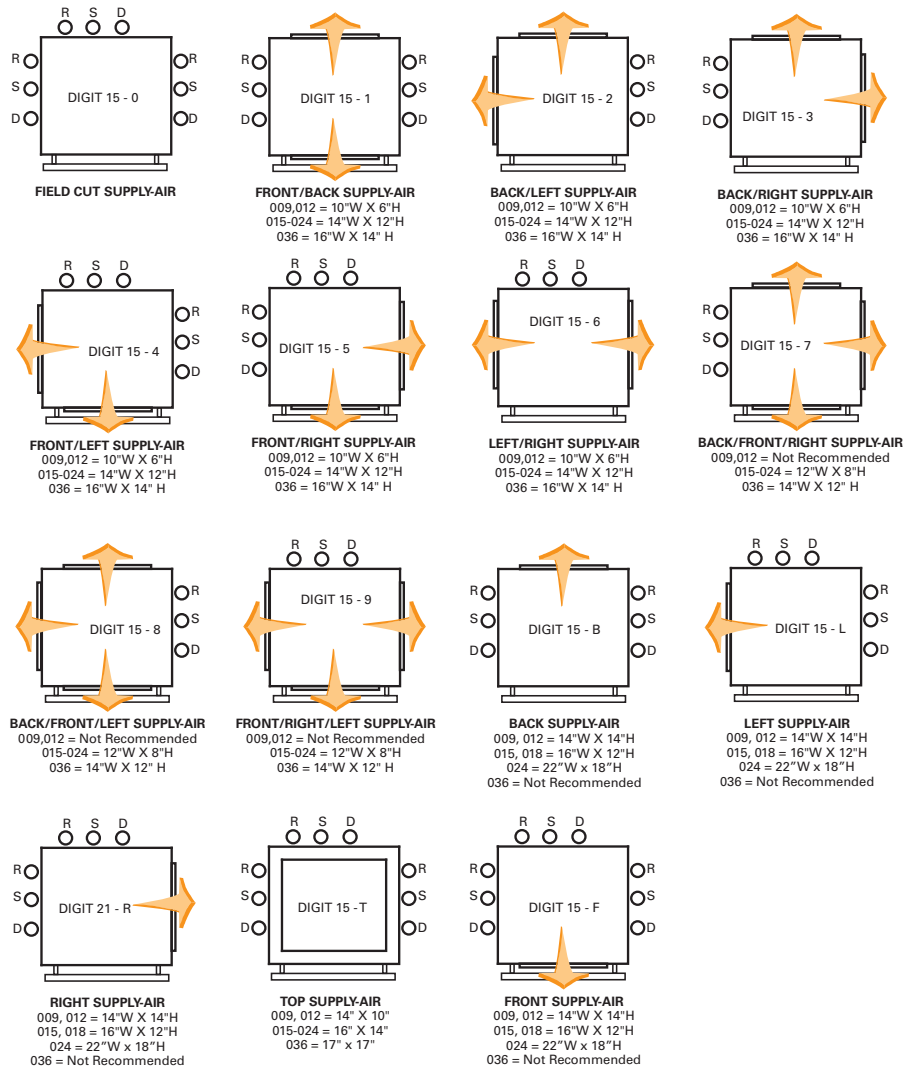
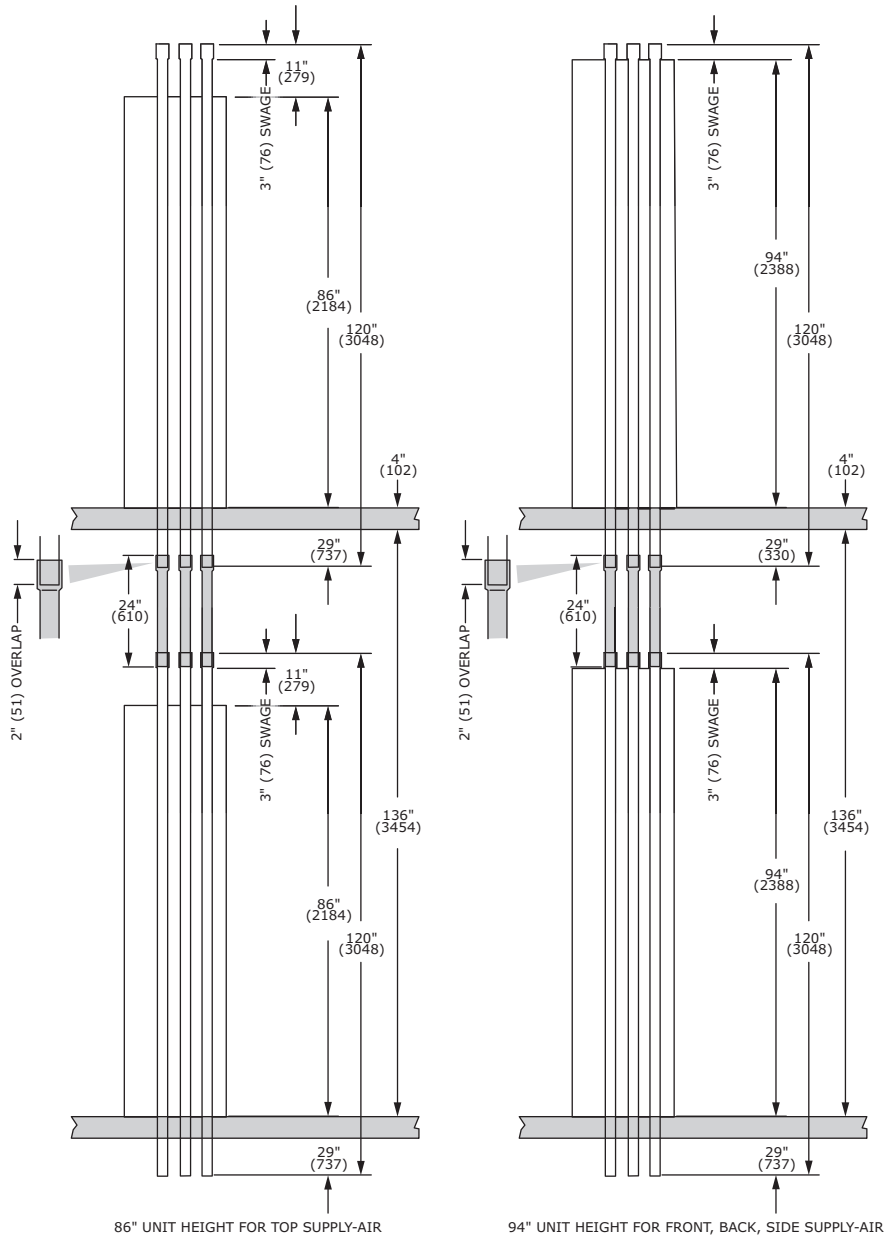

Figure 17. Riser extensions with 6-inch extended base



Riser extensions are field provided and installed.

Note: Riser expansion must be considered when calculating total riser length.

Dimensional Data

Figure 18. Hinged acoustical door with standard base

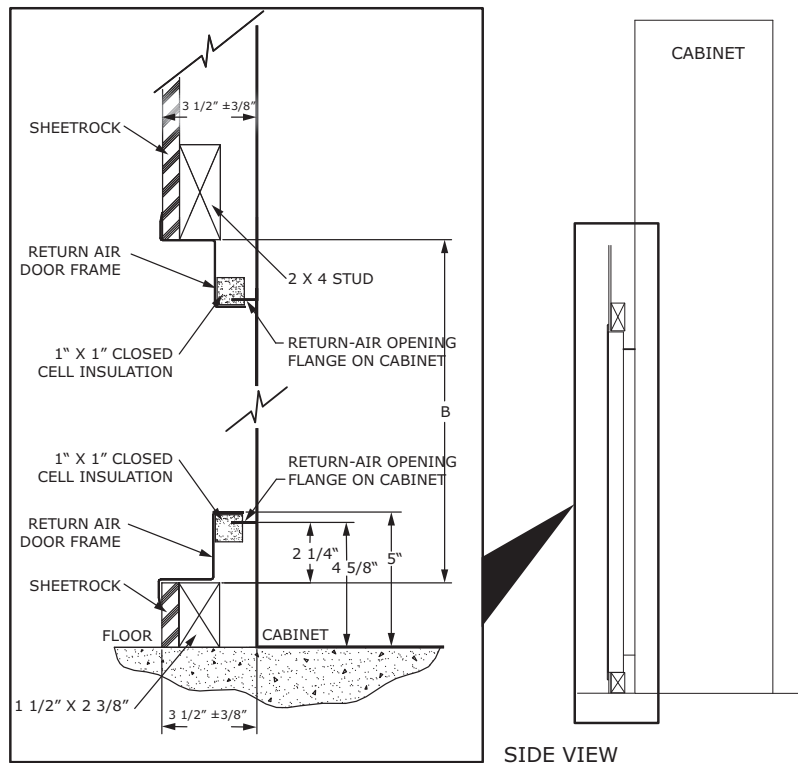
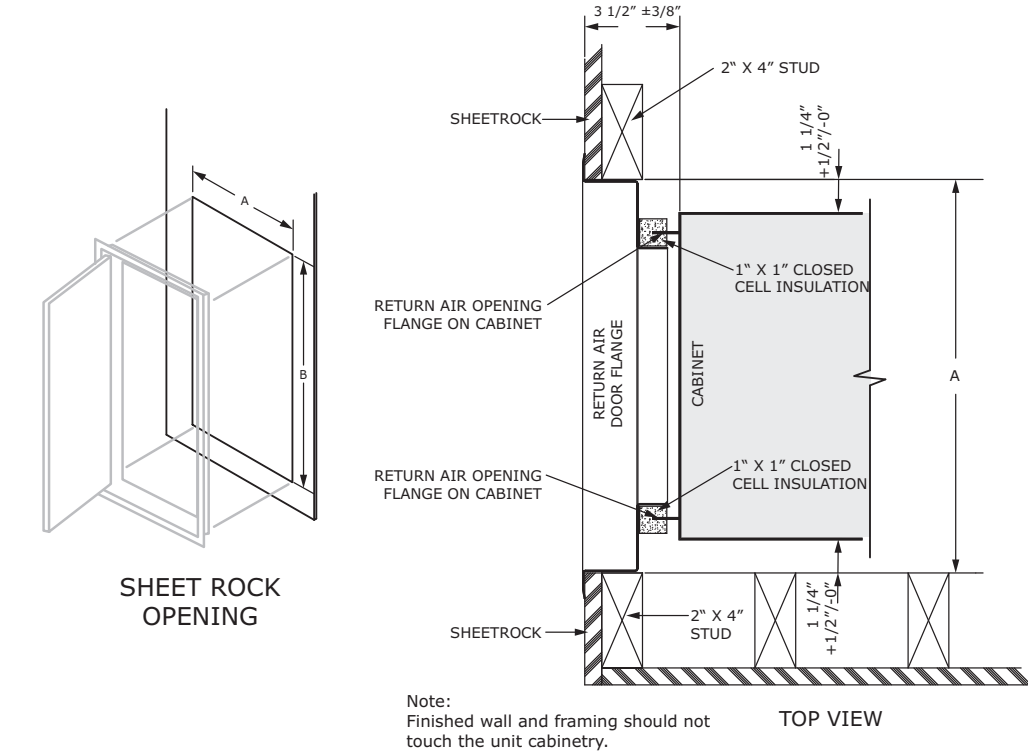
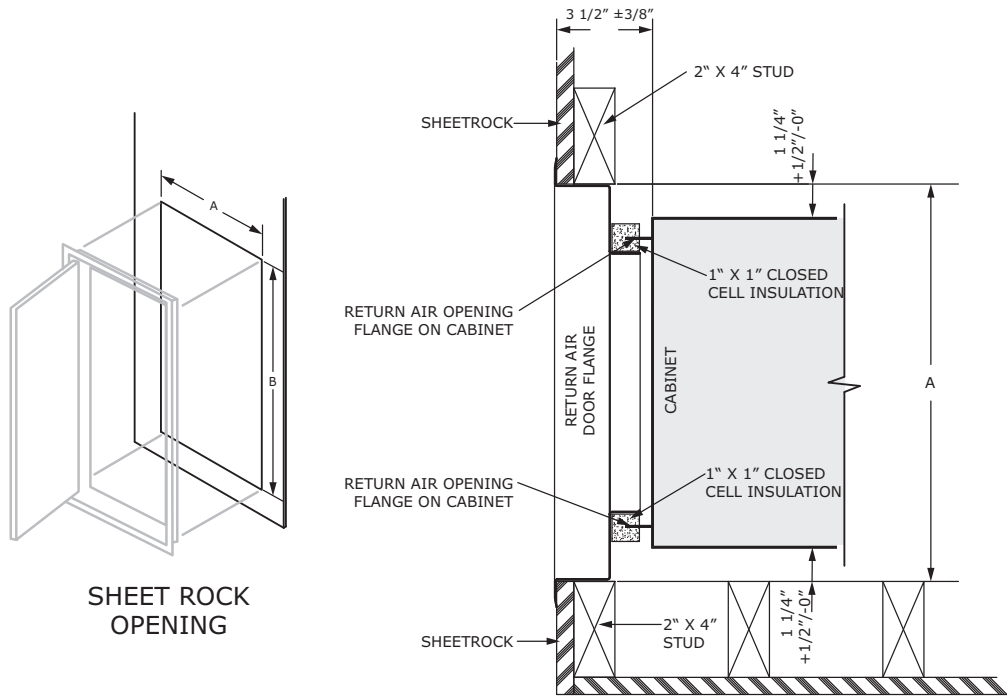
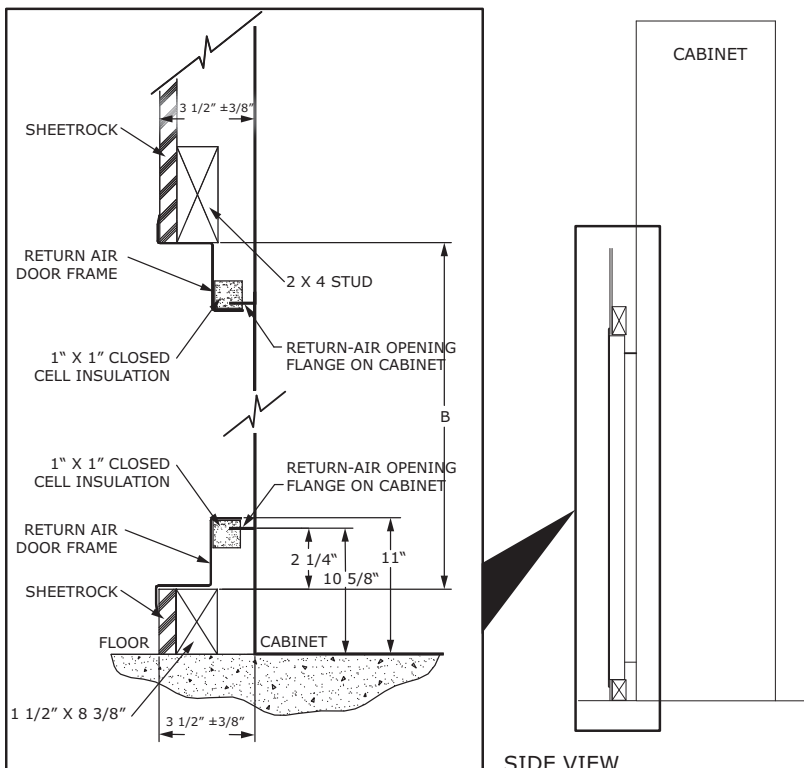

Figure 19. Hinged acoustical door with 6-inch extended base



Note:
Finished wall and framing should not touch the unit cabinetry.

TOP VIEW



SIDE VIEW

Dimensional Data

Table 33. Return air hinged acoustical door

Unit Size	A (inches)	B (inches)
009 012	19 $\frac{1}{4}$	44 $\frac{1}{8}$
015 018	23 $\frac{1}{4}$	45 $\frac{1}{4}$
024 036	27 $\frac{1}{8}$	54 $\frac{5}{8}$

Return Air (hinged) Acoustical Door

The hinged acoustical door is recessed into the wall so that the door is flush with the surface of the wall.

The opening through the wall for the door assembly must be centered with the return-air opening of the unit cabinet. For full installing instructions of the return-air acoustical door, reference WSHP-SVX10*-EN.

The dimensional data shown is based on the factory supplied return air door.

Figure 20. Single deflection grille

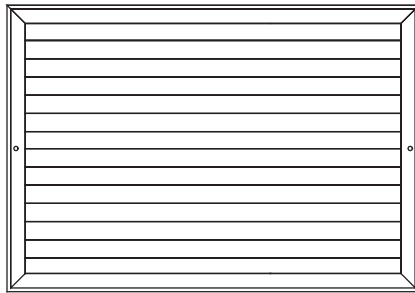

Blades are adjustable for controlling horizontal discharge path.

Figure 21. Double deflection grille

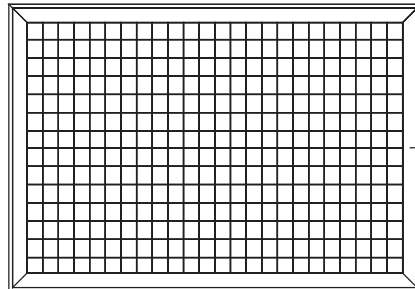

Blades are adjustable for controlling discharge path in both horizontal and vertical paths.

Table 34. Supply air opening size

GET	Single Grille 100% CFM (inches)	Two Grille 50% CFM (inches)	Three Grille 33% CFM (inches)	Top Discharge up to 100% CFM (inches)
009, 012	14Wx14H	10Wx6H	Not Recommended	14Wx10H
015, 018	16Wx12H	14Wx12H	12Wx8H	16Wx14H
024	22Wx18H	14Wx12H	12Wx8H	16Wx14H
036	Not Recommended	16Wx14H	14"Wx12"H	17Wx17H



Mechanical Specifications

General

Equipment is factory assembled, piped, internally wired, fully charged with R-410A refrigerant and oil. Units are tested at the factory.

Products are certified in accordance ANSI/AHRI/ASHRAE/ISO13256-1 Certification Program. All units have an ETL label that meets USA (UL std) and Canadian (CSA std).

All units come standard with a 5-year compressor warranty.

Air-to-Refrigerant Coil

Internally finned, 3/8-inch copper tubes mechanically bonded to a configured aluminum plate fin are standard. Coils are leak tested at the factory to ensure the pressure integrity. The coil is leak tested to 200 psig and pressure tested to 650 psig.

The refrigerant coil distributor assembly shall be of orifice style with round copper distributor tubes. The tubes are sized consistently with the capacity of the coil. Suction header is fabricated from rounded copper pipe.

A thermostatic expansion valve is factory selected and installed for a wide range of control.

Casing

The cabinet assembly is constructed of heavy-gauge galvanized steel. It houses the blower, fan and control hook-up to the unit thermostat or zone sensor. A basepan with condensate hose is included with the cabinet design. Base rails allow ease of chassis installation/removal for service or maintenance. Optional, one, two or three supply air openings shall be factory provided. Optional one or three inch flanges are provided on all free discharge openings.

The chassis is constructed of heavy-gauge galvanized steel. The chassis houses the compressor, reversing valve, water-to-refrigerant heat exchanger, air-to-refrigerant heat exchanger, thermal expansion valve, corrosive resistant condensate pan, and water inlet/outlet connections. The chassis is installed into the cabinet by sliding it in place on the locating rails within the cabinet design.

The insulation contains a flame spread rating of less than 25 and smoke density rating of less than 50 (as tested in accordance with ASTM-85). The refrigeration piping insulation is an elastomer insulation that has a UL 94-5 V rating.

Compressors

All units have a direct-drive, hermetic, rotary (unit sizes 009 to 018) or scroll (unit sizes 024 and 036) type compressor. The compressor contains rubber isolation to aid in noise reduction during compressor start/stop.

Internal thermal overload protection and compressor anti-short cycle timers are also provided. Protection against excessive discharge pressure is provided by means of a high pressure switch. Loss of charge protection is provided by a low pressure switch.

Controls

The unit control box contains all necessary devices to allow heating and cooling operation to occur from a unit mounted, plug-in thermostat or sensor. The devices are as follows:

- 24 Vac energy limiting class II 75 VA breaker type transformer.
- 24 Vac blower motor relay
- 24 Vac compressor contactor for compressor control
- A high pressure switch protects the compressor against operation at refrigerant system pressures exceeding 650 psig.
- A low pressure switch is provided that trips at 40 psig. A freeze-stat is provided - tripping at either 35° or 20°F.



Mechanical Specifications

- Factory installed wire harness is available for the deluxe and Symbio™ 400-B/UC400-B control packages.
- Power connections are made through a factory installed conduit located at the top of the unit's cabinet. An optional on/off switch is available. The conduit grants access directly to the control box.

Nameplate information is given for the application of either time-delay fuses or HACR circuit breakers for branch circuit protection from the primary source of power.

Single phase, single voltage rated equipment is designed to operate between plus or minus 10% of nameplate utilization voltage. Operation outside of this range may adversely effect the service life of the equipment.

DDC Controller (option)

The Symbio 400-B/UC400-B controllers shall utilize factory furnished and mounted DDC controls. The DDC control package shall include a 75 VA transformer, high and low pressure switch and freeze protection. An option for freeze protection is available. The controller shall provide random start delay, heating/cooling status, occupied/unoccupied mode, and filter maintenance options.

On the GET product line, the discharge air sensor and leaving water sensor are standard for the Symbio 400-B/UC400-B controls. The controllers shall be capable of a standalone application, or as applied to a full building automation installation.

The optional Air-Fi® wireless system enables wireless communications between system controls, unit controls and wireless sensors for the Symbio 400-B/UC400-B. The Wireless Controls Interface (WCI) replaces the need for communications wire in all system applications.

Drain Pan

The condensate pan is constructed of corrosive resistant material. The bottom of the drain pan is sloped in two planes to pitch the condensate towards the drain connection. Condensate is piped to a lower base pan through condensate hose for ease of chassis removal. A drain hose is factory clamped onto the drain connection for field connection.

Filters

One inch, throwaway filters are standard and factory installed. The standard filters have an average resistance of 76% and dust holding capacity of 26-grams per square foot.

Indoor Fan

The blower is a double width, double inlet (DWDI) forward curved wheel. The blower is a direct drive PSC or optional ECM fractional horsepower motor. The blower/motor assembly is designed for efficient and quiet operation. The PSC motor is multi-speed and is wired for a HIGH or LOW setting. The ECM is a constant CFM type. The motor is programmed to provide four airflow profiles and is shipped on Profile B, which is rated CFM of the unit. The motor is also factory programmed to provide 80% airflow in the fan only mode for additional energy savings. Service or maintenance to the blower/motor is easily achieved by removal of a single bracket.

Refrigerant Circuits

The refrigerant circuit contains a thermal expansion device, service pressure ports, and system safety devices factory-installed as standard.

Return-Air Hinged Acoustical Door (option)

A frame mounted acoustical door is provided to attenuate noise. The door is hinged to the wall frame, and contains magnetic latches to keep the door aesthetically in place. It is flush mounted to the wall as to not protrude into the owner space. The door allows access to the unit for ease of filter replacement.

The door is constructed from heavy-gauge formed galvanized steel and painted light white. It is available with a magnetic closure door, hex key or key lock design to fit several design applications.

Risers

Factory provided supply and return risers are Type L or Type M copper. The drain riser is Type M copper. Swages from one diameter to another are performed as specified by the engineer in the field. Diameters and length are specified by the equipment model number. The optional riser piping insulation is an elastomer with a UL 94-5V rating.

Sound Attenuation

Sound attenuation is applied as a standard feature in the product design. The enhanced reduction package includes a heavy gauge base plate, gasket and insulation around the compressor enclosure.

An optional deluxe sound reduction package is also available. It includes a heavy gauge base plate, gasket and insulation around the compressor enclosure and vibration isolation between the chassis and cabinet. A additional dampening treatment is applied around the compressor enclosure to achieve greater acoustical reductions.

Supply-Air Grilles (option)

Supply air grilles are available for air discharge from the unit. The grilles are available with either a vertical louver or a bi-directional louver. The grilles are painted light white to match the return air door.

Water-to-Refrigerant Heat Exchanger

The water-to-refrigerant heat exchanger is a co-axial coil for maximum heat transfer. The copper or optional cupro-nickel coil is deeply fluted to enhance heat transfer and minimize fouling and scaling. The coil has a working pressure of 650 psig on the refrigerant side and 400 psig on the water side.



Notes



The AHRI Certified mark indicates Trane U.S. Inc. participation in the AHRI Certification program. For verification of individual certified products, go to ahridirectory.org.

Trane - by Trane Technologies (NYSE: TT), a global climate innovator - creates comfortable, energy efficient indoor environments for commercial and residential applications. For more information, please visit trane.com or tranetechnologies.com.

Trane has a policy of continuous product and product data improvement and reserves the right to change design and specifications without notice. We are committed to using environmentally conscious print practices.