



Product Catalog

Horizontal Classroom Unit Ventilator

Model HUV

750 to 2000 CFM

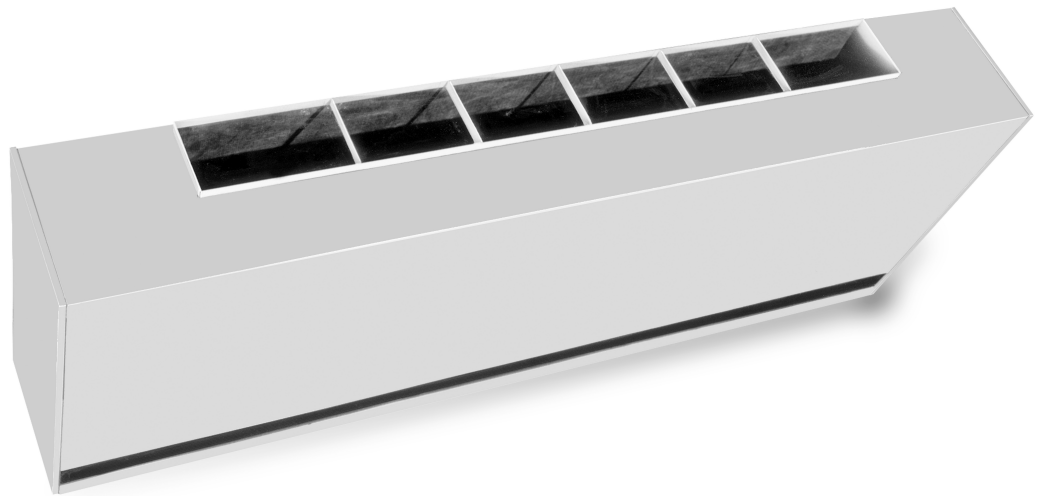



Introduction

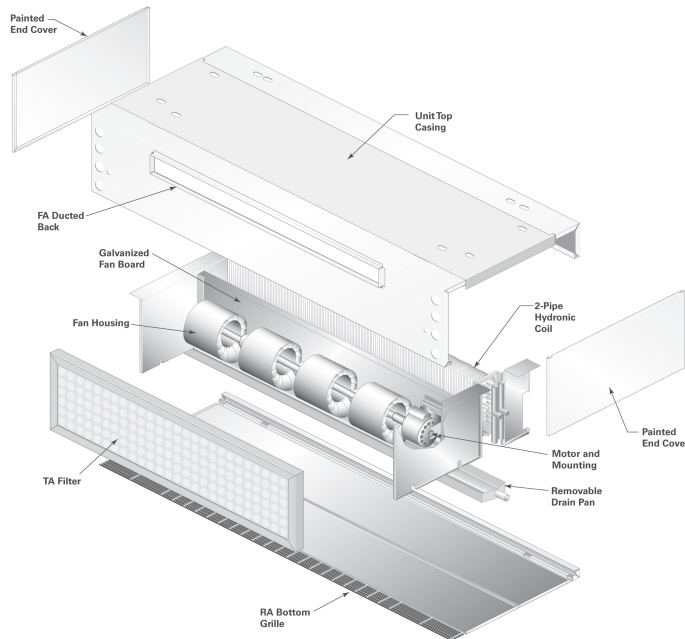

Classroom unit ventilators have been a cost-effective way to heat and cool schools for over half a century. Many schools choose classroom unit ventilators because of their ability to heat, cool and ventilate, as well as their durable cabinet design and small foot print. Because the unit ventilator is a single-space system, one unit installed in the classroom handles only that room's airflow, thus minimizing the potential for cross contamination between classrooms.

The ceiling-hung, ducted, horizontal unit ventilator may provide benefits in sound sensitive applications. The horizontal equipment can be located above the ceiling and away from direct contact with students. They may also be located in a corridor or mezzanine, then ducted into the classroom. Properly designed supply- and return-air ducts can help attenuate HVAC equipment and air noise. Locating the units outside of the classroom can also improve access and serviceability of the equipment.

Trane's commitment to providing premium quality products has led to the exclusive use of Electronically Commutated Motors (ECM) in all unit ventilator models. These brushless DC motors incorporate the latest technology for optimized energy efficiency, acoustical abatement, maintenance free and extended motor life. Each motor has a built-in microprocessor that allows for programmability, soft ramp-up, better airflow control, and serial communication.

Additionally, this is the industry's first solution that is factory-mounted, -wired, and -programmed for infinite modulation of fan speed based on space loads, using the Symbio™ 400-B. Trane unit ventilators are UL listed, and AHRI 840 certified insuring peak performance to meet today's classroom habitat.

Copyright

This document and the information in it are the property of Trane, and may not be used or reproduced in whole or in part without written permission. Trane reserves the right to revise this publication at any time, and to make changes to its content without obligation to notify any person of such revision or change.

Trademarks

All trademarks referenced in this document are the trademarks of their respective owners.

Revision History

- Updated tables in the Electrical Data chapter.
- Added information about R-32 refrigerant.
- Added VRF Applications to the General Data chapter.

- Updated electric heat capacity table in the Performance Data chapter.
- Updated model number description for Digit 17.
- Clarified Hydronic Coil Freeze Protection information for units with R-454B refrigerant.



Table of Contents

Features and Benefits	6
Wide Variety of Heating/Cooling Coils.....	6
Building Automation	6
Equipment Size.....	7
Cabinet Finish	7
Accessibility.....	7
Energy Efficiency	7
Component Flexibility	8
Controls	9
Leak Detection System	9
Certification Standards	9
Application Considerations	11
Typical arrangements	11
Condensate Piping.....	12
Ducted Applications	13
Condensate.....	13
Performance	13
A2L Application Considerations.....	15
Leak Detection System(Refrigerant charge greater than 3.91 lb of R-454B or 4.04 lb of R-32 per circuit).....	15
Selection Procedure	16
Determine Cooling and/or Heating Loads	16
Determine Unit Size	16
Select the Coil	17
Leak Detection System(Refrigerant charge greater than 3.91 lb of R-454B or 4.04 lb of R-32 per circuit).....	17
Model Number Description	18
General Data	20
Discharge and Inlet Arrangements	20
Motor Data.....	21
Grille Data	21
Coil Data	21
Controls Data	27
Performance Data	28
Coil Performance	28

Controls	37
Why Trane Controls?	37
VelociTach™ Motor Control Board	38
Control Options	39
Tracer® Controllers	39
Tracer® Controller Features	40
Tracer® Controls Sequence of Operation	44
Air-Fi® Wireless Systems	44
Zone Sensor Options	45
End Device Options	47
Electrical Data	48
Acoustical Data	51
Piping	52
Factory-Installed Piping Packages	52
Piping Package Components	52
Control Valves	53
Dimensional Data	55
Unit Dimensions and Weights	55
Discharge Dimensions	55
Inlet/Discharge Arrangements	59
Drain Pan Connection	60
Mechanical Specifications	61
General	61
Coils	61
Leak Detection Sensors	62
Unit Fans	62
Motors	62
Dampers	62
Drain Pan	63
Filters	63
Controls	63
Piping Packages	63

Features and Benefits

The beauty of the classroom unit ventilator stems beyond its ability to heat and cool. The Trane unit ventilator design provides an opportunity to create a comfortable atmosphere for living, learning and playing, while providing energy efficiency savings with market-leading technology. Some of the featured benefits of a unit ventilator are:

- Individual room control.
- Fresh air ventilation and filtration.
- Individual dehumidification sequences per zone.
- Energy savings solutions through economizing functions.
- A choice in heating/cooling applied systems.
- Because the equipment is mounted directly in the space, installation costs are minimal compared to other HVAC systems.

Figure 1. System choice for the classroom unit ventilator

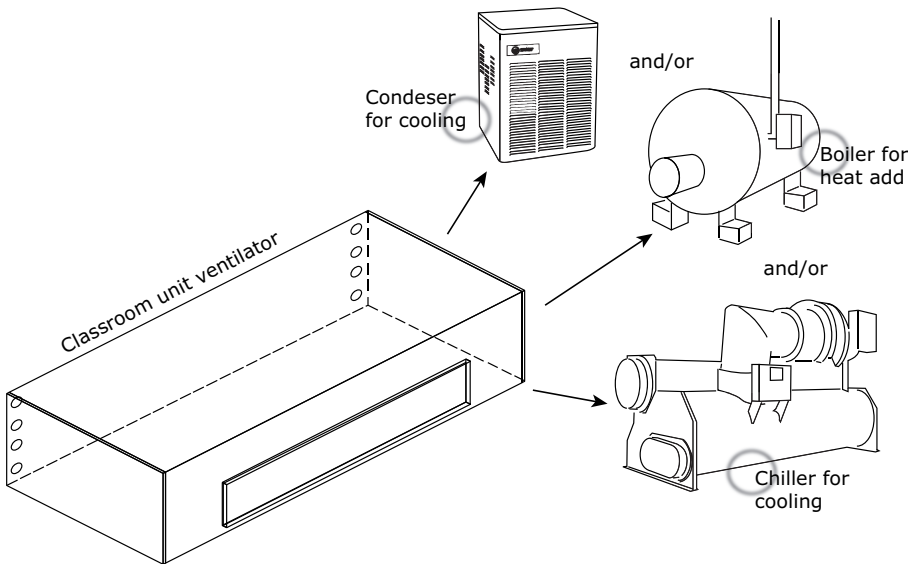

Wide Variety of Heating/Cooling Coils

Trane's unit ventilator offers a wide variety of coil configurations.

In environments where cooling needs are of main interest, a two-pipe coil coupled with a chiller, or a direct expansion coil joined with a condensing unit may be used.

For heat specific applications, Trane offers a two-pipe hot water only unit to be combined with a boiler. Electric heat and steam options are also available for heat fixed conditions.

When there is seasonal heating and cooling, a two-pipe chilled water/hot water changeover system may be applicable to the mechanical design. This system requires a chiller and a boiler to support the changeover necessity. However, where space constraints may present a concern, the Trane unit ventilator may be equipped with a direct expansion coil for cooling, with an auxiliary electric heat coil, hot water coil, or steam coil for heating.

Four-pipe chilled water/hot water systems are also available. This system is typically applied when both heating and cooling may be simultaneously called for in the school structure.

Building Automation

As part of the building automation system, the mechanical HVAC system may be optimized to lower energy consumption. By running only the mechanical devices that are required to support the building load at a given time of day or night, true energy consumption savings may be achieved.

Maintenance and serviceability faults through the unit sensing devices are easily defined and cured with an automated system. With factory shipped direct digital controls, installation and start-up of the system are more simple.

Equipment Size

The horizontal unit ventilator delivers from 750 cfm to 2000 cfm. Trane unit ventilator is sized to fit any replacement or new construction application.

Cabinet Finish

The unit cabinetry is made of durable industrial grade metal for hard wearing applications. All steel surfaces are cleaned, rinsed and dried before applying a final paint finished on metal that may be exposed to the room decor.

Accessibility

Access to the air filter is made through the bottom of the unit providing effortless access for filter changeout. The access panel is available with a safety chain option for protection from dropping the panel during normal maintenance situations.

Figure 2. Cabinet access

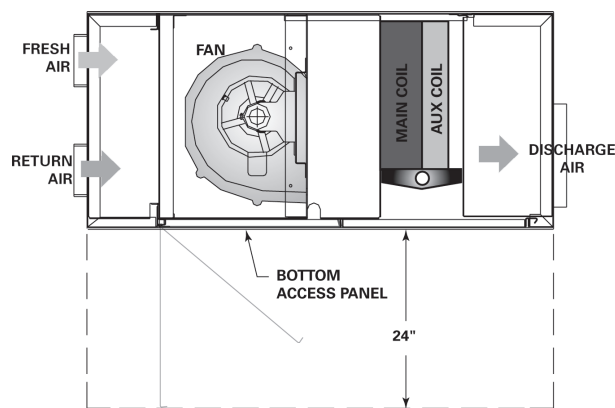

Spacious End Pockets

The 13-1/2-inch wide by 30-inch high by 15-1/4-inch deep (standard) to provide uncomplicated field installation of valves, piping, and controls. Several large knockouts are provided in both the left and right end pockets for electrical and piping connections.

Control Connections

All electrical connections are made in the left-hand end pocket for equipment not specified with electric heat. Units equipped with the electric heat option have in-coming power connections made in the righthand end pocket.

Fan Board

The fan board assembly is acoustically designed in a single, rigid assembly that includes the fans, fan housing, bearings, fan shaft and motor. The fan motor is mounted on the heavy gauge, galvanized fan board assembly to help resist corrosion while increasing strength and rigidity. The fan board is removable through two metal screws for service or maintenance/cleaning of the fan housings.

Energy Efficiency

Trane's commitment to providing premium quality products has led to the exclusive use of Electronically Commutated Motors (ECM) in all Unit Ventilators. These brushless DC motors incorporate the latest technology for optimized energy efficiency, acoustical abatement, maintenance free and extended motor life. Each motor has a built-in microprocessor that allows for programmability, soft ramp-up, better airflow control, and serial communication.

- Trane units equipped with ECMs are significantly more efficient than the standard Permanent Split Capacitor (PSC) motor.
- Lower operating costs on average of 50 percent (versus a PSC motor).
- The Reduced FLA feature allows units to ship with a nameplate FLA rating much lower than a typical ECM unit.



Features and Benefits

Electronically Commutated Motor (ECM)

The fan motor is a variable speed electronically commutated motor with overload protection. The motor is wired to either termination board so the unit can be control with either three fan speeds or 0 Vdc to 10 Vdc. The motor speed is not affected by damper positions. Standard motors are rated up to 0.25 ESP (external static pressure). High static motors are rated from 0.25 ESP to 0.45 ESP. Bearings for the motor are permanently lubricated.

The motor is removable without complete disassembly of the fan board. Simply remove the two motor quick-connects and loosen the shaft coupling.

Component Flexibility

Filters

Filters for the horizontal unit ventilator are of 1-inch, throwaway, MERV 8, or MERV 13. They are shipped with the equipment for installation/start-up purposes. Extra filters may be ordered separately for maintenance of the equipment.

Drain Pan

The unit drain pan is positively sloped to assure proper drainage. The pan is insulated on the bottom to help prevent condensate formation. The pan is simple to remove for cleaning purposes by loosening two front screws.

Piping

Hydronic piping for the unit ventilator may be factory-installed or field-provided. It fits inside the unit end pockets, allowing for quick hook-up during the installing phase. The motorized valves include a troublefree, pop-top actuator allowing the maintenance or service technician access to the motor without removing the valve body from the piping package.

Coils

Through the various coil combinations offered by Trane, room conditions can be met. Two-pipe and fourpipe combinations are available to support any application. Coil selections include hydronic, steam, directexpansion (DX) and electric. For heating coils, Trane provides steam, hot water and electric options. Cooling coils are available as cold water and DX. Access to the coil for cleaning purposes is fundamentally one of the greatest features Trane provides as part of the equipment. Maintaining a clean coil inherently increases the efficiency adds to the life of the equipment, and helps to maintain proper indoor air quality.

Outside/Return-Air Damper Design

The outside/return air (OA/RA) damper is a dual blade system to ensure proper modulation and mixing of the air to AHRI-840 economizing standards.

The optional outside air actuator is spring return. The spring return system closes the OA damper if power is lost to the building and provides for a positive seal. This helps inhibit over cooling or freeze-up of the system during electrical outages or system shut-down.

When ordered with factory mounted Trane® controls, the actuator is 3-point floating arrangement. A 2 to 10 Vdc or 3-point floating actuator is available when Customer Supplied Terminal Interface (CSTI) are specified.

Face-and-Bypass Design

The optional face-and-bypass design can provide active energy savings to the owner. This design works best during seasonal changeover. It also supports morning warm-up when lower air temperatures can easily be drawn into the system before normal classroom operation begins.

The design allows the damper to bypass the cooling coil to supply cool, untreated OA into the room. An optional 2-position isolation valve enhances this system by closing off water to the coil to prevent the room temperature from rising too far above or below the intended setpoint.

Figure 3. Face-and-bypass damper

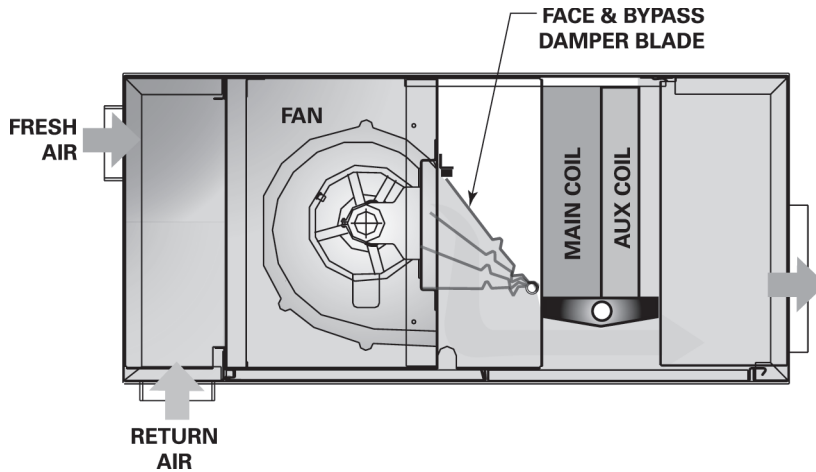

Controls

- This is the industry's first solution that is factory-mounted, -wired, and -programmed for infinite modulation of fan speed based on space loads, using the Symbio™ 400-B.
- All controls are factory-mounted and tested to minimize field setup and improve reliability.

Note: *Factory addressing is available for Symbio 400-B and Air-Fi® WCI controller types. This option allows configuration of units before delivery, reducing the field setup time.*
- Controls are wired with a 24-Vac transformer to keep only a single source power connection requirement to the unit.
- All wall-mounted zone sensors require only low voltage control wiring from the device to the unit control box. (no line voltage).
- The controller automatically determines the unit's correct operating mode (heat/cool) by utilizing a proportional/integral (PI) control algorithm to maintain the space temperature at the active setpoint, allowing total comfort control.
- Entering water temperature sampling eliminates the need for inefficient bleedlines to sense automatic changeover on two-pipe changeover units.
- The random start-up feature helps reduce electrical demand peaks by randomly staggering multiple units at start-up.
- Occupied/unoccupied operation allows the controller to utilize unoccupied temperature setpoints for energy savings.
- Warm-up and cool-down energy features are standard with Trane controls.
- To customize unit control, Symbio 400-B uses Tracer® TU.
- Maximize system efficiency with free cooling economizers and modulating valves on units with Symbio 400-B.
- Trane offers a broad range in control packages to fit both retrofit and new applications. From CSTI to a complete building automation system, Trane controls integrate the highest quality components within their unit ventilator to allow greater optimization of the entire system.

Leak Detection System

The Leak Detection System (LDS) consists of one or more refrigerant detection sensors and is required in ducted HVAC systems that have more than 3.91 lb of R-454B or 4.04 lb of R-32 refrigerant charge, per safety standard UL 60335-2-40. For any units with more than 3.91 lb of R-454B or 4.04 lb of R-32 refrigerant charge in a circuit, an LDS will be factory-installed.

Note: *If factory installed controls are not selected, leak detection sequence of operation must be programmed by controls contractor. See UL 60335-2-40 for more information.*

Certification Standards

Comfort, energy and IAQ are all major issues that need to be considered in today's school designs. Therefore, it is important that designers of these systems have accurate information to make system decisions. That is why the industry has developed performance standards and certification programs which ensure that the equipment information provided to the design



Features and Benefits

community is correct and comparable across different manufacturers. The following list of certifications identifies Trane's commitment in providing the highest quality equipment to their customers.

- AHRI-840
- UL
- Rated in accordance to AHRI 350 (sound)
- BTL (Symbio™ 400-B)

Application Considerations

Typical arrangements

Fully Recessed Unit

The horizontal unit ventilator may be fully recessed into the ceiling space to provide greater noise reduction to the space. With this application, duct collars on the outside air inlet, return air inlet and discharge air outlet are available for ease of duct work connection to the equipment.

Figure 4. Fully recessed unit

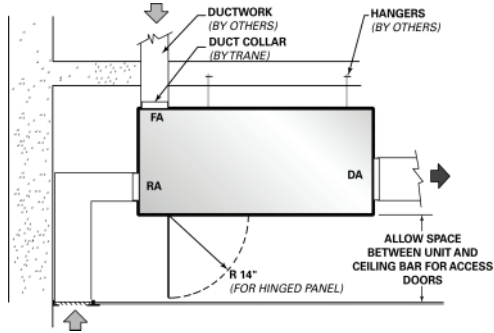

Partially Exposed Unit

In situations where greater access to system components is a must (such as filter change out), a partially exposed unit may be a practical solution. With the partially exposed return/discharge air bottom arrangement, the unit cabinet width increases by 13-1/8 inches for 075–150 unit sizes, and by 14-1/8 inches on the size 200 unit.

Figure 5. Partially exposed unit

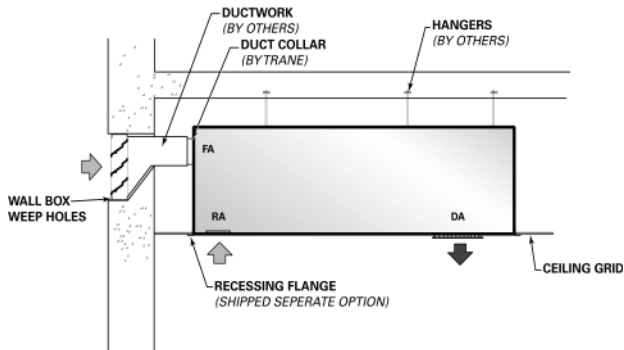

Fully Exposed Unit

The horizontal unit ventilator may be fully exposed to the classroom or institution. The most typical arrangement for this application includes a fresh air, ducted upper back with a return air, bar grille on the bottom. Combined with a front discharge grille, this arrangement provides a cost effective way to support individual fresh-air ventilation, while freeing up precious floor space.

Note: All horizontal units have an appliance grade paint finish.

Figure 6. Fully exposed unit

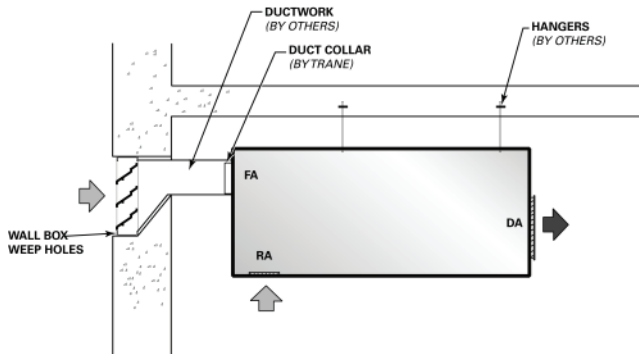

Partially Exposed Unit with Double-Deflection Discharge

Another example of a partially exposed unit ventilator includes a fresh air upper back, with a return air lower back, combined with a bottom, double-deflection discharge. This application requires field supplied duct work to be added to the return air side of the unit ventilator.

Figure 7. Partially exposed unit with double-deflection discharge

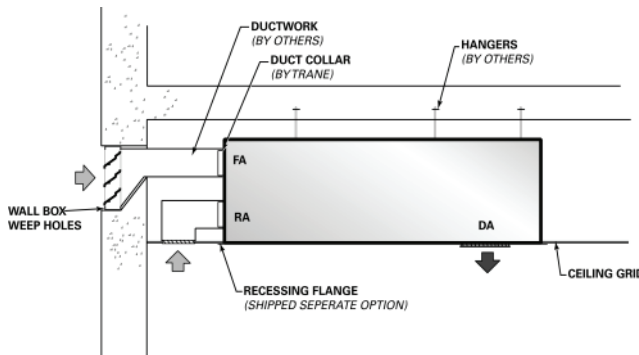

Partially Exposed Unit with Ducted Discharge

A ducted discharge option is available to support the many design layouts expected of the mechanical system. The location of the discharge ducting could be critical during installation due to such issues as recessed lighting. Trane provides three selectable ducted discharge locations to reduce interference of other trades on the job site.

Figure 8. Partially exposed unit with ducted discharge

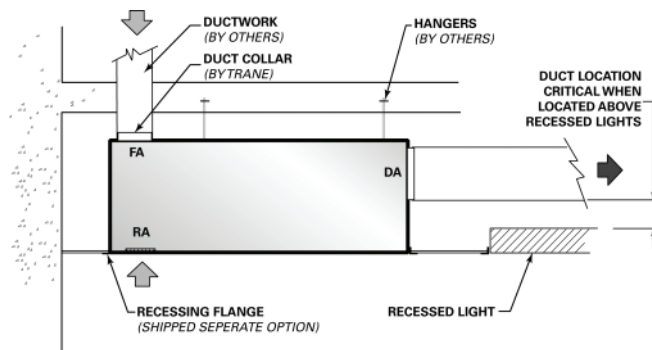

Condensate Piping

The horizontal unit ventilator drain pan connection is located on the same side as the cooling coil connections (hydraulic and DX coils). The stubout size is 3/4-inch outside diameter.

Ducted Applications

A well designed duct system is beneficial to obtaining satisfactory fan performance. Determining resistance losses for the duct work system is also necessary for acceptable fan performance. Assistance in the design of duct work can be found in the ASHRAE Handbook. The unit ventilator is designed to operate against ESP thru 0.45-inch. The ESP is determined by adding the discharge air static pressure to the greater of either the outdoor air static pressure or the return air static pressure.

Condensate

Proper condensate trapping is required for the classroom unit ventilator's with hydronic and DX coils. In a properly trapped system, when condensate forms during normal operation, the water level in the trap rises until there is a constant flow of water through the pipe.

Performance

Application of this product should be within the catalogs airflow and unit performance. Trane Select Assist™ will aid in the selection process for a set of given conditions. If this program has not been made available, ask a local Trane sales account manager to supply the desired selections or provide a copy of the program.

Freeze Protection

The most important advantage the Trane blow-thru design provides is additional protection against coil freeze-up. In contrast, draw-thru configurations allow little mixing of the return and outside air stream while locating the coil very close to the outside air inlet. This process creates "cold spots" on the coil which could lead to coil freeze-up.

With a blow-thru design, face and bypass with isolation valve control is not necessary (as with other manufacturers) to provide proper freeze protection to the unit ventilator. This adds cost and more mechanical components that could break down. The placement of the coil above the fan allows enough space for the coil to avoid "cold spots" that could cause freezing.

Ventilation for Acceptable IAQ

Supplying proper ventilation to a classroom is challenging. The various rooms that make up a school are forever changing in their proper ventilation needs. Building occupants and their activities generate pollutants that heighten the ventilation requirements. And because of this intermittent occupancy, the ventilation frequency of a classroom is constantly on the move.

Ventilation systems dilute and remove indoor contaminants, while mechanical heating and cooling systems control the indoor temperature and humidity. Supplying an adequate amount of fresh air to an occupied classroom is necessary for good indoor air quality. IAQ should be considered a top priority in the school environment because children are still developing physically and are more likely to suffer the consequences of indoor pollutants. For this reason, air quality in schools is of particular concern. Proper conditioning of the indoor air is more than a quality issue; it encompasses the safety and stewardship of our investment in the students, staff and facility. The beauty of a classroom unit ventilator is its ability to provide heating, cooling, ventilation and dehumidification as a single-zone system.

Hydronic Branch Conductor

The Hydronic Branch Conductor is a self-contained valve assembly with integrated controls. This innovative system features advanced controller logic that detects both hot and cold water temperatures, seamlessly directing flow from the appropriate heat pump loops to either heat or cool specific thermal areas.

Trane Hydronic Branch Conductor revolutionizes building climate control by enabling the use of dual-purpose coils within a four-pipe distribution system, while efficiently delivering heating or cooling through just two pipes. Unlike traditional two-pipe changeover systems that switch between hot and cold water seasonally for the entire building, this advanced system can adapt to varying heating and cooling demands in different areas multiple times throughout the day.

With a central four-pipe distribution system providing the benefits of year-round heating and cooling, and area branches utilizing a two-pipe setup, the Hydronic Branch Conductor offers reduced piping complexity and enhanced efficiency. Experience the best of both worlds with a heat pump system that combines the advantages of four-pipe and two-pipe configurations for optimal climate control.

Application Considerations for the Hydronic Branch Conductor:

- Hydronic Branch Conductors are for use in hydronic heat pump systems where the cooling fluid and heating fluid are the same fluid from the same central plant. It is not for use in systems with a chiller plant for cooling and a traditional boiler system for heat.

Application Considerations

- The Hydronic Branch Conductor conducts—commands valves to provide the appropriate fluid to meet the received thermal area HEAT/COOL mode. It also monitors and reports the status of the hydronic flows for the thermal area.
- The Hydronic Branch Conductor is placed between the main building pipe chase and a thermal area's branch piping.
- The Hydronic Branch Conductor does not take the place or function of zone control valves.
- The Hydronic Branch Conductor does not take the place of any necessary shut off or balancing valves.
- Systems with Hydronic Branch Conductors have airside equipment with dual purpose coils. These coils work well using hot water supply temperature of 100F(+/-10F) and traditional chilled water temperatures.

See *Hydronic Branch Conductor Application Guide (APP-APG024*-EN)* for more information on system design.

ASHRAE Control Cycles

Figure 9. ASHRAE cycle graph

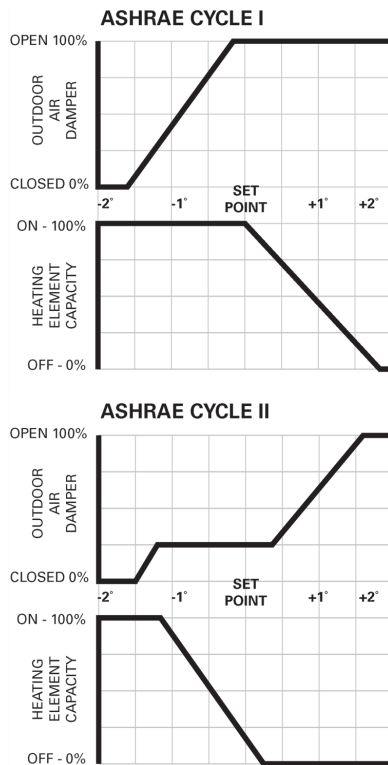

There are a variety of control systems available in unit ventilators. The exact method of controlling the amount of outside air and heating capacity can vary. However, all systems provide a sequence of operation designed to provide rapid classroom warm-up and increasing amount of ventilation air to offset classroom overheating. Reasons for classroom overheating can include:

- Sun or solar heat produced through large glass areas in a school.
- Lighting.
- Students

To help supply proper ventilation to these fluctuating heat gains, the Trane unit ventilator is designed to provide rapid classroom warm-up and increasing amounts of ventilation air to offset classroom overheating.

ASHRAE Cycle I: All standard unit ventilator cycles automatically close the outside air damper whenever maximum heating capacity is required. As room temperature approaches the comfort setpoint, the outside air damper opens fully, and the unit handles 100 percent outside air. Unit capacity is then controlled by modulating the heating element capacity.

ASHRAE Cycle I is typically used in areas where a large quantity of outdoor air is required to offset the air being exhausted to relieve the room of unpleasant odors and particles.

ASHRAE Cycle II: ASHRAE Cycle II is the most widely used ventilation control. Similar to Cycle I, the outside air damper is closed during warm-up. But with Cycle II, the unit handles recirculated air through the return air system. As temperature approaches the comfort setting, the outside air damper opens to admit a predetermined minimum amount of outside air. This

minimum has been established by local code requirements and good engineering practices per AHRI- 840. Unit capacity is controlled by varying the heating element output. If room temperature rises above the comfort setting, the heating element is turned off and an increasing amount of outside air is admitted until only outside air is being delivered.

ASHRAE Cycle II is a very economical control sequence often referred to as integrated economizing. This design supports optimum ventilation and provides the greatest energy savings. This is further proof of why AHRI-840 certification is important in minimizing energy consumption through economizer performance.

A2L Application Considerations

This product is listed to UL standard 60335-2-40, Household and Similar Electrical Appliances – Safety – Part 2-40: Particular Requirements for Electrical Heat Pumps, Air-Conditioners and Dehumidifiers, which defines safe design and use strategies for equipment using A2L refrigerants. This standard limits the refrigerant concentration in a space in the event of a refrigerant leak. To meet the requirements, the UL standard defines minimum room area, refrigerant charge limit, minimum circulation airflow and/or ventilation airflow requirements, and limits the use of ignition sources in spaces. The standard requires a unit refrigerant leak detection system.

For equipment with less than or equal to 3.91 lb of R-454B or 4.04 lb of R-32 refrigerant charge per circuit, this UL standard does not prescribe a room area limit and does not require a refrigerant leak detection system or any circulation airflow or ventilation airflow mitigation strategies. However, ignition sources in ductwork must be evaluated.

Depending on the application, a specific requirement of ANSI/ASHRAE Standard 15, Safety Standard for Refrigeration Systems, could be more stringent than UL 60335-2-40 requirements. See *Refrigeration Systems and Machinery Rooms Application Considerations for Compliance with ASHRAE® Standard 15-2022 Application Engineering Manual (APP-APM001*-EN)* for more information.

Leak Detection System (Refrigerant charge greater than 3.91 lb of R-454B or 4.04 lb of R-32 per circuit)

The leak detection system consists of one or more refrigerant detection sensors. When the system detects a leak, the following mitigation actions will be initiated until refrigerant has not been detected for at least 5 minutes:

- Energize the supply fan(s) to deliver a required minimum amount of circulation airflow.
- Disable compressor operation.
- Provide an output signal to fully open all zoning dampers, such as VAV boxes.
- Provide an output to energize additional mechanical ventilation (if needed).
- Units without airflow proving will disable electric heat sources.

Building fire and smoke systems may override this function.

If the refrigerant sensor has a fault, is at the end of its life, or is disconnected, the unit will initiate the mitigation actions. Mitigation actions may be verified by disconnecting the sensor.

The refrigerant sensors do not need service. Use only manufacturer-approved sensors when replacement is required.

Notes:

- *Factory-installed Symbio™ 400-B controllers are programmed with leak detection sequence of operations at the factory.*
- *Field-installed unit controllers require field programming of the leak detection sequence of operations by the controls contractor. See UL 60335-2-40 for more information.*



Selection Procedure

Trane horizontal classroom unit ventilators provide air delivery and capacities necessary to meet the requirements of modern school classrooms. They are available with the industry's widest selection of coils to precisely satisfy heating, ventilating and air conditioning loads with the best individual type of system.

1. Determine the classroom/space unit cooling and/or heating loads.
2. Determine the unit size.
3. Select the coil.

Determine Cooling and/or Heating Loads

The first step in unit ventilator selection is to determine room heating and air conditioning loads. The calculation of this load is essential if the equipment is to be economical in first cost and operating cost.

Adequate ventilation is mandatory in classroom air conditioning design. The amount is often specified by local or state codes and, in air conditioned schools, may be either the same or less than that specified for heating systems. The usual requirement is between 15 and 25 cfm of outside air per occupant, based on the intended use of the room. For instance, a chemistry laboratory normally requires more ventilation for odor control than a low occupancy speech clinic.

Ventilation is an important concern and should be accurately determined to assure good indoor air quality. Purposely oversizing units should be avoided, since it can cause comfort and control issues.

Determine Unit Size

Unit ventilator size is determined by three factors:

- Total air circulation.
- Ventilation cooling economizer capacity required.
- Total cooling or heating capacity required.

Total air circulation, if not specified by code, should be sufficient to ensure comfort conditions throughout the room. This is usually from six to nine air changes per hour, but can vary with room design and exposure. Often rooms with large sun exposure require additional circulation to avoid hot spots.

Ventilation cooling capacity is determined by the amount of outside air delivered with the outside air damper fully open, and the temperature difference between the outside air and the classroom. In air conditioning applications, ventilation cooling capacities should maintain the comfort setting in the classroom whenever the outside air temperature is below the unit or system changeover temperature.

Example:

Ventilation cooling capacity = 1.085 x cfmt x (T1 - T2)

cfmt = Total air capacity of unit with outside air damper open 100%

T1 = Room temperature

T2 = Outside air temperature

In classrooms with exceptionally heavy air conditioning loads, unit size may be determined by the total cooling requirement. Good practice dictates 375 to 425 cfm per ton of hydronic cooling capacity. Normally, however, Trane classroom air conditioner coils have sufficient capacities.

Example:

Given: Air circulation specified = 8 air changes per hour

Classroom size = 35 ft long x 25 ft wide x 10 ft high

Inside design air temperature = 75°F

Ventilation cooling required at 58°F = 29,000 BTU

CFM required = [8 changes/hr x (35 x 25 x 10) ft³] / (60 minutes/hr) = 1170 cfm

Checking ventilation cooling capacity:

29,800 BTU = 1.085 x CFM x (80-58)

CFM = 1250

This indicates that a 1250 cfm unit would have satisfactory ventilation cooling capacity at the design changeover point of 58°F. Coil capacity will become confirmed when the coil is selected.

Select the Coil

Selecting the correct coil is done through Trane Select Assist™. For your convenience, Trane Select Assist™ has a mixed air calculator built into the program.

Leak Detection System (Refrigerant charge greater than 3.91 lb of R-454B or 4.04 lb of R-32 per circuit)

The leak detection system consists of one or more refrigerant detection sensors. When the system detects a leak, the following mitigation actions will be initiated until refrigerant has not been detected for at least 5 minutes:

- Energize the supply fan(s) to deliver a required minimum amount of circulation airflow.
- Disable compressor operation.
- Provide an output signal to fully open all zoning dampers, such as VAV boxes.
- Provide an output to energize additional mechanical ventilation (if needed).
- Units without airflow proving will disable electric heat sources.

Building fire and smoke systems may override this function.

If the refrigerant sensor has a fault, is at the end of its life, or is disconnected, the unit will initiate the mitigation actions. Mitigation actions may be verified by disconnecting the sensor.

The refrigerant sensors do not need service. Use only manufacturer-approved sensors when replacement is required.

Notes:

- *Factory-installed Symbio™ 400-B controllers are programmed with leak detection sequence of operations at the factory.*
- *Field-installed unit controllers require field programming of the leak detection sequence of operations by the controls contractor. See UL 60335-2-40 for more information.*



Model Number Description

Digit 1, 2, 3 — Unit Configuration

HUV = Horizontal Unit Ventilator

Digit 4 — Development Sequence

C = Third generation

Digit 5, 6, 7 — Capacity; Nominal

075 = 750 CFM
100 = 1000 CFM
125 = 1250 CFM
150 = 1500 CFM
200 = 2000 CFM

Digit 8 — Voltage (Volt/Hz/Phase)

1 = 120V/60/1
2 = 208V/60/1
3 = 208V/60/3
4 = 240V/60/1
5 = 240V/60/3
6 = 277V/60/1
8 = 480V/60/3-phase 4-wire power supply

Digit 9 — Motor

0 = Free discharge ECM
7 = Free discharge ECM, low FLA
A = High static ECM
H = High static ECM, low FLA

Digit 10, 11 — Design Sequence

** = Design sequence

Digit 12, 13 — Coil Letter Designation

(Single Coil Options)

AA = 2-row, 12 fpi chilled-water/hot - water changeover
AB = 2-row, 16 fpi chilled-water/hot - water changeover
AC = 3-row, 12 fpi chilled-water/hot - water changeover
AD = 4-row, 12 fpi chilled-water/hot - water changeover
AE = 4-row, 16 fpi chilled-water/hot-water changeover
H1 = 1-row, 12 fpi heating coil
H2 = 1-row, 14 fpi heating coil
H3 = 1-row, 16 fpi heating coil
H4 = 2-row, 12 fpi heating coil
H5 = 2-row, 14 fpi heating coil
H6 = 2-row, 16 fpi heating coil
K1 = 1-row low capacity steam coil
K2 = 1-row high capacity steam coil
G0 = 2-row, 12 fpi DX coil

Digit 12, 13 — Coil Letter Designation (continued) (Coupled Coil Options)

DA = 1-row, 12 fpi hot-water coil with 2-row, 12 fpi chilled-water coil
DC = 1-row, 12 fpi hot-water coil with 2-row, 14 fpi chilled-water coil
DD = 1-row, 12 fpi hot-water coil with 3-row, 12 fpi chilled-water coil
DE = 1-row, 14 fpi hot-water coil with 3-row, 14 fpi chilled-water coil
DK = 1-row steam coil with 3-row chilled-water coil
X3 = 3-element electric coil with 3-row chilled-water coil (2-row on size 125)
GK = 1-row steam coil with 2-row DX coil
GA = 1-row heating coil with 2-row DX coil
G3 = 3-element electric heat coil with 2-row DX coil
R1 = 3-row, 12 fpi chilled-water coil with 1-row, 12 fpi hot-water coil
R2 = 3-row, 14 fpi chilled-water coil with 1-row, 12 fpi hot-water coil

Digit 14 — Coil Connections

A = Right-hand supply
B = Left-hand supply
C = 2 coil LH cooling/RH heating
D = 2 coil RH cooling/LH heating

Digit 15 — Control Types

E = Symbio™ 400-B
F = Symbio 400-B with time clock
G = Symbio 400-B with Air-Fi Wireless Communications Interface (WCI)
N = CSTI fan status
8 = Customer-supplied terminal interface (CSTI)
9 = CSTI with low temp

Digit 16 — Face-and-Bypass/Electric Heat Stages

0 = None
1 = Face-and-bypass damper - field installed actuator
8 = Face-and-bypass damper - factory installed actuator
4 = Single-stage electric heat control
5 = Dual-stage electric heat control

Digit 17 — Refrigerant Types

A = No Refrigerant
B = R-410A replacements only
C = R-454B
D = R-32
E = R-410A (VRF replacements)

Digit 18 — Damper Configuration

0 = Field-installed damper actuator
1 = 100% return air/no damper or actuator (Modulating ASHRAE Cycle II)
F = Return air/outside air damper and actuator (2-10 Vdc)
A = Return air/outside air damper and actuator (3-point modulating)
E = Return air/outside air damper and actuator with exhaust (3-point modulating) (Two Position Control)
D = Damper with manual quad adjustment

Digit 19 — Zone Sensor/Fan Speed Switch

0 = No sensor - unit-mounted fan speed switch (CSTI)
A = Wall-mounted
J = Wall-mounted zone sensor (OALMH; setpoint dial; OCC/UNOCC)
K = Wall-mounted zone sensor (OALMH; setpoint dial)
L = Unit-mounted zone sensor (OALMH; setpoint dial)
M = Wall-mounted display sensor with setpoint adjustment
P = Wall-mounted sensor (setpoint dial; OCC/UNOCC with unit mounted speed switch)
Q = Wall-mounted sensor (setpoint dial) with unit speed switch
3 = Wireless display sensor (OALMH)
4 = Wireless sensor - ext adjustment
5 = Unit-mounted variable fan speed control (CSTI)

Digit 20 — Inlet Arrangement

A = Fresh air (FA) duct top/return air (RA) duct lower back
B = Fresh air duct top/return air duct bottom
C = Fresh air duct top/return air bar grille bottom
F = Fresh air duct upper back/return air duct lower back
G = Fresh air duct upper back/return air duct bottom
H = Fresh air duct upper back/return air bar grille bottom
J = Fresh air duct upper back/return air open bottom
K = 100% fresh air duct upper back
L = 100% return air duct lower back
M = 100% return air duct bottom
N = 100% return air bar grille bottom
P = 100% return air open bottom

Digit 21 — Discharge Arrangement

- 1 = Bar grille discharge
- 2 = Duct collar discharge per submittal
- 3 = Duct collar discharge 3/4 in. from top
- 5 = Front double deflection grille discharge

Digit 22 — Unit Access Panel

- 0 = Standard horizontal access panel
- 1 = Safety chain/standard access panel
- 2 = Removable access panel
- 3 = Safety chain/removable access panel

Digit 23 — Recessing Flange

- 0 = No recessing flange
- 1 = Standard recessing flange

Digit 24 — Piping Package

- 0 = None
- E = Basic - ball valve supply and return
- F = Basic - ball valve supply and manual circuit setter return
- G = Deluxe - ball valve supply and manual circuit setter return
- H = Deluxe - ball valve supply and return with auto flow

Digit 25 — Filter

- 1 = Throwaway filters
- 2 = MERV8 filter
- 3 = MERV13 filter

Digit 26 — Color Selection

- 1 = Deluxe beige cabinet
- 2 = Cameo white cabinet
- 3 = Soft dove cabinet
- 4 = Stone gray cabinet
- 5 = Driftwood gray cabinet

Digit 27 — Motor Disconnect

- A = Non-fused toggle
- B = Circuit breaker

Digit 28 — Control Accessories

- 0 = None
- A = CO₂ sensor control support
- B = Wall-mounted relative humidity sensor (Options)
- C = Air-Fi dehumidification and CO₂
- D = Air-Fi dehumidification
- E = Air-Fi CO₂

Digit 29 — Future Option

- 0 = None

Digit 30 — Cooling/Changeover Valve Type

- 0 = None
- A = 2-way, 2-position N.C.
- B = 2-way, 2-position N.O.
- C = 3-way, 2-position N.C.
- D = 3-way, 2-position N.O.
- E = 2-way, modulating
- F = 3-way, modulating
- G = 2-way, analog (2-10 Vdc)
- H = 3-way, analog (2-10 Vdc)
- J = Field supplied, 2-position N.C.
- K = Field supplied, 2-position N.O.
- L = Field supplied, modulating
- M = Field supplied, analog (2-10 Vdc)

Digit 31 — Cv Cooling/Changeover Valve

- 0 = None
- A = 2-way 2.3 Cv
- B = 2-way 3.3 Cv
- C = 2-way 4.6 Cv
- D = 2-way 6.6 Cv
- E = 3-way 2.7 Cv
- F = 3-way 4.6 Cv
- G = 3-way 7.4 Cv

Digit 32 — Heating Valve Type

- 0 = None
- A = 2-way, 2-position N.C.
- B = 2-way, 2-position N.O.
- C = 3-way, 2-position N.C.
- D = 3-way, 2-position N.O.
- E = 2-way, modulating
- F = 3-way, modulating
- G = 2-way, analog (2-10 Vdc)
- H = 3-way, analog (2-10 Vdc)
- J = Field supplied, 2-position N.C.
- K = Field supplied, 2-position N.O.
- L = Field supplied, modulating
- M = Field supplied, analog (2-10 Vdc)

Digit 33 — Cv Heating Valve

- 0 = None
- A = 2-way 1.4 Cv
- B = 2-way 2.4 Cv
- C = 2-way 3.4 Cv
- D = 2-way 4.8 Cv
- E = 2-way 5.9 Cv
- F = 3-way 2.7 Cv
- G = 3-way 4.6 Cv
- N = 3-way 7.4 Cv
- J = Steam 1.8 Cv valve only
- K = Steam 4.6 Cv valve only
- P = Steam 7.3 Cv valve only

Digit 34 — Cooling/Changeover Auto Flow GPM

- 0 = None
- A = 4.0
- B = 4.5
- C = 5.0
- D = 6.0
- E = 6.5
- F = 7.0
- G = 8.0

Digit 35 — Heating Auto Flow GPM

- 0 = None
- A = 1.0
- B = 1.5
- C = 2.0
- D = 2.5
- E = 3.0
- F = 3.5
- G = 4.0
- H = 4.5
- J = 5.0
- K = 6.0



General Data

Discharge and Inlet Arrangements

Figure 10. Discharge and inlet arrangements

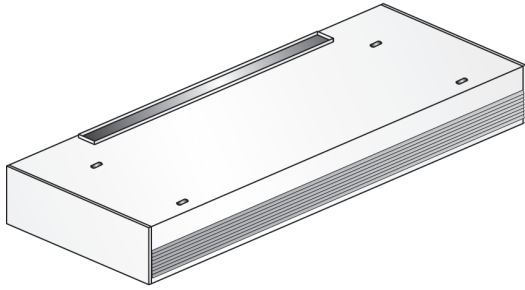

Discharge Arrangement



Digit 21 = 1
(1) Bar Grille Discharge



Digit 21 = 2
(2) Duct Collar Discharge
7 1/8" from Top

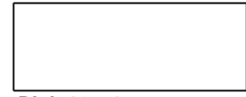

Digit 21 = 3
(3) Duct Collar Discharge
3/4" from Top



Digit 21 = 5
(5) Double Deflection Grille Discharge

Note: Bottom discharge adds 13 1/8" to unit sizes 075-150 and 14 1/8" to unit size 200

Inlet Arrangement

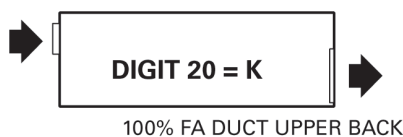
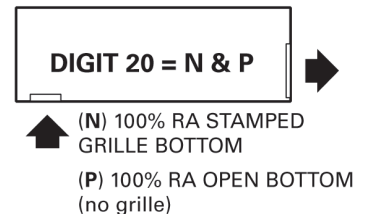
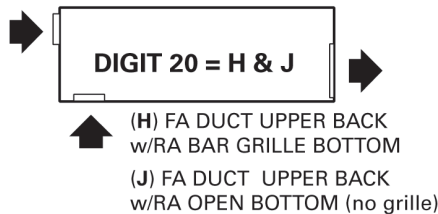
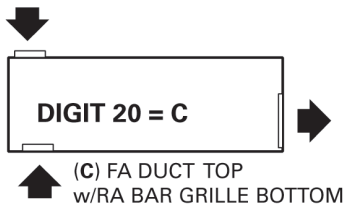
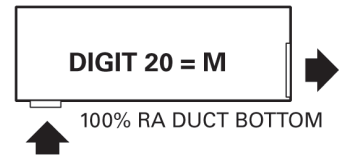
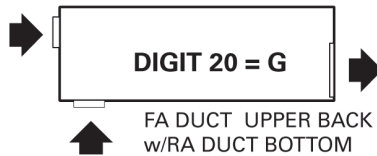
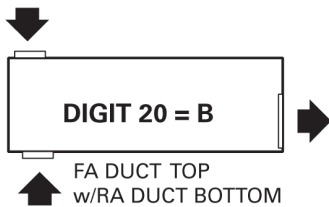
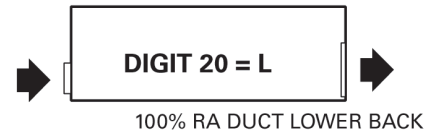
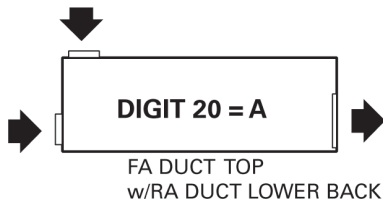

Motor Data

Table 1. Standard motor data (typical for AA coil)

Unit Size	Volts	RPM (Nominal)	CFM (Nominal)	Amps (FLA)	Watts	HP
75	115/60/1	1050	750	13	135	1
100	115/60/1	1050	1000	13	180	1
125	115/60/1	1050	1250	13	191	1
150	115/60/1	1050	1500	13	221	1
200	115/60/1	875	2000	13	311	1

Table 2. Hi-ESP motor data (typical for AA coil)

Unit Size	Volts	RPM (Nominal)	CFM (Nominal)	Amps (FLA)	Watts	HP
75	115/60/1	1330	750	13	198	1
100	115/60/1	1330	1000	13	287	1
125	115/60/1	1330	1250	13	305	1
150	115/60/1	1330	1500	13	357	1
200	115/60/1	1200	2000	13	770	1

Grille Data

Table 3. Inlet grille free area

Unit Size	Horizontal Minimum Free Area	
	Outlet (in ²)	Inlet (in ²)
75	232	144
100	296	192
125	364	240
150 and 200	430	288

Coil Data

Table 4. Coil area

Unit Size	Length (in.)	Width (in.)	Face Area (in ²)
75	42	12	504
100	54	12	648
125	66	12	792
150	78	12	936
200	78	12	936

Table 5. Coil volume (gallons)

Coil Type	Unit Size	Volume (gal)
AA, AB	75	0.72
	100	0.85
	125	0.99
	150–200	1.57
AC	75	0.97
	100	1.17
	125	1.4
	150–200	2.27



General Data

Table 5. Coil volume (gallons) (continued)

AD and AE	75	1.25
	100	1.51
	125	1.8
	150–200	2.96
DA–DC	75	0.86
	100	0.98
	125	1.13
	150–200	1.71
DD–DE	75	1.11
	100	1.3
	125	1.53
	150–200	2.39
DK	75	0.97
	100	1.17
	125	1.39
	150–200	2.25
H1–H3	75	0.24
	100	0.3
	125	0.35
	150–200	0.68
H4–H6	75	0.72
	100	0.85
	125	0.99
	150–200	1.57
R1–R2	75	1.21
	100	1.47
	125	1.73
	150–200	2.94
X3–X6	75	0.97
	100	1.17
	125	0.99
	150–200	2.26

Hydronic Coils

Figure 11. Hydronic main coil

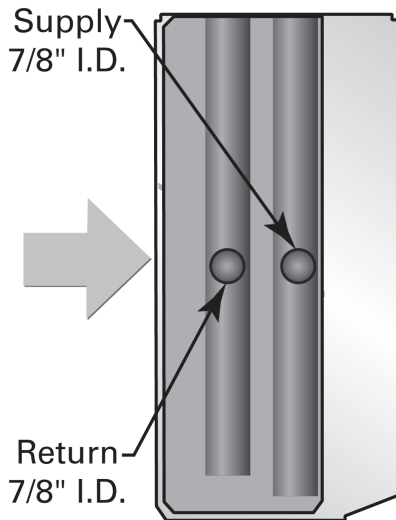

- Wavy plate finned.
- Hydrostatically tested at 350 psi.
- Piping packages for the main coil assembly are always supplied as a 3/4-inch package.

Coil type: AA, AB, AC, AD, AE, H1, H2, H3, H4, H5, H6, DA, DC, DD, DE, X3–X6, DK, R1, R2

Note: Left hand configuration shown.

Figure 12. Hydronic auxiliary coil

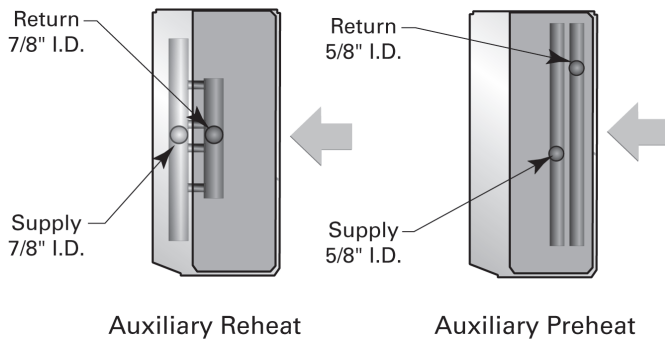

- Wavy plate finned.
 - Hydrostatically tested at 350 psi.
 - Piping packages for the main coil assembly are always supplied as a 3/4inch package.
- Coil type: DA, DC, DD, DE, R1, R2

Notes:

- Right-hand configuration shown.
- A manual air vent is provided on all hydronic coils. The vent allows air to be purged from the coil during start-up, or maintenance. The air vent is located on the return header. Similarly, a drain plug is located at the bottom of the MAIN coil return header.

Steam Coils

Figure 13. Steam main coil

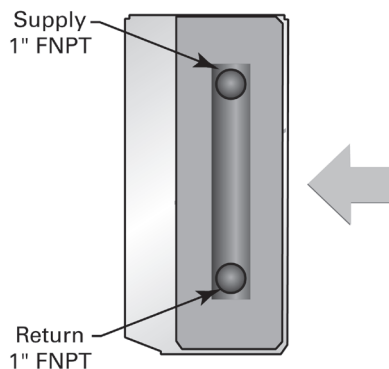

- 1-Row, tube-in-tube distributing coil
 - 1-inch socket pipe connection
- Piping packages for steam coils are field provided.
Coil type: K1, K2

Note: Right-hand configuration shown.

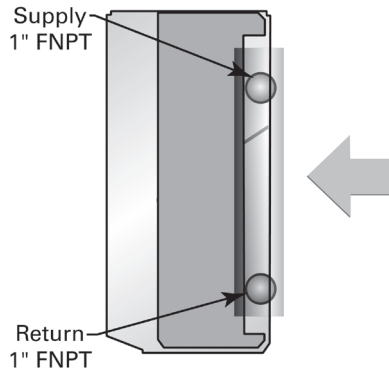
Figure 14. Steam auxiliary coil

- 1-Row, tube-in-tube distributing coil
 - 1-inch socket pipe connection
- Piping packages for steam coils are field provided. The modulating piping valve (option) is shipped loose and field installed.
Coil type: DK

Note: Right-hand configuration shown.

Electric Heat Coils

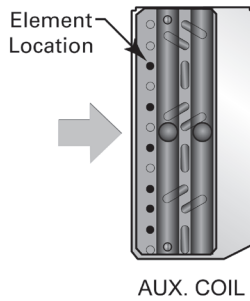
Figure 15. Electric heat coil

- Electric preheat coils consist of special resistance elements inserted in the coils fin surface for maximum element life, heat transfer and safety.
 - Units include both automatic reset and backup single-use, high temperature cut-outs with a continuous sensing element. These devices interrupt electrical power whenever excessive temperatures are sensed along either side of the coil.
 - Electric heat units include a panel interlock switch to disconnect power to the heating element when the access panel is opened.
 - Power connection is made in the right hand end pocket.
 - A circuit breaker option is available through the equipment model number.
- Coil Type: X3, X4, X6

DX Coils

- The direct expansion (DX) refrigerant coil includes a factory mounted adjustable thermal expansion valve (TXV) set to 90 psig superheat and an equalizing tube.
- 50 VA transformer
- Time delay relay
- Frost detection sensor
- Outside air sensor

Coil Type: G3, G0, GA, GK

Note: Available in a left-hand configuration only.

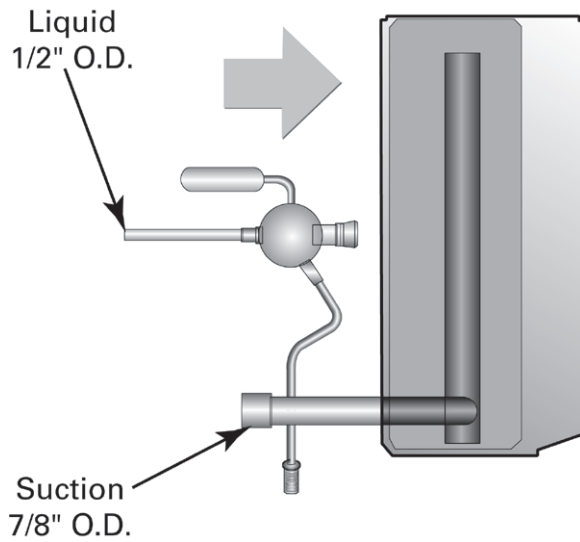
Figure 16. Direct-expansion (DX) coil

Table 6. Coil data

Style	Coil Type	Size	Type	Cooling		Heating	
				Rows	Fins/inch	Rows	Fins/inch
2-Pipe	Changeover Cool or Heat		AA	2	12	2	12
			AB	2	14	2	14
			AC	3	12	3	12
			AD	4	12	4	12
			AE	4	14	4	14
2-Pipe	Heating Only		H1	n/a	n/a	1	12
			H2	n/a	n/a	1	14
			H3	n/a	n/a	1	16
			H4	n/a	n/a	2	12
			H5	n/a	n/a	2	14
			H6	n/a	n/a	2	16
2-Pipe	DX Cooling Only	75	G0	2	12	n/a	n/a
		100	G0	2	12	n/a	n/a
		125	G0	2	12	n/a	n/a
		150	G0	2	12	n/a	n/a
		200	G0	2	14	n/a	n/a
2-Pipe	Steam Heating Only—Standard Capacity		K1	n/a	n/a	1	8
2-Pipe	Steam Heating Only—High Capacity	75	K2	n/a	n/a	1	10
		100	K2	n/a	n/a	1	13
		125	K2	n/a	n/a	1	10
		150	K2	n/a	n/a	1	14
		200	K2	n/a	n/a	1	14
4-Pipe	Cold Water Cool / Hot Water Heat		DA	2	12	1	12
			DC	2	14	1	14
			DD	3	12	1	12
			DE	3	14	1	14



General Data

Table 6. Coil data (continued)

Style	Coil Type	Size	Type	Cooling		Heating	
				Rows	Fins/inch	Rows	Fins/inch
4-Pipe	Cold Water Cool / Hot Water Re- Heat		R1	3	12	1	12
			R2	3	14	1	12
4-Pipe	Cold Water Cool / Steam Heating	75	DK	3	12	1	11
		100	DK	3	12	1	12
		125	DK	3	12	1	11
		150	DK	3	12	1	14
		200	DK	4	12	1	14
4-Pipe	Cold Water Cool / Electric Heating	75	X3-X6	3	12	Electric	
		100	X3-X6	3	12	Electric	
		125	X3-X6	2	14	Electric	
		150	X3-X6	3	12	Electric	
		200	X3-X6	3	14	Electric	
4-Pipe	DX Cool / Hot Water Heat	75	GA	2	12	1	12
		100	GA	2	12	1	12
		125	GA	2	12	1	12
		150	GA	2	12	1	12
		200	GA	2	14	1	12
4-Pipe	DX Cool / Steam Heating	75	GK	2	12	1	12
		100	GK	2	12	1	12
		125	GK	2	12	1	12
		150	GK	2	12	1	12
		200	GK	2	14	1	12
4-Pipe	DX Cool / Electric Heating	75	G3	2	12	Electric	
		100	G3	2	12	Electric	
		125	G3	2	12	Electric	
		150	G3	2	12	Electric	
		200	G3	2	14	Electric	

VRF Applications

The direct expansion (DX) refrigerant coils can be attached with an Electronic Expansion Valve (EXV) kit in the field. The coil will come without a thermal expansion valve to make this possible.

- 50 VA transformer
- Time Delay Relay
- Frost Detection Sensor
- Outside Air Sensor
- Coil Type: G3, G0, GA, GK

Note: Available in a left-hand configuration only.

Note: R-32 refrigerant is the only selection for this application.

Figure 17. HUV VRF coil

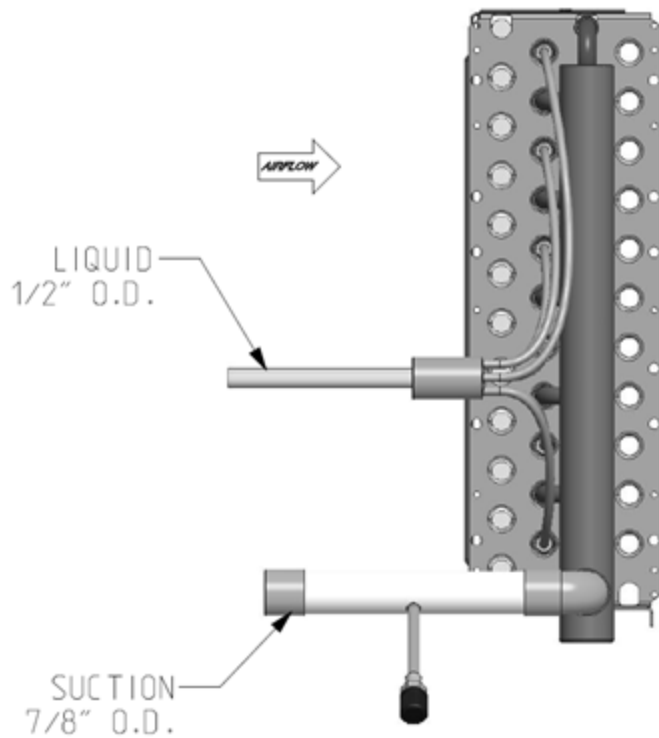

Controls Data

Table 7. Control methodology

	Fan Speed
CSTI	3 or infinite ^(a)
Symbio™ 400-B	Infinite

^(a) With a field-supplied 2–10 Vdc controller.

Table 8. Control sequences

	Fan Speed
DX operation ^(a)	1
Electric heat operation ^(a)	1

^(a) Fan speed during sequence operation.



Performance Data

Coil Performance

A Coils

AHRI Cooling performance is based on 80/67°F entering air temperature, 45°F entering chilled water temperature with a 10°F ΔT. Heating performance is based on 70°F entering air temp, 180°F entering water temperature with a 40°F ΔT. All performance measured on high speed tap, 115 V. Free discharge units: 0.0 ESP, with throwaway filter. High static units: 0.20 ESP, without filter.

Table 9. A-coils, 2-pipe coil with free discharge EC motor

Size	Coil Type	Airflow (cfm)	Cooling				Heating			Motor Power (W)
			Total Capacity (MBh)	Sensible Capacity (MBh)	Flow Rate (gpm)	WPD (ft H ₂ O)	Total Capacity (MBh)	Flow Rate (gpm)	WPD (ft H ₂ O)	
075	AA	875	19.12	15.62	3.81	1.49	52.00	2.60	0.70	135
	AB	825	21.80	16.49	4.34	1.88	57.80	2.89	0.80	135
	AC	815	27.63	19.28	5.51	4.09	63.90	3.19	1.40	135
	AD	780	21.13	16.70	4.21	0.67	67.20	3.36	0.40	135
	AE	760	19.64	15.28	3.91	0.59	71.70	3.58	0.50	135
100	AA	1090	25.18	9.02	5.02	2.89	67.00	3.35	1.20	180
	AB	1030	28.47	20.09	5.67	3.60	74.40	3.72	1.50	180
	AC	1025	33.88	22.89	6.75	7.02	81.90	4.09	2.50	180
	AD	975	30.23	21.17	6.02	1.49	96.60	4.33	0.70	180
	AE	1015	32.03	21.56	6.38	1.65	97.30	4.87	0.90	180
125	AA	1240	33.47	25.57	6.67	5.55	79.00	3.95	1.90	191
	AB	1300	40.07	28.39	7.99	7.64	94.40	4.75	2.70	191
	AC	1290	42.72	30.03	8.51	4.45	101.20	5.06	1.60	191
	AD	1240	46.56	31.33	9.28	3.66	110.70	5.54	1.30	191
	AE	1265	48.38	31.40	9.64	3.93	122.30	6.11	1.60	191
150	AA	1600	42.25	31.85	8.42	9.53	100.30	5.01	3.30	221
	AB	1525	46.68	32.38	9.30	11.38	112.10	5.60	4.10	221
	AC	1510	50.09	34.12	9.98	6.66	119.90	5.99	2.40	221
	AD	1600	56.11	36.64	11.18	5.70	141.80	7.09	2.30	221
	AE	1485	56.68	35.73	11.30	5.81	144.80	7.24	2.30	221
200	AA	2085	51.50	40.18	10.26	13.55	120.00	6.00	4.60	311
	AB	1985	58.90	42.59	11.74	17.21	135.40	6.77	5.70	311
	AC	1970	64.10	44.91	12.78	10.34	146.40	7.32	3.40	311
	AD	1885	71.18	47.35	14.19	8.78	161.70	8.08	2.90	311
	AE	1785	70.97	45.41	14.14	8.73	169.30	8.47	3.10	311

Table 10. A-coils, 2-pipe coil with high static EC motor

Size	Coil Type	Airflow (cfm)	Cooling				Heating			Motor Power (W)
			Total Capacity (MBh)	Sensible Capacity (MBh)	Flow Rate (gpm)	WPD (ft H ₂ O)	Total Capacity (MBh)	Flow Rate (gpm)	WPD (ft H ₂ O)	
075	AA	780	17.24	14.07	3.44	1.24	48.00	2.40	0.60	198
	AB	760	20.09	15.16	4.00	1.62	54.40	2.72	0.70	198
	AC	755	25.81	17.92	5.14	3.62	60.20	3.01	1.20	198
	AD	740	18.96	15.35	3.78	0.55	64.20	3.21	0.40	198
	AE	795	22.56	16.92	4.50	0.76	74.50	3.73	0.50	198
100	AA	1115	28.38	21.70	5.66	3.57	68.00	3.40	1.30	287
	AB	1090	32.67	23.42	6.51	4.59	77.50	3.88	1.60	287
	AC	1085	38.77	26.52	7.73	8.91	85.50	4.28	2.70	287
	AD	1055	37.26	25.97	7.43	2.17	92.40	4.62	0.80	287
	AE	1005	36.82	24.68	7.34	2.13	96.40	4.82	0.90	287
125	AA	1255	34.55	26.50	6.88	5.87	79.60	3.98	2.00	305
	AB	1225	39.67	28.07	7.91	7.51	90.40	4.52	2.50	305
	AC	1220	42.27	29.69	8.42	4.37	96.90	4.85	1.40	305
	AD	1350	51.35	34.70	10.23	4.38	118.70	5.93	1.50	305
	AE	1295	51.45	33.47	10.25	4.39	124.80	6.24	1.60	305
150	AA	1490	37.40	27.72	7.45	7.68	95.40	4.77	3.10	357
	AB	1450	42.55	29.09	8.48	9.65	108.00	5.40	3.80	357
	AC	1445	45.63	30.84	9.09	5.65	115.80	5.79	2.20	357
	AD	1715	55.74	36.38	11.11	5.63	150.00	7.50	2.50	357
	AE	1635	55.39	34.88	11.04	5.57	157.20	7.86	2.70	357
200	AA	2095	50.67	39.43	10.10	13.16	120.40	6.02	4.60	770
	AB	2005	57.94	41.78	11.55	16.71	136.40	6.82	5.80	770
	AC	1990	62.87	43.94	12.53	9.99	147.40	7.37	3.40	770
	AD	1895	69.14	45.88	13.78	8.32	162.40	8.12	2.90	770
	AE	1770	68.74	43.88	13.70	8.24	168.10	8.40	3.10	770

D Coils

AHRI Cooling performance is based on 80/67° F entering air temperature, 45°F entering chilled water temperature with a 10°F ΔT. Heating performance is based on 70°F entering air temp, 180°F entering water temperature with a 40°F ΔT. All performance measured on high speed tap, 115 V. Free discharge units: 0.0 ESP, with throwaway filter. High static units: 0.20 ESP, without filter.

Table 11. D-coils, 4-pipe with free discharge EC motor

Size	Coil Type	Airflow (cfm)	Cooling				Heating			Motor Power (W)
			Total Capacity (MBh)	Sensible Capacity (MBh)	Flow Rate (gpm)	WPD (ft H ₂ O)	Total Capacity (MBh)	Flow Rate (gpm)	WPD (ft H ₂ O)	
075	DA	815	18.16	14.82	3.62	1.36	51.20	2.56	0.50	135
	DC	780	19.20	14.93	3.83	1.50	56.70	2.83	0.70	135
	DD	780	26.73	18.60	5.33	3.85	49.70	2.48	0.50	135
	DE	760	26.81	18.21	5.34	3.87	55.60	2.78	0.60	135
100	DA	1025	24.21	18.20	4.83	2.70	66.30	3.32	1.00	180
	DC	975	24.95	17.96	4.97	2.84	73.00	3.65	1.20	180
	DD	975	32.41	21.82	6.46	6.49	64.00	3.20	0.90	180
	DE	1015	34.38	22.76	6.85	7.21	73.90	3.69	1.20	180



Performance Data

Table 11. D-coils, 4-pipe with free discharge EC motor (continued)

Size	Coil Type	Airflow (cfm)	Cooling				Heating			Motor Power (W)
			Total Capacity (MBh)	Sensible Capacity (MBh)	Flow Rate (gpm)	WPD (ft H ₂ O)	Total Capacity (MBh)	Flow Rate (gpm)	WPD (ft H ₂ O)	
125	DA	1290	34.12	26.13	6.80	5.74	84.00	4.20	1.70	191
	DC	1240	36.25	26.17	7.22	6.40	93.10	4.66	2.00	191
	DD	1240	41.81	29.35	8.33	4.46	81.60	4.08	1.60	191
	DE	1265	46.51	31.39	9.27	5.62	94.50	4.73	2.10	191
150	DA	1510	40.06	29.98	7.98	8.67	99.60	4.98	2.50	221
	DC	1600	43.37	30.73	8.64	9.98	118.60	5.93	3.40	221
	DD	1600	50.24	34.23	10.01	6.96	103.70	5.19	2.70	221
	DE	1485	54.23	35.59	10.81	8.28	112.30	5.61	3.10	221
200	DA	1970	49.82	38.66	9.93	12.77	119.80	5.99	3.50	311
	DC	1885	52.99	38.79	10.59	14.25	133.60	6.68	4.30	311
	DD	1885	62.56	43.67	12.47	10.31	116.20	5.81	3.30	311
	DE	1785	67.01	44.90	13.35	12.13	128.50	6.43	4.00	311

Table 12. D-coils, 4-pipe with high static EC motor

Size	Coil Type	Airflow (cfm)	Cooling				Heating			Motor Power (W)
			Total Capacity (MBh)	Sensible Capacity (MBh)	Flow Rate (gpm)	WPD (ft H ₂ O)	Total Capacity (MBh)	Flow Rate (gpm)	WPD (ft H ₂ O)	
075	DA	755	16.75	13.68	3.34	1.18	48.50	2.43	0.50	198
	DC	740	17.99	13.99	3.59	1.34	54.40	2.72	0.60	198
	DD	740	25.33	17.57	5.05	3.50	47.80	2.39	0.50	198
	DE	795	28.38	19.35	5.66	4.28	57.50	2.87	0.70	198
100	DA	1085	27.68	21.10	5.52	3.42	69.00	3.45	1.10	287
	DC	1055	29.55	21.60	5.89	3.84	77.40	3.87	1.30	287
	DD	1055	38.03	25.97	7.58	8.61	67.70	3.39	1.00	287
	DE	1005	38.15	25.45	7.60	8.66	73.30	3.66	1.20	287
125	DA	1220	33.80	25.85	6.74	5.65	80.70	4.03	1.50	305
	DC	1350	39.46	28.79	7.86	7.43	99.20	4.96	2.30	305
	DD	1350	45.76	32.35	9.12	5.24	86.70	4.34	1.80	305
	DE	1295	49.25	33.38	9.81	6.23	96.20	4.81	2.10	305
150	DA	1445	36.80	27.22	7.33	7.46	96.50	4.83	2.30	357
	DC	1715	43.12	30.52	8.59	9.88	124.80	6.24	3.80	357
	DD	1715	49.93	34.00	9.95	6.88	108.90	5.45	2.90	357
	DE	1635	53.07	34.77	10.58	7.97	120.60	6.03	3.50	357
200	DA	1990	48.96	37.88	9.76	12.38	120.60	6.03	3.50	770
	DC	1895	51.69	37.68	10.30	13.63	134.10	6.71	4.30	770
	DD	1895	60.89	42.37	12.14	9.82	116.70	5.83	3.30	770
	DE	1770	65.04	43.44	12.96	11.49	127.70	6.38	3.90	770

H, X Coils

AHRI Cooling performance is based on 80/67° F entering air temperature, 45° F entering chilled water temperature with a 10° F ΔT. Heating performance is based on 70° F entering air temp, 180° F entering water temperature with a 40° F ΔT. All performance measured on high speed tap, 115 V. Free discharge units: 0.0 ESP, with throwaway filter. High static units: 0.20 ESP, without filter.

Table 13. 2-Pipe coil, HW data

HUV Size	Coil Type	Heating		
		Total Capacity (MBh)	Flow Rate (gpm)	WPD (ft H ₂ O)
075	H1	41.18	2.06	2.85
	H2	45.12	2.26	3.36
	H3	48.74	2.44	3.86
	H4	53.49	2.67	0.7
	H5	57.95	2.90	0.81
	H6	61.84	3.09	0.91
100	H1	52.90	2.65	0.97
	H2	57.98	2.90	1.15
	H3	62.65	3.13	1.33
	H4	71.9	3.59	1.41
	H5	77.92	3.90	1.63
	H6	83.19	4.16	1.84
125	H1	66.45	3.32	1.67
	H2	72.85	3.64	1.98
	H3	78.73	3.94	2.28
	H4	90.36	4.52	2.45
	H5	97.97	4.90	2.83
	H6	104.61	5.23	3.19
150	H1	99.89	4.99	2.70
	H2	124.35	6.22	4.03
	H3	131.66	6.58	4.48
	H4	108.87	5.44	3.88
	H5	118.05	5.90	4.49
	H6	126.08	6.30	5.05
200	H1	120.35	6.02	3.80
	H2	152.05	7.60	5.84
	H3	161.68	8.08	6.54
	H4	132.52	6.63	5.52
	H5	144.37	7.22	6.44
	H6	154.87	7.74	7.32

Table 14. X-coils, 2-pipe with free discharge EC motor

Size	Coil Type	Cooling			
		Total Capacity (MBh)	Sensible Capacity (MBh)	Flow Rate (gpm)	WPD (ft H ₂ O)
075	X3	26.73	18.60	5.33	3.85
	X4	26.73	18.60	5.33	3.85
	X6	26.73	18.60	5.33	3.85
100	X3	32.41	21.82	6.46	6.49
	X4	32.41	21.82	6.46	6.49
	X6	32.41	21.82	6.46	6.49



Performance Data

Table 14. X-coils, 2-pipe with free discharge EC motor (continued)

Size	Coil Type	Cooling			
		Total Capacity (MBh)	Sensible Capacity (MBh)	Flow Rate (gpm)	WPD (ft H ₂ O)
125	X3	39.67	27.73	7.91	7.51
	X4	39.67	27.73	7.91	7.51
	X6	39.67	27.73	7.91	7.51
150	X3	50.24	34.23	10.01	6.96
	X4	50.24	34.23	10.01	6.96
	X6	50.24	34.23	10.01	6.96
200	X3	72.21	48.78	14.39	13.34
	X4	72.21	48.78	14.39	13.34
	X6	72.21	48.78	14.39	13.34

GA, DK, R1, R2 Coils

AHRI Cooling performance is based on 80/67 °F entering air temperature, 45°F entering chilled water temperature with a 10°F ΔT. Heating performance is based on 70°F entering air temp, 180°F entering water temperature with a 40°F ΔT. All performance measured on high speed tap, 115 V. Free discharge units: 0.0 ESP, with throwaway filter. High static units: 0.20 ESP, without filter.

Table 15. R1-, R2-, GA-coils, 4-pipe with free discharge EC motor, heating data

Unit Size	Coil Type	Heating		
		Total Capacity (MBh)	Flow Rate (gpm)	WPD (ft H ₂ O)
075	R1	30.38	1.52	1.66
	R2	36.27	1.81	2.29
	GA	53.61	2.68	0.59
100	R1	38.03	1.90	0.54
	R2	45.30	2.27	0.74
	GA	72.06	3.60	1.14
125	R1	48.31	2.42	0.94
	R2	57.62	2.88	1.30
	GA	90.57	4.53	1.91
150	R1	68.42	3.42	1.36
	R2	81.16	4.06	1.85
	GA	102.98	5.15	2.63
200	R1	81.33	4.07	1.86
	R2	96.80	4.84	2.56
	GA	136.30	6.81	4.45

Table 16. R1-, R2-, DK-coils, 4-pipe with free discharge EC motor, cooling data

Unit Size	Coil Type	Cooling			
		Total Capacity (MBh)	Sensible Capacity (MBh)	Flow Rate (gpm)	WPD (ft H ₂ O)
075	R1	26.73	18.60	5.33	3.85
	R2	26.81	18.21	5.34	3.87
	DK	17.47	13.97	3.48	1.27
100	R1	32.41	21.82	6.46	6.49
	R2	34.38	22.76	6.85	7.21
	DK	23.03	16.94	4.59	2.47
125	R1	41.81	29.35	8.33	4.46
	R2	46.51	31.39	9.27	5.40
	DK	33.47	24.34	6.67	5.55
150	R1	50.24	34.23	10.01	6.96
	R2	54.23	35.59	10.81	7.98
	DK	40.17	28.34	8.01	8.71
200	R1	62.56	43.67	12.47	10.31
	R2	67.07	44.90	13.35	11.67
	DK	48.70	35.47	9.71	12.26

DX Coils

Table 17. R-454B cooling only

HUV Unit Size	Suction Temperature	EWB (°F)	T-Btu/hr ^(a)	S-Btu/hr		
				EDB 72°F	EDB 76°F	EDB 80°F
075	40	63	18865	12052	15467	18574
	45	67	19919	7972	11532	15060
	50	71	21029	3638	7170	10878
100	40	63	24820	15965	20784	24543
	45	67	26117	10448	15251	19950
	50	71	27544	4735	9536	14353
125	40	63	30441	19769	25504	30266
	45	67	31903	12951	18875	24723
	50	71	33583	5690	11569	17730
150	40	63	36851	23892	31008	36531
	45	67	38641	15616	22735	29964
	50	71	40353	6867	14159	21323
200	40	63	43734	30169	38934	43734
	45	67	45733	19218	28689	38535
	50	71	47505	7509	17362	26976

Note: R-454B DX coils are rated at 95°F dry bulb/80°F wet bulb ambient outside air temperature, 25 feet of suction and liquid line, 400 cfm per Ton nominal.

^(a) Total Capacity calculated from outdoor 95°F dry bulb/80°F wet bulb and 80°F indoor DB standard air conditions.



Performance Data

Electric Heat Coils

Table 18. Electric heat capacity

Unit Size	Coil Type	No of Elements	Element kW	Total kW	TMBH
075	G3, X3	3	1.95	5.85	19.98
100	G3, X3	3	2.60	7.80	26.64
125	G3, X3	3	3.25	9.75	33.30
150	G3, X3	3	3.80	11.40	38.91
200	G3, X3	3	3.80	11.40	38.93

K1, K2 Steam Coils

Table 19. Steam coil capacity

Unit Size	Coil Type	EAT °F	TMBH				
			5 PSIG	10 PSIG	15 PSIG		
075	K1	-20	85.89	89.98	93.48		
		0	78.94	83.04	86.54		
		20	72	76.1	79.59		
		40	65.06	69.16	72.65		
		60	58.12	62.21	65.71		
		70	54.65	58.74	62.24		
	K2	-20	101.18	106.01	110.12		
		0	93.00	97.83	101.94		
		20	84.82	89.65	93.77		
		40	76.64	81.47	85.59		
		60	68.46	73.29	77.41		
		70	64.38	69.20	73.32		
		100	K1	-20	112.93	118.31	122.91
				0	103.80	109.19	113.78
20	94.67			100.06	104.65		
40	85.54			90.93	95.52		
60	76.41			81.80	86.40		
70	71.85			77.24	81.83		
K2	-20		158.08	165.61	172.05		
	0		145.30	152.84	159.27		
	20		132.52	140.06	146.49		
	40		119.74	127.28	133.71		
	60		106.96	114.50	120.93		
	70		100.57	108.11	114.55		

Table 19. Steam coil capacity (continued)

Unit Size	Coil Type	EAT °F	TMBH		
			5 PSIG	10 PSIG	15 PSIG
125	K1	-20	139.94	146.61	152.31
		0	128.63	135.30	140.99
		20	117.31	123.99	129.68
		40	106	112.68	118.37
		60	94.69	101.36	107.06
		70	89.03	95.71	101.40
	K2	-20	164.93	172.79	179.50
		0	151.60	159.46	166.17
		20	138.26	146.13	152.84
		40	131.78	132.8	139.51
		60	111.60	119.47	126.18
		70	104.93	112.80	119.51
150	K1	-20	166.93	174.89	181.68
		0	153.44	161.40	168.19
		20	139.94	147.9	154.7
		40	126.45	134.41	141.2
		60	112.96	120.92	127.71
		70	106.21	114.17	120.96
	K2	-20	243.70	256.14	263.74
		0	224.72	236.38	246.33
		20	204.96	216.62	226.57
		40	185.2	196.86	206.8
		60	165.43	177.09	187.04
		70	155.55	167.21	177.16
200	K2	-20	286.51	306.05	317.93
		0	266.20	282.43	294.32
		20	244.09	258.82	270.71
		40	221.28	235.21	274.09
		60	197.66	211.59	223.48
		70	185.86	199.79	211.67

Notes:

1. Condensate trap for the steam coil option is field installed.
2. Static pressure for the K1, K2 options should be modeled after the H1 coil option.
3. Steam coils that function at 5 psig or less should not utilize valve control. Valve control may starve the coil, causing stratification.



Performance Data

DK, GK Steam Coils

Figure 18. DK, GK Steam coils performance data

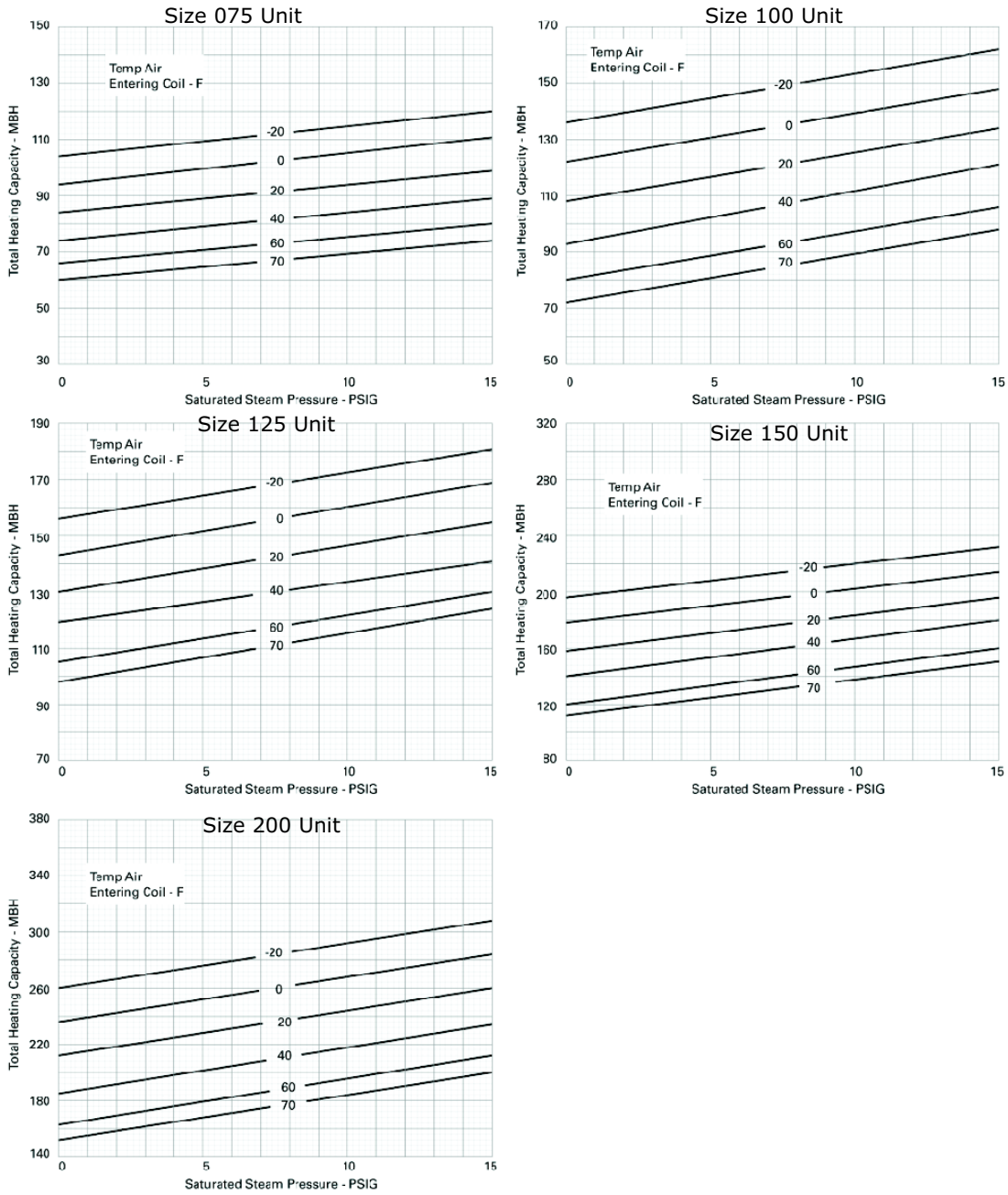



Controls

Why Trane Controls?

Whether involved in a retrofit or in new construction applications, Trane has the control design to fit the systems requirements. Trane offers a broad range of control packages from a field convertible end-device package, to a complete building automation system solution with BACnet® controls.

Note: Factory addressing is available for Symbio™ 400-B and Air-Fi® WCI controller types. This option allows configuration of units before delivery, reducing the field setup time.

Trane controls are factory-mounted, -wired, -tested and configured or programmed with Trane application expertise to provide comfort, efficiency, and reliability, as well as single-source warranty and service. With Trane integrated controls, the installed costs are lower because the equipment has turn-key factory controls and every component of the system is optimized to fit with the controller. Trane installs not only the controller, but also the hardware that works intimately with the controller to allow the system to function properly (i.e., piping package, valves, dampers, actuators, etc.). When a product with Trane controls arrives on the jobsite, it is completely ready for quick installation.

Table 20. Tracer® controller input/output summary

	Symbio™ 400-B
Binary outputs	
Single zone VAV	X
3-speed fan	
2-position hydronic valve	X
2-position mixing box damper	X
1-stage electric heat	X
Modulating mixed air damper	X
Modulating hydronic valve	X
2-stage electric heat	X
Reheat (hydronic)	X
Generic	X
Binary inputs	
Condensate overflow detection	X
Low temperature detection	X
Occupancy	X
Generic input	X
Analog inputs	
Zone temperature	X
Setpoint	X
Fan mode: auto, high, medium, low	X
Entering water	X
Discharge air	X
Outside air	X
Generic	X

Table 20. Tracer® controller input/output summary (continued)

	Symbio™ 400-B
Analog outputs	
Analog hydronic valve	X

Table 21. Tracer® controller function summary

Control Function	Symbio™ 400-B
Entering water temp. sampling (purge)	X
Timed override	X
Auto changeover	X
Fan cycling	X
Warm-up	X
Pre-cool	X
Data sharing (client/server)	
Random start	X
Dehumidification	X
Staged capacity (2-stage electric supplementary)	X
DX cooling	X
Air-Fi® factory addressing	X
Other Functions	
Manual test	X
Filter maintenance timer	X
Setpoint limits	X

VelociTach™ Motor Control Board

The VelociTach motor control board controls and reports the performance of up to two Trane brushless DC (BLDC) motors.

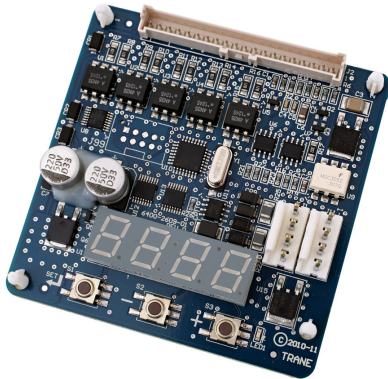
Figure 19. VelociTach motor control board

The motor control board also:

- Coordinates the operation of the fan in response to electric heat behavior and electric behavior in response to hydronic heat behavior.

- Incorporates a user interface that allows adjustment of certain unit parameters and provides constant feedback on motor operation.
- Integrates service and troubleshooting tools.
- Integrates a versatile configurable auxiliary temperature sensor.
- Incorporates various safety and lockout features, such as maintaining proper fan speeds if electric heat is called for.

Status Display

Figure 20. Status display

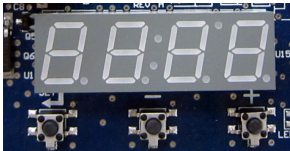

The motor control board contains a four-digit, seven-segment display that is used to present information in a format close to real-world language, while having a small-form factor. Most characters are immediately recognizable.

Control Options

Available control options:

- Customer-supplied terminal interface (CSTI)
- Symbio™ 400-B controller with Air-Fi® Wireless Communications Interface

Control option descriptions follow. A complete list of controller inputs and outputs are in [Table 20, p. 37](#).

Customer Supplied Terminal Interface (CSTI)

The CSTI is intended to be used with a field-supplied, low-voltage thermostat or controller. The control box contains a relay board which includes a line voltage to 24-volt transformer and disconnect switch (for non-electric heat units). All end devices are wired to a low-voltage terminal block and are run-tested, so the only a power connection and thermostat connection is needed to commission the unit. Changeover sensors and controls are provided whenever a change-over coil is selected. When N.O. valves are selected, inverting relays are provided for use with standard thermostats.

The CSTI adapter board provides all the hookups as the standard adapter board, but in addition, provides hookups for valve control (main and pre-heat or re-heat), electric heat control, and damper control. Screw terminal blocks provide convenient access to fan controls and to end device control. In addition, a courtesy 10-Vdc supply is provided for use with an external potentiometer or rheostat. The 10-Vdc supply supports up to 10 mA draw.

Tracer® Controllers

Symbio™ 400-B Controller

Figure 21. Tracer controller

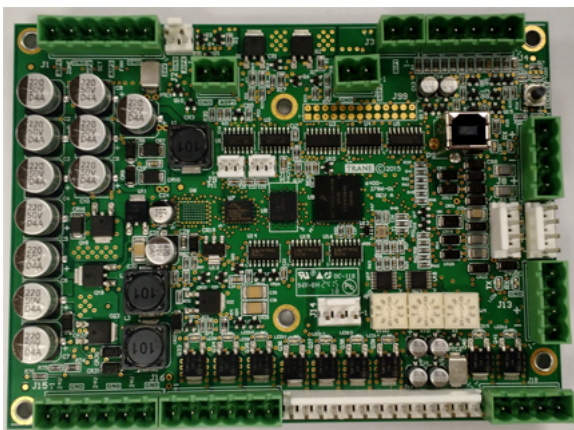



Controls

The Tracer single-zone VAV controller can be used in a stand-alone application or as part of a Tracer control system.

In the stand-alone configuration, Tracer receives operation commands from the zone sensor and/or the entering water temperature sensor (on auto changeover units). The entering water temperature sensor reading determines if the unit is capable of cooling or heating. The zone sensor module is capable of transmitting the following information to the controller:

- Timed override on/cancel request
- Zone setpoint
- Current zone temperature
- Fan mode selection (off-auto-high-med-low)

For optimal system performance, units can operate as part of a Tracer SC building automation system. The controller is linked directly to the Tracer SC via a twisted pair communication wire, requiring no additional interface device (i.e., a command unit). The Tracer control system can monitor or override Tracer control points. This includes such points as temperature and output positions.

Tracer control points. This includes such points as temperature and output positions. The Symbio 400/Symbio 400-B is a multi-purpose, programmable (or application-specific) controller that provides direct-digital zone temperature control. The controller can operate as a stand-alone device or as part of a building automation system (BAS). Communication between the controller and a BAS occurs on an open standard with inter-operable protocols used in Building Automation and Control Networks (BACnet®). Programming is done by means of the Tracer TU service tool.

Tracer® Controller Features

The Tracer family of controllers offer the combined advantages of simple and dependable operation with the latest Trane-designed controller. Standard control features include options normally available on more elaborate control systems. All control options are available factory-configured or can be field-configured using Tracer TU service software. For more detailed information, see the associated installation, operation, and maintenance manual:

- Tracer UC400 Programmable Controllers For Blower Coil, Fan Coil, and Unit Ventilator Installation, Operation, and Maintenance (BAS-SVX48*-EN)
- Symbio™ 400-B/500 Programmable Controllers For Blower Coil, Fan Coil, and Unit Ventilator Installation, Operation, and Maintenance (BAS-SVX093*-EN)

Features Available on All Trane Tracer® Controllers

The following control functions are standard features on units with Tracer controllers.

Entering Water Temperature Sampling Function

A system that uses a two-way control valve option might not sense the correct entering water temperature during long periods when the control valve is closed. If the demand for heating or cooling does not exist for a long period, the entering water will eventually approach ambient temperature.

Using the entering water temperature sampling function, the controller provides accurate two-pipe system changeover-without sacrificing the benefits of two-way control valves. Also, it eliminates inefficient bleed or bypass lines that can allow unnecessary waterflow through the system.

This function periodically samples the entering water temperature by opening the hydronic valve. The valve opens for 20 seconds to allow the water temperature to stabilize. Then the controller reads the entering water temperature for up to three minutes to see if the correct water temperature is available for the selected operating mode.

The entering water temperature must be five degrees or more above the space temperature to allow hydronic heating and five degrees or more below the space temperature to allow hydronic cooling. If the correct water temperature for the operating mode is available, the unit begins normal heating or cooling operation. If the correct water temperature is not available, the controller closes the control valve and waits 60 minutes before attempting to sample the entering water temperature again.

A factory-mounted thermistor senses the entering water temperature on changeover cooling/ heating coil units. If the fan coil has a factory-mounted piping package, the sensor is strapped to the entering water pipe. If the fan coil does not have a piping package, the sensor is coiled in the end pocket for mounting on customer-supplied piping. This sensor must detect accurate water temperature for proper changeover.

Automatic Heat/Cool Mode Determination

The controller automatically determines whether heating or cooling is needed-based on space and system conditions. Using a proportional/integral (PI) control algorithm to maintain the space temperature at the active heating or cooling setpoint. The

controller measures the space temperature and active setpoint temperature to determine the unit's heating or cooling capacity (0 to 100 percent).

Occupied/Unoccupied Operation

The occupancy input uses a binary switch (i.e., motion sensor, time clock, etc.) that allows the zone sensor to use its unoccupied internal setpoints.

Random Start

This feature randomly staggers multiple unit start-up to reduce electrical demand spikes.

Warm-up

The two-position fresh air damper option closes during the occupied mode when the space temperature is three degrees or more below the heating setpoint temperature. The damper remains closed during warm-up until the space temperature is within two degrees of the heating setpoint temperature.

Cool-down

The two-position fresh air damper option closes during the occupied mode when the space temperature is three degrees or more above the cooling setpoint temperature. The damper remains closed during cooldown until the space temperature is within two degrees of the cooling setpoint temperature.

Manual Output Test

This function may be initiated from the blue test push button on the controller or through the Tracer® TU service tool. This feature is used to manually exercise the outputs in a defined sequence.

The purpose of this test sequence is to verify output and end device operation. The manual output test function may also be used in the following situations:

- Reset latching diagnostics
- Verify output wiring and operation
- Force the water valve(s) open to balance the hydronic system during installation set-up or service.

Peer-to-Peer Communication (Symbio™ 400-B)

Peer-to-peer communication allows multiple units in one space to share the same zone sensor and provide simultaneous heating and cooling. On the Symbio 400-B, zone sensor data sharing can be accomplished by use of the BAS system controller.

A thermistor to sense fresh air is factory-mounted at the unit's fresh air opening for use in economizer applications or as a read-only point for Tracer® SC. If the fresh air temperature is a read-only value, it will not impact the control algorithm. In an economizer application, a fresh air temperature signal must be provided either by this thermistor, Tracer SC.

Additional Features

Single Zone VAV with Fully Modulating Fan Speed (Symbio™ 400-B)

The Symbio 400-B will minimize fan speed, and in turn energy usage, by only delivering the air flow needed.

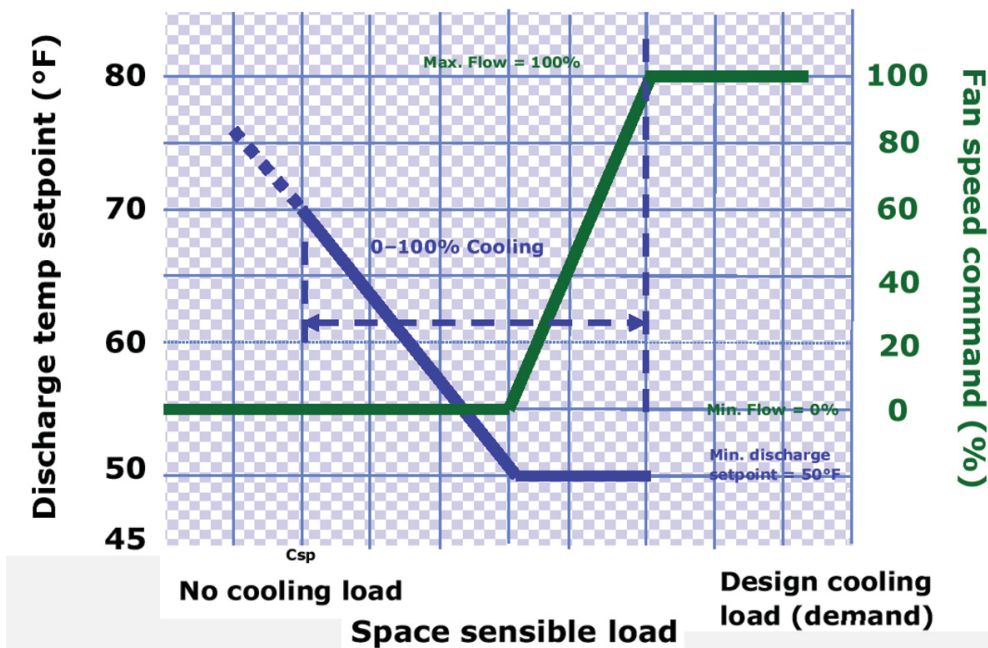
Figure 22. Cool mode nominal hydronic cooling control

Single-zone VAV control: Single-zone VAV control varies the speed of the EC fan motor as the zone cooling or heating load changes. When the zone is at design cooling load, the unit operates the fan at maximum speed and cooling capacity is modulated or cycled to deliver the air at the design discharge air temperature (DAT) setpoint for cooling. As the zone cooling load decreases, fan speed is reduced to maintain zone temperature at cooling setpoint, while cooling capacity (and/or economizer) is modulated or cycled to maintain DAT at the same design setpoint. When the fan has reached minimum speed, and the zone cooling load continues to decrease, the fan continues to operate at minimum speed while the DAT setpoint begins to reset upward to maintain zone temperature at cooling setpoint. Cooling capacity (and/or economizer) is modulated or cycled to maintain this DAT setpoint.

When the zone temperature drops to heating setpoint, the fan continues to operate at minimum speed and the DAT setpoint is reset further upward. Heating capacity is modulated or staged to maintain this DAT setpoint. If the zone heating load increases to the point where DAT reaches the maximum limit, fan speed is again increased, while heating capacity is modulated or staged to maintain DAT at this maximum limit.

Automatic Fan and Ventilation Reset

A two-speed fan control for the unit delivers the airflow output customized to support the cfm space needs. When less cfm is necessary to meet the load of the classroom (typically 75 to 80 percent of the time), the equipment operates on low speed. However, if the room temperature rises, the controller will switch to high speed, and the outside air damper will adjust to satisfy the space needs. This helps maintain the proper amount of ventilation air to the occupants independent of the fan speed. As part of the ventilation strategy, the controller will reposition the outside air damper to confirm the minimum outside air cfm is met at both operating conditions.

Filter Maintenance

Filter status for the controller is based on the cumulative run hours of the unit fan. The controller compares the amount of fan run time against an adjustable fan run hour (stored in the controller) to determine when maintenance is recommended for the unit. The run-hours value may be user edited as required (through Tracer® TU). The valid range for the fan run hours limit is 0 to 5000 hours with a default of 600 hours. Once the run hours limit has been exceeded, the controller generates a maintenance required diagnostic (unit will not shut-down). The user will be notified of this diagnostic through the building automation system or when a Trane service tool is communicating with the controller.

Active Dehumidification

On units with reheat coils, the controller can provide active dehumidification. This means that the relative humidity in the space can be kept below an adjustable setpoint independent of outdoor weather conditions. Indoor humidity levels are recommended

by ASHRAE to be kept below 60 percent in order to minimize microbial growth and the life span of airborne illness causing germs.

Client Server (Data Sharing)

The controller can send or receive data (setpoint, heat/cool mode, fan request, space temperature, etc.) to and from other controllers on the communication link with or without the existence of a building automation system. This applies to applications where multiple units might share one zone sensor for both stand-alone (with communication wiring between units) and a building automation system.

Figure 23. Client server system layout

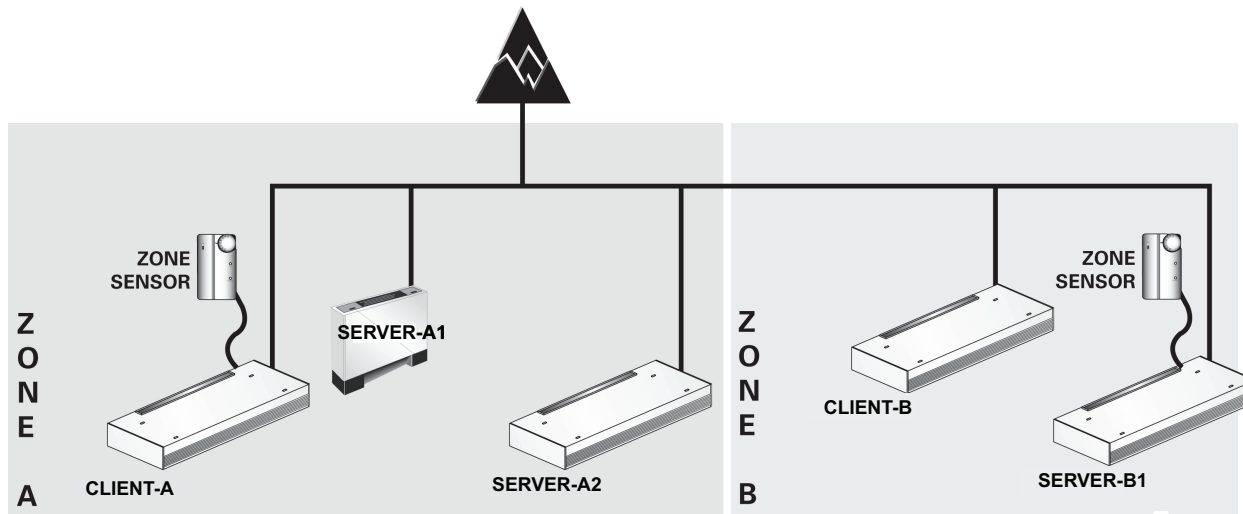

Water Valve Override

The controller can be commanded via Tracer® TU to open all hydronic valves 100 percent. This allows for the faster water balancing of each unit and the entire system when the command is sent globally to all controllers. A properly balanced system is essential for proper and efficient operation.

Hydronic Coil Freeze Protection (Freeze Avoidance)

Systems in cold climates need to take precautions to avoid hydronic coil freeze-up. The controller does this from three different aspects. Any of these methods of protections will result in the unit fan being disabled, the outside air damper being shut, and the hydronic valves being opened 100 percent. The three methods of freeze avoidance include:

1. A binary freeze protection thermostat is mounted on the coil and will cause a latching diagnostic if the coil temperature falls below 35°F.

Note: Units with R-454B or R-32 refrigerant will not have a binary freeze protection mounted to the coil. These units will rely on the binary freeze protection on the DX coil and protection methods 2 and 3.

2. An analog discharge air sensor monitors the temperature of the air coming off of the coil and if the temperature falls below 40°F the outside air damper is closed, the fan is turned off and the valves are fully opened.
3. When in the unoccupied mode, the controller has an adjustable freeze avoidance setpoint. If the outside air temperature is below the setpoint, the unit will open the valves to allow water to flow through the coils.

Interoperability

Inter-operability allows the owner freedom to select multiple vendors, and multiple products. With this advantage, the owner can choose the best products, the best application, and the best service from a variety of suppliers to meet their evolving building control needs in a cost effective manner.

Generic Binary Input/Output

The three generic binary inputs/outputs are not part of the normal control, but are actually controlled through the Tracer® SC system (when present) to issue commands to the controller to turn the generic inputs/outputs of add-on equipment (such as baseboard heating, exhaust fans, occupancy sensors, lighting, etc.) on and off. This binary port is not affected when other binary diagnostics interrupt unit operation.



Tracer® Controls Sequence of Operation

Symbio™ 400-B

Off: Fan is off; control valve options and mixing box damper options close. The low air temperature detection option is still active.

Auto: Fan speed control in the auto setting allows the modulating control valve option and single- or threespeed fan to work cooperatively to meet precise capacity requirements, while minimizing fan speed (motor/energy/acoustics) and valve position (pump energy/chilled water reset). As the capacity requirement increases at low fan speed, the water valve opens. When the low fan speed capacity switch point is reached, the fan switches to the next higher speed and the water valve repositions to maintain an equivalent capacity. The reverse sequence takes place with a decrease in required capacity.

Units with three-speed fans on low, medium, or high: The fan runs continuously at the selected speed and the valve option cycles to meet setpoint.

Air-Fi® Wireless Systems

For more detailed information on Air-Fi® Wireless systems and devices, see:

- BAS-SVX40*-EN: Air-Fi® Wireless Installation, Operation, and Maintenance
- BAS-PRD021*-EN: Air-Fi® Wireless Product Data Sheet
- BAS-SVX55*-EN: Air-Fi® Wireless Network Design

Air-Fi® Wireless Communications Interface (WCI)



A factory-installed Air-Fi® Wireless Communications Interface (WCI) provides wireless communication between the Tracer® SC and Tracer® unit controllers. The Air-Fi® WCI is the perfect alternative to a Trane BACnet® wired communication link. Eliminating the communication wire between terminal products, space sensors, and system controllers has substantial benefits:

- Reduced installation time and associated risks.
- Completion of projects with fewer disruptions.
- Easier and more cost-effective re-configurations, expansions, and upgrades.

Air-Fi® Wireless Communications Sensor (WCS)



Communicates wirelessly to a Tracer® unit controller. A WCS is an alternative to a wired sensor when access and routing of communication cable are issues. A WCS allows flexible mounting and relocation.

Wireless Zone Sensor (WZS) Set



A wireless zone sensor (WZS) set (sensor and receiver) communicates wirelessly to a Tracer® unit controller. A wireless zone sensor set is an alternative to a wired sensor when access and routing of communication cable are issues. The sensor allows flexible mounting and relocation.

Note: A wireless zone sensor set is not compatible with an Air-Fi® wireless system.

Zone Sensor Options

Zone sensor options are available as either unit-mounted (factory-installed), wall-mounted, or splitmounted options for design flexibility. The unit-mounted sensor option includes a thermistor in the unit's return air path. Wall-mounted zone sensor options have an internal thermistor. Zone sensors operate on 24 Vac. Options with setpoint knobs are available in Fahrenheit or Celsius.

Controls

Figure 24. Wireless temperature sensor with display (SP, OALMH)



Figure 25. Wireless temperature sensor (SP, OCC/UNOCC)



Figure 26. Wall-mounted temperature sensor (SP, OCC/UNOCC, OALMH)



Figure 27. Unit-mounted temperature sensor (SP, OALMH)



Figure 28. Split-mtd zone sensor - unit-mtd fan speed control, wall-mtd setpoint dial (OCC/UNOCC)



Figure 29. Split-mtd zone sensor - unit-mtd fan speed control, wall-mtd setpoint dial



Figure 30. Wall-mounted temperature sensor (SP, OALMH)



Figure 31. Wall-mounted display temperature sensor (SP, OCC/UNOCC, OALMH)



Figure 32. Air-Fi® Wireless Communications Sensor (WCS-Symbio™ 400-B only) (SP, OALMH)



End Device Options

Actuators

Face-and-bypass actuator specification



Power Supply	24 Vac ± 20% 50/60 Hz
	24 Vac ± 10%
Power Consumption	2 W
Transformer Sizing	3 VA (class 2-power source)
Angle of Rotation	Maximum 95°
	Adjustable with mechanical stop
Torque	35 inch/lb
Direction of Rotation	Reversible with switch L/R
Position Indication	Clip-on indicator
Manual Override	External push button
Noise Level	Less than 35 dB
Control Signal	3-point floating

Outside air actuator specification



Power Supply	24 Vac ± 20% 50/60 HZ
	24 Vac ± 10%
Power Consumption	Running: 2.5 W
	Holding: 1 W
Transformer Sizing	5 VA (class 2-power source)
Overload Protection	Electronic throughout 0° to 95° rotation
Control Signal	2 to 10 Vdc
	3-point floating with Trane controls
Angle of Rotation	Maximum 95°
	Adjustable with mechanical stop
Torque	35 inch/lb
Direction of Rotation	Spring return reversible with CW/CCW mounting
Position Indication	Visual indicator, 0° to 95°
Noise Level	Running: 30 dB



Electrical Data

Table 22. Full load amps (FLA) for standard EC motors

Unit size	HP	Volts	Amps
750, 1000, 1250, 1500, 2000	1	120	12.00
		208	7.05
		240	6.45
		277	5.25

Note: For standard EC motors, FLA is the same for high static and free discharge motors.

Table 23. Full load amps (FLA) for low FLA EC motors

Unit size	Motor Type	Motor FLA with 115 V motor	Motor FLA with 208 V motor	Motor FLA with 240 V motor	Motor FLA with 277 V motor
750, 1000, 1250, 1500	Free discharge	2.7	1.6	1.4	1.3

Table 24. Minimum circuit ampacity (MCA) for electric heat coils with standard EC motors

Unit Size	No. of Elements	Coil kW	Unit MCA					
			208V 1ph	240V 1ph	277V 1ph	208V 3ph	240V 3ph	480V 3ph
750	3	5.85	43.98	38.54	32.96	29.14	25.68	15.37
1000		7.80	55.69	48.69	41.76	35.91	31.55	18.30
1250		9.75	67.41	58.85	50.56	42.69	37.41	21.24
1500		11.40	77.33	67.44	58.01	48.41	42.39	23.72
2000		11.40	77.33	67.44	58.01	48.41	42.39	23.72

Note: Electric heat is not allowed with 115V units. For standard EC motors, MCA is the same for high static and free discharge motors.

Table 25. Minimum circuit ampacity (MCA) for electric heat coils with low FLA free discharge motors

Unit Size	No. of Elements	Coil kW	Unit MCA					
			208V 1ph	240V 1ph	277V 1ph	208V 3ph	240V 3ph	480V 3ph
750	3	5.85	37.16	32.22	28.02	22.32	19.36	10.43
1000		7.80	48.88	42.38	36.82	29.10	25.23	13.37
1250		9.75	60.59	52.53	45.62	35.87	31.10	16.30
1500		11.40	70.51	61.13	53.07	41.60	36.07	18.79

Note: Electric heat is not allowed with 115V units. Motor high rpm cannot be increased to beyond factory programmed value for low FLA units.

Electrical Data

Equations:

Minimum circuit ampacity (MCA) and maximum overcurrent protection (MOP) calculations for unit ventilators with electric heat (single phase) heater amps = (Heater kW x 1000)/heater voltage.

Note: Use 120V heater voltage for 115V units. Use 240V heater voltage for 230V units.

MCA = 1.25 x (heater amps + all motor FLAs)

MOP = (2.25 x largest motor FLA) + Heater amps (if applicable)

The minimum value for the protective device is 15 A. If the calculated value for the protective device equals or exceeds 20 then the protective device size selected is the closest standard size which does not exceed the calculated value.

If the selected size is less than 1.25 times the heater amps then the next larger size may be selected.

If the calculated value is less than the MCA then the next larger size may be selected.

Standard sizes are: 15, 20, 25, 30, 35, 40, 45, 50, 60 amps (increase to 150 amps)

Unit ventilator electric heat MBh = (Heater kW) (3.413)

Figure 33. Electric heat

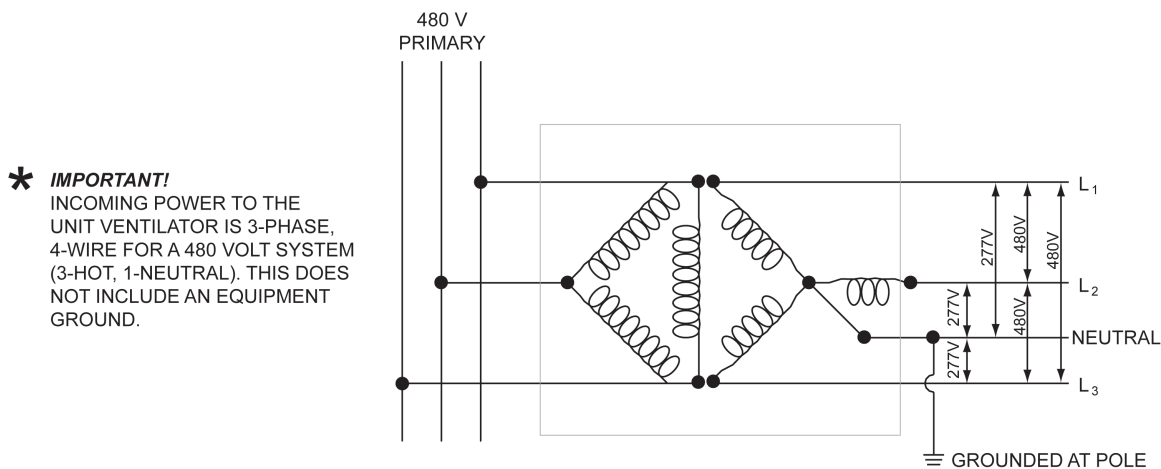

Note: Incoming power to the unit ventilator is 3-phase, 4-wire for a 480 volt system (3-hot, 1-neutral). This does not include an equipment ground.



Acoustical Data

Table 26. Horizontal octave band sound power ratings (sound power in dB ref: 10⁻¹² watts)

Octave Band Center of Frequency	1 63	2 125	3 250	4 500	5 1000	6 2000	7 4000	8 8000
075 High Speed	66	67	61	60	56	53	48	41
075 Med Speed	62	63	57	56	52	49	44	37
075 Low Speed	59	60	54	53	49	46	41	34
100 High Speed	66	67	61	60	56	52	48	41
100 Med Speed	62	63	57	56	52	48	44	37
100 Low Speed	59	61	55	54	43	45	38	29
120 High Speed	70	71	65	64	60	56	51	44
120 Med Speed	66	67	61	60	56	52	47	40
120 Low Speed	63	64	58	57	53	49	44	37
150 High Speed	65	68	62	60	56	52	45	38
150 Med Speed	61	64	58	56	52	48	41	34
150 Low Speed	57	63	54	53	47	42	33	25
200 High Speed	73	75	68	64	60	57	53	45
200 Med Speed	67	69	62	58	54	51	47	39
200 Low Speed	64	74	59	60	49	45	37	29

The preceding table reflects sound power ratings for the horizontal classroom unit ventilator. To calculate the noise criteria (NC) for a unit, subtract the actual room effect from the sound power number in each octave band. These numbers may be graphed on a NC chart.

Note: Request exact numbers per the specific job from the design engineer in order to validate acoustical data. By obtaining these exact numbers, the most accurate results of the installed unit may be calculated.

Data obtained in the reverberant rooms conform to ANSI S12.31 and ANSI S12.32

Piping

Factory-Installed Piping Packages

Piping package options are available with Symbio™ 400-B controllers or CSTI. Field connections are brought to a point near the exterior of the unit for quick hook-up. Insulation of the factory piping package is required.

Piping Package Components

Control valves are mounted in all piping packages. All piping packages are factory installed and come in a variety of options:

- **Basic:** Union and shut-off ball valve on the supply line. Union, control valve and shut-off ball valve on the return line.
- **Basic with manual circuit setter:** Union, shut-off ball valve on the supply line. Union, control valve and manual circuit setter on the return line.
- **Deluxe with manual circuit setter:** Union, strainer, P/T port, and shut-off ball valve on the supply line. Union, control valve and manual circuit setter on the return line.
- **Deluxe with auto flow:** Union, strainer, P/T port, and shut-off ball valve on the supply line. Union, control valve, auto flow valve, P/T port and shut-off ball valve on the return line.

Factory piping packages are available for either two or four-pipe systems with right or left hand connections.

Figure 34. Basic piping package

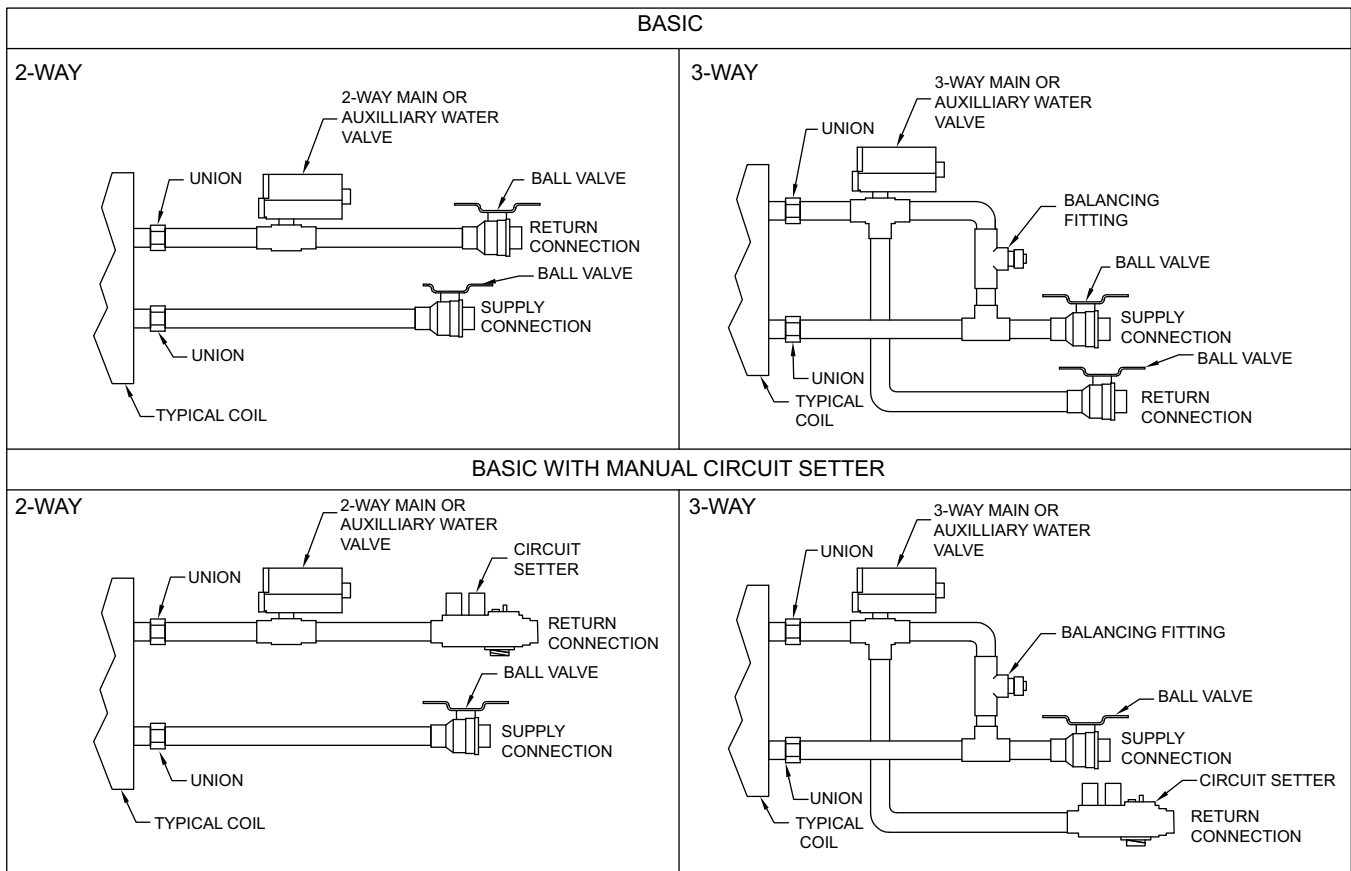
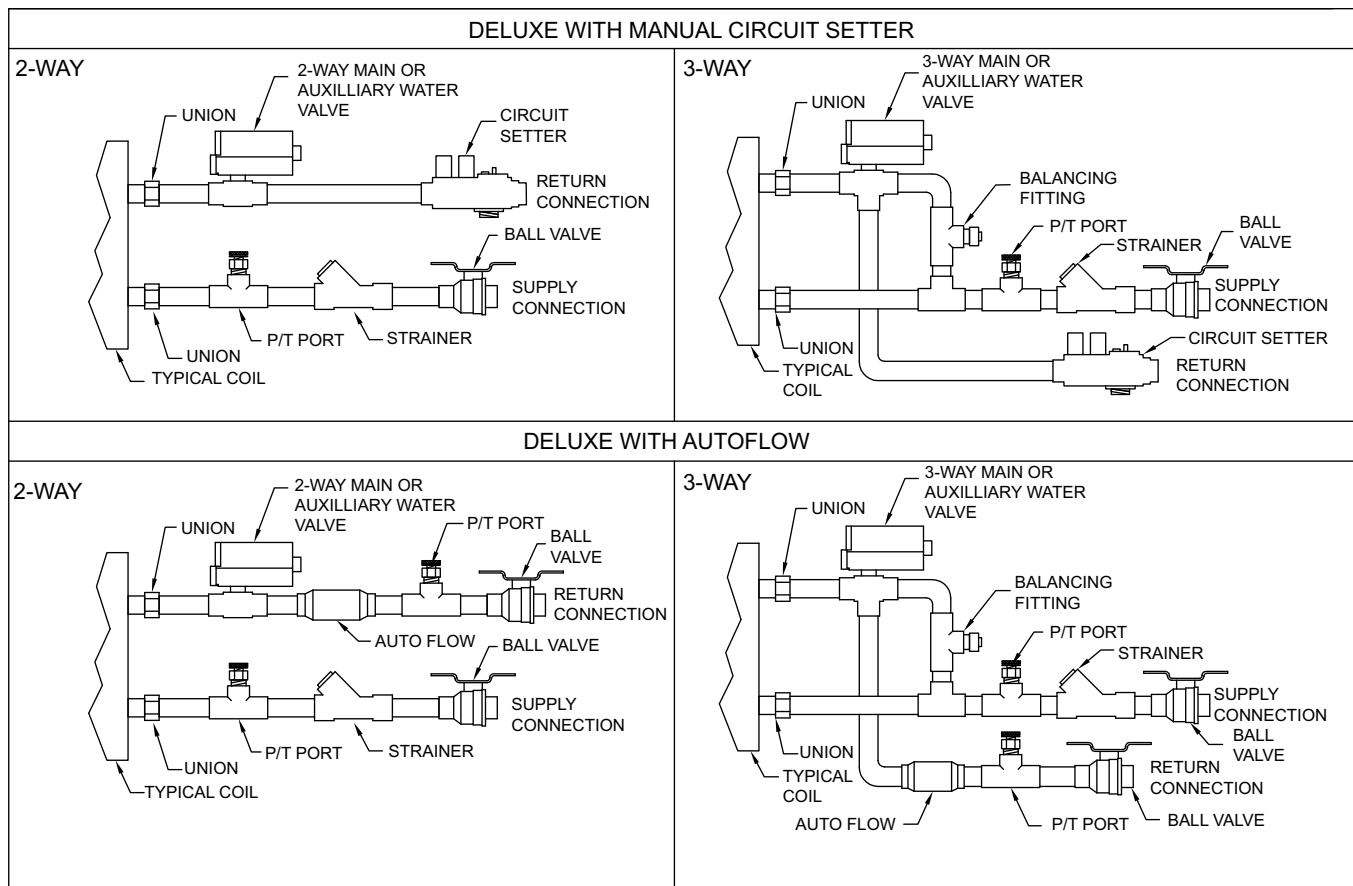

Figure 35. Deluxe piping package



Control Valves

Units with CSTI or any of the Tracer® controllers (Symbio™ 400-B) are available with chilled and/or hot water control valves. Control valve options include:

- Analog (2 to 10 Vdc)
- Modulating
- Two-position, normally-open (N.O.) or normally-closed (N.C.)
- Two- or three-way configurations

See the valve availability table for a complete list of valve options by size.

Three-way valve options allow either full water flow through the coil or diverted water flow through the bypass.

Two-Position Control Valves

Two-position valve options are spring-return or capacitor discharge-return types. Valves respond to a 24V signal and will either fully open or close. These valves cannot be driven or actuated to a partially open or closed position. If the valve loses power, the valve returns to its de-energized position.

Modulating and 2 to 10 Vdc Analog Control Valves

Modulating and 2 to 10 Vdc Analog control valves offer an alternative for more precise capacity control. Modulating valves respond to a 24 V signal from the controller, which determines the valve position by a control algorithm. Analog valves travel to the commanded position of the 2 to 10 Vdc control signal. If the valve loses power, it remains in its current position.

Field-Supplied Valves

This option allows the controller to be factory-configured for the normal position of the field supplied valve. A valve wire harness is provided from the control box to the piping side of the unit.

Table 27. Main valve availability

Digit 20	Cv	2-way, 2-position, N.C.	2-way, 2-position, N.O.	3-way, 2-position, N.C.	3-way, 2-position, N.O.	2-way, modulating	3-way modulating	2-way, analog (2 to 10 Vdc)	3-way, analog (2 to 10 Vdc)
A	2.3	X	X	–	–	X	–	X	–
B	3.3	–	–	–	–	X	–	X	–
C	4.6	X	X	–	–	X	–	X	–
D	6.6	–	–	–	–	X	–	X	–
E	2.7	–	–	X	X	–	X	–	X
F	4.6	–	–	–	–	–	X	–	X
G	7.4	–	–	X	X	–	X	–	X

Table 28. Auxiliary valve availability

Digit 20	Cv	2-way, 2-position, N.C.	2-way, 2-position, N.O.	3-way, 2-position, N.C.	3-way, 2-position, N.O.	2-way, modulating	3-way modulating	2-way, analog (2 to 10 Vdc)	3-way, analog (2 to 10 Vdc)
A	1.4	–	–	–	–	X	–	X	–
B	2.4	X	X	–	–	–	–	–	–
C	3.4	–	–	–	–	X	–	X	–
D	4.8	X	X	–	–	X	–	X	–
E	5.9	–	–	–	–	X	–	X	–
F	2.7	–	–	X	X	–	X	–	X
G	4.6	–	–	–	–	–	X	–	X
H	7.4	–	–	X	X	–	X	–	X



Dimensional Data

Unit Dimensions and Weights

Table 29. Dimensions (inches) and weight (pounds)

Unit Size	075	100	125	150	200
Unit Length (in.)	70.25	82.25	94.25	106.25	106.25
Unit Height (in.)	16.63	16.63	16.63	16.63	17.63
Unit Width (Front Discharge) (in.)	35.63	35.63	35.63	35.63	43.13
Unit Width (Bottom Discharge) (in.)	48.75	48.75	48.75	48.75	57.25
Shipping Weight (lb) ^(a)	340*	375*	435*	500*	600*
Filter Size (inches-actual)	41.50 x 15.25 x 1	53.50 x 15.25 x 1	65.50 x 15.25 x 1	77.50 x 15.25 x 1	77.50 x 15.25 x 1

^(a) Working weight is approximately 10% less than shipping weight. Trane recommends 1/4-inch rods for hanging suspension.

Discharge Dimensions

Ducted Front Discharge

Figure 36. Horizontal unit sizes 075-150 with ducted front discharge

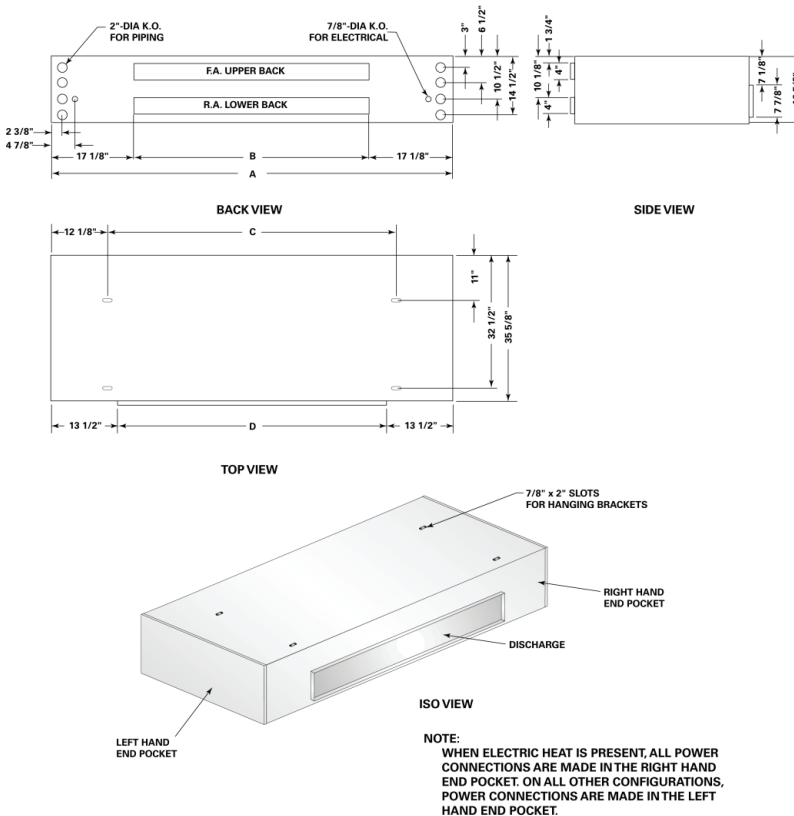

Table 30. Horizontal unit size 075-150 with ducted front discharge dimensions (inches)

Size	A	B	C	D
075	70.25	36.00	46.00	43.25
100	82.25	48.00	58.00	55.25

Dimensional Data

Table 30. Horizontal unit size 075-150 with ducted front discharge dimensions (inches) (continued)

Size	A	B	C	D
125	94.25	60.00	70.00	67.25
150	106.25	72.00	82.00	79.25

Figure 37. Horizontal unit size 200 with ducted front discharge

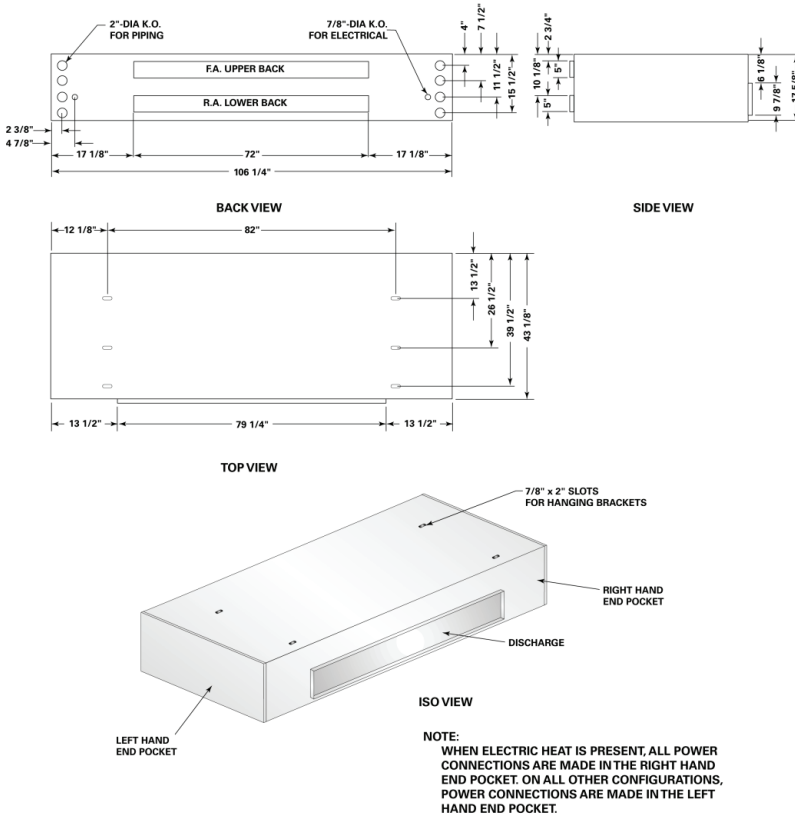

Double Deflection Discharge

Figure 38. Horizontal unit sizes 075-150 with bottom double deflection discharge

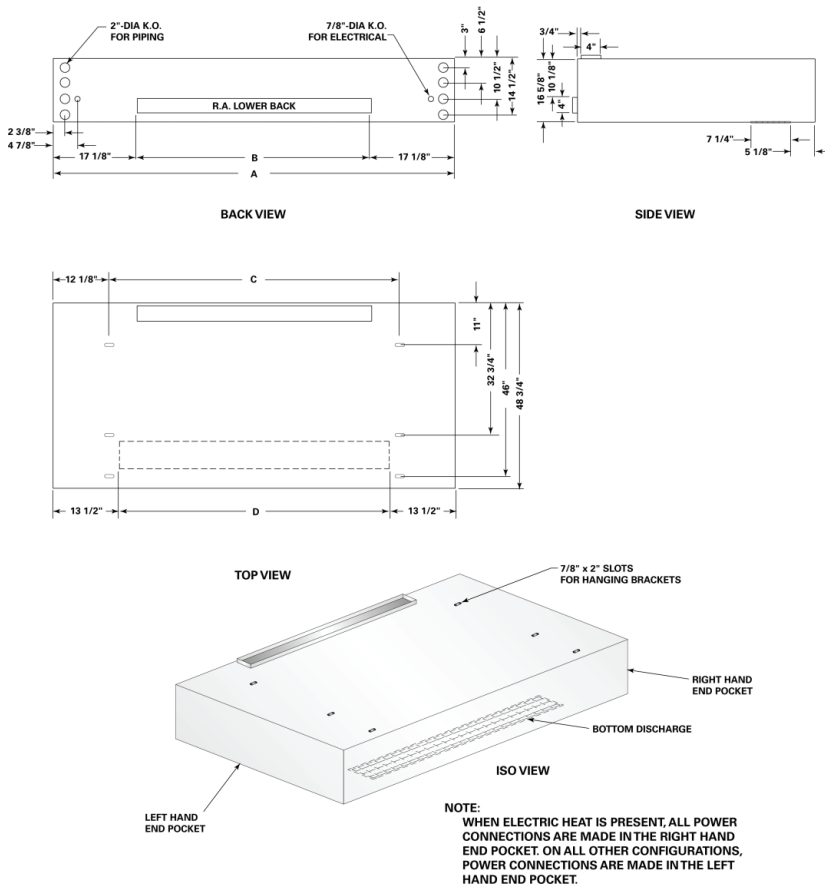

Table 31. Horizontal unit size 075-150 with bottom double deflection discharge dimensions (inches)

Size	A	B	C	D
075	70.25	36.00	46.00	43.25
100	82.25	48.00	58.00	55.25
125	94.25	60.00	70.00	67.25
150	106.25	72.00	82.00	79.25



Dimensional Data

Figure 39. Horizontal unit size 200 with bottom double deflection discharge

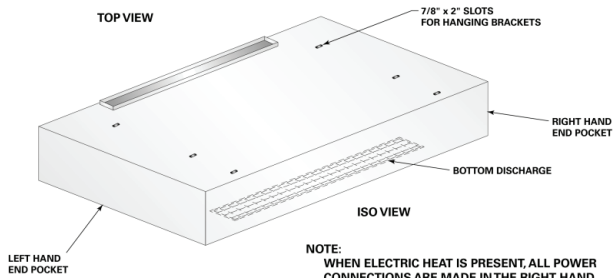
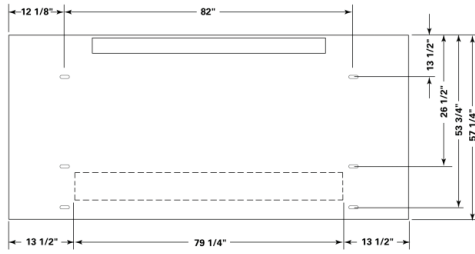
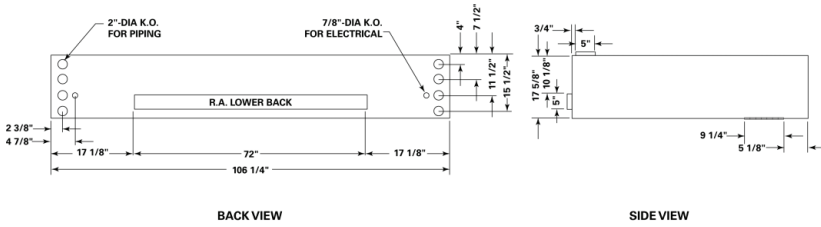

NOTE:
 WHEN ELECTRIC HEAT IS PRESENT, ALL POWER CONNECTIONS ARE MADE IN THE RIGHT HAND END POCKET. ON ALL OTHER CONFIGURATIONS, POWER CONNECTIONS ARE MADE IN THE LEFT HAND END POCKET.

Inlet/Discharge Arrangements

Figure 40. Horizontal unit inlet and discharge arrangements sizes 075-150

INLET ARRANGEMENT: UNIT SIZE 075-150

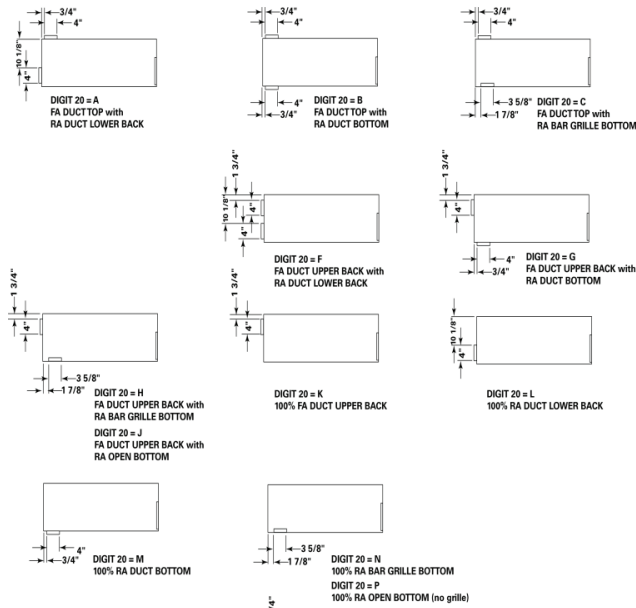

DISCHARGE ARRANGEMENT: UNIT SIZE 075-150

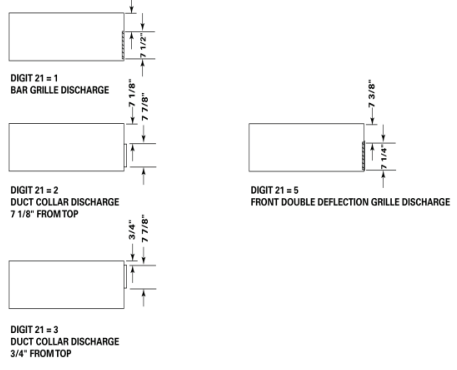
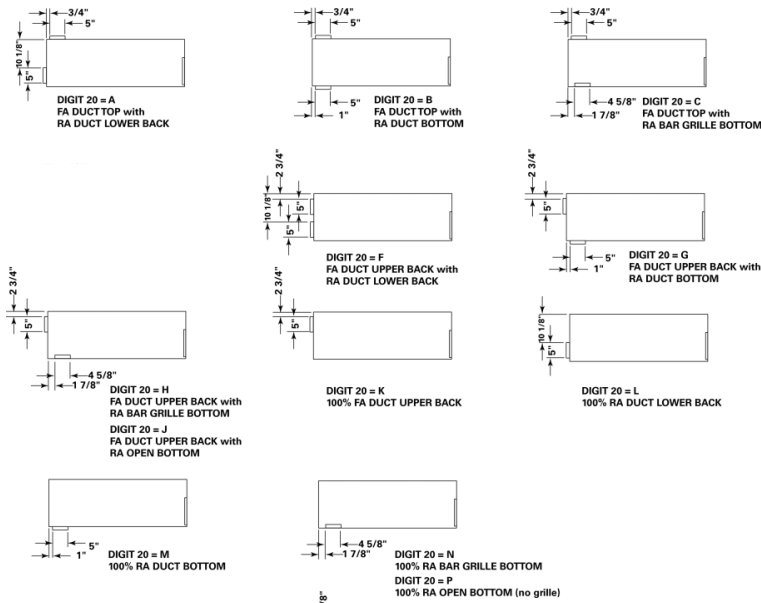
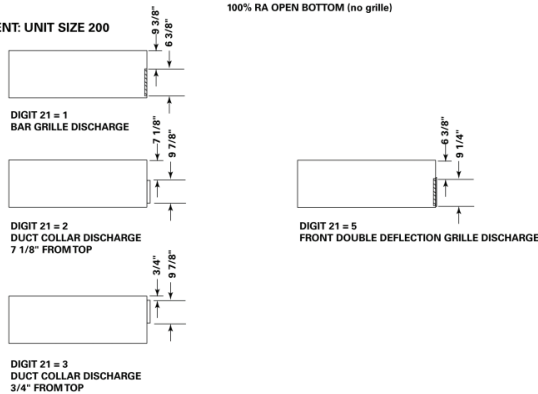

Figure 41. Horizontal unit inlet and discharge arrangements size 200

INLET ARRANGEMENT: UNIT SIZE 200



DISCHARGE ARRANGEMENT: UNIT SIZE 200



Drain Pan Connection

Figure 42. Drain pan connections

RIGHT HAND DRAIN PAN CONNECTION

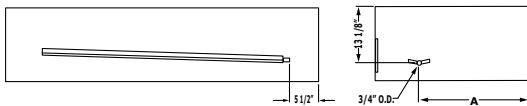

LEFT HAND DRAIN PAN CONNECTION

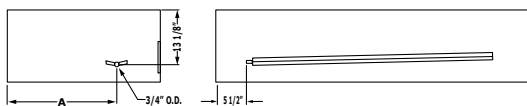

Note: Drain pan connections terminate in the same end pocket as the cooling coil connections. Drain pan connections can be converted to the opposite side at the job site.



Mechanical Specifications

General

Deliver and install a complete unit ventilator certified for ventilation at AHRI-840, or tested by an independent testing and balancing lab witnessed by owner's representative. All non-AHRI manufacturers shall be within 10 percent of catalog airflow and capacities, or removal of these units from the jobsite may be required at the expense of the manufacturer or contractor.

Performance and Safety

All standard units are UL-listed in the United States and Canada and comply with NFPA 90A requirements.

The unit ventilator is certified or rated in accordance to the following listings for performance proof and safety: UL, AHRI-840, AHRI-350, BACnet®.

Equipment Construction

Exterior cabinet is constructed of heavy-gauge metal for strength and durability. All interior sheet metal is galvanized steel to restrain against deterioration.

The bottom plane of the unit shall consist of a two panel design. A hinged panel option is provided as part of the equipment options to help alleviate hazards from falling panels during maintenance or inspection purposes. The control compartment is accessible without removing the entire bottom panel. The unit discharge grilles are welded or screwed in-place to become an integral part of the unit structure. The rounded edge steel bars are placed at a 10° slope to provide proper airflow deflection.

Access for inspection and cleaning of the unit drain pan, coils, and fan section are provided. The unit shall be installed for proper access. Procedures for proper maintenance of the unit are included in the installing, operation manual.

Cabinet insulation is 1/2-inch thick, dual density bonded glass fiber. The exposed side is a high density, erosion proof material suitable for use in air streams up to 4500 feet per minute (FPM). Insulation shall meet the Underwriters' Laboratories Fire Hazard Classification.

Piping and control end pockets are a minimum of 12 inches wide to facilitate coil piping and service access. If standard end pocket is less than 12 inches wide, an extended cabinet are provided.

Final finish is cleaned, phosphatized and painted with an electrostatic powder spray system, with a minimum thickness of 1.5 mil to avoid visible runs and resist abrasion.

Coils

Hydronic Coils

All hydronic coils are plate-fin type, mechanically bonded to tubes. The coils are hydrostatically tested to 350 psi and burst tested to 450 psi. The coils are rated in accordance with AHRI-440 or 220. A threaded drain plug is provided at the header's lowest point, and a manual air vent provided at its highest point.

The standard four-pipe heating coil is in the preheat location. Optional four-pipe heating coils have the heating coil in the reheat position for dehumidification control.

Refrigerant Coils

Direct-expansion (DX) coils contain copper tubes mechanically expanded into evenly spaced aluminum fins. All coils are proof and leak tested before leaving the manufacturer. The proof test is performed at 1.5 times the maximum operating pressure, and leak tested at the maximum operating pressure. In addition, the tubes are completely evacuated of air to check for leaks in the vacuum.

The refrigerant coil distributor assemblies Venturi or orifice style with round copper distributor tubes.

Distributors are sized consistently with capacity of coil. Suction headers are fabricated from round copper pipe.

A thermostatic expansion valve (TXV) are factory selected and installed for a wide-range of control to maintain optimum control of superheat.

Refrigerant access ports are factory supplied on high and low side for ease of refrigerant pressure or temperature testing. All coils are shipped with a dry-nitrogen charge.

For VRF Applications, the DX Coil will be built without the TXV so that an Electronic Expansion Valve (EXV) can be installed in the field.



Mechanical Specifications

Electric Heat Coil

Units equipped for electric heat have a special resistance heating element design inserted in an extended surface fin-tube bundle for maximum element life and safety. Units specifying electric heat include (as standard) both automatic reset and backup single-use, high temperature cut-outs with a continuous sensing element. These devices interrupt electrical power whenever excessive temperatures are sensed anywhere along either side of the coil. A contactor is included to ensure positive disconnect of electrical power whenever the fan motor power is interrupted. All electric heat units have a power wiring console in the right hand end-pocket to facilitate field wiring of the unit.

Steam Coil

Units including a steam coil are of a 5/8-inch, sigma-flow, tube-in-tube, distributing coil design. Steam coil tubing is mechanically expanded into evenly spaced aluminum fins. The supply and return connections are on the same side, and include a 1 inch FPT termination. The coil is pitched by the manufacturer to provide condensate drainage.

Leak Detection Sensors

Unit shall be furnished with a leak detection system from the factory when a circuit refrigerant charge exceeds 3.91 lb of R-454B or 4.04 lb of R-32 refrigerant. The leak detection system shall consist of one or more refrigerant detection sensors. When the system detects a leak, the unit controller shall initiate mitigation actions.

Note: *If factory installed controls are not selected, leak detection sequence of operation must be programmed by controls contractor for all field-installed controls. See UL 60335–2–40 for more information.*

Unit Fans

The unit fan board assembly shall ship from the factory wired to the commission schedule for engineered cfm expectancy. A fan speed switch is on the unit or wall for motor speed adjustment.

The fan board is a single, rigid construction, made from corrosion resistive material. It is a trouble-free slide design to provide cleaning and serviceability ease to maintenance personnel.

The fans contain a double width/double inlet, forward curved centrifugal design to sustain appropriate air throw into the space. The wheels are galvanized metal to resist corrosion. The dynamically balanced fan and motor are of direct drive style.

The fan and coil arrangement are of a blow-thru configuration to supply unvarying coil face velocity avoiding cold spots on the coil.

Motors

All motors are brushless DC (BLDC) electronically commutated motors (ECM) factory-programmed and run-tested in assembled units. The motor controller is mounted in a touch-safe control box with a built-in integrated user interface and LED tachometer. If adjustments are needed, motor parameters can be adjusted through momentary contact switches accessible without factory service personnel on the motor control board. Motors will soft-ramp between speeds to lessen the acoustics due to sudden speed changes. The motor will choose the highest speed if there are simultaneous/conflicting speed requests. All motors have integral thermal overload protection with a maximum ambient operating temperature of 104°F and are permanently lubricated. Motors are capable of starting at 50 percent of rated voltage and operating at 90 percent of rated voltage on all speed settings. Motors can operate up to 10 percent over voltage.

Dampers

Outside Air/Return Air Damper

Each unit ventilator design results in a fixed air, compressible seal to ensure proper modulation and mixing of the return and outdoor air. The damper is capable of varying proportion of mixed air from 100 percent room air to 100 percent outside air.

Face-and-Bypass Damper

Face and bypass damper control is provided on the unit ventilator. This bypass damper design is utilized for economizing and dehumidification of the equipment during seasonal or morning warm-up. The damper is constructed of aluminum grade. The damper is tightly sealed and designed to minimize heat pickup in the bypass position.

A coil isolation valve is a selectable option.

Drain Pan

The unit drain pan consist of a corrosion resistant, environmentally friendly design to facilitate condensate removal quickly. It is insulated on the bottom to prevent sweating. The pan is removable for cleaning. The drain connection is easy for the field to reverse to the opposite end.

Filters

Units equipped with a standard throwaway filter have an average resistance of 76 percent and dust holding capacity of 26 grams per square foot.

Units equipped with 1-in. MERV 8 filters have a rating based on ASHRAE Standard 52.2. The average dust spot efficiency is no less than 35 to 40 percent when tested in accordance with ASHRAE Standard 52.1 atmospheric dust spot method.

Units equipped with 1-in. MERV 13 filters have a rating based on ASHRAE Standard 52.2. The average dust spot efficiency is no less than 90 percent efficiency on 1–3 micron particles and greater than 90 percent efficiency on 3–10 micron particles when tested in accordance with ASHRAE Test Standard 52.2.

Controls

Controls options are customer supplied terminal interface (CSTI) and Symbio™ 400-B. A variety of inputs and outputs are available for the CSTI and Tracer controller options. A disconnect switch (for non-electric heat units), fused transformer, contactors, and terminal strip are provided with the CSTI and Tracer controller options.

Customer Supplied Terminal Interface (CSTI)

The control interface is intended to be used with a field-supplied, low-voltage thermostat or controller. The control box contains a relay board which includes a line voltage to 24-volt transformer, and an optional disconnect switch. All end devices are wired to a low-voltage terminal block and are run-tested, so the only a power connection and thermostat/controller connection is needed to commission the unit. Entering water temperature sensor and controls are provided whenever a changeover coil is selected. When N.O. valves are selected, inverting relays are provided for use with standard thermostats.

Symbio™ 400-B Controller

The Tracer® controller delivers single zone VAV control in a stand-alone application or as part of a Trane Integrated Comfort system with BACnet® communication. The Tracer offers the combined advantages of a factory-mounted, -wired, and -programmed controller for dependable out-of-the box operation. Standard control features include options normally available on more elaborate control systems. All control options are available factory-programmed with additional configuration and programming in the field using a service tool.

The Symbio 400/Symbio 400-B is a multi-purpose, programmable (or application-specific) controller that provides direct-digital zone temperature control. The controller can operate as a stand-alone device or as part of a building automation system (BAS). Communication between the controller and a BAS occurs on an open standard with inter-operable protocols used in Building Automation and Control Networks (BACnet®). Programming is done by means of the Tracer TU service tool.

Zone Sensors

Trane offers a full line of wired and wireless temperature sensors. Wired temperature sensors are the suitable alternative for locations that cannot accommodate wireless sensors or that require a service tool connection. Wireless temperature sensors, which provide easy and flexible installation, are a cost-effective alternative to wired sensors.

Some additional options available with the sensors include:

- Easy-to-use display interface for clear and simple monitoring and control.
- Temperature setpoint control to allow the tenant to choose a temperature setpoint that satisfies their personal preference.
- Fan speed switch to allow the tenant to locally control the fan speed to better satisfy their preference.
- Occupancy override to allow the tenant to request temporary timed override system operation that keeps the building conditions in occupied comfort conditions.
- COMM module that is compatible with all Trane wired temperature sensors. This accessory provides a local RJ22 connection to Trane service tools for easy, low-cost maintenance.

Piping Packages

All piping packages are proof-tested at 300 psig (air) and leak tested at 100 psig (air under water).

Mechanical Specifications

The maximum working pressure of the interconnecting piping is 300 psig. For hydronic applications, maximum working temperature is 200°F except for applications with up to 50% glycol where the limit is 180°F. Control valves are mounted in all piping packages. All piping packages are factory installed and come in a variety of options:

- **Basic:** Union and shut-off ball valve on the supply line. Union, control valve and shut-off ball valve on the return line.
- **Basic with manual circuit setter:** Union, shut-off ball valve on the supply line. Union, control valve and manual circuit setter on the return line.
- **Deluxe with manual circuit setter:** Union, strainer, P/T port, and shut-off ball valve on the supply line. Union, control valve and manual circuit setter on the return line.
- **Deluxe with auto flow:** Union, strainer, P/T port, and shut-off ball valve on the supply line. Union, control valve, auto flow valve, P/T port and shut-off ball valve on the return line.

Control Valves

Control valves are ball valve design with zero leakage. The ball valve incorporates self-cleaning technology to provide superior clog resistance. The actuator is easily removable for service without removing the valve body.

Figure 43. 2-way and 3-way water control valves – 1.4 to 6.6 Cv



Material	Media Temperature	Working Pressure	Differential Pressure	Close off Pressure
Body - Forged	36°F Min	360 psig	40 psig	75 psig
Brass Ball - Chrome Plated Brass	212°F Max	–	–	–
Stem - Brass	–	–	–	–
Seats - PTFE	–	–	–	–
O-rings - EPDM (lubricated)	–	–	–	–

Figure 44. 3-way water control valve – 7.4 Cv



Material	Media Temperature	Working Pressure	Differential Pressure	Close off Pressure
Body - Forged Brass Nickel Plated	0°F min	600 psig	50 psig	200 psig
Ball - Stainless Steel	250°F max	–	–	–
Stem - Stainless Steel	–	–	–	–
Seats - PTFE	–	–	–	–
O-rings - EPDM (lubricated) Characterizing Disk - Tefzel®	–	–	–	–

Figure 45. Steam Control Valve – 1.8, 4.6, 7.3 Cv

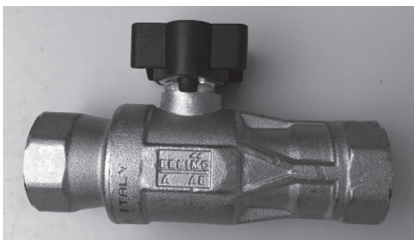

Material	Media Temperature	Working Pressure	Differential Pressure	Close off Pressure
Body - Brass	250°F max	15 psig Max	15 psig	200 psig
Ball - Stainless Steel	–	–	–	–
Stem - Stainless Steel	–	–	–	–
Seats - ETFE	–	–	–	–
Characterizing Disk - ETFE	–	–	–	–

Table 32. Control valve actuators

Actuator Type	Media Temperature	Ambient Temperature	Power Supply	Transformer Sizing	Power Consumption	Stroke Time
2 Position – 1.4 to 6.6 Cv	36°F Min 200°F Max	35°F Min 104°F Max	24 Vac 50/ 60Hz	5 VA	2.5 Watts	Variable
Modulating/Analog – 1.4 to Variable 6.6 Cv				0.6 VA	0.3 Watts	
2 Position – 7.4 Cv	0°F Min 200°F Max	-22°F Min 122°F Max		5 VA	2.5 Watts	75 seconds
Modulating/Analog – 7.4 Cv				1 VA	1.0 Watts	90 seconds
Steam – 1.8, 4.6, 7.3 Cv	250°F Max	2 VA				

End Valves

Each piping package includes a ball valve on the entering water pipe and one of the following end valve on the leaving water pipe:

- Ball valve
- Manual circuit setter

End valve serves as the field connection points on all the Fan Coil piping packages.

Ball Valve

The ball valve is manual shutoff with a maximum working pressure of 600 psig. The valve handle rotates 90° to a fully open position.

Manual Circuit Setter

A manual circuit setter acts as both a flow setting device and a stop valve. This valve allows water flow through the unit to be set quickly and accurately. The manual circuit setter includes ¼ in. Schrader ports in the valve body. These ports are used to measure the pressure drop across the valve. This pressure drop can be compared to factory supplied curves that relate the pressure drop to a specific flow rate. This valve also has a memory stop that helps find the correct setting quickly.

Figure 46. Manual circuit setter



Material	Temperature	Working Pressure
Body - Bronze	250°F max	300 psig max
Seats - Teflon®	–	–
Internal Components - Brass, Teflon®, EPDM	–	–
Schrader Valve Connections - Brass 1/4 in.	–	–
Indicator Plate - Stainless Steel	–	–
Pointer - Die Cast Zinc	–	–

Automatic Flow Control (Auto Flow Valve)

Automatic Flow Control is located on the return line. This device is a non-adjustable in-line flow control valve that maintains the GPM for the unit with a cartridge sized to a specific flow rate.

Mechanical Specifications

Figure 47. Auto flow valve

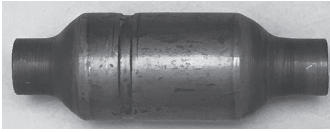

Material	Media Temperature	Working Pressure	Pressure Drop
Valve Body - Copper	32°F min	522 psig	2-80 psig 0.50-5.00 GPM
O-rings - EPDM	225°F max		3-80 psig 5.50-9.00 GPM
Retainer - Stainless Steel	–	–	–
Diaphragm - EPDM	–	–	–
Orifice - Polyphenyl sulfone	–	–	–

Strainer

The strainer is provided with a plug to access the basket. The strainer contains a 20 mesh screen with a working pressure of 300 psig and a maximum water temperature of 210°F.

P/T Port

P/T Port has the ability to measure temperature or pressure of the line.

Figure 48. P/T Port

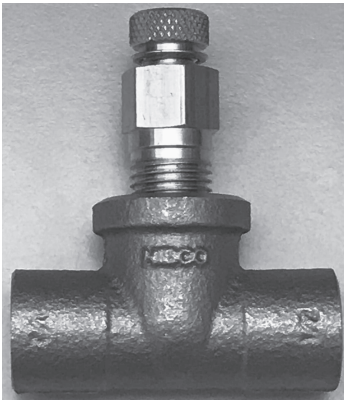

Material	Media Temperature	Working Pressure
Tee Body - Cast Bronze	–	–
P/T Plug Body - Brass	200°F max	500 psig

Bypass Balance Valve

All three-way control valve packages include a balance fitting in the bypass line to allow flow balancing in the bypass position. The balance valve incorporates both a gland screw and stem for manual flow adjustment. The working pressure of this valve is 400 psig.

Union



Material
Nut—Brass
Elbow—Brass
Tail—Copper



The AHRI Certified mark indicates Trane U.S. Inc. participation in the AHRI Certification program. For verification of individual certified products, go to ahridirectory.org.

Trane - by Trane Technologies (NYSE: TT), a global innovator - creates comfortable, energy efficient indoor environments for commercial and residential applications. For more information, please visit trane.com or tranetechnologies.com.

Trane has a policy of continuous product and product data improvements and reserves the right to change design and specifications without notice. We are committed to using environmentally conscious print practices.