



Product Catalog

# Packaged Rooftop Air Conditioners IntelliPak™ 1 with Symbio™ 800

Including eFlex™/eDrive™

Air-Cooled Condensers

20 to 130 Tons





# Introduction

## Designed for Today and Beyond

Innovative technology and an impressive lineup of features make the Trane IntelliPak™ rooftop line the number one choice for today and the future.

- 20 to 130 ton industrial commercial rooftop available in different efficiency tiers.
- R-454B optimized design.
- All units are ASHRAE 90.1 2019 compliant.
- Symbio™ 800 controller now powers the actions of the IntelliPak rooftop for reliable and efficient operation.
- Symbio 800 controller supports multiple communication protocols:
  - Air-Fi®
  - BACnet® MSTP
  - BACnet® IP
  - ModBus® MSTP
  - ModBus® IP
  - LonTalk®
- Symbio 800 user interface provides a high degree of control, superior monitoring capability, and unmatched diagnostic information.
- IntelliPak has the technology and features to bring total comfort to every building space.
  - Key technologies include:**
    - Statitrac™ space pressure control to manage space pressure control.
    - eFlex™ variable speed compressors to optimize efficiency.
    - Traq™ for accurate outdoor air measurement.
    - Air-Fi® communication platform that minimizes installation time, material, and risk.
    - eDrive™ DDP supply fans for ease of maintenance.
  - Highlighted features include:**
    - Electronic expansion valves.
    - Expansion module for custom programmability.
    - Optimized economizer controls.
    - AMCA-rated ultra low leak dampers.
    - Double-wall insulation.
    - Stainless steel drain pan.
    - Modulating relief/return fans.
    - Airflow configuration for more flexibility.
    - Refrigeration monitoring via communicating transducers.
    - Filtration options to meet indoor air quality requirements.

## Copyright

This document and the information in it are the property of Trane, and may not be used or reproduced in whole or in part without written permission. Trane reserves the right to revise this publication at any time, and to make changes to its content without obligation to notify any person of such revision or change.

## Trademarks

All trademarks referenced in this document are the trademarks of their respective owners.

## Revision History

- Updated the General Data - 20 to 50 tons, General Data - 55 to 75 tons, and General Data - 90 to 130 tons tables in the General Data chapter.
- Updated the Compressor electrical service sizing data (20 to 130 tons) table in the Electrical Data chapter.



# Table of Contents

Features and Benefits .....	7
Cabinet .....	7
Refrigeration .....	8
Airflow .....	9
Electrical .....	9
Gas Heat .....	10
Electric Heat .....	10
Options .....	11
Symbio™ 800 Controls .....	14
Features and Benefits .....	14
Options .....	15
Specifications .....	15
Variable Air Volume (VAV) Operation .....	16
Single Zone Variable Air Volume (SZVAV) Operation .....	18
SZVAV and VAV Operation .....	20
Application Consideration .....	27
Clearance Requirements .....	27
Efficiency Offerings .....	27
Supply Fan Flexibility .....	27
Relief/Return Fan Options .....	27
Horizontal Supply and Return .....	29
Acoustic Considerations .....	32
Corrosive Atmospheres .....	33
Ventilation Override Sequences .....	33
Natural Gas Heating Considerations .....	34
High Entering Return Temperature Applications .....	34
A2L Application Considerations .....	34
Modulating Hot Gas Reheat .....	36
IntelliPak™ Replacement Unit (IRU) .....	36

Selection Procedure .....	37
Cooling Capacity Selection .....	37
Heating Capacity Selection .....	39
Air Delivery Procedure .....	40
Modulating Hot Gas Reheat Selection .....	41
Unit Electrical Requirements .....	41
Altitude Corrections .....	41
Model Number Description .....	43
20 to 75 Tons, Air Cooled .....	43
90 to 130 Tons, Air Cooled .....	46
General Data .....	48
Performance Adjustment Factors .....	56
Performance Data .....	58
Gross Cooling Capacities .....	58
Heating Performance .....	88
Supply Fan Performance .....	92
Component Static Pressure Drops .....	119
Fan Drive Selections .....	121
Electrical Data .....	128
Electrical Service Sizing .....	128
Dimensional Data .....	134
Weights .....	138



## Table of Contents

---

Mechanical Specifications .....	139
General .....	139
Casing .....	139
Refrigeration System .....	139
Air-Cooled Condensing .....	140
Air Handling System .....	141
Electrical .....	141
Symbio™ 800 Controller .....	142
Filters .....	143
Relief Air .....	144
Return Air .....	145
Outside Air .....	145
Heating System .....	147
Miscellaneous Options .....	147
Service .....	148
IntelliPak™ Replacement Unit (IRU) .....	148
Accessories .....	148
Certified AHRI Performance .....	149



# Features and Benefits

## Cabinet

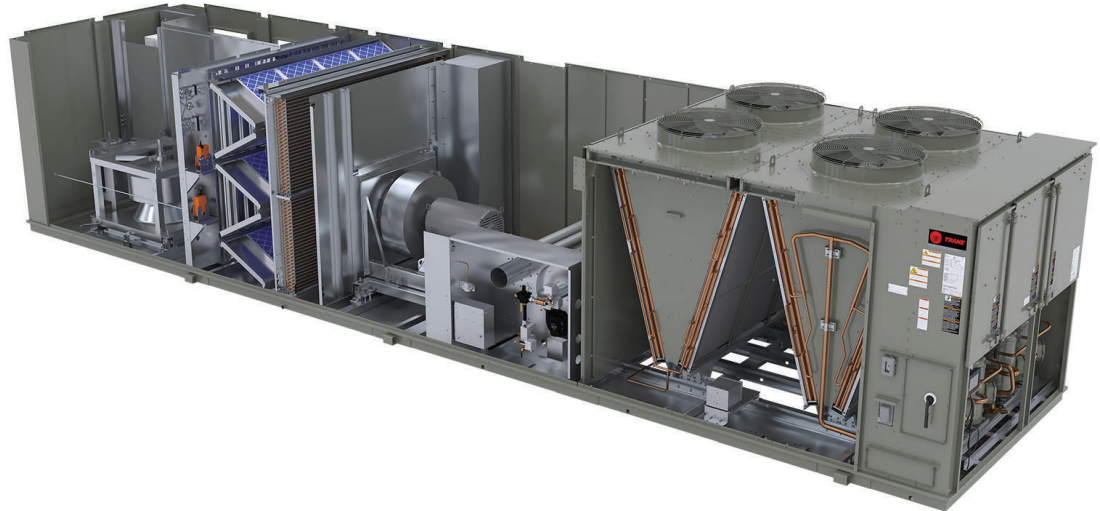

Features		Benefits
Standard	Salt spray testing IAC w ASTM B117 standard	Withstands corrosive environments
	Pitched roof over air handler section	Prevents water leakage in cabinet, pooling water on top of cabinet, as well as paint wear
	Static pressure up to 4 wg	Unit cabinet can operate at static pressure 4 wg on the fan outlet
Optional	Airflow configuration	Downflow and horizontal airflow configurations available for application flexibility
	Hinged access doors	Provide easy and fast access to critical sections of the unit
	Extended casing	Versatility for heating and cooling applications
	Double wall construction	Quality construction enables ease of maintenance
	Stainless steel drain pan	Prevents standing water under the evaporator coil
	IntelliPak Replacement Unit (IRU)	Support for full perimeter curb replacement applications



# Refrigeration

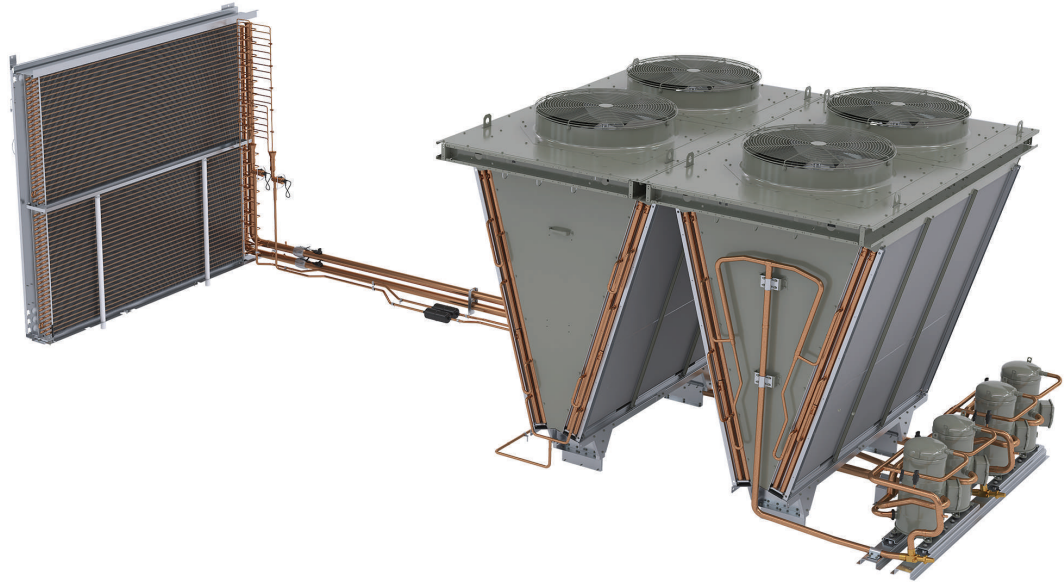

Features		Benefits
Standard	R-454B Refrigerant	HFC Refrigerant
	Refrigerant Leak Detection Sensor	Factory installed. Per Safety Standard UL 60335-2-40 monitors for leaks and activates mitigation if necessary <ul style="list-style-type: none"> <li>• Reduces the risk of improper installation in the field</li> <li>• Bypasses the added cost in the field for installation</li> </ul>
	Microchannel condenser coil	Reduced refrigerant quantity enabling LEED EA Credit 4, decreased weight, and minimized galvanic corrosion
	Electronic expansion valve	<ul style="list-style-type: none"> <li>• More accurate superheat reading and control</li> <li>• Provides consistent super heat setting that improves efficiency and compressor reliability</li> </ul>
	Refrigeration pressures constantly monitored by transducers	<ul style="list-style-type: none"> <li>• Provides faster, more accurate readings that maximize efficiency of the refrigeration system</li> <li>• Monitors compressors in real time to ensure performance within reliable limits</li> <li>• Allows service technician to read system pressures at either the user interface or remotely through optional building automation system (BAS)</li> <li>• Provides loss of charge protection</li> </ul>
	Coil frost protection limit	Temperature and pressure sensors on each refrigeration circuit used to determine if the coil is approaching a freezing condition
	Refrigeration systems meet ASHRAE 90.1	Allows customers to meet both U.S. Department of Energy and local/state regulatory requirements
Optional	High efficiency tiers	Allows customers the flexibility to balance budgets and efficiency requirements
	eFlex™ variable speed compressors	Capacity control delivers improved efficiency as well as more precise leaving air temperature control (+/- 1°F)
	Variable speed condenser fans	Minimizes fan cycling and maximizes part load efficiency by closer control to minimum head pressure
	Low ambient control	Provides refrigeration cooling in lower ambient temperatures to 0°F, improving the unit's operating range
	Suction Service Valve	Reduces service time if repairs are needed
	Replaceable core filter driers	Allows for quicker replacement



## Airflow

Features		Benefits
Standard	Variable speed supply fan with forward curved, airfoil-shaped blades	<ul style="list-style-type: none"> <li>Variable speed technology enables precision adjustments to output and/or capacity according to the building space requirements</li> <li>Flexibility to achieve specific cfm requirements for the application</li> </ul>
Optional	eDrive™ variable speed direct drive supply fans <sup>(a)</sup>	<ul style="list-style-type: none"> <li>Variable speed technology enables precision adjustments to output and/or capacity according to the building space requirements</li> <li>No belts or sheaves reduces maintenance requirements</li> <li>More efficient, higher static capability, and improved acoustics relative to forward curved fans</li> <li>Precision fan speed adjustments ensure energy-efficient, indoor comfort without the need for belt/sheave replacements</li> </ul>
	Trane Air Quality (TraQ™) outside air measurement system	Traq controls the amount of outdoor air intake to accurately meet minimum fresh air requirements and energy-efficiency goals
	Statitrac™ direct space building pressurization control	Highly accurate and efficient method of maintaining building pressure control
	Ventilation override mode	Flexibility to temporarily override airflow management during non-standard situations
	Economizer operations	Enables use of outside air as an initial stage of cooling, reducing compressor run-time, resulting in lower energy consumption and longer unit lifespan
	Pre-evaporator and final filter rating up to MERV 14	<ul style="list-style-type: none"> <li>Variety of options available to meet indoor air/filtration requirements</li> <li>Filter status available at the user interface and/or building automation system</li> </ul>
	Relief Fans	The Trane 100% modulating relief fan is an excellent choice for controlling building pressure
	Return Fans	Trane's 100% modulating return fan is an excellent choice for systems with high return static pressure losses

<sup>(a)</sup> Available on 20–75 ton units only.

## Electrical

**Figure 1. Control panel 20 to 75 tons**

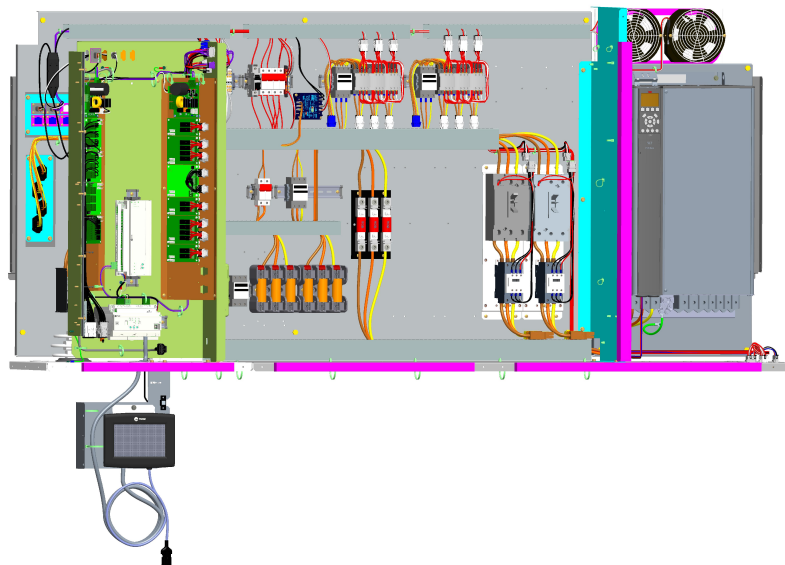



## Features and Benefits

Features		Benefits
Standard	Wired and tested at the factory	Reliable unit startup
	Separated high and low voltage components and wiring	Improved safety during servicing; reduced potential for signal interference to controls
	Variable frequency drives communicate via Modbus	Real time information as the drives are connected directly to the building automation system
	Separate access for user interface and USB connection	Ability to access controller functions without opening the control panel
	Dual power connection for 20-75 ton 200, 230V units with electric heat	Limits size and cost of power supply to unit
	Modular electrical component architecture	Standardized design simplifies service needs
Optional	Optional high SCCR	Meets needs of building systems with high available fault currents

## Gas Heat

Features		Benefits
Standard	Drum and tube heat exchangers with forced draft burners tested under UL 795	Meets product safety regulations
	81% steady state efficiency	All gas heaters meet the 2023 Department of Energy efficiency code
	Flue to relief above the unit	Removes hot air away from the unit and prevents recirculation with the combustion intake
Optional	<ul style="list-style-type: none"> <li>Staged offering for each MBH</li> <li>Modulating and Ultra Modulating offerings for 500, 850, and 1000 MBH</li> <li>Low and high heat offering</li> </ul>	<ul style="list-style-type: none"> <li>Air rise capability up to 60°F to meet discharge air temperature requirement</li> <li>Assortment of option combinations provides the best solution for a variety of applications, along with the ability to achieve turndown up to 20:1</li> </ul>

## Electric Heat

Features		Benefits
Standard	Full-faced element coil	Creates a more consistent heat profile
	<ul style="list-style-type: none"> <li>High grade element wire</li> <li>Low watt density heater coils</li> </ul>	Allows for increased reliability
	30 to 190 kW range	Provides best solution for the application
	Air rise capability up to 50°F	Range of capacity meets discharge air temperature requirements



# Options

**Table 1. Comprehensive listing of available options and accessories**

Option or Accessory <sup>(a)</sup>	Option	Standard Field-Installed Accessory
<b>Coils</b>		
Corrosion Protected evaporator coils	X	
Corrosion protected condenser coil	X	
<b>Controls</b>		
LonTalk® Communication Interface	X	X
BACnet® Communication Interface (MSTP or IP)	X	
Trane® Air-Fi® Wireless Communications Interface	X	
ModBus Communication (MSTP or IP)	X	
Expansion Module (XM-70)	X	X
Wi-Fi Module	X	X
Power Meter	X	
Fault detection and diagnostics with ultra low leak economizer option	X	
Isolation damper control module <sup>(b)</sup>	X	
Single Zone VAV	X	
Rapid Restart	X	
Outside Air Measurement (Traq™)	X	
Demand Control Ventilation (DCV)	X	
Space Pressure Management (Statitrac™)	X	
Ventilation override module (five ventilation override sequences)	X	
100 percent modulating relief fan with or without Statitrac™ space pressure control	X	
100 percent modulating return fan with or without Statitrac™ space pressure control	X	
<b>Outside Air</b>		
0-25 percent manual dampers	X	
Standard dampers (0-100 percent modulating)	X	
Low leak dampers (0-100 percent modulating)	X	
Ultra low leak dampers (0-100 percent modulating)	X	
<b>Relief or Return</b>		
Barometric relief dampers (20-75 tons)	X	
<b>Drain Pans</b>		
Positively sloping evaporator coil drain pan	X	
Stainless steel positively sloping evaporator coil drain pan	X	
<b>Economizer</b>		



## Options

**Table 1. Comprehensive listing of available options and accessories (continued)**

Option or Accessory <sup>(a)</sup>	Option	Standard Field-Installed Accessory
0-100 percent modulating outside air economizer controlled by: <ul style="list-style-type: none"> <li>• Comparative Enthalpy</li> <li>• Reference Enthalpy</li> <li>• Dry Bulb</li> <li>• Differential Dry Bulb</li> </ul>	X	
<b>Electrical</b>		
Convenience outlet (factory-powered 15A GFI)	X	
Dual power source	X	
Unit mounted disconnect switch with through the door external handle	X	
Phase monitors (200/230/460/575V) (S_HP 20 to 75 tons)	X	
Phase monitors (460/575; S_HR 90 to 130 tons)	X	
High fault SCCR (short circuit current rating)	X	
<b>Fans</b>		
100 percent modulating relief fan with or without Statitrac™ space pressure control	X	
100 percent modulating return fan with or without Statitrac™ space pressure control	X	
eDrive™ direct drive plenum supply fans (20 to 75 tons)	X	
Supply Fan Piezometer	X	
Horizontal Return fans	X (20–75 Ton)	
<b>Filters, Filter Racks and Related Tools</b>		
90-95 percent bag filters	X	
90-95 percent cartridge filters	X	
90-95 percent bag or cartridge final filters and rack	X	
Filter rack only (no filters)	X	
Final filters, cartridge (SX only)	X	
Filter rack - 4" deep panel rack placed in standard rack location	X	
High efficiency throwaway filters	X	
Filter Monitoring for Pre-Evap and Final Filters	X	
<b>Heat</b>		
Heating options: natural gas, electric, hot water or steam	X	
Modulating Gas Heat	X	
Propane (LP) conversion / Modulating LP heat		X
Ultra Modulating Gas Heat	X	
Two Stage Gas Heat	X	
<b>Insulation</b>		
Double wall	X	
<b>Motors</b>		
Motors with internal shaft grounding ring for VFD applications	X	
<b>Other</b>		

**Table 1. Comprehensive listing of available options and accessories (continued)**

Option or Accessory <sup>(a)</sup>	Option	Standard Field-Installed Accessory
eFlex™ Variable Speed Compressors (20 to 75 ton)	X	
Extended grease lines	X	
Modulating hot gas reheat (20 to 75 tons)	X	
Hinged access doors	X	
Horizontal supply and return openings (SX, SL, SS, SL, SF <sup>(c)</sup> models)	X	
Hot gas bypass to the evaporator inlet	X	
IntelliPak™ Replacement Unit (IRU)	X	
Outside air CFM compensation on VAV units with VFD and economizer	X	
Roof curbs		X
Suction service valves	X	
Vertical discharge, S_HP 20 to 75 tons (SX,SL,SS,SL models only)	X	

<sup>(a)</sup> Options are provided for informational purposes only. For specifics, contact your local Trane® sales office.

<sup>(b)</sup> Module is factory-installed only, damper is field-supplied.

<sup>(c)</sup> Limited tonnage availability.

**Note:** For design specials, contact product support.



# Symbio™ 800 Controls

The Symbio™ 800 controller is a factory-installed, application specific and programmable controller designed to control chillers and large packaged HVAC equipment. A 7-inch user interface features a touch-sensitive color screen that provides facility managers at-a-glance operating status, performance monitoring, scheduling changes, and operating adjustments. Other advanced features include automated controller back-up, and optional features such as secure remote connectivity, wireless building communications, mobile device connectivity, and custom programming with expandable I/O.

Symbio 800 Advantages	
Connected	Convenient, on-the-go access to advanced monitoring, troubleshooting, and energy management
Flexible	Minimized installation hardware and labor costs – able to use existing devices for maximum convenience, lower controls upgrades and relocation
Reliable	Maximum equipment uptime and life, minimized maintenance and troubleshooting cost

## Features and Benefits

Symbio™ 800 Feature	Benefits
Multiple, open standard protocol support <ul style="list-style-type: none"> <li>• Air-Fi® Wireless (BACnet®/AirFi, optional)</li> <li>• BACnet MS/TP</li> <li>• BACnet/IP</li> <li>• LonTalk® (Optional)</li> <li>• Modbus RTU</li> <li>• Modbus TCP</li> </ul>	Simplified, lower cost, and more flexible integration with all common open standard protocols using Trane or competitive BAS systems and controllers
Remote connection to building or equipment	Trane Connect™ provides an easy, secure option to connect remotely to a Tracer SC+ or directly to your Trane equipment
Common integration strategies and equipment specific points lists	Simplified, lower cost, and uncompromised integration
Application specific and configurable	Reduced project costs with superior reliability, comfort, performance - applications specific and configurable system ensures machine continues to run within operating envelope. Ability to upgrade firmware with a simple file transfer.
Smart Analytics	Smart analytics provide superior reliability through the life of the equipment with minimum downtime
Data logging	Standard, local or remote Intuitive review and analysis of equipment, zone, and building performance
Local scheduling	Capable of operating in stand-alone operation without a building automation system as a temporary back-up schedule for ongoing comfort and energy savings
Rugged, 7-inch color touch screen user interface	Easy, touch navigation for viewing data and making operational changes
Display preferences	Choose how to view dates, times, units (SI, IP), screen brightness, data format, and backlight timeout. 3 built-in languages are supported and selectable for all TD7 screens.
Intuitive navigation	Helps operators access data and alarms for quick and accurate response and resolution
At-a-glance status	Easily readable color display showing key operating parameters of major equipment components
Reports	Quickly summarizes data for clear understanding and interpretation to enable local monitoring of expected performance and operating efficiency
Graphs	Easily visualize trend data for local troubleshooting and fine-tuning
Multiple language support	Suitable for operation in multiple geographies
Adaptive Control™ Algorithms	Pre-empts potential equipment disruptions during rapidly changing conditions – providing consistent equipment performance and building comfort

Symbio™ 800 Feature	Benefits
SD card backup/restore	Faster, lower cost repairs with reduced downtime
Modbus device support	Capable of integrating optional Modbus devices for local or remote diagnostics — provides faster, lower cost troubleshooting and increased equipment performance

## Options

Symbio™ 800 Feature	Benefits
Remote connection to building or equipment	Trane Connect™ provides an easy, secure option to connect remotely to a Tracer SC+ or directly to your Trane equipment, requires an internet connection
Programmable	Equipment application flexibility and cost-reduced control of nearby equipment
Expandable I/O	Field or factory installed I/O for programmable feature - Reduced installation costs and increased installation flexibility
User security with audit trail support	Flexible and secure access for multiple users allows monitoring, overriding/releasing points, release of all overrides, custom report editing, and tracking changes by user
Wi-Fi Adapter	Enables the operation of wireless service tools for increased technician productivity and flexibility
LonTalk®	Supports LonTalk for Tracer building automation and other building control systems
Air-Fi® Wireless (BACnet®/Air-Fi, optional)	The Air-Fi® Wireless enables wireless communications between system controls, unit controls, and wireless sensors for Trane control products that use the BACnet® protocol.

## Specifications

Controller Specifications	
Input power	24 Vdc +/- 10%, 400mA max.
Storage temperature	-67°F to 185°F (-55°C to 85°C), Humidity: Between 5% to 100% (Condensing).
Operating temperature	-40°F to 158°F (-40°C to 70°C).
Environmental rating (enclosure)	IP3x.
Time clock	On-board real time clock with 10 year battery backup.
Mounting weight	Mounting surface must support 1.3 lb. (0.6 kg).
Overall dimensions	5.65 in. (143.5 mm) wide x 4.00 in. (101.6 mm) high x 2.38 in. (60.6 mm) deep.
Agency Compliance	
<ul style="list-style-type: none"> <li>UL PAZX, Energy Management Equipment, UL 60730-1, 5th Ed.</li> <li>UL94-5V Flammability.</li> <li>CE.</li> <li>FCC CFR Title 47, Part 15.109: Class B Limit, (30 MHz—10 GHz).</li> <li>BTL Listed—Advanced Application Profile (B-AAC).</li> </ul>	
User Interface Specifications	
Input power	24 Vdc +/- 10%, 400 mA max
Storage temperature	-67°F to 203°F (-55°C to 95°C), Humidity: Between 5% to 100% (Condensing).
Operating temperature	-40°F to 158°F (-40°C to 70°C), Humidity: Between 5% to 100% (Condensing).
Environmental rating (enclosure)	IP56 (dust and strong water jet protected) with optional sealed Ethernet cable (PN: X19070632020).
Mounting weight	Mounting surface must support 1.6 lb. (0.74 kg).
Overall dimensions	8.3 in. (211.6 mm) wide x 6.3 in. (158.8 mm) high x 2.1 in. (53.2 mm) deep [bezel depth 0.4 in. (11.3 mm)].



## Variable Air Volume (VAV) Operation

### Discharge Air Pressure Control

#### Variable Frequency Drive (VFD) Control

Variable frequency drives are used for supply fan speed control. A pressure transducer measures duct static pressure, and the VFD is modulated to maintain the supply air static pressure within an adjustable user-defined range. The range is determined by the discharge air pressure setpoint and discharge air pressure deadband, which are set through the user interface. or BAS/Network.

The variable frequency drives provide supply fan motor speed modulation. The drive will accelerate or decelerate as required to maintain the discharge static pressure setpoint.

#### Discharge Air Static Pressure Limit

The opening of VAV terminals, and the amount of supply air provided by the variable frequency drive are coordinated during start-up and transition to/from Occupied/Unoccupied modes to prevent over pressurization of the supply air ductwork. However, if for any reason the discharge air pressure exceeds the user-defined discharge air static pressure limit that was set at the user interface, the supply fan and VFD are shutdown. The unit is then allowed to restart three times. If the over pressurization condition occurs on the third restart, the unit is shutdown and a manual reset diagnostic is set and displayed at the user interface and BAS/Network.

### Space Pressure Control - Statitrac

A pressure transducer is used to measure and report direct space (building) static pressure. The user-defined control parameters used in this control scheme are space static pressure setpoint, space pressure deadband and relief enable point. As the economizer opens, the building pressure rises and once above the relief enable point, enables the relief fan and dampers or relief VFD. The relief dampers or VFD then modulate to maintain space pressure within the deadband.

### Discharge Air Temperature Controls

#### Cooling/Economizer

During Occupied cooling mode of operation, the economizer (if available) and mechanical cooling are used to control the discharge air temperature. The discharge air temperature setpoint and deadband are user-defined at the user interface. The discharge air temperature setpoint may be user-defined from the BAS/Network. If the conditions of the outside air are appropriate to use "free cooling," the economizer will be used first in an attempt to satisfy the discharge air setpoint; then, if required, the mechanical cooling will be staged on to maintain discharge air temperature setpoint. Minimum On/Off timing of the mechanical cooling prevents rapid cycling.

On units with economizer, a call for cooling will modulate the outside air dampers open. The rate of economizer modulation is based on deviation of the discharge air temperature from setpoint, i.e., the further away from setpoint, the faster the outside air damper will open. First stage of cooling will be allowed to start after the economizer reaches full open.

The economizer is only allowed to function freely if one of the following conditions is met:

- For dry bulb economizer control the ambient temperature must be below the dry bulb temperature control setting.
- For reference enthalpy economizer control, outdoor air enthalpy must be below the enthalpy control setting. At outdoor air conditions above the enthalpy control setting, mechanical cooling only is used and the outside air dampers remain at minimum position.
- For comparative enthalpy economizer control, outdoor air enthalpy must be below the enthalpy of the return air.
- For differential dry bulb economizer control, the ambient dry bulb temperature must be below the dry bulb temperature of the return air.

If the unit does not include an economizer, mechanical cooling only is used to satisfy cooling requirements. The outdoor air dampers may be set for a maximum of 25% outdoor air, through the unit mounted user interface or a signal from the BAS/network, if the rooftop is equipped with 0 to 25% motorized outside air dampers.



## Heating

### Gas Heating: Staged Heat

Up to two stages of gas heat will be sequenced based on zone demand. Status messages and diagnostics are communicated to the user interface. To prevent cycling, a three-minute delay shall be provided between first- and second- stage, gas valve operation on two-stage heaters.

### Modulating Gas

Modulating gas heat will consist of one modulating valve for precise heating control. The output will be modulated to control the discharge air temperature to the heating setpoint. Status messages and diagnostics are communicated to the user interface.

### Electric Heating

The individual stages of electric heat will be sequenced on the zone demand. The number of available stages will depend on the unit size and heat capacity selected.

## Discharge Air Setpoint Temperature Reset

**Figure 2. Discharge air temperature reset**

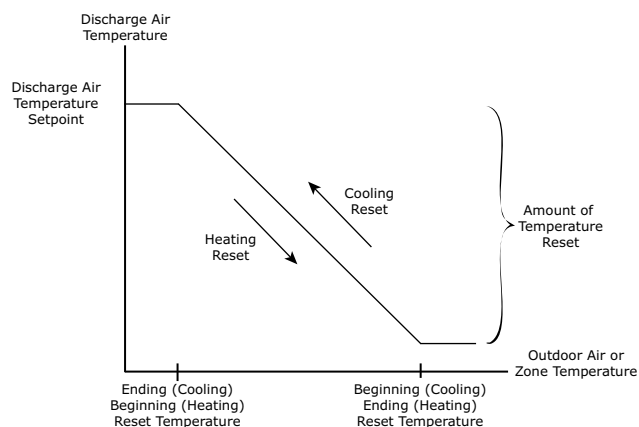

Discharge air setpoint reset can be used to adjust the discharge air temperature setpoint on the basis of a zone temperature or on outdoor air temperature. Discharge air setpoint reset adjustment is available from the user interface for supply air heating and supply air cooling control.

### Outdoor Air Cooling Reset

Outdoor air cooling reset is sometimes used in applications where the outdoor temperature has a large effect on building load. When the outside air temperature is low and the building cooling load is low, the discharge air setpoint can be raised, thereby preventing sub-cooling of critical zones. This reset can lower usage of mechanical cooling, thus savings in compressor kW, but an increase in supply fan kW may occur.

### Outdoor Air Heating Reset

Outdoor air heating reset is the inverse of cooling, with the same principles applied. For both outdoor air cooling reset and heating reset, there are three user-defined parameters that are adjustable through the user interface:

- Beginning reset temperature
- Ending reset temperature
- Amount of temperature reset

### Zone Reset

Zone reset is applied to the zone(s) in a building that tend to be overly cool or overly hot. The discharge air temperature setpoint is adjusted based on the temperature of the critical zone(s). This can have the effect of improving comfort and/or lowering energy usage. The user-defined parameters are the same as for outdoor air reset.



## Supply Air Tempering

A feature that is used with modulating gas, hot water and steam heat option(s). Supply air tempering is enabled when the discharge air temperature falls below the discharge air temperature deadband low end. The heat valve is then modulated open to maintain the set minimum discharge air temperature.

## Zone Temperature Control

### Unoccupied Zone Heating and Cooling

During Unoccupied mode, the unit is operated as a constant volume unit. Supply fan VFDs operate at 100% and VAV boxes are driven full open. The unit controls zone temperature to the Unoccupied zone cooling and heating (heating units only) setpoints.

### Morning Warmup Options

This feature may be enabled on all types of factory installed heat units as well as cooling only units configured as “External Heat” (for example, VAV boxes with reheat). At the conclusion of Unoccupied mode, while the economizer (if supplied) is kept closed, the selected zone is heated to the user-defined Morning Warmup setpoint (see description below). The unit is then released to Occupied mode.

#### Cycling Capacity Morning Warmup (MWU)

Cycling capacity Morning Warmup provides a more gradual heating of the zone. Normal zone temperature control with varying capacity is used to raise the zone temperature to the MWU zone temperature setpoint. This method of warmup is used to overcome the “building sink” effect. Cycling capacity MWU will operate until the MWU setpoint is reached or for 60 minutes, then the unit switches to Occupied mode. A control algorithm is used to increase or decrease the amount of heat in order to achieve the MWU zone temperature setpoint.

**Note:** *When using the Morning Warmup option in a VAV heating/cooling rooftop, airflow must be maintained through the rooftop unit. This can be accomplished by electrically tying the VAV boxes to the VAV box output relay contacts on the Symbio™ 800 Controls or by using changeover thermostats. Either of these methods will assure adequate airflow through the unit and satisfactory heating of the building.*

#### Daytime Warmup

This feature is available on all types of heating units. During Occupied mode, if the zone temperature falls to a preset, user-defined zone low limit temperature setpoint, the unit is put into Unoccupied mode and Daytime Warmup is initiated. The system changes over to constant volume heating (full unit airflow), the VAV boxes are fully opened and full heating capacity is provided until the Daytime Warmup setpoint is reached. The unit is then returned to normal Occupied mode.

## Single Zone Variable Air Volume (SZVAV) Operation

The IntelliPak® controls platform will support Single Zone VAV as an optional unit control type in order to meet ASHRAE 90.1. The basic control will be a hybrid variable air volume/constant volume configured unit that provides discharge temperature control to a varying discharge air temperature target setpoint based on the space temperature and/or humidity conditions. Concurrently, the unit will control and optimize the supply fan speed to maintain the zone temperature to a zone temperature setpoint.

## VFD Control

The VFD will modulate the supply fan motor speed, accelerating or decelerating as required to maintain the zone temperature to the zone temperature setpoint. Bypass control is offered to provide full nominal airflow in the event of drive failure.

## Supply Fan Output Control

Units configured for Single Zone VAV control will utilize the same supply fan output control scheme as on traditional VAV units except the VFD signal will be based on zone heating and cooling demand instead of the supply air pressure.

## Space Pressure Control – Statitrac™

For units configured with Space Pressure Control, the new schemes implemented for economizer minimum position handling require changes to the existing Space Pressure Control scheme in order to prevent over/under pressurization. The overall scheme will remain very similar to VAV units with Space Pressure Control with the exception of the dynamic Relief Enable Setpoint.

For SZVAV, a Relief Enable Setpoint must be selected during the 100% Fan Speed Command. Once selected, the difference between the Relief Enable Setpoint and Design OA Damper Minimum Position at 100% Fan Speed Command will be calculated. The difference calculated will be used as an offset and added to the Active Building Design OA Minimum Position Target in order to calculate the dynamic Relief Enable Target, which will be used throughout the Supply Fan Speed/OA Damper Position range.

The Relief Enable Target could be above or below the Active Building Design OA Minimum Position Target Setpoint, based on the Active Relief Enable Setpoint being set above or below the Building Design Minimum Position at 100% Fan Speed Command. Note that an Relief Enable Setpoint of 0% will result in the same effect on Relief Fan control as on VAV applications with and without Statitrac.

## Occupied Cooling Operation

For normal cooling operation, cooling capacity will be staged or modulated in order to meet the calculated discharge air target setpoint. If the current active cooling capacity is controlling the discharge air within the deadband, no additional cooling capacity change will be requested. As the Discharge Air Temperature rises above the deadband, the algorithm will request additional capacity as required (additional compressors or economizer). As the Discharge Air Temperature falls below the deadband, the algorithm will request a reduction in active capacity.

## Default Economizer Operation

By default, the unit will be set up to optimize the minimum supply fan speed capability during Economizer Only operation. If the economizer is able to meet the demand alone, due to desirable ambient conditions, the supply fan speed will be allowed to increase above the minimum prior to utilizing mechanical cooling if discharge air setpoint falls below the discharge air Lower Limit (Cooling) setpoint.

## Occupied Heating Operation

Occupied heating operation will utilize two separate control methodologies based on heating configurations. For all “Staged” Heating types, the unit will utilize full airflow during all active heating periods exactly like traditional Constant Volume units. For “Modulating” Heating types the unit will have the ability to utilize SZVAV Heating, much like Active Cooling, in order to maintain the Zone Temperature to the Zone Heating setpoint. Also, on units configured with a Modulating Heat type, the customer will have the ability to select between SZVAV Heating control, or to utilize traditional Constant Volume, full airflow heating based on the associated unit setup.

## Unoccupied Mode

In Unoccupied periods the unit will utilize setback setpoints, 0% Minimum OA Damper position, and Auto Fan Mode operation as on normal Constant Volume units. The Supply Fan speed will be forced to 100% to operate in a constant volume mode for all active heating and cooling requests.

## Cooling Sequence

If the controller determines that there is a need for compressor stages in order to meet the calculated discharge air target setpoint, once supply fan proving has been made, the unit will begin to stage compressors accordingly.

**Note:** *The compressor staging order will be based on unit configuration and compressor balanced starts status.*

Once the discharge air target setpoint calculation has reached the user defined Minimum Setpoint and compressors are being utilized to meet the demand, if the cooling demand increases, the discharge air target setpoint value will continue to lower past the minimum setpoint and begin to ramp the supply fan speed upward toward 100%.

Once the discharge air target setpoint calculation has reached the Minimum Setpoint and compressors are being utilized to meet the demand, as the discharge air target setpoint value continues to calculate lower the algorithm will begin to ramp the supply fan speed up toward 100%. Note that the supply fan



speed will remain at the compressor stage's associated minimum value (as described below) until the discharge air target setpoint value is calculated below the discharge air temperature Minimum Setpoint (limited discharge air target setpoint).

As the cooling load in the zone decreases the zone cooling algorithm will reduce the speed of the fan down to minimum per compressor stage and control the compressors accordingly. As the compressors begin to de-energize, the supply fan speed will fall back to the Cooling Stage's associated minimum fan speed, but not below. As the load in the zone continues to drop, cooling capacity will be reduced in order to maintain the discharge air within the  $\pm\frac{1}{2}$  discharge air target deadband.

## Heating

### Gas Heating: Staged Heat

Up to two stages of gas heat will be sequenced based on zone demand. Status messages and diagnostics are communicated to the user interface.

### Modulating Gas

Modulating gas heat will consist of one modulating valve for precise heating control. The output will be modulated as the demand in the zone changes. Status messages and diagnostics are communicated to the user interface.

### Electric Heating

The individual stages of electric heat will be sequenced on the zone demand. The number of available stages will depend on the unit size and heat capacity selected.

## SZVAV and VAV Operation

### Outside Air Control

#### Outside Air Measurement

Trane air quality (TraQ™) outside air measurement system utilizes velocity pressure sensing rings. Based on unit design CFM, the Symbio™ 800 monitors and controls the quantity of outside air entering the unit. The outside airflow can be calibrated to compensate for altitude.

An optional CO<sub>2</sub> sensor may be connected to control outside air based on CO<sub>2</sub> Demand Control Ventilation (DCV).

#### Outside Airflow Compensation

As the supply fan modulates, this function proportionally adjusts the economizer minimum position to compensate for the change in total airflow, in order to maintain a constant percent of outside air. The modified economizer minimum position is computed as a linear function – based on VFD position – given the two endpoints:

- Minimum Position with VFD @ 0%
- Minimum Position with VFD @ 100%

Both are user adjustable at the user interface.

### Unit Feedback – Supply and Relief Fan Speed Setpoints

BACnet® network points are available to allow for communication of the Supply and Relief Fan Speed Setpoints to the BAS. These points are only available for multi-zone VAV units. These setpoints will be overridden by equipment protection functionality, when applicable.

### Emergency Override

When a LonTalk® communication protocol or BACnet® control network is installed, the user can initiate from the Tracer® Ensemble™ building automation system (BAS), Tracer® SC+ or third party BAS one of five predefined, not available to configure, Emergency Override sequences. All compressors condenser fans are de-energized for any Emergency Override sequence. Each Emergency Override sequence commands the unit operation as follows:

<b>PRESSURIZE_EMERG:</b> <ul style="list-style-type: none"> <li>• Supply Fan VFD - Max</li> <li>• Relief Fan - Off; Relief Dampers - Closed (if so equipped)</li> <li>• OA Dampers - Open; Return Damper - Closed</li> <li>• Heat - All heat stages off; Mod Heat output - Off</li> <li>• Occupied/Unoccupied/VAV box output - Energized</li> <li>• VOM Relay - Energized (if so equipped)</li> </ul>	<b>EMERG_DEPRESSURIZE:</b> <ul style="list-style-type: none"> <li>• Supply Fan VFD - Min</li> <li>• Relief Fan - On; Relief Dampers - Open/Max</li> <li>• OA Dampers - Closed; Return Damper - Open</li> <li>• Heat - All heat stages off; Mod Heat output Off</li> <li>• Occupied/Unoccupied/VAV box output - Energized</li> <li>• VOM Relay - Energized</li> </ul>
<b>EMERG_PURGE:</b> <ul style="list-style-type: none"> <li>• Supply Fan VFD - Max</li> <li>• Relief Fan - On; Relief Dampers - Open</li> <li>• OA Dampers - Open; Return Damper - Closed</li> <li>• Heat - All heat stages off; Mod Heat output Off</li> <li>• Occupied/Unoccupied/VAV box output - Energized</li> <li>• VOM Relay - Energized</li> </ul>	<b>EMERG_SHUTDOWN:</b> <ul style="list-style-type: none"> <li>• Supply Fan VFD - Min</li> <li>• Relief Fan - Off; Relief Dampers - Closed (if so equipped)</li> <li>• OA Dampers - Closed; Return Damper - Open</li> <li>• Heat - All heat stages off; Mod Heat output Off</li> <li>• Occupied/Unoccupied/VAV box output - Energized</li> <li>• VOM Relay - Energized</li> </ul>
<b>EMERG_FIRE - Input from fire pull box/system:</b> <ul style="list-style-type: none"> <li>• Supply Fan - Off</li> <li>• Supply Fan VFD - Min</li> <li>• Relief Fan - Off; Relief Dampers - Closed (if so equipped)</li> <li>• OA Dampers - Closed; Return Damper - Open</li> <li>• Heat - All heat stages off; Mod Heat output Off</li> <li>• Occupied/Unoccupied/VAV box output - Energized</li> <li>• VOM Relay - Energized</li> </ul>	

## Ventilation Override Module (VOM)

The user can customize up to five different override sequences for purposes of ventilation override control. If more than one VOM sequence is being requested, the sequence with the highest priority is initiated first. Sequence hierarchy is the sequence "A" (UNIT OFF) is first, with sequence "E" (PURGE with Duct Pressure Control) last. A ventilation override mode can be initiated by closing any of the five corresponding binary inputs on the VOM module. A binary output is provided on the VOM module to provide remote indication of an active VOM mode. All compressors, condenser fans and the Humidification output are de-energized for any VOM sequence. The factory default definitions for each mode are as follows:



## Symbio™ 800 Controls

<p><b>UNIT OFF sequence “A”</b> When complete system shutdown is required the following sequence can be used.</p> <ul style="list-style-type: none"> <li>• Supply Fan VFD - Min</li> <li>• Relief Fan - Off; Relief Dampers - Closed (if so equipped)</li> <li>• OA Dampers - Closed; Return Damper - Open</li> <li>• Heat - All heat stages off; Mod Heat output Off</li> <li>• Occupied/Unoccupied/VAV box output - Deenergized</li> <li>• VOM Relay - Energized</li> <li>• Return Fan VFD - Off</li> </ul>	<p><b>PRESSURIZE sequence “B”</b> Perhaps a positively pressurized space is desired instead of a negatively pressurized space. In this case, the supply fan should be turned on with VFD at 100% speed and relief fan should be turned off.</p> <ul style="list-style-type: none"> <li>• Supply Fan - On</li> <li>• Supply Fan VFD - Max</li> <li>• Relief Fan - Off; Relief Dampers - Closed (if so equipped)</li> <li>• OA Dampers - Open; Return Damper - Closed</li> <li>• Heat - All heat stages off; Mod Heat output Off</li> <li>• Occupied/Unoccupied/VAV box output - Energized</li> <li>• VOM Relay - Energized</li> <li>• Return Fan VFD - Off</li> </ul>
<p><b>RELIEF sequence “C”</b> With only the fans running (supply fan off), the space that is conditioned by the rooftop would become negatively pressurized. This is desirable for clearing the area of smoke from the now-extinguished fire, possibly keeping smoke out of areas that were not damaged.</p> <ul style="list-style-type: none"> <li>• Supply Fan VFD - Min</li> <li>• Relief Fan - On; Relief Dampers Open (if so equipped)</li> <li>• OA Dampers - Closed; Return Damper - Open</li> <li>• Heat - All heat stages off; Mod Heat output Off</li> <li>• Occupied/Unoccupied/VAV box output - Deenergized</li> <li>• VOM Relay - Energized</li> <li>• Return Fan VFD - On/100%</li> </ul>	<p><b>PURGE sequence “D”</b> Possibly this sequence could be used for purging the air out of a building before coming out of Unoccupied mode of operation on VAV units or for the purging of smoke or stale air if required after a fire.</p> <ul style="list-style-type: none"> <li>• Supply Fan VFD - Max</li> <li>• Relief Fan - On; Relief Dampers Open (if so equipped)</li> <li>• OA Dampers - Open; Return Damper - Closed</li> <li>• Heat - All heat stages off; Mod Heat output Off</li> <li>• Occupied/Unoccupied/VAV box output - Energized</li> <li>• VOM Relay - Energized</li> <li>• Return Fan VFD - On/100%</li> </ul>
<p><b>PURGE with duct pressure control sequence “E”</b> This sequence can be used when supply air control is required for smoke control.</p> <ul style="list-style-type: none"> <li>• Supply Fan VFD - (If so equipped) Controlled by Supply Air Pressure Control function; Supply</li> <li>• Air Pressure High Limit disabled</li> <li>• Relief Fan - On; Relief Dampers Open (if so equipped)</li> <li>• Heat - All heat stages off; Mod Heat output Off</li> <li>• Occupied/Unoccupied/VAV box output - Energized</li> <li>• VOM Relay - Energized</li> <li>• Return Fan VFD - On/In Control</li> </ul>	

## User Interface (UI)

A 7 inch user interface features a touch-sensitive color screen that provides operating status, performance monitoring, and scheduling changes and operating adjustments.

## Demand Limit

This mode is used to reduce electrical consumption at peak load times. When demand limiting is needed, mechanical cooling and/or heating operation are either partially or completely disabled in order to save energy.

## Frost/Freeze Avoidance

### Evaporator Coil Frost Protection Limit

Temperature and pressure sensors on each refrigeration circuit are used to determine if the coil is approaching a freezing condition. Mechanical cooling capacity is shed as necessary to prevent icing. The Froststat™ system reduces the need for hot gas bypass and utilizes the suction line surface temperature sensor to shed cooling when coil frosting conditions occur. The supply fans are not shut off and will de-ice the coil. Timers prevent the compressors from rapid cycling.

### Steam and Hot Water Coil - Freeze Avoidance

Freeze Avoidance is a feature which helps prevent freezing of steam or hot water heat coils during periods of unit inactivity and low ambient temperatures. Whenever the unit supply fan is off, the outdoor air temperature is monitored. If the temperature falls below a predetermined value, the heating valve is opened to a position selected on the user interface to allow a minimum amount of steam or hot water to flow through the coil and avoid freezing conditions.

## Occupied/Unoccupied Switching

There are two ways to switch between Occupied or Unoccupied:

- Field-supplied contact closure (hard wired binary input to Symbio™ 800 Controls). This input accepts a field supplied switch or contacts closure, such as a time-of-day clock
- Tracer (or third party BAS with LCI or BCI module)
- Local scheduling

## Economizer Controls

### Comparative Enthalpy Control of Economizer

An optional comparative enthalpy system is used to control the operation of the economizer, and measures the temperature and humidity of both return air and outside air to determine which source has lower enthalpy. This system allows true comparison of outdoor air and return air enthalpy by measurement of outdoor air and return air temperatures and humidities.

### Reference Enthalpy Control of Economizer

The optional reference enthalpy compares outdoor air temperature and humidity to the economizer enthalpy control setpoint. If outdoor air temperature and humidity are below the economizer enthalpy control setpoint, the economizer will operate freely. This system provides more sophisticated control where outdoor air humidity levels may not be acceptable for building comfort and indoor air quality.

### Dry Bulb Temperature Control of Economizer

The optional dry bulb system measures outdoor temperature comparing it to the economizer control temperature setpoint. If the outdoor temperature is below the economizer dry bulb temperature control setpoint, the economizer will operate freely. This system is best suited for arid regions where the humidity levels of outside air would not be detrimental to building comfort and indoor air quality.

### Differential Dry Bulb

The optional differential dry bulb system measures outdoor air and compares it to the return air dry bulb temperature. If the outdoor air is below the return air and lower than the economizer enable offset, the economizer will operate freely. This system is best suited for arid regions where humidity levels of outside air would not be detrimental to building comfort and indoor air quality.

## Refrigeration Balanced Starts

Balanced starts is a user-selectable feature through the user interface available on all units without the eFlex™ variable speed option. After each request for compressor operation, the lead refrigeration circuit switches, thereby causing a more equitable or balanced run time among compressors.

## Emergency Stop Input

A binary input is provided for installation of field provided switch or contacts for immediate shutdown of all unit functions.

## Anti-Short Cycle Protection

A standard feature provided to prevent excessive cycling and premature wear of the compressors, contactors and related components.

## High Duct Temperature Limit

Two temperature sensors, Discharge Air and Return Air (if installed) are used to determine if duct temperatures are excessively high. If the discharge air temperature exceeds 200°F or if the return air temperature exceeds 135°F, the unit will be placed into Emergency Stop Mode.

## CO<sub>2</sub> Control - Demand Control Ventilation (DCV)

A ventilation reset function that provides the necessary ventilation for occupants and reduces energy consumption by minimizing the outdoor air damper position (or the OA flow setpoint with Traq) below the Building Design Minimum, while still meeting the ASHRAE Std 62.1 ventilation requirements.

- If the space CO<sub>2</sub> level is greater than or equal to the CO<sub>2</sub> Design Setpoint, the outdoor air damper will open to the Design Min Outdoor Air Damper (or OA Flow) Setpoint. If there is a call for economizer cooling, the outdoor air damper may be opened further to satisfy the cooling request.
- If the space CO<sub>2</sub> level is less than or equal to the CO<sub>2</sub> Minimum Setpoint, the outdoor air damper will close to the DCV Minimum Outdoor Air Damper (or OA Flow) Setpoint. If there is a call for economizer cooling, the outdoor air damper may be opened further to satisfy the cooling request.
- If the space CO<sub>2</sub> level is greater than the CO<sub>2</sub> Minimum Setpoint and less than the CO<sub>2</sub> Design Setpoint, the outdoor air damper position is (or OA flow) modulated proportionally to the Space CO<sub>2</sub> level relative to a point between the CO<sub>2</sub> Min Setpoint and the CO<sub>2</sub> Design Setpoint. If there is a call for economizer cooling, the outdoor air damper may be opened further to satisfy the cooling request.

**Note:** CO<sub>2</sub> sensor used with Demand Control Ventilation must be powered from an external power source or separate 24 VAC transformer.

**Figure 3. CO<sub>2</sub> control**

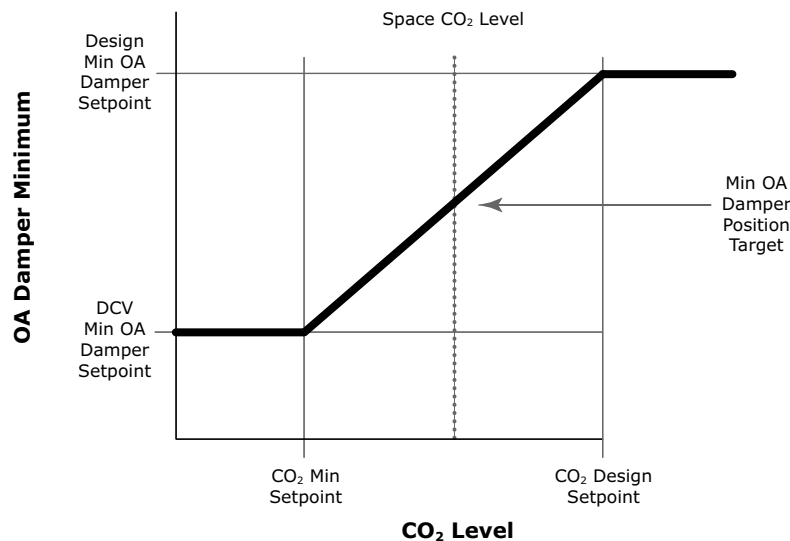

## Low Charge Protection

A refrigerant charge estimate is calculated using a combination of measured temperatures, calculated saturated temperatures, refrigerant mass flow and the expansion valve opening. At the touch screen interface, a warning diagnostic is displayed when a low charge has been detected on the circuit, but is not critical enough to force a circuit shutdown. When a critical low charge has been detected on the circuit, a circuit shut down is triggered, and a shutdown diagnostic is displayed at the touch screen interface. Other diagnostic messages include the following:

- A diagnostic message displayed at the user interface, warning of a low charge situation when the unit is just slightly undercharged. The unit will be allowed to run.
- A diagnostic message displayed at the user interface, warning of a low charge situation when the unit is undercharged. The undercharged circuit will be locked out to protect the compressors.

## Condenser Fan

The Symbio™ 800 controller cycles or modulates condenser fans based on ambient temperature and saturated condensing temperature to ensure the optimum operating conditions for the unit.

## LonTalk® Building Automation System

The LonTalk® communication protocol for the Symbio™ 800 controller expands communications from the unit UCM network to a Tracer® Ensemble™ building automation system or third party building automation system. Utilizing LonTalk®, the BAS allows external setpoint and configuration adjustment and monitoring of status and diagnostics. The Symbio™ 800 utilizes an FTT-10A free topology transceiver, which supports non-polarity sensitive, free topology wiring—which in turn allows the system installer to utilize star, bus, and loop architectures. This controller works in standalone mode, peer-to-



peer with one or more other units, or when connected to a Tracer® Ensemble™, Tracer SC+, or a third party building automation system that supports LonTalk®. The LON controller is available as a factory or field-installed kit.

## **BACnet® Building Automation Control Network**

The BACnet® control network for Symbio™ 800 expands communications from the unit controller network to the Tracer® Ensemble™ or Tracer SC+ building automation system or third party building automation system. Utilizing BACnet, the BAS allows external setpoint and configuration adjustment and monitoring of status and diagnostics. The Symbio™ 800 utilizes the BACnet defined MS/TP protocol as defined in ASHRAE standard 135-2004. This controller works in standalone mode, with Tracer® Ensemble™, Tracer SC+ or when connected to a third party building automation system that supports BACnet.

## **AirFi® Wireless Communication Interface**

Trane AirFi® Wireless Communication replaces the BACnet communication link and sensor wire on Tracer® building automation systems for faster, easier, lower-risk installation and life-cycle savings.

The Air-Fi Wireless Communications Interface (WCI) enables wireless communications between system controls, unit controls, and wireless sensors for Trane control products that use the BACnet® protocol. The WCI replaces the need for communications wire in all system applications. The Air-Fi® Wireless Communications Sensor (WCS) is compatible with any Trane controller that uses a WCI. The WCS provides the same functions as many currently available Trane wired sensors. No further software or hardware is necessary for site evaluation, installation, or maintenance.

Adherence to ANSI/ASHRAE® Standards 125-2016 (BACnet Zigbee®), enables secure and reliable wireless monitoring and control over commercial building systems. It also conforms to the IEEE® 802.15.4 standard, which ensures that your wireless BAS Communication system will reliably coexist with other wireless systems, including Bluetooth and Wi-Fi.

## **Modulating Hot Gas Reheat for Dehumidification**

Modulating hot gas reheat involves adding a refrigerant-to-air heat exchanger downstream of the evaporator (cooling) coil. A valve diverts the hot refrigerant vapor leaving the compressor through this heat exchanger to reheat the dehumidified air leaving the evaporator coil. This allows the use of heat that is recovered from the refrigeration circuit of the rooftop unit to reduce system operating costs by avoiding the use of “new” energy for reheat.

The main function of the IntelliPak® rooftop unit is to provide zone temperature control. While modulating hot gas reheat will improve dehumidification performance at part-load conditions, it does not function as a standalone dehumidifier. In general, hot gas reheat requires a call for cooling to initiate. If there is a need for dehumidification when there is no need for sensible cooling, another solution may need to be investigated. IntelliPak packaged rooftop systems include non-standard solutions that might be considered for these applications.

Applications which should be investigated before using the standard modulating hot gas reheat option include:

- Process humidity control applications
- Makeup air or 100% outdoor air
- Zones with dramatically varying load conditions (sanctuaries, locker rooms, gymnasiums, etc.)

## **Low Ambient Compressor Lockout**

This function will lock out the compressor if the outdoor air temperature is below the low ambient compressor lock out temperature setpoint. The factory setpoint is 50°F on standard units and 0°F on low ambient units. This setpoint is adjustable at the user interface. Compressors will be locked out when outdoor air temperatures fall below the selected temperature and will be allowed to start again when temperatures rise 5°F above the setpoint.

## **Isolation Damper Control**

The Symbio™ 800 supports field installed discharge and/or return isolation dampers including damper parameter setup, damper command, position status and associated alarms.



## Refrigerant Detection and Mitigation

Equipment with R-454B refrigerant requires a refrigerant detection system. When the refrigerant detection system is in a normal state, the equipment provides normal heating, cooling, and ventilation.

The refrigerant sensor creates an alarm signal when the sensed refrigerant concentration has exceeded the refrigerant concentration alarm threshold. The alarm threshold is a non-adjustable preset value. Refrigerant concentration is read and reported from the leak detector.

While the refrigerant detection system is in an alarm state, the equipment is required to mitigate the alarm condition for a minimum of 5 minutes after the refrigerant detection system has reset to a normal state.

In the event the control system detects the refrigerant sensor has failed, become disconnected or unpowered; controls will respond with a diagnostic and mitigation becomes active. The unit shall operate to provide mitigation actions for the duration of the sensor failure mode. The supply fan will operate continuously, and all compressor operation is disabled. In heating modes of operation, non-compressor heating and ventilation are allowed to maintain space comfort. Economizer cooling operation is also allowed.



# Application Consideration

## Clearance Requirements

The recommended clearances identified in “[Dimensional Data](#),” p. 134 should be maintained to assure adequate service capability, maximum capacity and peak operating efficiency. A reduction in unit clearance could result in condenser coil starvation or warm condenser air recirculation. If the clearances shown are not possible on a particular job, consider the following:

- Do the clearances available allow for major service work such as changing compressors or coils?
- Do the clearances available allow for proper outside air intake, relief air removal, and condenser airflow?
- If screening around the unit is being used, is there a possibility of air recirculation from the relief to the outside air intake, or from condenser exhaust to condenser intake?
- Do clearances meet all applicable codes?

Actual clearances which appear inadequate should be reviewed with a local Trane sales engineer.

When two or more units are to be placed side by side, the distance between the units should be increased to 150 percent of the recommended single unit clearance. The units should also be staggered for the following reasons:

- To reduce span deflection if more than one unit is placed on a single span. Reducing deflection discourages sound transmission.
- To assure proper diffusion of relief air before contact with the outside air intake of adjacent unit.

**Note:** Refer to “[Dimensional Data](#),” p. 134 for specific clearance requirements.

## Efficiency Offerings

### High Efficiency

Trane offers a high-efficiency option for 20 to 90 ton units. This option is especially helpful in meeting high efficiency requirements legislated by some states, as well as qualifying for local utility rebates.

### eFlex™ Variable Speed

A state of the art Trane eFlex™ variable speed compressor is combined with fixed capacity compressors to provide a superior part load efficiency (IEER) option. Compressor designs are optimized and selected to maximize part load performance. Continuous capacity from 15-100% means that discharge air temperature is controlled within +/-1°F. This eliminates discharge air temperature swings caused by cycling fixed capacity compressors, improves humidity control, and leads to increased comfort in the space.

**Note:** Available on 20 to 75 ton units.

## Supply Fan Flexibility

Trane offers two types of supply fans as options for 20 to 75 ton units. These units may be ordered with a traditional belt-driven, forward-curved (FC) fan or with a beltless direct-drive plenum (DDP) fan. The DDP fans offer multiple width options to optimize fan efficiency for the system design point. DDP fans offer increased reliability and require less maintenance than FC fans because there are no belts to tension or replace, no bearings to grease, and no sheaves to align.

## Relief/Return Fan Options

The Trane 100% modulating relief system with Statitrac is an excellent choice for controlling building pressure. With a relief fan system, the supply fan motor and drives must be sized to overcome the total system static pressure, including return losses, and pull return air back to the unit during non-economizer operation.

Trane's 100% modulating return fan system with Statitrac is an excellent choice for systems with high return static pressure losses. In a return fan system, the return fan works in series with the supply fan,



## Application Consideration

---

and operates continuously whenever the supply fan is operating to maintain return air volume. The return fan motor and drives are sized to pull the return CFM back to the unit based on return duct static. Therefore, with a return fan system, the supply fan ordinarily requires less horsepower than a system with a relief fan.

Either return or relief fan systems with Statitrac may be used on any rooftop application that has an outdoor air economizer.

### Relief/Return Fan Systems

Reasons for selecting either return or relief fan systems include economy, building pressure control, code requirements, and generally accepted engineering practices.

- Barometric relief
- 100% modulating relief with Statitrac
- 100% modulating plenum return airfoil fan with Statitrac

### Barometric Relief Dampers

This approach uses non-motorized, gravity-operated relief dampers that are located in the return-air section of the rooftop unit. When the building pressure increases, the pressure inside the return-air section also increases, eventually forcing open the relief dampers and allowing air to leave the building.

Barometric relief dampers are typically used in small buildings that use an open ceiling plenum for the return-air path. They are relatively inexpensive and require no sensors or controls, but they may require the building pressure to increase significantly before relieving sufficient airflow.

### Modulating Relief Fan with Statitrac™

This approach uses a powered relief fan located inside the return-air section of the rooftop unit. The fan is sized to relieve up to 100 percent of the nominal supply fan airflow, and its capacity is modulated to maintain measured building pressure at a desired setpoint.

The Trane Statitrac™ control system uses a differential pressure transducer to compare indoor (building) static pressure to atmospheric (outdoor) static pressure. The relief fan is turned on whenever needed to relieve air, then modulates the speed of the relief fan (or modulates the position of discharge dampers) to control the building pressure within the adjustable deadband, which can be set at the user interface.

The Trane modulating relief fan with Statitrac provides efficient control of building pressure. The relief fan operates only when needed to lower building pressure, meaning that in some buildings it may only need to operate when the unit is airside economizing. By directly measuring building pressure, the modulating relief fan can respond to pressure changes caused by wind, stack effect, the intermittent operation of local relief fans, and demand-controlled ventilation.

### 100% Modulating Return Fan Systems with Statitrac Control

A differential pressure control system, Statitrac, uses a differential pressure transducer to compare indoor building pressure to atmospheric pressure.

The return fan relief dampers are modulated, based on space pressure, to control the building pressure to within the adjustable, specified deadband that is set at the user interface. A VFD modulates the return fan speed based on return duct static pressure.

#### Advantages

- The return fan operates independently of the supply fan to provide proper balance throughout the airflow envelope.
- Statitrac compensates for pressure variations within the building from remote relief fans and makeup air units.
- The return fan acts as both relief and return fan based on operation requirements.

The Trane 100% modulating return system with Statitrac provides efficient control of building pressure in applications with higher return duct static pressure and applications requiring duct returns. Relief discharge dampers are controlled directly from building pressure, return fan VFD is controlled from

return static pressure, and return/economizer dampers are controlled based on ventilation control and economizer cooling requests.

## Horizontal Supply and Return

The typical rooftop installation has both the supply and return air paths routed through the roof curb and building roof. However, many rooftop installations require horizontal supply and/or return from the rooftop because of a building's unique design or for acoustic considerations.

This horizontal supply and return option applies to 20-75 tons SXHP, SFHP, SLHP, and SSHP, and 90-130 tons SXHR, SLHR, and SSHR design units. For this option, the standard downflow discharge and return openings are blocked. Access panels are removed in the field as indicated in . These openings are used for the discharge and return. No special curb is needed.

When using an IntelliPak™ rooftop for horizontal supply and return, an additional pressure drop must be added to the supply external static to account for the 90 degree turn by the air. This additional pressure drop depends on airflow and rooftop size, but a range of 0.10 inches to 0.30 inches can be expected. The openings on the rooftop all have a one inch lip around the perimeter to facilitate ductwork attachment. If relief/return fans are being used on an IntelliPak™ rooftop unit with horizontal return, provisions should be made for accessing the relief components, since the access door opening is now being used as a return duct opening. The return ductwork attachment to the rooftop can include a section of removable duct. Use the dimensions provided and the supply and relief cfm to calculate the velocity (ft/min) through the openings.

Downflow units can be converted to horizontal supply and/or return in the field with special field-supplied curbs that use the unit's standard discharge and return openings. The supply and return air is routed through the curb to horizontal openings on the sides of the curb.

**Note:** 90-130 ton horizontal return with a return fan must be handled through design specials. Fan airflow cannot be field converted.

### 20 to 75 Ton Units

To supply air horizontally, the panels that normally house the heat accessory controls (Panel A) and the gas heat barometric dampers (Panel B) can be removed and either of the openings used as a unit discharge (see note 1). To return air horizontally, the relief fan access door (Panel C) can be removed and used as a return opening. [Table 2, p. 30](#), [Table 3, p. 31](#), and [Table 4, p. 31](#) show dimensions for those panels (see note 4).

**Note:** Horizontal discharge cannot be applied to SFHP 20-55 ton units with DDP fan.

The SXHP (extended casing cooling only), SFHP (gas heat), SSHP (steam heat), and SLHP (hot water heat) rooftops can be factory modified for horizontal supply and return air without the use of a horizontal supply/return curb. To supply air horizontally on SXHP only, the panels that normally house the heat accessory controls (Panel A) and the gas heat barometric dampers (Panel B) can be removed and either of the openings used as a unit discharge. To return air horizontally, the relief fan access door (Panel C) can be removed and used as a return opening (see note 4).

**Figure 4. Horizontal discharge panel dimensions – SXHP, SFHP, SLHP, SSHP units (20 to 75 tons)**

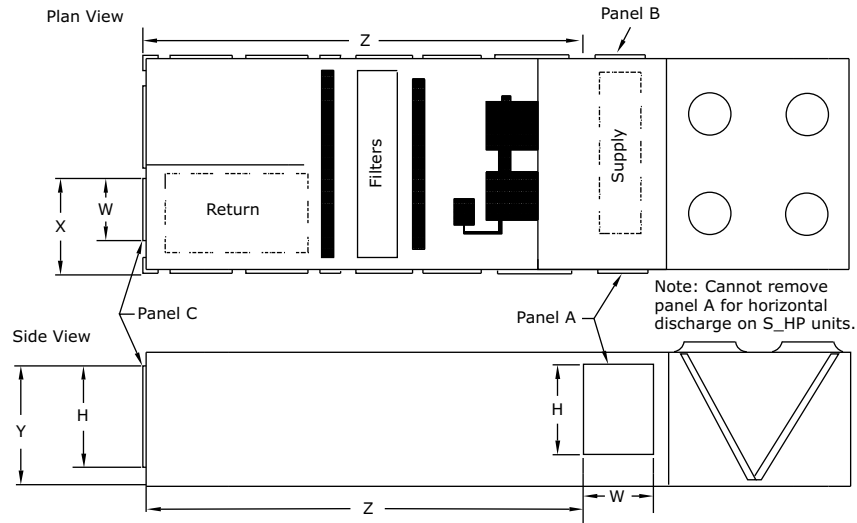

**Notes:**

1. For horizontal discharge on SFHP, SLHP and SSHP units, only the Panel B can be removed. Panel A cannot be used due to the location of the heating piping and components.
2. Add an extra 0.20-inches pressure drop to the supply external static to account for the extra turn the air is making.
3. The openings all have a 1.25-inch lip around the perimeter to facilitate ductwork attachment.
4. If relief fans are being used, provisions should be made for access to the relief components, since the access door is now being used as a return.
5. Use the dimensions provided and the supply cfm to calculate the velocity (ft/min) through the openings to be sure they are acceptable coils.

**Table 2. SXHP, SFHP, SSHP, SLHP– Panel A and B dimensions**

Model	H (in.) <sup>(a)</sup>	W (in.) <sup>(a)</sup>	Total Area (H x W)	
			(in. <sup>2</sup> )	(ft <sup>2</sup> )
S*HP *20	40.7	25.5	1038	7.2
S*HP *25	40.7	25.5	1038	7.2
S*HP *30	52.7	25.5	1344	9.3
S*HP *40	64.5	34.5	2225	15.5
S*HP *50	76.7	34.5	2646	18.4
S*HP *55	76.7	34.5	2646	18.4
S*HP *60	64.6	34.5	2229	15.5
S*HP *70	64.6	34.5	2229	15.5
S*HP *75	64.6	34.5	2229	15.5

**Note:** \* = Universal letter/number. See model number for specifics.

<sup>(a)</sup> Dimensions include a 1.25 inch lip around perimeter. See Horizontal discharge panel dimensions, Note 3.

**Table 3. SXHP, SFHP, SSHP, SLHP – Panel C dimensions**

Model	H (in.) <sup>(a)</sup>	W (in.) <sup>(a)</sup>	Total Area (H x W)	
			(in. <sup>2</sup> )	(ft <sup>2</sup> )
S*HP *20	40.7	34.5	1404	9.8
S*HP *25	40.7	34.5	1404	9.8
S*HP *30	52.7	34.5	1818	12.6
S*HP *40	64.5	34.5	2225	15.5
S*HP *50	76.7	34.5	2646	18.4
S*HP *55	76.7	34.5	2646	18.4
S*HP *60	64.6	34.5	2229	15.5
S*HP *70	64.6	34.5	2229	15.5
S*HP 75	64.6	34.5	2229	15.5

**Note:** \* = Universal letter/number. See model number for specifics.

<sup>(a)</sup> Dimensions include a 1.25 inch lip around perimeter. See Horizontal discharge panel dimensions, Note 3.

**Table 4. SXHP, SFHP, SSHP, SLHP – X, Y, and Z dimensions**

Model	X (in.)	Y (in.)	Z (in.)
S*HP *20	43.5	44.0	201.5
S*HP *25	43.5	44.0	201.5
S*HP *30	43.5	56.0	201.5
S*HP *40	44.5	67.8	237.0
S*HP *50	44.5	80.0	237.0
S*HP *55	44.5	80.0	237.0
S*HP *60	44.5	68.0	237.5
S*HP *70	44.5	68.0	237.5
S*HP 75	44.5	68.0	237.5

**Note:** \* = Universal letter/number. See model number for specifics.

## 90 to 130 Ton Units

Figure 5, p. 32 is a simplified sketch showing which panels can be used for horizontal supply and/or return. On 90 to 130 ton units, only one side of the extended casing may be used for horizontal supply because of the location of the unit control panel. There are, however, two panels on SXHP models (Panels A) on the side opposite the control box that can be removed along with the vertical support, which separates the two. Removal of the vertical support is optional, but will ensure maximum airflow. On SLHP and SSHR models, only one of the Panel As can be used for horizontal supply because of the location of the heating coil. Horizontal return is accomplished in much the same way as on S\*HPs by removing the relief fan access door (Panel B). See Table 5, p. 32 and Table 6, p. 32 for S\*HR panel dimensions (see note 4).

The SXHR, SLHR, SSHR rooftops can be factory modified to supply and return air horizontally without the use of a horizontal supply/return curb. To supply air horizontally, use panel A only. The panel on the opposite side cannot be used due to the location of the unit control panel. SXHR rooftop air conditioners do not have a panel configuration like the 20-89 ton rooftops.

To achieve maximum airflow, vertical support can be removed after the unit has been placed on the roof curb. It is secured by four screws. (See note 1) For horizontal discharge on SLHR and SSHR units, only the panel A next to the condenser fan section can be removed. The other panel A next to the supply fan cannot be used due to the location of the heating coils. To return air horizontally, the relief fan access door (panel B) can be removed and used as a return opening (see note 4).

**Figure 5. Horizontal discharge panel dimensions – 90 to 130 tons SXHR, SLHR, SSHR units**

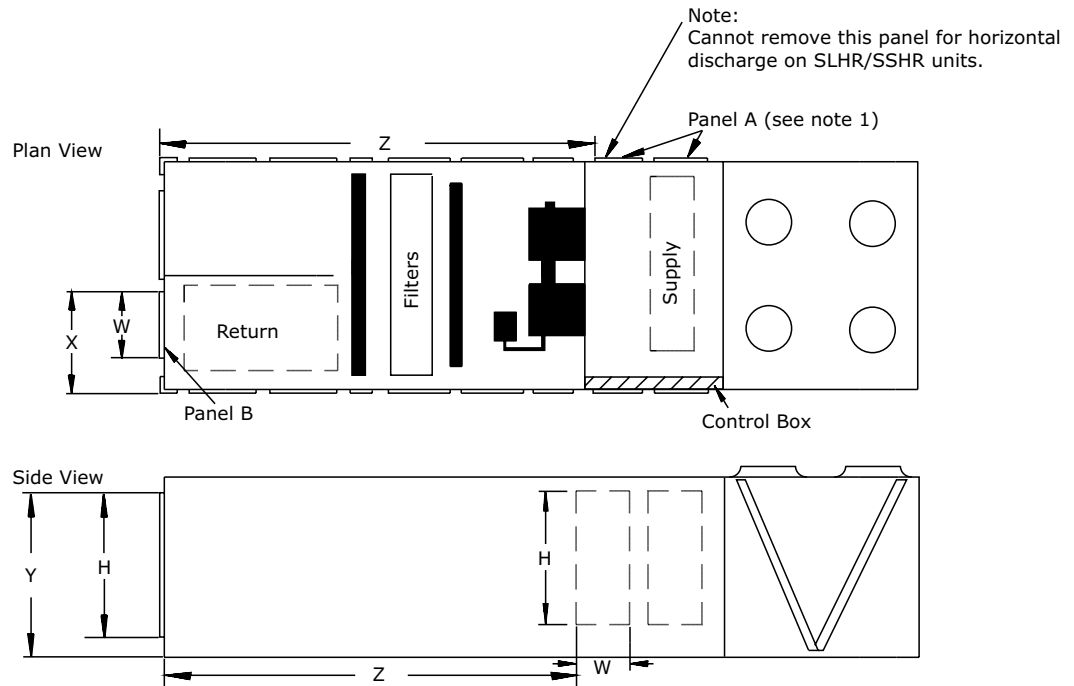

**Notes:**

1. SXHR units have two Panel As that can be removed. Once unit is installed, the panel(s) and the 6.5-inch vertical support channel in between can be removed.
2. Add an extra 0.20-inches pressure drop to the supply external static to account for the extra turn the air is making.
3. The openings all have a 1.25-inch lip around the perimeter to facilitate ductwork attachment.
4. If relief/return fans are being used, provisions should be made for access to the relief components, since the access door is now being used as a return.
5. Use the dimensions provided and the supply cfm to calculate the velocity (ft/min) through the openings to be sure they are acceptable coils.

**Table 5. SXHR, SLHR, SSHR- Panel A and B dimensions**

Panel	H (in.)	W (in.)	Total Area (H X W)	
			(in. <sup>2</sup> )	(ft <sup>2</sup> )
A	72.7	27.5	1999	13.9
B	72.7	32.0	2508	17.4

**Table 6. SXHR, SLHR, SSHR - X, Y, Z dimensions**

Model	X (in.)	Y (in.)	Z (in.)
S*HR 90-130	69.0	77.8	244.7

**Note:** Not available with gas or electric heat.

## Acoustic Considerations

The best time to make provisions to reduce sound transmission to the occupied space is during the project design phase. Proper placement of rooftop equipment is critical to reducing sound transmitted into the building. The most economical means of avoiding an acoustical problem is to locate rooftop



equipment away from acoustically-sensitive areas. If possible, locate rooftop equipment above corridors, utility rooms, restrooms, or other areas where higher sound levels are acceptable.

It is not possible to totally quantify the effect of the building structure on sound transmission, since this depends on the response of the roof and building members to the sound and vibration of the unit components. However, the following guidelines have been proven through experience to help reduce sound transmission through the building structure:

- Never cantilever the condensing section of the rooftop unit; a structural cross member must support this end of the unit.
- Locate the unit's center of gravity close to (or over) a column or main support beam to minimize roof deflection and vibration-related noise.
- If the roof structure is very light, roof joists should be replaced by a structural shape in the critical areas described above.
- If several units are to be placed on one span, they should be staggered to reduce deflection over that span.

In addition, the Trane Acoustics Program™ (TAP) allows for modeling of various sound paths to predict sound levels in the occupied space. The software models airborne sound from supply- and return-air paths, as well as duct breakout and roof transmission sound, so that the designer can identify potential sound problems and make design alterations before equipment installation. TAP is also capable of modeling the effect of outdoor sound on adjacent properties. This program is available at [www.trane.com](http://www.trane.com). Ask your local Trane representative for additional information.

## Corrosive Atmospheres

Trane's IntelliPak™ Rooftops are designed and built to industrial standards and will perform to those standards for an extended period depending on the hours of use, the quality of maintenance performed, and the regularity of that maintenance.

One factor that can have an adverse effect on unit life is operation in a corrosive environment. Since the Microchannel condenser coil is an all-aluminum design, it provides a high level of corrosion protection on its own. Uncoated, it withstands a salt spray test in accordance with ASTM B117 for 1,000 hours. When rooftops are operated in highly corrosive environments, Trane recommends the corrosion protected condenser coil option.

This corrosion protection option meets the most stringent testing in the industry, including ASTM B117 Salt Spray test for 6,000 hours and ASTM G85 A2 Cyclic Acidified Salt Fog test for 2,400 hours. The acid fog test is the most stringent available today. This coating is added after coil construction covering all tubes, headers, fins and edges. The design provides superior protection from any corrosive agent.

IntelliPak paint innately handles harsh weather, including most coastal and salt environments and direct sun. The unit paint was salt spray tested in accordance with ASTM B117 and UV weathering resistance tested in accordance with ASTM G155 Test cycle 1 for 2000 hours. For further detail on the paint testing, refer to *Paint and Coatings Analysis - Sales Brochure* (PROD-SLB034\*-EN).

**Note:** Field coating is not allowed on Microchannel coils.

## Ventilation Override Sequences

Trane can provide five (5) different ventilation override sequences on IntelliPak™ rooftops. For convenience, the sequences are factory preset but are fully field edited from the user interface or Tracer TU. Any or all five sequences may be "locked" in by the user at the user interface.

Typically, a manual switch is used and located near the fire protection control panel. This enables the fire department access to the control for use during or after a fire. It is also possible to initiate the sequence from a field-installed automatic smoke detector. In either case, a contact closure begins the ventilation override control sequence.

The user can customize up to five (5) different override sequences for purposes such as smoke control. The following parameters within the unit can be defined for each of the five sequences:

- Supply Fan - on/off
- Variable Frequency Drives - on (60 Hz)/off (0 Hz)/controlling
- Relief/Return Fan - on/off



## Application Consideration

---

- Relief Air Dampers - open/closed
- Outdoor Air Dampers - open/closed
- Heat - off/controlling (output for) VAV Boxes - open/controlling

Compressors and condenser fans are shut down for any Ventilation Override sequence. Factory preset sequences include unit Off, Relief, Purge, Purge with duct pressure control, and Pressurization. Any of the user-defined Ventilation Override sequences can be initiated by closing a field supplied switch or contacts connected to an input on the Ventilation Override Module. If more than one ventilation override sequence is being requested, the sequence with the highest priority is initiated. Refer to the Ventilation Override Mode (VOM) information in the Control section of this catalog for more details on each override sequence.

## Natural Gas Heating Considerations

Trane uses stainless steel throughout the construction of its IntelliPak™ natural gas drum and tube heat exchangers.

These heat exchangers can be applied with confidence, particularly with full modulation control, when mixed air temperatures are below 50°F, and low ambient temperatures can cause condensation to form on the heat exchanger. The natural gas heat exchangers are not recommended for applications with mixed air conditions entering the heat exchanger below 30°F to ensure adequate leaving air heating temperature. For airflow limitations and temperature rise across the heat exchanger information, see Natural Gas Heating Capacities table in Performance Data.

## High Entering Return Temperature Applications

Some applications may have high entering return temperatures. It is recommended that the dry bulb temperatures in any application not exceed 95°F for extended periods of time. If this is a requirement, please work with the Applications or Product Support group in developing a specific assessment. Other factors, such as wet bulb and ambient temperatures, will also affect the system's reaction.

## A2L Application Considerations

This product is listed to UL standard 60335-2-40, Household and Similar Electrical Appliances – Safety – Part 2-40: Particular Requirements for Electrical Heat Pumps, Air-Conditioners and Dehumidifiers, which defines safe design and use strategies for equipment using A2L refrigerants. This standard limits the refrigerant concentration in a space in the event of a refrigerant leak. To meet the requirements, the UL standard defines minimum room area, refrigerant charge limit, minimum circulation airflow and/or ventilation airflow requirements, and limits the use of ignition sources in spaces. The standard may require a unit refrigerant leak detection system.

For equipment with R-454B and charge amounts less than or equal to 3.91 lbs per circuit, this UL standard does not prescribe a room area limit and does not require a refrigerant leak detection system or any circulation airflow or ventilation airflow mitigation strategies. However, ignition sources in ductwork must be evaluated.

Depending on the application, a specific requirement of ANSI/ASHRAE Standard 15, Safety Standard for Refrigeration Systems, could be more stringent than UL 60335-2-40 requirements. See *Refrigeration Systems and Machinery Rooms Application Considerations for Compliance with ASHRAE® Standard 15-2022 Application Engineering Manual* (APP-APM001\*-EN) for more information.

## Minimum Room Area Limits (Refrigerant charge greater than 3.91 lb per circuit)

Equipment with R-454B charge amounts greater than 3.91 lb per circuit may require additional circulation or ventilation airflow mitigation strategies. In this case, two minimum room area ( $A_{min}$ ) thresholds:

- The first threshold defines when equipment serving a single room is required to provide circulation airflow, either continuous or activated by a leak detection system. A ducted system requires circulation airflow unless the smallest room it serves is larger than the adjusted  $A_{min}$  threshold. This product contains a leak detection system if a circuit charge is greater than 3.91 lbs. As a result, no further leak detection system evaluation is required.

- The second threshold defines when additional ventilation airflow is required. If the room area, A or TA, is below the adjusted  $A_{min}$  or  $TA_{min}$  threshold, additional ventilation is required to remove refrigerant in the event of a leak. Refer to UL 60335-2-40 Clause GG.8 and ANSI/ASHRAE Standard 15 Section 7 for natural and mechanical ventilation requirements. For minimum room area, see equipment nameplate or unit Installation, Operation, and Maintenance (IOM) manual.

### Minimum Room Area ( $A_{min}$ ) Adjustments

- Altitude:** The  $A_{min}$  threshold changes with altitude. Multiple the altitude adjustment factor in the following table by  $A_{min}$  shown on the unit nameplate or in the Installation, Operation, and Maintenance (IOM) manual.

**Table 7. Altitude adjustment factor**

Altitude (ft)	Sea Level to 2000	2001 to 4000	4001 to 6000	6001 to 8000	8001 to 10000	10001 to 12000	12001 to 14000	14001 to 15000	Over 15000
$A_{min}$ Adjustment	1	1.05	1.11	1.17	1.24	1.32	1.41	1.51	1.57

- Height :**  $A_{min}$  can be adjusted if the unit is installed in a room at a height higher than the minimum height shown on the unit. Multiply  $A_{min}$  by the ratio of the unit minimum release height (in meters) / actual release height (in meters).
- Institutional Occupancies:** For institutional occupancies, ASHRAE Standard 15 applies an additional adjustment factor, FOCC, to the amount of charge allowed in a space. To calculate the adjusted  $A_{min}$  for institutional occupancies, divide the  $A_{min}$  on the nameplate by 0.5.

### Determining Room Area (A or TA)

The room area (A) is the room area enclosed by the projection to the floor of the walls, partitions, and doors of the space that the equipment serves. For ducted systems, total room area (TA) of all rooms connected by ducts, may be used instead of A.

Rooms connected by drop ceilings only are not considered a single room.

Rooms on the same floor of the building, and connected by an open passageway, can be considered part of the same room if the passageway is a permanent opening, extends to the floor and is intended for people to walk through.

Adjacent rooms on the same floor of the building and connected by permanent openings in the walls and/or doors between rooms (including gaps between the wall and the floor), can be considered part of the same room if the openings meet the following criteria.

- The opening is permanent and cannot be closed.
- Openings extending to the floor, such as door gaps, need to be at least 20 mm above the floor covering surface.
- Natural ventilations opening areas must meet the requirements of ANSI/ASHRAE Standard 15-2022, Section 7.2.3.2.

Rooms that are connected by a mechanical ventilation system can be considered a single room area if the mechanical ventilation system meets the requirements of ANSI/ASHRAE Standard 15-2022, Section 7.6.4.

### Leak Detection System (Refrigerant charge greater than 3.91 lb per circuit)

The leak detection system consists of one or more refrigerant detection sensors. When the system detects a leak, the following mitigation actions will be initiated until refrigerant has not been detected for at least 5 minutes:

- Energize the supply fan(s) to deliver a required minimum amount of circulation airflow.
- Disable compressor operation.
- Provide an output signal to fully open all zoning dampers, such as VAV boxes.
- Provide an output to energize additional mechanical ventilation (if needed).



## Application Consideration

---

- Units without airflow proving will disable electric heat sources.

Building fire and smoke systems may override this function.

If the refrigerant sensor has a fault, is at the end of its life, or is disconnected, the unit will initiate the mitigation actions. Mitigation actions may be verified by disconnecting the sensor.

The refrigerant sensors do not need service. Use only manufacturer-approved sensors when replacement is required.

## Modulating Hot Gas Reheat

Often supply fan VAV modulation, staged compressor control, or the addition of an eFlex™ variable speed compressor are sufficient in handling building humidity in a wide range of indoor load conditions. Applications where non-peak load conditions can be dominated by latent loads are candidates for the Hot Gas Reheat option. This includes many applications subject to ASHRAE Standard 62 requirements.

When a Hot Gas Reheat coil is energized, it increases the air temperature after exiting the evaporator coil. While this provides dehumidification, this is not a dehumidifier. The main function of the Packaged RTU is to provide zone temperature control. For times when dehumidification is needed, the hot gas reheat will be energized.

Applications which should be investigated before using the standard modulating hot gas reheat option, and will require additional investigation include the following:

- Process applications
- Units utilized as a make-up air or 100% outside air units
- Zones with dramatically varying load conditions (sanctuaries, locker rooms, gymnasiums, etc.)

Generally, the standard Modulating Hot Gas Reheat option requires a call for cooling to initiate. If there is no call for cooling, and there is a desire for dehumidification, another solution will need to be investigated. The IntelliPak™ packaged rooftop systems include non-standard solutions which can be considered for these types of applications.

## IntelliPak™ Replacement Unit (IRU)

This option must be included when replacing an existing R-22 IntelliPak™ unit with the current R-454B design and is also applied when using a full perimeter curb with isolation. *IntelliPak™ Rooftop 20 to 130 Tons, R-410A – Engineering Bulletin (RT-PRB027\*-EN)* provides more detail on this.



# Selection Procedure

This section outlines a step-by-step procedure that may be used to select a Trane air-cooled single-zone air conditioner. Air-cooled models should be selected based on dry bulb (DB) conditions. For specific model selection, utilize TSA or contact the local Trane Sales Office. This sample selection is based on the following conditions:

Summer Design	
Summer outdoor design conditions	95 DB/76 WB ambient temperature
Summer room design conditions	78 DB/64 WB
Total cooling load	430 MBh (35.8 tons)
Sensible cooling load	345 MBh (28.8 tons)
Outdoor air ventilation load	66.9 MBh
Return air temperature	80 DB/65 WB
Winter design:	
Winter outdoor design conditions	0°F
Return air temperature	70°F
Total heating load	475 MBh
Winter outdoor air ventilation load	133 MBh
Air delivery data:	
Supply fan CFM	17,500 CFM
External duct static pressure	1.2 in wg
Minimum outdoor air ventilation	1,750 CFM
Relief/Return fan CFM	12,000 CFM
Return air duct negative static pressure	0.65 in wg
Electrical characteristics:	
Voltage/cycle/phase	460/60/3
Unit Accessories	<ul style="list-style-type: none"> <li>• Gas fired heat exchanger - high heat module</li> <li>• Throwaway filters</li> <li>• Economizer</li> <li>• Modulating 100% relief/return fan</li> </ul>

## Cooling Capacity Selection

1. Determine nominal unit size selection

A summation of the peak cooling load and the outside air ventilation load shows: 430 MBh + 66.9 MBh = 496.9 MBh required unit capacity., a 50 ton unit capacity with standard efficiency evaporator coil at 80 DB/65WB, 95°F outdoor air temperature and 17,500 total supply CFM is 581 MBh total and 430 MBh sensible. Thus, a nominal 50 ton unit with standard efficiency is selected.

2. Determine evaporator coil entering conditions

Mixed air dry bulb temperature determination:

Using the minimum percent of OA (1,750 CFM ÷ 17,500 CFM = 10 percent), determine the mixture dry bulb to the evaporator.

$$RADB + \% OA (OADB - RADB) = 80 + (0.10) (95 - 80) = 80 + 1.5 = 81.5^{\circ}F$$

Approximate wet bulb mixture temperature:

$$AWB + \% OA (OAWB - RAWB) = 65 + (0.10) (76 - 65) = 65 + 1.1 = 66.1^{\circ}F$$

## Selection Procedure

### 3. Determine supply fan motor heat gain

Having selected a nominal 50 ton unit, the supply fan bhp can be calculated. The supply fan motor heat gain must be considered in final determination of unit capacity.

Determine unit total static pressure (Table 56, p. 119) at design supply CFM:

**Table 8. Determine unit total static pressure at design supply CFM**

<b>Supply Air Fan</b>	
Supply Duct Static Pressure	1.20 inches
Evaporator Coil	0.60 inches
Return Duct Negative Static Pressure	0.65 inches
Heat Exchanger	0.31 inches
Throwaway Filter	0.10 inches
Economizer w/ relief Fan	0.12 inches
Trane® Roof Curb	0.13 inches
Unit Total Static Pressure	3.11 inches

Using total of 17,500 CFM and total static pressure of 3.11 inches, estimate the bhp and rpm using the fan curve in , for an FC fan. The bhp is 16 at 989 rpm. Similarly, a DDP fan can be selected using , or .

From Figure 6, p. 39, supply fan motor heat gain = 44 MBh.

### 4. Determine total required cooling capacity

Required capacity = Total peak load + OA load + supply air fan motor heat.

Required capacity = 430 + 66.9 + 44 = 540.9 MBh (45.1 tons)

### 5. Determine unit capacity

From , unit capacity at 81.5 DB/66.1WB entering the evaporator, 17,500 supply air CFM, 95°F outdoor ambient, is 575 MBh (47.9 tons) with 475 MBh sensible.

### 6. Determine leaving air temperature

Unit sensible heat capacity corrected for supply air fan motor heat = 475 MBh - 44 MBh = 431 MBh. Supply air dry bulb temperature difference =

$$\frac{\text{Sensible Btu}}{1.085 \times \text{Supply CFM}} =$$

$$431 \text{ MBh} \div (1.085 \times 17,500 \text{ CFM}) = 22.7^\circ\text{F}$$

$$\text{Supply air dry bulb} = 81.5 \text{ DB} - 22.7 = 58.8^\circ\text{F}$$

Unit enthalpy difference =

$$\frac{\text{Total Btu}}{4.5 \times \text{Supply CFM}} =$$

$$575 \text{ MBh} \div (4.5 \times 17,500 \text{ CFM}) = 7.3 \text{ Btu/lb}$$

$$\text{Leaving enthalpy} = h(\text{ent WB}) - h(\text{diff}). \text{ From Table 15, p. 56 } h(\text{ent WB}) = 30.9 \text{ Btu/lb}$$

$$\text{Leaving enthalpy} = 30.9 \text{ Btu/lb} - 7.3 \text{ Btu/lb} = 23.6 \text{ Btu/lb}$$

$$\text{Supply air wet bulb} = 55.6$$

$$\text{Leaving air temperature} = 59.2 \text{ DB}/55.6\text{WB}$$

## Heating Capacity Selection

1. Determine air temperature entering heating module
 

Mixed air temperature =  $RADB + \% OA (OADB - RADB) = 70 + (0.10) (0 - 70) = 63^{\circ}F$

Supply air fan motor heat temperature rise =  $51,900 \text{ Btu} \div (1.085 \times 17,500 \text{ CFM}) = 2.73^{\circ}F$

Air temperature entering heating module =  $63.0 + 2.73 = 65.7^{\circ}F$
2. Determine total winter heating load
 

Total winter heating load = peak heating load + ventilation load - supply fan motor heat =  $475 + 133 - 51.9 = 556.1 \text{ MBh}$

  - a. Electric heating system
 

Unit operating on 460/60/3 power supply.

From [Table 54, p. 90](#), kW may be selected for a nominal 50 ton unit operating 460-volt power. The 170 kW heat module (580.1 MBh) will satisfy the winter heating load of 563 MBh.

Unit supply temperature at design heating conditions = mixed air temperature + air temperature rise =  $65.7^{\circ}F + 30.6^{\circ}F = 96.3^{\circ}F$ .

[Table 52, p. 90](#) shows an air temperature rise of  $30.6^{\circ}F$  for 17,500 CFM through the 170 kW heat module.
  - b. Gas heating system (natural gas)
 

From [Table 48, p. 88](#) select the high heat module (688.5 MBh output) to satisfy winter heating load of 563 MBh at unit CFM.

[Table 48, p. 88](#) also shows an air temperature rise of  $36.3^{\circ}F$  for 17,500 CFM through the heating module.

Unit supply temperature at design heating conditions = mixed air temperature + air temperature rise =  $65.7^{\circ}F + 36.3^{\circ}F = 102.0^{\circ}F$ .

**Figure 6. Fan motor**

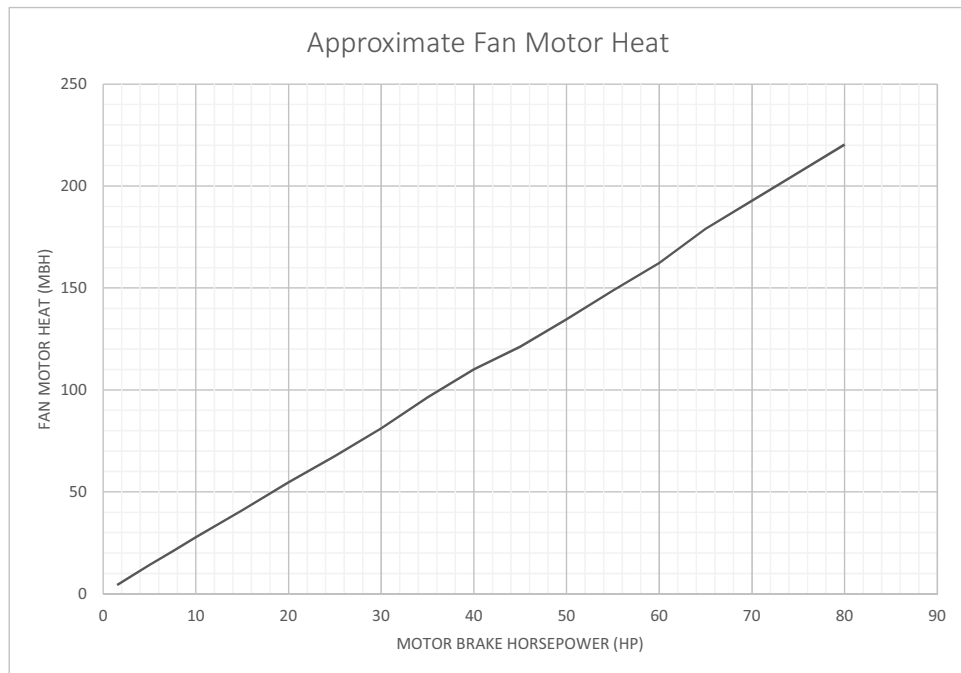

- c. Hot water heating
 

Assume a hot water supply temperature of  $190^{\circ}F$ . Subtract the mixed air temperature from the hot water temperature to determine the ITD (initial temperature difference).

ITD =  $190^{\circ}F - 65.7^{\circ}F = 126^{\circ}F$ . Divide the winter heating load by ITD =  $563 \text{ MBh} \div 126^{\circ}F = 4.50$



## Selection Procedure

Q/ITD.

From Table 55, p. 91, select the low heat module. By interpolation, a Q/ITD of 4.50 can be obtained at a gpm at 25.7.

Water pressure drop at 25.7 gpm is 0.57 ft. of water. Heat module temperature rise is determined by:

$$\frac{\text{Total Btu}}{1.085 \times \text{Supply CFM}} = \Delta T$$

$$\frac{563,000}{1.085 \times 17,500} = 29.7^{\circ}\text{F}$$

Unit supply air temperature = mixed air temperature + air temperature rise = 65.7 + 29.7 = 95°F.

### d. Steam heating system

Assume a 15 psig steam supply.

From Table 51, p. 89, the saturated temperature steam is 250°F. Subtract mixed air temperature from the steam temperature to determine ITD. ITD = 250°F - 65.7°F = 186°F.

Divide winter heating load by ITD = 563 MBh ÷ 186°F = 3.03 Q/ITD.

From Table 50, p. 89, select the high heat module. The high heat module at 17,500 CFM has a Q/ITD = 5.11.

Heat module capacity, Q = ITD x Q/ITD = 186 F x 5.11 Q/ITD = 950 MBh

Heat module air temperature rise

$$\frac{\text{Total Btu}}{1.085 \times \text{Supply CFM}} = \Delta T$$

945 Btu ÷ (1.085 x 17,500 CFM) = 50°F.

Unit supply temperature at design conditions = mixed air temperature + air temperature rise = 65.1°F + 50°F = 116°F.

## Air Delivery Procedure

Supply fan performance curves include internal resistance of rooftop. For total static pressure determination, system external static must be added to appropriate component static pressure drop (evaporator coil, filters, optional economizer, optional relief fan, optional heating system, optional cooling only extended casing, optional roof curb).

### Supply Fan Motor Sizing

The supply fan motor selected in the cooling capacity determination was 16 bhp and 989 rpm. Thus, a 20 hp supply fan motor is selected. For an FC fan selection, enter Table 59, p. 121 to select the proper drive. For a 50 ton rooftop with 20 hp motor, a drive number A - 1000 rpm is selected.

### Relief Fan Motor Sizing

The relief fan is selected based on total return system negative static pressure and relief fan CFM. Return system negative static include return duct static and roof curb static pressure drop.

Return duct static pressure = 0.65 inches

Trane® roof curb (Table 56, p. 119) = 0.12 inches

Total return system negative static pressure = 0.77 inches

Relief fan CFM = 12,000 CFM

From , the required bhp is 3.45 hp at 574 rpm. Thus, the relief fan motor selected is 5 hp.



To select a drive, enter [Table 64, p. 123](#) for a 5 hp motor for a 50 ton unit. Drive selection number 6 - 600 rpm.

Where altitudes are significantly above sea level, use , and [Table 17, p. 57](#) and [Figure 7, p. 57](#) for applicable correction factors.

## Return Fan Motor Sizing

The return fan is selected based on the return fan CFM and the total return system negative static pressure. The return system negative static includes the return duct static, the relief damper pressure drop, and any roof curb static pressure drop.

Since return fans handle all of the return static, supply fan motor sizing does not need to include this value. This feature is helpful if the supply motor HP is over the maximum limit and in some cases, can allow supply motor downsizing.

However, since the return fan runs continuously to handle all of the return static, the sensible heat generated by the motor must be included in the entering evaporator coil mixed temperature equation.

Return Duct Static Pressure = 0.65

Roof curb Static Pressure ([Table 56, p. 119](#)) = 0.12

Relief Damper Pressure Drop = 0.41

Total Return System Static Pressure = 1.18

Return Fan CFM = 12000

From , the required bhp is 4.55. Thus the return fan is selected at 5HP. To select a drive, look at table [Table 69, p. 127](#) for a 5HP return motor on a 50 HP unit. Drive selection number C - 1200.

Using [Figure 6, p. 39](#) for fan motor heat, motor heat for 4.55 BHP = 10.4 MBh

$10.4 \text{ MBh} / (1.085 \times 12000 \text{ return fan CFM}) = 0.80^\circ\text{F}$

0.80°F is added to the return air temperature

## Modulating Hot Gas Reheat Selection

The hot gas reheat coil is designed to deliver maximum reheat temperatures. Contact the local Trane Sales Office or refer to the IntelliPak™ Trane Select Assist (TSA) program to determine leaving air temperature, latent capacity, reheat sensible capacity, leaving unit dew point, and moisture removal when the unit is in reheat operation. If the reheat setpoint is not obtainable at the provided conditions the customer will be required to make adjustments to the conditions or change the reheat setpoint value. Please note that reheat operation will not be allowed when there is a call for heating or more than 50% call for cooling.

## Unit Electrical Requirements

Selection procedures for electrical requirements for wire sizing amps and maximum overcurrent protection devices sizing are given in the electrical service section of this catalog.

## Altitude Corrections

The rooftop performance tables and curves of this catalog are based on standard air (.075 lbs/ft). If the rooftop airflow requirements are at other than standard conditions (sea level), an air density correction is needed to project accurate unit performance.

[Figure 7, p. 57](#) shows the air density ratio at various temperatures and elevations. Trane® rooftops are designed to operate between 40 and 90 degrees Fahrenheit leaving air temperature. The procedure to use when selecting a supply or relief fan on a rooftop for elevations and temperatures other than standard is as follows:

1. First, determine the air density ratio using [Figure 7, p. 57](#).
2. Divide the static pressure at the nonstandard condition by the air density ratio to obtain the corrected static pressure.
3. Use the actual CFM and the corrected static pressure to determine the fan rpm and bhp from the rooftop performance tables or curves.



## Selection Procedure

---

4. The fan rpm is correct as selected.
5. Bhp must be multiplied by the air density ratio to obtain the actual operating bhp.

In order to better illustrate this procedure, the following example is used:

Consider a 60 ton rooftop unit that is to deliver 18,000 actual CFM at 3-inches total static pressure (tsp), 55°F leaving air temperature, at an elevation of 5,000 ft. From [Figure 7, p. 57](#), the air density ratio is 0.86.

The rpm is correct as selected - 906 rpm.

From the performance tables: a 60 ton rooftop will deliver 18,000 CFM at 3.49-inches tsp at 992 rpm and 26.1 bhp.

$Tsp = 3.0\text{-inches} / 0.86 = 3.49\text{ inches tsp.}$

$Bhp = 26.1 \times 0.86 = 22.4\text{ bhp actual.}$

Compressor MBh, SHR, and kW should be calculated at standard and then converted to actual using the correction factors in . Apply these factors to the capacities selected at standard CFM so as to correct for the reduced mass flow rate across the condenser. Heat selections other than gas heat will not be affected by altitude. Nominal gas capacity (output) should be multiplied by the factors given in [Table 17, p. 57](#) before calculating the heating supply air temperature.



# Model Number Description

## 20 to 75 Tons, Air Cooled

### Digit 1 — Unit Type

**S** = Self-Contained (Packaged Rooftop)

### Digit 2 — Unit Function

**A** = DX Cooling, No Heat  
**E** = DX Cooling, Electric Heat  
**F** = DX Cooling, Natural Gas Heat  
**L** = DX Cooling, Hot Water Heat  
**S** = DX Cooling, Steam Heat  
**X** = DX Cooling, No Heat, Extended Casing

### Digit 3 — System Type

**H** = Single Zone

### Digit 4 — Development Sequence

**P** = R-454B

### Digit 5, 6, 7 — Nominal Capacity

**\*20** = 20 Ton Air Cooled  
**\*25** = 25 Ton Air Cooled  
**\*30** = 30 Ton Air Cooled  
**\*40** = 40 Ton Air Cooled  
**\*50** = 50 Ton Air Cooled  
**\*55** = 55 Ton Air Cooled  
**\*60** = 60 Ton Air Cooled  
**\*70** = 70 Ton Air Cooled  
**\*75** = 75 Ton Air Cooled

### Digit 8 — Voltage Selection

**4** = 460/60/3 XL  
**5** = 575/60/3 XL  
**C** = 380/50/3 XL  
**D** = 415/50/3 XL  
**E** = 200/60/3 XL  
**F** = 230/60/3 XL

**Note:** SEH units (units with electric heat) utilizing 200V or 230V require dual power source.

### Digit 9 — Heating Capacity

**Note:** When the second digit is "F" (Gas Heat), the following applies: (M and T are available ONLY on 50 ton and above).

**H** = High Heat — 2-Stage  
**K** = Low Heat — Ultra Modulating  
**L** = Low Heat — 2-Stage  
**M** = Low Heat — Modulating  
**0** = No Heat  
**P** = High Heat — Modulating  
**T** = High Heat — Ultra Modulating

**Note:** When the second digit is "E" (Electric Heat), the following applies:

**D** = 30 kW  
**H** = 50 kW  
**L** = 70 kW  
**N** = 90 kW  
**Q** = 110 kW  
**R** = 130 kW  
**U** = 150 kW  
**V** = 170 kW  
**W** = 190 kW

**Note:** When the second digit is "L" (Hot Water) or "S" (Steam) Heat, one of the following valve size values must be in Digit 9:

**High Heat Coil**  
**1** = 0.50 inch  
**2** = 0.75 inch  
**3** = 1.00 inch  
**4** = 1.25 inches  
**5** = 1.50 inches  
**6** = 2.00 inches

**Low Heat Coil**  
**A** = 0.50 inch  
**B** = 0.75 inch  
**C** = 1.00 inch  
**D** = 1.25 inches  
**E** = 1.50 inches  
**F** = 2.00 inches

### Digit 10 — Design Sequence

\* = Current

**Note:** Sequence may be any letter A through Z, or any digit 1 through 9.

### Digit 11— Relief/Return Option

**0** = None  
**1** = Barometric  
**3** = Relief 3 HP with Statitrac  
**4** = Relief 5 HP with Statitrac  
**5** = Relief 7.5 HP with Statitrac  
**6** = Relief 10 HP with Statitrac  
**7** = Relief 15 HP with Statitrac  
**8** = Relief 20 HP with Statitrac  
**9** = Return 3 HP with Statitrac  
**M** = Return 5 HP with Statitrac  
**N** = Return 7.5 HP with Statitrac  
**P** = Return 10 HP with Statitrac  
**R** = Return 15 HP with Statitrac  
**T** = Return 20 HP with Statitrac

### Digit 12— Relief/Return Air Fan Drive

(Relief/Return Fan)  
**0** = None  
**4** = 400 RPM  
**5** = 500 RPM  
**6** = 600 RPM  
**7** = 700 RPM  
**8** = 800 RPM  
**9** = 900 RPM  
**A** = 1000 RPM  
**B** = 1100 RPM  
 (Return Fan Only)  
**C** = 1200 RPM  
**D** = 1300 RPM  
**E** = 1400 RPM  
**F** = 1500 RPM  
**G** = 1600 RPM  
**H** = 1700 RPM  
**J** = 1800 RPM  
**K** = 1900 RPM

### Digit 13 — Filter (Pre DX/Final)

**A** = Throwaway  
**B** = Cleanable Wire Mesh  
**C** = High Efficiency Throwaway  
**D** = Bag with Prefilter  
**E** = Cartridge with Prefilter  
**F** = Throwaway Filter Rack (Filter not included)  
**G** = Bag Filter Rack (Filter Not Included)  
**H** = Standard Throwaway Filter/Cartridge Final Filters  
**J** = High Efficiency Throwaway Filter/Cartridge Final Filters



## Model Number Description

### Digit 13 — Filter (Pre DX/Final) (continued)

**K** = Bag Filters with 2–inch Throwaway Prefilters/  
Cartridge Final Filters  
**L** = Cartridge Filters with 2–inch Throwaway  
Prefilters /Cartridge Final Filters  
**M** = Standard Throwaway Filter/Cartridge Final  
Filters with 2"Throwaway Prefilters  
**N** = High Efficiency Throwaway Filters/Cartridge  
Final Filters with 2"Throwaway Prefilters  
**P** = Bag Filters with Prefilters/Cartridge Final Filters  
with 2–inch Throwaway Prefilters  
**Q** = Cartridge Filters with Prefilters/Cartridge Final  
Filters with 2–inch Throwaway Prefilters  
**R** = High Efficiency Throwaway/Final filter rack (no  
filters)  
**T** = 2 inch and 1 inch Vertical Filter Rack (no filters)  
/Final Filter Rack (no filters)

### Digit 14 — Supply Air Fan HP

**1** = 3 HP FC  
**2** = 5 HP FC  
**3** = 7.5 HP FC  
**4** = 10 HP FC  
**5** = 15 HP FC  
**6** = 20 HP FC  
**7** = 25 HP FC  
**8** = 30 HP FC  
**9** = 40 HP FC  
**A** = 50 HP FC  
**B** = 3 HP DDP 80W  
**C** = 3 HP DDP 120W  
**D** = 5 HP DDP 80W  
**E** = 5 HP DDP 120W  
**F** = 7.5 HP DDP 80W  
**G** = 7.5 HP DDP 120W  
**H** = 10 HP DDP 80W (60-75T = 2 x 5 HP)  
**J** = 10 HP DDP 100 or 120W (60-75T = 2 x 5 HP)  
**K** = 15 HP DDP 80W (60-75T = 2 x 7.5 HP)  
**L** = 15 HP DDP 100 or 120W (60-75T = 2 x 7.5 HP)  
**M** = 20 HP DDP 80W (60-75T = 2 x 10 HP)  
**N** = 20 HP DDP 100 or 120W (60-75T = 2 x 10 HP)  
**P** = 25 HP DDP 80W  
**R** = 25 HP DDP 120W  
**T** = 30 HP DDP 80W (60-75T = 2 x 15 HP)  
**U** = 30 HP DDP 120W (60-75T = 2 x 15 HP)  
**V** = 40 HP DDP 80W(60-75T = 2 x 20 HP)  
**W** = 40 HP DDP 100 or 120W (60-75T = 2 x 20 HP)  
**X** = 50 HP DDP 80W (70-75T = 2 x 25 HP)  
**Y** = 50 HP DDP 100 or 120W (70–75T = 2 x 25 HP)  
**Z** = 30 HP DDP 100W (60-75T = 2 x 15 HP)

### Digit 15 — Supply Air Fan RPM

**4** = 400 RPM  
**5** = 500 RPM  
**6** = 600 RPM  
**7** = 700 RPM  
**8** = 800 RPM  
**9** = 900 RPM  
**A** = 1000 RPM  
**B** = 1100 RPM  
**C** = 1200 RPM  
**D** = 1300 RPM  
**E** = 1400 RPM  
**F** = 1500 RPM  
**G** = 1600 RPM  
**H** = 1700 RPM  
**J** = 1800 RPM  
**K** = 1900 RPM  
**L** = 2000 RPM  
**M** = 2100 RPM  
**N** = 2200 RPM  
**P** = 2300 RPM  
**R** = 2400 RPM

### Digit 16 — Outside Air

**A** = No Fresh Air  
**B** = 0-25% Manual  
**D** = 0-100% Economizer  
**E** = 0-100% Economizer with Traq/DCV  
**F** = 0-100% Economizer with DCV

**Note:** *Must install CO<sub>2</sub> sensor(s) for DCV to  
function properly.*

### Digit 17 — System Control

**6** = VAV Discharge Temp Control with VFD without  
Bypass  
**7** = VAV Discharge Temp Control with VFD and  
Bypass  
**8** = VAV Discharge Temp Control Supply and  
Relief/Return Fan with VFD without Bypass  
**9** = VAV Discharge Temp Control Supply and  
Relief/Return Fan with VFD and Bypass  
**A** = VAV - Single Zone VAV - with VFD without  
Bypass  
**B** = VAV - Single Zone VAV - with VFD and Bypass  
**C** = VAV - Single Zone VAV - Supply and Relief/  
Return Fan with VFD without Bypass  
**D** = VAV - Single Zone VAV - Supply and Relief/  
Return Fan with VFD with Bypass

### Digit 18 — Zone Sensor

**0** = None  
**A** = Dual Setpoint Manual or Auto Changeover  
(BAYSENS108\*)  
**C** = Room Sensor w/ Override/Cancel Buttons  
(BAYSENS073\*)  
**D** = Room Sensor w/ Temp Adjustment/Override/  
Cancel Buttons (BAYSENS074\*)  
**L** = Programmable Zone Sensor w/ System  
Function Modes for SZVAV/VAV (BAYSENS800\*)

**Note:** *\*Asterisk indicates current model number  
digit. These sensors can be ordered to ship  
with the unit.*

### Digit 19 — Ambient Control

**0** = Standard  
**1** = 0° Fahrenheit

### Digit 20 — Agency Approval

**0** = None (cULus Gas Heater, see note)  
**1** = cULus

**Note:** *Includes cULus classified gas heating  
section only when second digit is a "F."*

### Digit 21 — Miscellaneous Options

**0** = Unit Mounted Terminal Block  
**A** = Unit Mounted Disconnect Switch  
**B** = Unit Mounted Disconnect Switch with High  
Fault SCCR  
**D** = Unit Mounted Disconnect Switch with  
Convenience Outlet  
**E** = Unit Mounted Disconnect Switch with High  
Fault SCCR and Convenience Outlet

### Digit 22 — Refrigeration Options

**0** = Without Hot Gas Bypass  
**B** = Hot Gas Bypass  
**C** = Hot Gas Reheat without Hot Gas Bypass  
**D** = Hot Gas Reheat and Hot Gas Bypass

**Digit 23 — Economizer Control Options**

**0** = Without Economizer  
**C** = Economizer Control with Comparative Enthalpy  
**D** = Economizer with Differential Dry Bulb  
**Z** = Economizer Control with Reference Enthalpy  
**W** = Economizer Control with Dry Bulb

**Digit 24 — Damper Options**

**0** = Standard Damper or No damper  
**E** = Low Leak Economizer Dampers  
**U** = Ultra Low Leak Economizer Dampers and Ultra Low Leak motorized relief dampers when relief/return option includes motorized dampers

**Digit 25 — Power Meter**

**0** = None  
**P** = Power Meter

**Digit 26 — Efficiency Options**

**0** = Standard Efficiency Unit  
**H** = High Efficiency Unit  
**V** = eFlex™ Variable Speed Compressor

**Digit 27 — Condenser Options**

**0** = Standard Aluminum Condenser Coil  
**J** = Corrosion Protected Condenser Coil

**Digit 28 — Rapid Restart**

**0** = Standard Restart  
**R** = Rapid Restart

**Digit 29 — Miscellaneous Options**

**0** = Motors without Internal Shaft Grounding  
**A** = Motors with Internal Shaft Grounding

**Digit 30 — Expansion Module**

**0** = None  
**E** = Expansion Module

**Digit 31 — Miscellaneous Options**

**N** = Ventilation Override Module

**Digit 32 — Service Options**

**0** = None  
**R** = Extended Grease Lines  
**3** = Stainless Steel Sloped Drain Pan  
**4** = Stainless Steel Sloped Drain Pan with Grease Lines

**Digit 33 — Cabinet Options**

**0** = Standard Panels  
**1** = Standard Panels with Double Wall  
**T** = Hinged Access Doors  
**2** = Hinged Access Doors with Double Wall  
**U** = IRU - with Standard Panels  
**3** = IRU - with Standard Panels with Double Wall  
**W** = IRU - with Hinged Access Doors  
**4** = IRU - with Hinged Access Doors with Double Wall  
**Y** = IRU with SST - with Standard Panels  
**5** = IRU with SST - with Standard Panels with Double Wall  
**Z** = IRU with SST - with Hinged Access Doors  
**6** = IRU with SST - with Hinged Access Doors with Double Wall

**Digit 34 — Filter Monitor**

**0** = None  
**1** = Pre-Evaporator  
**2** = Pre-Evaporator and Final Filter

**Digit 35 — BAS/Communication Options**

**0** = None  
**7** = Trane LonTalk Communication Interface Module  
**8** = Modbus®  
**M** = BACNet® Communications Interface  
**W** = Air-Fi® Wireless

**Digit 36 — Isolators**

**8** = Spring Isolators

**Digit 37 — Airflow**

**A** = Downflow Supply/Upflow Return  
**B** = Horizontal Right Supply/ Horizontal End Return  
**C** = Horizontal Right Supply/Upflow Return  
**E** = Downflow Supply/Horizontal End Return

**Digit 38 — Miscellaneous Options**

**A** = Supply Fan Piezometer  
**B** = Supply Isolation damper  
**C** = Return Isolation damper  
**D** = Both Supply and Return Isolation damper  
**E** = Piezometer with Supply Isolation damper  
**F** = Piezometer with Return Isolation damper  
**G** = Piezometer with both Supply and Return Isolation damper



## Model Number Description

# 90 to 130 Tons, Air Cooled

### Digit 1 — Unit Type

**S** = Self-Contained (Packaged Rooftop)

### Digit 2 — Unit Function

**E** = DX Cooling, Electric Heat  
**F** = DX Cooling, Natural Gas Heat  
**L** = DX Cooling, Hot Water Heat  
**S** = DX Cooling, Steam Heat  
**X** = DX Cooling, No Heat, Extended Casing

### Digit 3 — System Type

**H** = Single Zone

### Digit 4 — Development Sequence

**R** = R-454B Development Sequence

### Digit 5, 6, 7 — Nominal Capacity

\***90** = 90 Ton Air Cooled  
\***11** = 105 Ton Air Cooled  
\***12** = 115 Ton Air Cooled  
\***13** = 130 Ton Air Cooled

### Digit 8 — Power Supply

**4** = 460/60/3 XL  
**5** = 575/60/3 XL

### Digit 9 — Heating Capacity

**Note:** When Digit 2 is "F" (Gas Heat), the following values apply in Digit 9:

**H** = High Heat – 2-stage  
**O** = No Heat  
**P** = High Heat — Modulation  
**T** = High Heat—Ultra Modulation

**Note:** When the second digit calls for "E" (electric heat), the following values apply in Digit 9:

**W** = 190 kW

**Note:** When the second digit calls for "L" (hot water) or "S" (steam) heat, one of the following valve size values must be in Digit 9:

**High Heat Coil:** 3 = 1", 4 = 1.25", 5 = 1.5", 6 = 2", 7 = 2.5"

**Low Heat Coil:** C = 1", D = 1.25", E = 1.5", F = 2", G = 2.5"

### Digit 10 — Design Sequence

\* = Current

**Note:** Sequence may be any letter A through Z, or any digit 1 through 9.

### Digit 11 — Relief Option

**0** = None  
**7** = 100% Relief 15 HP with Statitrac  
**8** = 100% Relief 20 HP with Statitrac  
**9** = 100% Relief 25 HP with Statitrac  
**H** = 100% Relief 30 HP with Statitrac  
**J** = 100% Relief 40 HP with Statitrac

### Digit 12 — Relief Fan

(Relief Fan)

**0** = None  
**5** = 500 RPM  
**6** = 600 RPM  
**7** = 700 RPM  
**8** = 800 RPM

### Digit 13 — Filter (Pre DX/Final)

**A** = Throwaway  
**C** = High Efficiency Throwaway  
**D** = Bag with Prefilter  
**E** = Cartridge with Prefilter  
**F** = Throwaway Filter Rack (filter not included)  
**G** = Bag Filter Rack (Filter Not Included)  
**H** = Standard Throwaway Filter/Cartridge Final Filters  
**J** = High Efficiency Throwaway Filter/Cartridge Final Filters  
**K** = Bag Filters with 2" Throwaway Prefilters/Cartridge Final Filters  
**L** = Cartridge Filters with 2" Throwaway Prefilters/Cartridge Final Filters  
**M** = Standard Throwaway Filter/Cartridge Final Filters with 2-inch Throwaway Prefilters  
**N** = High Efficiency Throwaway Filters/Cartridge Final Filters with 2-inch Throwaway Prefilters  
**P** = Bag Filters with Prefilters Cartridge Final Filters with 2-inch Throwaway Prefilters  
**Q** = Cartridge Filters with Prefilters/Cartridge Final Filters with 2-inch Throwaway Prefilters

### Digit 14 — Supply Air Fan HP

**C** = 30 HP (2x15 HP)  
**D** = 40 HP (2x20 HP)  
**E** = 50 HP (2x25 HP)  
**F** = 60 HP (2x30 HP)  
**G** = 80 HP (2x40 HP)

### Digit 15 — Supply Air Fan Drive

**A** = 1000 RPM  
**B** = 1100 RPM  
**C** = 1200 RPM  
**D** = 1300 RPM  
**E** = 1400 RPM  
**F** = 1500 RPM  
**G** = 1600 RPM

### Digit 16 — Outside Air

**D** = 0-100% Economizer (Std.)  
**E** = 0-100% Economizer with Traq with DCV  
**F** = 0-100% Economizer with DCV

**Note:** Must install CO<sub>2</sub> sensor(s) for DCV to function properly.

### Digit 17 — System Control

**6** = VAV Discharge Temperature Control with VFD without Bypass  
**7** = VAV Discharge Temperature Control with VFD and Bypass  
**8** = VAV Discharge Temperature Control Supply and Relief Fan with VFD without Bypass  
**9** = VAV Discharge Temperature Control Supply and Relief Fan with VFD and Bypass  
**A** = VAV – Single Zone VAV – with VFD without Bypass  
**B** = VAV – Single Zone VAV – with VFD with Bypass  
**C** = VAV – Single Zone VAV – Supply and Relief/Return Fan with VFD without Bypass  
**D** = VAV – Single Zone VAV – Supply and Relief/Return Fan with VFD with Bypass

### Digit 18 — Zone Sensor

**0** = None  
**A** = Dual Setpoint Manual or Auto Changeover (BAYSENS108\*)  
**C** = Room Sensor with Override and Cancel Buttons (BAYSENS073\*)  
**D** = Room Sensor with Temperature Adjustment and Override and Cancel Buttons (BAYSENS074\*)  
**L** = Programmable Zone Sensor with System Function Modes for VAV (BAYSENS800\*)

**Note:** \*Asterisk indicates current model number digit A, B, C, etc. These sensors can be ordered to ship with the unit.

### Digit 19 — Ambient Control

0 = Standard  
1 = 0° Fahrenheit

### Digit 20 — Agency Approval

0 = None (cULus Gas Heater, see note)  
1 = cULus

*Note: Includes cULus classified gas heating section only when second digit of Model No. is a "F."*

### Digit 21 — Miscellaneous

0 = Unit Mounted Terminal Block  
A = Unit Mounted Disconnect Switch  
B = Unit Mounted Disconnect Switch with High Fault SCCR  
D = Unit Mounted Disconnect Switch with Convenience Outlet  
E = Unit Mounted Disconnect Switch with High Fault SCCR and Convenience Outlet

### Digit 22 — Refrigeration Options

0 = Without Hot Gas Bypass  
B = Hot Gas Bypass

### Digit 23 — Economizer Control Options

C = Economizer Control with Comparative Enthalpy  
D = Economizer with Differential Dry Bulb  
Z = Economizer Control with Reference Enthalpy  
W = Economizer Control with Dry Bulb

### Digit 24 — Damper Options

0 = Standard Dampers  
E = Low Leak Economizer Dampers  
U = Ultra Low Leak Economizer Dampers and Ultra Low Leak motorized relief dampers

### Digit 25 — Power Meter

0 = None  
1 = Power Meter

### Digit 26 — Efficiency Options

0 = Standard Efficiency Unit  
H = High Efficiency Unit

### Digit 27 — Condenser Coil Options

0 = Air Cooled Aluminum Condenser Coil  
J = Corrosion-Protected Condenser Coil

### Digit 28 — Rapid Restart

0 = Non-Rapid Restart  
R = Rapid Restart

### Digit 29 — Miscellaneous

0 = Motors without Internal Shaft Grounding  
A = Motors with Internal Shaft Grounding

### Digit 30 — Expansion Module

0 = None  
E = Expansion Module

### Digit 31 — Miscellaneous

N = Ventilation Override Module

### Digit 32 — Service Options

0 = None  
R = Extended Grease Lines  
3 = Stainless Steel Sloped Drain Pan  
4 = Stainless Steel Sloped Drain Pan with Grease Lines

### Digit 33 — Cabinet Options

0 = Standard Panels  
1 = Standard Panels with Double Wall  
T = Hinged Access Doors  
2 = Hinged Access Doors with Double Wall  
U = IRU - with Standard Panels  
3 = IRU - with Standard Panels with Double Wall  
W = IRU - with Hinged Access Doors  
4 = IRU - with Hinged Access Doors with Double Wall  
Y = IRU with SST - with Standard Panels  
5 = IRU with SST - with Standard Panels with Double Wall  
Z = IRU with SST - with Hinged Access Doors  
6 = IRU with SST - with Hinged Access Doors with Double Wall

### Digit 34 — Filter Monitor

0 = None  
1 = Pre-Evaporator  
2 = Pre-Evaporator and Final Filter

### Digit 35 — BAS/Communication Options

0 = None  
7 = Trane LonTalk Communication Interface Module  
8 = ModBus®  
M = BACnet® Communication Interface Module  
W = Air-Fi® Wireless

### Digit 36 — Isolators

8 = Spring Isolators

### Digit 37 — Airflow

A = Downflow Supply/Upflow Return  
B = Horizontal Right Supply/ Horizontal End Return  
C = Horizontal Right Supply/Upflow Return  
E = Downflow Supply/Horizontal End Return



# General Data

**Table 9. General data - 20 to 50 tons**

	20 Ton	25 Ton	30 ton	40 Ton	50 Ton
<b>Compressor Data - Standard Efficiency<sup>(a)</sup></b>					
Number/Size (Nominal)	1/12.8,1/8.7	1/15.9,2/9.5	1/15.9,2/10.9	2/8.7,2/9.5	2/9.8,2/11.3
Model	Scroll	Scroll	Scroll	Scroll	Scroll
Unit Capacity Steps (%)	100/82/40/23	100/76/62/38/24	100/79/61/39/21	100/74/48/24	100/73/46/23
No. of Circuits	1	1	1	2	2
<b>Compressor Data - High Efficiency<sup>(a)</sup></b>					
Number/Size (Nominal)	1/12.8,1/8.7	1/15.2,1/10.2	1/15.9,2/9.8	2/7.4,2/8.7	1/9.8,3/11.3
Model	Scroll	Scroll	Scroll	Scroll	Scroll
Unit Capacity Steps (%)	100/82/40/23	100/82/60/40/22	100/77/62/38/23	100/73/46/23	100/74/48/22
No. of Circuits	1	1	1	2	2
<b>Compressor Data - eFlex Variable Speed<sup>(a)</sup></b>					
Number/Size (Nominal)	1/3-13 VS,1/9.5	1/3-13 VS,1/11.3	1/4-17 VS,1/12.8	1/4-17 VS,2/9.5	1/6-25 VS,2/11.3
Capacity Control	Modulating	Modulating	Modulating	Modulating	Modulating
Unit Capacity Steps (%)	15-100	15-100	15-100	15-100	15-100
Number of Circuits	1	1	1	2	2
<b>Air-Cooled Condenser Fans</b>					
Number/Size/Type	2/30"/Prop	2/30"/Prop	2/30"/Prop	4/30"/Prop	4/30"/Prop
Hp (each)	1.5	1.5	1.5	1.5	1.5
Cycle/Phase	60/3	60/3	60/3	60/3	60/3
<b>Evaporator Fans - Forward-Curved Fans (FC)</b>					
Number/Size	2/15"	2/15"	2/18"	2/20"	2/20"
Number of Motors	1	1	1	1	1
Hp Range	3-20	3-20	5-20	7.5-30	7.5-30
Cfm Range <sup>(b)</sup>	4,000-9,000	5,000-11,000	6,000-13,500	8,000-18,000	10,000-22,500
ESP Range - (In. WG)	0.25-4.0	0.25-4.0	0.25-4.0	0.25-4.0	0.25-4.0
<b>Evaporator Fans - eDrive™ Direct Drive Plenum Fans (DDP)</b>					
Number/Size <sup>(c)</sup>	1/22.2"	1/22.2"	1/24.5"	1/27.0"	1/30.0"
Number of Motors	1	1	1	1	1
Hp Range	3-20	3-20	3-20	3-25	5-30
Cfm Range <sup>(b)</sup>	4,000-9,000	5,000-11,000	6,000-13,500	8,000-18,000	10,000-22,500
ESP Range - (In. WG)	0.25-4.0	0.25-4.0	0.25-4.0	0.25-4.0	0.25-4.0
<b>Relief Fans - Forward-Curved Fans (FC) 100% Airflow</b>					
Number/Size/Type	2/15"	2/15"	2/15"	2/18"	2/18"
Hp Range	3	3-5	3-7.5	5-10	5-10
Cfm Range <sup>(b)</sup>	4,000-10,000	4,000-12,000	4,000-14,000	7,500-16,000	9,000-20,000
ESP Range - (In. WG)	0.2-2.0	0.2-2.0	0.2-2.0	0.2-2.0	0.2-2.0
<b>Return Fans - Belt Drive Plenum Fans (AF)</b>					
Number/Size	1/24.5	1/24.5	1/24.5	1/27.0	1/27.0
Hp Range	3	3.0 - 5.0 HP	3.0 - 7.5	5.0 - 10.0	5.0 - 15.0
Cfm Range	4,000-9,000	4,000-11,000	4,000-12,500	7,500-18,000	9,000-20,000
ESP Range - (In. WG)	0.25 - 2.0	0.25 - 2.0	0.25 - 2.0	0.25 - 2.0	0.25 - 2.0



**Table 9. General data - 20 to 50 tons (continued)**

	20 Ton	25 Ton	30 ton	40 Ton	50 Ton
<b>Compressor Data - Standard Efficiency<sup>(a)</sup></b>					
<b>Evaporator Coil</b>					
Size (Ft <sup>2</sup> )	20.3	20.3	25.5	32.5	38
Rows/Fin Series	4/168	4/168	5/168	5/168	4/168
Tube Diameter/Surface	1/2"/Enhanced	1/2"/Enhanced	3/8"/Enhanced	3/8"/Enhanced	1/2"/Enhanced
<b>Air-Cooled Condenser Coil</b>					
Face Area (Ft <sup>2</sup> )	58	58	58	116	116
Fin Series	252	252	252	252	252
Type	Microchannel	Microchannel	Microchannel	Microchannel	Microchannel
<b>Electric Heat</b>					
kW Range <sup>(d)</sup>	30-110	30-130	30-150	50-170	70-190
Capacity Steps	3	3	3	3	3
<b>Natural Gas Heat<sup>(c)</sup></b>					
Low Heat Input <sup>(e)</sup>	235	235	350	350	500
High Heat Input <sup>(f)</sup>	500	500	500	850	850
Staged Heating Capacity Steps <sup>(g)</sup>	2	2	2	2	2
Modulating Gas Heat Turn Down	See Table 14	See Table 14	See Table 14	See Table 14	See Table 14
Steady State Efficiency % <sup>(h)</sup>	81%	81%	81%	81%	81%
<b>Hot Water Coil</b>					
Size (Inches)	30x66x2 Row	30x66x2 Row	30x66x2 Row	42x66x2 Row	42x66x2 Row
Type	5W Prima-Flo E w/ turbulators	5W Prima-Flo E w/ turbulators	5W Prima-Flo E w/ turbulators	5W Prima-Flo E w/ turbulators	5W Prima-Flo E w/ turbulators
High Heat (Fins/Ft)	110	110	110	110	110
Low Heat (Fins/Ft)	80	80	80	80	80
<b>Steam Coil</b>					
Size (Inches)	30x66x1 Row	30x66x1 Row	30x66x1 Row	30x66x1 Row, 12x66x1 Row	30x66x1 Row 12x66x1 Row
Type	Type NS	Type NS	Type NS	Type NS	Type NS
High Heat (Fins/Ft)	96	96	96	96	72
Low Heat (Fins/Ft)	42	42	42	42	42
<b>Pre-Evap Filters</b>					
Panel Filters (Number/Size - Inches)	12 - 20x20x2	12 - 20x20x2	16 - 20x20x2	16 - 20x25x2	20 - 20x25x2
Face Area (Ft <sup>2</sup> )	33.3	33.3	44.4	55.5	69.4
Bag Filters (Number/Size - Inches)	4 - 12x24x19	4 - 12x24x19	2 - 12x24x19	5 - 12x24x19	3 - 12x24x19
	3 - 24x24x19	3 - 24x24x19	6 - 24x24x19	6 - 24x24x19	9 - 24x24x19
Cartridge Filters (Number/Size - Inches)	4 - 12x24x12	4 - 12x24x12	2 - 12x24x12	5 - 12x24x12	3 - 12x24x12
	3 - 24x24x12	3 - 24x24x12	6 - 24x24x12	6 - 24x24x12	9 - 24x24x12
Prefilters (For Bag & Cartridge) (Number/Size - Inches)	4 - 12x24x2	4 - 12x24x2	2 - 12x24x2	5 - 12x24x2	3 - 12x24x2
	3 - 24x24x2	3 - 24x24x2	6 - 24x24x2	6 - 24x24x2	9 - 24x24x2
Face Area (Ft <sup>2</sup> )	20	20	28	34	42
<b>Final Filters (SX Units only)</b>					
Cartridge Filters (Number/Size - Inches)	4 - 12x24x12	4 - 12x24x12	1 - 12x24x12	5 - 12x24x12	2 - 12x24x12
	3 - 24x24x12	3 - 24x24x12	6 - 24x24x12	6 - 24x24x12	9 - 24x24x12



## General Data

**Table 9. General data - 20 to 50 tons (continued)**

	20 Ton	25 Ton	30 ton	40 Ton	50 Ton
<b>Compressor Data - Standard Efficiency<sup>(a)</sup></b>					
Prefilters (For Cartridge Filters) (Number/Size - Inches)	4 - 12x24x2	4 - 12x24x2	1 - 12x24x2	5 - 12x24x2	2 - 12x24x2
	3 - 24x24x2	3 - 24x24x2	6 - 24x24x2	6 - 24x24x2	9 - 24x24x2
Face Area (Ft <sup>2</sup> )	20	20	26	34	40
<b>Standard Unit Minimum Outside Air Temperature for Mechanical Cooling<sup>(i)</sup></b>					
Without Hot Gas Option	55°F	50°F	50°F	55°F	45°F
With Hot Gas Option	55°F	50°F	50°F	55°F	45°F
<b>Low Ambient Option Minimum Outside Air Temperature</b>					
Without Hot Gas Option	0°F	0°F	0°F	0°F	0°F
With Hot Gas Option	10°F	10°F	10°F	10°F	10°F

(a) 20 to 30 ton models are single circuit, 40 ton and above models are dual circuit.

(b) For CFM values outside these ranges, contact your local Trane sales office.

(c) 20-25T units with gas heat require 24.5" DDP fan; 30T units with gas heat require 27" DDP fan; and 40T units with gas heat require 30" fan.

(d) Refer to Electric heat kW ranges table for availability of kW ranges by voltage.

(e) Modulating is not available on 20 to 40T low heat.

(f) 40 and 50T High Heat with Horizontal Discharge is 800MBH. MBH is listed on gas heat rating plate.

(g) Two-stage gas heat: 1st stage 50% of heater MBh.

(h) Heating Performance is AHRI and DOE certified.

(i) Maximum return temperatures of 95°F. Any higher, contact Product Support.

**Table 10. General data - 55 to 75 tons**

	55 ton	60 Ton	70 ton	75 ton
<b>Compressor Data - Standard Efficiency<sup>(a)</sup></b>				
Number/Size (Nominal)	1/11.3,3/12.8	3/12.8,1/14.9	2/14.9,1/15,1/20.5	2/15,2/20.5
Model	Scroll	Scroll	Scroll	Scroll
Unit Capacity Steps (%)	100/74/48/23	100/72/48/24	100/69/46/23	100/71/42/21
No. of Circuits	2	2	2	2
<b>Compressor Data - High Efficiency<sup>(a)</sup></b>				
Number/Size (Nominal)	3/11.3,1/12.8	2/12.8,2/14.9	4/14.9	1/15,3/20.5
Model	Scroll	Scroll	Scroll	Scroll
Unit Capacity Steps (%)	100/73/48/24	100/73/46/23	100/75/50/25	100/73/46/20
No. of Circuits	2	2	2	2
<b>Compressor Data - eFlex Variable Speed<sup>(a)</sup></b>				
Number/Size (Nominal)	1/6-25 VS,2/12.8	1/6-25 VS,1/12.8,2/14.9	1/6-25 VS,2/19.5	1/6-25 VS,1/15,2/14.9
Capacity Control	Modulating	Modulating	Modulating	Modulating
Unit Capacity Steps (%)	15-100	15-100	15-100	15-100
Number of Circuits	2	2	2	2
<b>Air-Cooled Condenser Fans</b>				
Number/Size/Type	4/30"/Prop	6/26"/Prop	6/26"/Prop	6/26"/Prop
Hp (each)	1.5	1	1	1
Cycle/Phase	60/3	60/3	60/3	60/3
<b>Evaporator Fans - Forward-Curved Fans (FC)</b>				
Number/Size	2/20"	2/22"	2/22"	2/22"
Number of Motors	1	1	1	1
Hp Range	7.5-30	10-50	10-50	10-50
Cfm Range <sup>(b)</sup>	10,000-22,500	14,000-27,000	16,000-27,000	16,000-27,000
ESP Range - (In. WG)	0.25-4.0	0.25-4.0	0.25-4.0	0.25-4.0
<b>Evaporator Fans - eDrive™ Direct Drive Plenum Fans (DDP)</b>				
Number/Size	1/30.0"	2/24.5"	2/27.0"	2/27.0"

**Table 10. General data - 55 to 75 tons (continued)**

Number of Motors	1	2	2	2
Hp Range	5-30	10-40	10-50	10-50
Cfm Range <sup>(b)</sup>	10,000-22,500	14,000-27,000	16,000-27,000	16,000-27,000
ESP Range - (In. WG)	0.25-4.0	0.25-4.0	0.25-4.0	0.25-4.0
<b>Relief Fans - Forward-Curved Fans (FC)</b>				
<b>100% Airflow</b>				
Number/Size/Type	2/18"	2/20"	2/20"	2/20"
Hp Range	5-15	5-20	5-20	5-20
Cfm Range <sup>(b)</sup>	9,000-20,000	12,000-27,000	12,000-27,000	12,000-27,000
ESP Range - (In. WG)	0.2-2.0	0.2-2.0	0.2-2.0	0.2-2.0
<b>Return Fans - Belt Drive Plenum Fans (AF)</b>				
Number/Size	1/27.0	1/36.5	1/36.5	1/36.5
Hp Range	5.0 - 15.0	5.0 - 20.0	5.0 - 20.0	5.0 - 20.0
Cfm Range	9,000-20,000	12,000-27,000	12,000-27,000	12,000-27,000
ESP Range - (In. WG)	0.25 - 2.0	0.25 - 2.0	0.25 - 2.0	0.25 - 2.0
<b>Evaporator Coil</b>				
Size (Ft <sup>2</sup> )	38	43	43	43
Rows/Fin Series	4/168	6/168	6/168	6/168
Tube Diameter/Surface	1/2"/Enhanced	3/8"/Enhanced	3/8"/Enhanced	3/8"/Enhanced
<b>Air-Cooled Condenser Coil</b>				
Face Area (Ft <sup>2</sup> )	116	136	136	136
Fin Series	252	252	252	252
Type	Microchannel	Microchannel	Microchannel	Microchannel
<b>Electric Heat</b>				
kW Range <sup>(c)</sup>	70-190	90-190	90-190	90-190
Capacity Steps	3	3	3	3
<b>Natural Gas Heat</b>				
Low Heat Input	500	500	500	500
High Heat Input <sup>(d)</sup>	850	850	850	850
Staged Heating Capacity Steps <sup>(e)</sup>	2	2	2	2
Modulating Gas Heat Turn Down	See Table 14	See Table 14	See Table 14	See Table 14
Steady State Efficiency % <sup>(f)</sup>	81%	81%	81%	81%
<b>Hot Water Coil</b>				
Size (Inches)	42x66x2 Row	42x90x2 Row	42x90x2 Row	42x90x2 Row
Type	5W Prima-Flo E w/ turbulators	5W Prima-Flo E w/ turbulators	5W Prima-Flo E w/ turbulators	5W Prima-Flo E w/ turbulators
High Heat (Fins/Ft)	110	110	110	110
Low Heat (Fins/Ft)	80	80	80	80
<b>Steam Coil</b>				
Size (Inches)	30x66x1 Row 12x66x1 Row	30x90x1 Row 12x90x1 Row	30x90x1 Row 12x90x1 Row	30x90x1 Row 12x90x1 Row
Type	Type NS	Type NS	Type NS	Type NS
High Heat (Fins/Ft)	96	72	72	72
Low Heat (Fins/Ft)	42	42	42	42
<b>Pre-Evap Filters</b>				
Panel Filters (Number/Size - Inches)	20 - 20x25x2	35 - 16x20x2	35 - 16x20x2	35 - 16x20x2
Face Area (Ft <sup>2</sup> )	69.4	77.8	77.8	77.8
Bag Filters (Number/Size - Inches)	3 - 12x24x19	6 - 12x24x19	6 - 12x24x19	6 - 12x24x19
	9 - 24x24x19	8 - 24x24x19	8 - 24x24x19	8 - 24x24x19



**General Data**

**Table 10. General data - 55 to 75 tons (continued)**

Cartridge Filters (Number/Size - Inches)	3 - 12x24x12	6 - 12x24x12	6 - 12x24x12	6 - 12x24x12
	9 - 24x24x12	8 - 24x24x12	8 - 24x24x12	8 - 24x24x12
Prefilters (For Bag & Cartridge) (Number/Size - Inches)	3 - 12x24x2	6 - 12x24x2	6 - 12x24x2	6 - 12x24x2
	9 - 24x24x2	8 - 24x24x2	8 - 24x24x2	8 - 24x24x2
Face Area (Ft <sup>2</sup> )	42	44	44	44
<b>Final Filters (SX Units only)</b>				
Cartridge Filters (Number/Size - Inches)	2 - 12x24x12	6 - 12x24x12	6 - 12x24x12	6 - 12x24x12
	9 - 24x24x12	8 - 24x24x12	8 - 24x24x12	8 - 24x24x12
Prefilters (For Cartridge Filters) (Number/Size - Inches)	2 - 12x24x2	6 - 12x24x2	6 - 12x24x2	6 - 12x24x2
	9 - 24x24x2	8 - 24x24x2	8 - 24x24x2	8 - 24x24x2
Face Area (Ft <sup>2</sup> )	40	44	44	44
<b>Standard Unit Minimum Outside Air Temperature for Mechanical Cooling<sup>(g)</sup></b>				
Without Hot Gas Option	35°F	30°F	45°F	45°F
With Hot Gas Option	35°F	30°F	45°F	45°F
<b>Low Ambient Option Minimum Outside Air Temperature</b>				
Without Hot Gas Option	0°F	0°F	0°F	0°F
With Hot Gas Option	10°F	10°F	10°F	10°F

- (a) 20 to 30 ton models are single circuit, 40 ton and above models are dual circuit.
- (b) For CFM values outside these ranges, contact your local Trane sales office.
- (c) Refer to Electric heat kW ranges table for availability of kW ranges by voltage.
- (d) Horizontal Discharge is 800MBH. MBH is listed on gas heat rating plate.
- (e) Two-stage gas heat: 1st stage 50% of heater MBh.
- (f) Heating Performance is AHRI and DOE certified.
- (g) Maximum return temperatures of 95°F. Any higher, contact Product Support.

**Table 11. General data - 90 to 130 tons**

	90 ton	105 ton	115 ton	130 ton
<b>Compressor Data - Standard Efficiency<sup>(a)</sup></b>				
Number/Size (Nominal)	4/20.5	2/20.5,2/25.5	1/20.5,3/25.5	2/25.5,2/29.7
Model	Scroll	Scroll	Scroll	Scroll
Unit Capacity Steps (%)	100/75/50/25	100/72/45/22	100/74/47/21	100/73/46/23
No. of Circuits	2	2	2	2
<b>Compressor Data - High Efficiency<sup>(a)</sup></b>				
Number/Size (Nominal)	4/20.5	NA	NA	NA
Model	Scroll	NA	NA	NA
Unit Capacity Steps (%)	100/75/50/25	NA	NA	NA
No. of Circuits	2	NA	NA	NA
<b>Evaporator Fans - Airfoil</b>				
Number/Size	2/28"	2/28"	2/28"	2/28"
Number of Motors	2	2	2	2
Hp Range	30-80	30-80	30-80	30-80
Cfm Range <sup>(b)</sup>	26,000-46,000	26,000-46,000	26,000-46,000	26,000-46,000
ESP Range - (In. WG)	1.0-4.70	1.0-4.70	1.0-4.70	1.0-4.70
<b>Relief Fans - Forward-Curved Fans (FC) 100% Airflow</b>				
Number/Size/Type	2/22"	2/22"	2/22"	2/22"
Hp Range	15-40	15-40	15-40	15-40
Cfm Range <sup>(b)</sup>	26,000-40,000	26,000-40,000	26,000-40,000	26,000-40,000
ESP Range - (In. WG)	0.25-2.5	0.25-2.5	0.25-2.5	0.25-2.5
<b>Condenser Fans - Prop. Condenser Fans - Standard Efficiency</b>				
Number/Size	8/26"	10/26"	10/26"	12/26"

**Table 11. General data - 90 to 130 tons (continued)**

Hp (each)	1	1	1	1
Cfm Range	56400	56400	56400	56400
Cycle/Phase	60/3	60/3	60/3	60/3
<b>Condenser Fans - Prop. Condenser Fans - High Efficiency</b>				
Number/Size	10/26"			
Hp (each)	1			
Cfm Range	56400			
Cycle/Phase	60/3			
<b>Coils - Evaporator Coil - Standard Efficiency</b>				
Dimensions	122.0 x 70.0	122.0 x 70.0	122.0 x 70.0	122.0 x 70.0
Size (Ft <sup>2</sup> )	59.3	59.3	59.3	59.3
Rows/Fin Series	4/148	5/148	6/148	6/148
Tube Diameter/Surface	1/2 Enhanced	1/2 Enhanced	1/2 Enhanced	1/2 Enhanced
<b>Evaporator Coil - High Efficiency</b>				
Dimensions	122.0 x 70.0	N/A	N/A	N/A
Size (Ft <sup>2</sup> )	59.3	N/A	N/A	N/A
Rows/Fin Series	6/148	N/A	N/A	N/A
Tube Diameter/Surface	1/2 Enhanced	N/A	N/A	N/A
<b>Condenser Coil - Standard Efficiency</b>				
Size (Ft <sup>2</sup> )	152	152	152	152
Rows/Fin Series	44250	44250	44250	44250
Type	Microchannel	Microchannel	Microchannel	Microchannel
<b>Condenser Coil - High Efficiency</b>				
Size (Ft <sup>2</sup> )	152	N/A	N/A	N/A
Rows/Fin Series	44250	N/A	N/A	N/A
Type	Microchannel	N/A	N/A	N/A
<b>Electric Heat</b>				
kW Range <sup>(c)</sup>	190	190	190	190
Capacity Steps	3	3	3	3
<b>Natural Gas Heat</b>				
MBh Heat Input	1000	1000	1000	1000
Staged Heating Capacity Steps <sup>(d)</sup>	2	2	2	2
High Heat	See Table 14			
Gas Heat Steady State Efficiency% <sup>(e)</sup>	81%	81%	81%	81%
<b>Hot Water Coil</b>				
Size (Inches)	(2) 30x84x2 Row	(2) 30x84x2 Row	(2) 30x84x2 Row	(2) 30x84x2 Row
Type	5W Prima-Flo E w/ turbulators	5W Prima-Flo E w/ turbulators	5W Prima-Flo E w/ turbulators	5W Prima-Flo E w/ turbulators
High Heat (Fins/Ft)	110	110	110	110
Low Heat (Fins/Ft)	80	80	80	80
<b>Steam Coil</b>				
Size (Inches)	(2) 30x84x1 Row	(2) 30x84x1 Row	(2) 30x84x1 Row	(2) 30x84x1 Row
Type	Type NS	Type NS	Type NS	Type NS
High Heat (Fins/Ft)	96	96	96	96
Low Heat (Fins/Ft)	52	52	52	52
<b>Filters</b>				
Panel Filters (Number/Size - Inches)	25-24x24x2	25-24x24x2	25-24x24x2	25-24x24x2
Face Area (Ft <sup>2</sup> )	100	100	100	100



## General Data

**Table 11. General data - 90 to 130 tons (continued)**

Bag Filters (Number/Size (Inches))	3-12x24x19	3-12x24x19	3-12x24x19	3-12x24x19
	15-24x24x19	15-24x24x19	15-24x24x19	15-24x24x19
Cartridge Filters (Number/Size (Inches))	3-12x24x12	3-12x24x12	3-12x24x12	3-12x24x12
	15-24x24x12	15-24x24x12	15-24x24x12	15-24x24x12
Prefilters (For Bag & Cartridge)	3-20x24x2	3-20x24x2	3-20x24x2	3-20x24x2
	15-24x24x2	15-24x24x2	15-24x24x2	15-24x24x2
Face Area (Ft <sup>2</sup> )	65	66	66	66
<b>Final Filters (SX Units only)</b>				
Cartridge Filters (Number/Size (Inches))	5 - 12x24x12	5 - 12x24x12	5 - 12x24x12	5 - 12x24x12
	10 - 24x24x12	10 - 24x24x12	10 - 24x24x12	10 - 24x24x12
Prefilters for Cartridge Filters (Number/Size (Inches))	5 - 12x24x2	5 - 12x24x2	5 - 12x24x2	5 - 12x24x2
	10 - 24x24x2	10 - 24x24x2	10 - 24x24x2	10 - 24x24x2
Face Area (Ft <sup>2</sup> )	50	50	50	50
<b>Standard Unit Minimum Outside Air Temperature for Mechanical Cooling<sup>(f)</sup></b>				
Without Hot Gas Option	45°F	45°F	45°F	45°F
With Hot Gas Option	45°F	45°F	45°F	45°F
<b>Low Ambient Option Minimum Outside Air Temperature</b>				
Without Hot Gas Option	0°F	0°F	0°F	0°F
With Hot Gas Option	10°F	10°F	10°F	10°F

(a) 90 to 130 ton models are dual circuit.

(b) For CFM values outside these ranges, contact your local Trane sales office.

(c) Refer to Electric heat kW ranges table for availability of kW ranges by voltage.

(d) Two-stage gas heat: 1st stage 50% of heater MBh.

(e) Heating Performance is AHRI and DOE certified.

(f) Maximum return temperatures of 95°F. Any higher, contact Product Support.

**Table 12. EER ratings**

System Description (1)	EER (No Heat)	EER (with Heat) (2)	IEER for VAV (3)	AHRI Net Cooling Capacity
20 Ton, eFlex (V)	10.6	10.5	17.9 / 17.8	262000
25 Ton, Std. Efficiency (S)	10.2	10.1	15.7	308000
25 Ton, High Efficiency (H)	10.9	10.9	16.5	312000
25 Ton, eFlex (V)	10.8	10.7	18	298000
30 Ton, Std. Efficiency (S)	10.0	9.9 / 10	16.3 / 16.2	350000
30 Ton, High Efficiency (H)	11.0	10.8 / 10.9	16.8 / 16.7	336000
30 Ton, eFlex (V)	10.7	10.6	19 / 18.9	360000
40 Ton, Std. Efficiency (S)	10.4	10.2	15.2 / 15.1	465000
40 Ton, High Efficiency (H)	10.8	10.7	16.6 / 16.5	420000
40 Ton, eFlex (V)	10.5	10.4	16.9 / 16.8	460000
50 Ton, Std. Efficiency (S)	10.2	10	15.1 / 14.9	550000
50 Ton, High Efficiency (H)	11.1	10.9	16.9 / 16.8	585000
50 Ton, eFlex (V)	11.0	10.9	17.5	575000
55 Ton, Std. Efficiency (S)	10.7	10.5	15.7 / 15.6	625000
55 Ton, High Efficiency (H)	10.9	10.7	16.7 / 16.5	615000
55 Ton, eFlex (V)	10.7	10.6	17.4 / 17.3	620000
60 Ton, Std. Efficiency (S)	10.3	10.1 / 10.2	16.2 / 16	670000
60 Ton, High Efficiency (H)	10.9	10.8 / 10.9	16.5 / 16.4	685000

**Table 12. EER ratings (continued)**

System Description (1)	EER (No Heat)	EER (with Heat) (2)	IEER for VAV (3)	AHRI Net Cooling Capacity
60 Ton, eFlex (V)	11.0	10.9	18.4 / 18.3	660000

**Notes:**

- When there is a single rating in this column, it indicates that all heat types (Natural Gas, Electric, and Hydronic) have the same EER Value. When there are two ratings, they follow the format of "Gas Heat and Hydronic Heat EER / Electric Heat EER". AHRI capacity is net and includes the effect of fan motor heat. Units are suitable for operation to  $\pm 20\%$  of nominal cfm. Units are certified in accordance with the Unitary Air-Conditioner Equipment certification program, which is based on AHRI Standard 340/360.
- EER and/or IEER are rated at AHRI conditions and in accordance with DOE test procedures.
- When there is a single rating in this column, it indicates that configurations with No Heat have the same IEER value as units with any heater type. When there are two ratings they follow the format of "No Heat IEER / Gas Heat and Hydronic Heat and Electric Heat IEER".
- Cooling performance is rated at 95°F ambient, 80°F entering dry bulb, 67°F entering wet bulb. Gross capacity does not include the effect of fan motor heat. AHRI capacity is net and includes the effect of fan motor heat. Units are suitable for operation to  $\pm 20\%$  of nominal cfm. Units are certified in accordance with the Unitary Air-Conditioner Equipment certification program, which is based on AHRI Standard 340/360.
- EER and/or IEER are rated at AHRI conditions and in accordance with DOE test procedures.
- For simplified verification of your specific unit EER/IEER, and capacity at operating conditions, it is strongly recommended that a TSA (Trane Select Assist) report be run.

**Table 13. Economizer outdoor air damper leakage (of rated airflow)**

	$\Delta P$ Across Dampers (In. WC)	
	0.5 (In.)	1.0 (In.)
Standard	1.5%	2.5%
Optional Low Leak	0.5%	1.0%
Optional Ultra Low Leak	—	3 CFM/Ft <sup>2</sup>

**Note:** Above data for Standard and Low Leak based on tests completed in accordance with AMCA Standard 500 at AMCA Laboratories. Ultra low leak damper leakage rate is AMCA certified and meets California Title 24.

**Table 14. Gas heat inputs/input ranges**

Standard Gas Heat Input (MBh)	Two-Stage Gas Heat		Modulating Gas Heat	
	Low Fire Heat Input (MBh)	High Fire Heat Input (MBh)	Modulating Heat Input Range (MBh)	Ultra Modulating Heat Input Range (MBh)
235	117	235	NA	NA
350	175	350	NA	NA
500	250	500	125 - 500	36 - 500
850	425	850	125 - 850	48 - 850
1000	500	1000	125 - 1000	48 - 1000



# Performance Adjustment Factors

Table 15. Enthalpy of saturated air

Wet Bulb Temperature	Btu Per Lb.
40	15.23
41	15.70
42	16.17
43	16.66
44	17.15
45	17.65
46	18.16
47	18.68
48	19.21
49	19.75
50	20.30
51	20.86
52	21.44
53	22.02
54	22.62
55	23.22
56	23.84
57	24.48
58	25.12
59	25.78
60	26.46
61	27.15
62	27.85
63	28.57
64	29.31
65	30.06
66	30.83
67	31.62
68	32.42
69	33.25
70	34.09
71	34.95
72	35.83
73	36.74
74	37.66
75	38.61



Figure 7. Air density ratios

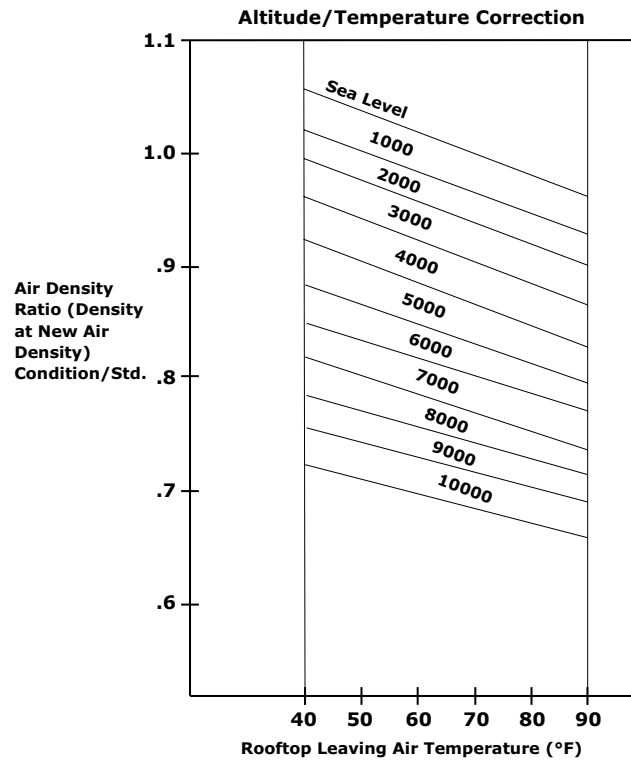

Table 16. Cooling capacity altitude correction factors

	Altitude (ft)								
	Sea Level	1000	2000	3000	4000	5000	6000	7000	8000
Cooling Capacity Multiplier	1.00	1.00	0.99	0.99	0.99	0.98	0.98	0.97	0.97
kW Correction Multiplier	1.00	1.00	1.00	1.00	1.01	1.01	1.01	1.02	1.02
Sensible Heat Ratio Correction Multiplier	1.00	0.97	0.94	0.92	0.89	0.87	0.84	0.81	0.79

Table 17. Gas heating capacity altitude correction factors

	Sea Level to 2000	2001 to 2500	2501 to 3500	3501 to 4500	4501 to 5500	5501 to 6500	6501 to 7500
Capacity Multiplier	1.00	0.92	0.88	0.84	0.80	0.76	0.72

*Note: Correction factors are per ANSI Z223.1/NFPA 54. Local codes may supersede.*



# Performance Data

## Gross Cooling Capacities

Table 18. Gross cooling capacities (MBh) —20 ton air-cooled — eFlex™ variable speed compressor

CFM	Ent DB (°F)	Ambient Temperature (°F)																	
		85						95						105					
		61		67		73		61		67		73		61		67		73	
		CAP	SHC	CAP	SHC	CAP	SHC	CAP	SHC	CAP	SHC	CAP	SHC	CAP	SHC	CAP	SHC	CAP	SHC
4000	75	224	157	251	131	279	103	214	151	240	125	267	97	203	145	228	119	254	91
	80	225	179	251	153	280	126	215	173	240	147	268	120	204	167	229	141	255	114
	85	226	201	252	175	280	148	216	195	241	169	268	142	205	189	229	163	255	136
	90	227	223	253	197	281	170	218	217	242	192	269	164	208	208	230	186	256	158
6000	75	250	193	278	152	305	109	238	186	264	145	289	103	224	178	249	138	273	96
	80	253	225	279	185	305	143	240	218	265	179	290	136	227	211	251	172	274	129
	85	257	257	280	219	306	176	246	246	267	211	291	170	235	235	252	204	275	163
	90	270	270	282	251	307	210	260	260	269	244	292	203	248	248	254	237	276	196
7000	75	259	208	285	161	311	112	245	200	271	154	295	105	231	193	255	147	277	97
	80	262	246	287	200	312	151	249	239	272	193	296	144	235	231	256	186	278	136
	85	272	272	289	238	313	189	260	260	274	231	297	182	247	247	259	223	279	175
	90	286	286	292	276	314	228	274	274	277	269	298	220	261	261	262	261	280	213
8000	75	265	223	291	170	316	114	251	215	275	163	299	106	236	207	259	155	280	99
	80	270	267	293	214	317	158	256	256	277	206	300	151	243	243	261	198	281	143
	85	284	284	295	257	318	202	271	271	280	250	300	195	257	257	263	241	282	188
	90	299	299	300	300	319	245	280	280	286	286	302	237	270	270	271	271	283	229
9000	75	270	238	295	179	320	116	256	230	279	172	302	108	240	222	261	164	282	100
	80	278	278	297	227	320	165	265	265	281	219	302	158	250	250	264	211	283	150
	85	294	294	300	276	322	215	280	280	284	268	303	206	265	265	267	260	284	198
	90	308	308	309	309	324	263	294	294	294	294	305	255	277	277	277	277	285	246
CFM	Ent DB (°F)	Ambient Temperature (°F)																	
		115																	
		Entering Wet Bulb (°F)																	
		61		67		73													
CAP	SHC	CAP	SHC	CAP	SHC														
4000	75	192	138	216	113	240	85												
	80	193	161	216	135	241	107												
	85	194	182	217	157	241	130												
	90	200	200	218	179	242	152												
6000	75	211	170	234	131	255	89												
	80	213	203	235	164	256	122												
	85	223	223	237	197	257	155												
	90	235	235	239	229	258	189												
7000	75	216	185	238	139	259	90												
	80	221	221	240	177	259	129												
	85	234	234	242	215	260	167												
	90	246	246	247	247	261	204												
8000	75	220	199	241	147	261	91												
	80	229	229	243	190	261	135												
	85	242	242	246	233	262	178												
	90	254	254	255	255	263	221												
9000	75	223	213	243	154	262	92												
	80	235	235	245	202	262	142												
	85	248	248	249	249	263	189												
	90	259	259	259	259	264	237												

**Table 19. Gross cooling capacities (MBh) — 25 ton air-cooled — standard efficiency**

CFM	Ent DB (°F)	Ambient Temperature (°F)																	
		85						95						105					
		Entering Wet Bulb (°F)																	
		61		67		73		61		67		73		61		67		73	
		CAP	SHC	CAP	SHC	CAP	SHC	CAP	SHC	CAP	SHC	CAP	SHC	CAP	SHC	CAP	SHC	CAP	SHC
5000	75	269	191	301	158	333	122	257	184	287	151	317	115	243	176	272	143	301	108
	80	270	219	301	186	333	150	258	211	288	179	318	143	245	204	273	171	301	136
	85	272	246	302	213	334	178	260	239	289	206	319	171	247	231	274	199	302	163
	90	275	274	303	241	335	206	264	264	290	234	319	199	253	253	275	226	302	191
7000	75	294	226	325	178	354	127	279	218	308	170	335	119	263	208	291	162	315	111
	80	297	264	326	217	355	166	282	255	310	209	336	158	266	247	292	201	316	150
	85	302	302	328	256	355	205	289	289	311	247	337	197	275	275	294	238	316	189
	90	317	317	330	293	356	244	304	304	314	285	338	236	289	289	296	276	317	227
8750	75	308	253	337	194	363	131	291	244	318	185	342	122	273	234	298	176	320	113
	80	312	301	338	243	365	179	296	292	320	234	344	171	279	279	300	223	321	162
	85	326	326	341	289	366	228	311	311	322	280	345	219	294	294	303	270	322	210
	90	342	342	345	337	367	275	326	326	327	327	346	266	308	308	308	308	324	256
10000	75	315	271	342	205	368	133	297	262	322	196	346	124	278	252	302	186	323	115
	80	321	321	344	258	370	189	305	305	325	249	347	180	288	288	304	239	324	170
	85	338	338	347	312	371	244	322	322	328	303	348	235	303	303	307	293	325	223
	90	354	354	354	354	373	297	336	336	336	336	350	287	316	316	317	317	327	277
11000	75	319	286	345	213	371	135	301	276	325	204	349	126	281	266	303	193	324	116
	80	329	329	348	271	373	196	312	312	327	262	349	187	294	294	306	251	325	177
	85	346	346	351	331	374	255	328	328	331	321	351	245	309	309	309	309	326	234
	90	362	362	363	363	377	314	343	343	343	343	353	304	321	321	322	322	329	294
CFM	Ent DB (°F)	Ambient Temperature (°F)																	
		115																	
		Entering Wet Bulb (°F)																	
		61		67		73		61		67		73		61		67		73	
		CAP	SHC	CAP	SHC	CAP	SHC	CAP	SHC	CAP	SHC	CAP	SHC	CAP	SHC	CAP	SHC	CAP	SHC
5000	75	229	168	256	135	282	100												
	80	230	196	257	163	283	127												
	85	233	223	258	191	283	155												
	90	241	241	259	219	284	183												
7000	75	246	199	271	153	293	102												
	80	249	238	273	192	294	141												
	85	260	260	275	229	294	180												
	90	274	274	277	267	295	218												
8750	75	254	224	277	167	297	104												
	80	262	262	279	213	297	152												
	85	276	276	282	260	298	201												
	90	288	288	289	289	299	246												
10000	75	258	241	279	177	298	105												
	80	270	270	281	228	298	160												
	85	283	283	285	282	299	212												
	90	295	295	295	295	301	266												
11000	75	261	255	280	182	299	106												
	80	274	274	283	240	299	167												
	85	287	287	287	287	300	223												
	90	298	298	299	299	302	282												



**Performance Data**

**Table 20. Gross cooling capacities (MBh) — 25 ton air-cooled — high efficiency**

CFM	Ent DB (°F)	Ambient Temperature (°F)																	
		85						95						105					
		Entering Wet Bulb (°F)						Entering Wet Bulb (°F)						Entering Wet Bulb (°F)					
		61		67		73		61		67		73		61		67		73	
		CAP	SHC	CAP	SHC	CAP	SHC	CAP	SHC	CAP	SHC	CAP	SHC	CAP	SHC	CAP	SHC		
5000	75	278	195	312	163	349	129	264	188	297	155	333	122	250	179	281	147	314	113
	80	279	223	312	191	349	157	265	215	298	183	333	150	251	207	281	175	315	141
	85	280	251	313	219	350	185	267	243	299	211	334	177	253	234	282	203	315	169
	90	283	278	314	247	351	213	270	270	300	239	334	205	258	258	284	230	316	197
7000	75	306	232	341	185	378	137	290	223	323	176	358	128	272	213	303	167	336	119
	80	308	270	342	224	379	176	292	261	324	215	359	167	275	251	305	206	337	158
	85	313	309	344	263	380	215	297	297	326	254	360	206	283	283	307	244	338	197
	90	328	328	347	301	382	254	314	314	329	292	362	245	299	299	310	282	340	236
8750	75	321	259	356	202	393	141	303	250	336	193	370	132	284	239	314	183	346	122
	80	326	308	358	251	394	190	308	298	338	241	372	181	289	287	316	231	348	171
	85	339	339	361	298	396	239	324	324	341	288	374	230	306	306	320	278	349	220
	90	358	358	366	346	398	288	342	342	346	337	376	279	324	324	325	325	352	267
10000	75	330	278	364	214	400	144	311	268	342	204	376	135	290	257	319	193	351	124
	80	336	334	366	268	401	200	318	318	345	258	378	190	300	300	322	247	353	180
	85	355	355	370	322	403	256	338	338	349	312	380	246	319	319	327	301	354	236
	90	375	375	377	377	406	309	357	357	358	358	383	299	337	337	338	338	357	288
11000	75	335	294	368	223	404	146	315	283	346	212	380	136	294	271	322	202	353	126
	80	345	345	372	282	406	208	327	327	350	271	382	198	308	308	326	260	355	187
	85	366	366	376	342	408	269	348	348	355	331	384	259	327	327	331	320	357	246
	90	387	387	387	387	411	327	368	368	368	368	387	317	346	346	347	347	361	306
CFM	Ent DB (°F)	Ambient Temperature (°F)																	
		115																	
		Entering Wet Bulb (°F)																	
		61		67		73		61		67		73		61		67		73	
		CAP	SHC	CAP	SHC	CAP	SHC	CAP	SHC	CAP	SHC	CAP	SHC	CAP	SHC	CAP	SHC		
5000	75	234	171	263	138	294	104												
	80	235	198	264	166	294	132												
	85	237	225	265	194	295	160												
	90	245	245	266	222	296	188												
7000	75	252	202	281	157	311	109												
	80	256	241	283	196	313	148												
	85	266	266	285	234	314	187												
	90	282	282	288	272	316	226												
8750	75	262	228	290	172	319	111												
	80	269	269	292	219	321	160												
	85	287	287	296	267	323	209												
	90	304	304	304	304	325	256												
10000	75	267	245	294	182	322	113												
	80	280	280	297	235	324	169												
	85	298	298	302	290	326	223												
	90	315	315	316	316	329	277												
11000	75	270	259	296	190	324	115												
	80	286	286	300	247	326	176												
	85	305	305	306	306	328	234												
	90	322	322	323	323	332	293												

**Table 21. Gross cooling capacities (MBh) —25 ton air-cooled — eFlex™ variable speed compressor**

CFM	Ent DB (°F)	Ambient Temperature (°F)																	
		85						95						105					
		Entering Wet Bulb (°F)						Entering Wet Bulb (°F)						Entering Wet Bulb (°F)					
		61		67		73		61		67		73		61		67		73	
		CAP	SHC	CAP	SHC	CAP	SHC	CAP	SHC	CAP	SHC	CAP	SHC	CAP	SHC	CAP	SHC	CAP	SHC
5000	75	265	189	298	156	333	122	253	182	284	150	317	115	241	175	270	142	301	108
	80	266	217	298	184	333	150	255	210	285	177	318	143	242	203	271	170	302	136
	85	268	244	299	212	334	178	256	237	286	205	319	171	244	230	272	198	303	164
	90	271	271	300	240	334	206	262	262	287	233	319	199	251	251	273	226	303	192
7000	75	291	224	324	178	358	129	276	216	307	170	339	121	261	207	290	162	319	113
	80	293	262	325	217	359	168	279	254	309	209	340	160	264	246	291	200	321	152
	85	299	299	327	256	360	207	287	287	311	247	341	199	273	273	294	238	322	191
	90	315	315	330	293	361	246	303	303	314	285	343	238	289	289	297	277	323	230
8750	75	305	251	337	194	370	133	289	242	319	186	349	125	271	233	299	177	328	116
	80	310	300	339	243	371	182	294	291	321	234	351	173	278	278	301	224	329	164
	85	325	325	342	290	373	231	310	310	324	281	352	222	295	295	305	271	330	213
	90	343	343	347	338	375	278	328	328	329	329	354	269	311	311	312	312	332	259
10000	75	312	270	343	205	376	136	295	261	324	196	354	127	277	251	303	187	331	118
	80	320	320	346	259	377	192	305	305	327	250	355	183	288	288	306	240	332	173
	85	339	339	350	314	379	247	323	323	331	304	357	238	306	306	311	295	334	227
	90	358	358	359	359	381	300	341	341	342	342	360	291	322	322	323	323	336	281
11000	75	317	285	347	214	379	138	299	275	327	205	357	129	280	265	306	195	333	119
	80	329	329	351	273	381	199	313	313	330	263	358	190	295	295	309	253	334	180
	85	349	349	355	333	383	258	332	332	336	323	360	249	313	313	315	313	336	238
	90	368	368	368	368	385	318	349	349	349	335	363	308	329	329	330	330	339	298
CFM	Ent DB (°F)	Ambient Temperature (°F)																	
		115																	
		Entering Wet Bulb (°F)																	
		61		67		73													
		CAP	SHC	CAP	SHC	CAP	SHC												
5000	75	227	167	255	135	283	100												
	80	229	195	256	162	284	128												
	85	231	222	257	190	285	156												
	90	240	240	258	218	286	184												
7000	75	244	199	271	153	298	104												
	80	248	237	273	192	299	143												
	85	259	259	275	229	300	182												
	90	265	265	278	268	302	221												
8750	75	253	224	279	167	304	106												
	80	262	262	281	214	305	155												
	85	278	278	284	262	306	204												
	90	293	293	293	293	308	249												
10000	75	258	241	282	177	306	108												
	80	270	270	285	230	307	163												
	85	287	287	289	284	309	216												
	90	302	302	302	302	311	270												
11000	75	260	255	283	183	307	109												
	80	276	276	287	242	309	170												
	85	293	293	293	293	310	227												
	90	307	307	307	307	313	287												



**Performance Data**

**Table 22. Gross cooling capacities (MBh) — 30 ton air-cooled — standard efficiency**

CFM	Ent DB (°F)	Ambient Temperature (°F)																	
		85						95						105					
								Entering Wet Bulb (°F)						Entering Wet Bulb (°F)					
		61		67		73		61		67		73		61		67		73	
		CAP	SHC	CAP	SHC	CAP	SHC	CAP	SHC	CAP	SHC	CAP	SHC	CAP	SHC	CAP	SHC	CAP	SHC
6000	75	311	222	346	183	382	139	296	214	331	175	364	131	281	206	314	166	345	123
	80	311	256	347	216	382	173	297	248	331	208	365	165	282	239	314	199	346	156
	85	313	288	348	249	383	206	299	280	332	241	365	198	284	271	315	232	346	190
	90	317	317	348	282	383	240	306	306	333	274	366	232	293	293	316	266	347	223
9000	75	341	273	375	211	406	146	324	264	356	202	385	137	305	254	335	192	362	127
	80	344	321	376	261	407	196	327	312	357	252	386	187	308	302	336	242	363	177
	85	355	355	378	311	408	246	339	339	359	302	386	237	323	323	338	290	363	227
	90	372	372	381	359	408	295	344	344	362	349	387	286	339	339	342	339	364	277
10500	75	350	295	383	224	412	148	331	285	362	215	390	139	311	274	340	205	365	129
	80	355	352	384	282	413	206	337	337	364	273	390	197	319	319	342	263	366	187
	85	372	372	386	338	413	265	355	355	366	328	391	255	337	337	344	318	366	245
	90	390	390	391	391	414	323	372	372	373	373	392	313	352	352	353	353	367	300
12000	75	357	317	388	237	417	151	337	306	367	227	393	141	316	295	343	217	368	131
	80	366	366	390	303	417	217	348	348	368	291	393	207	329	329	345	280	368	197
	85	385	385	393	366	417	284	367	367	372	356	393	274	346	346	349	345	368	263
	90	403	403	403	403	420	347	383	383	383	383	395	336	361	361	361	361	369	325
13500	75	363	339	392	250	420	154	342	328	370	239	394	144	320	316	345	229	368	133
	80	377	377	394	321	420	228	358	358	372	310	395	218	337	337	348	299	368	207
	85	395	395	398	394	422	303	375	375	376	376	395	293	353	353	354	354	369	278
	90	412	412	412	412	425	374	390	390	390	390	399	362	366	366	366	366	371	350
CFM	Ent DB (°F)	Ambient Temperature (°F)																	
		115																	
		Entering Wet Bulb (°F)																	
		61		67		73		61		67		73		61		67		73	
		CAP	SHC	CAP	SHC	CAP	SHC	CAP	SHC	CAP	SHC	CAP	SHC	CAP	SHC	CAP	SHC	CAP	SHC
6000	75	264	197	295	157	324	114												
	80	265	230	296	190	325	147												
	85	267	262	297	223	326	181												
	90	280	280	298	256	326	214												
9000	75	284	242	313	182	337	117												
	80	288	288	314	232	338	167												
	85	305	305	316	280	338	217												
	90	320	320	321	321	339	267												
10500	75	290	263	317	194	340	119												
	80	300	300	318	250	340	177												
	85	316	316	321	306	340	235												
	90	331	331	331	331	341	289												
12000	75	294	283	319	206	340	120												
	80	308	308	321	268	340	186												
	85	324	324	325	325	341	249												
	90	337	337	337	337	341	313												
13500	75	297	297	320	217	340	122												
	80	314	314	322	286	340	196												
	85	329	329	330	330	340	265												
	90	340	340	340	340	342	338												

**Table 23. Gross cooling capacities (MBh) — 30 ton air-cooled — high efficiency**

CFM	Ent DB (°F)	Ambient Temperature (°F)																	
		85						95						105					
		Entering Wet Bulb (°F)						Entering Wet Bulb (°F)						Entering Wet Bulb (°F)					
		61		67		73		61		67		73		61		67		73	
		CAP	SHC	CAP	SHC	CAP	SHC	CAP	SHC	CAP	SHC	CAP	SHC	CAP	SHC	CAP	SHC	CAP	SHC
6000	75	300	217	336	178	375	137	286	209	321	170	357	129	271	201	304	162	338	120
	80	301	250	337	211	376	170	287	242	321	203	358	162	272	234	305	195	339	154
	85	303	283	338	245	376	204	289	275	322	237	359	196	274	267	306	228	340	187
	90	310	310	339	278	377	237	298	298	323	270	359	229	286	286	307	261	341	221
9000	75	330	268	367	208	404	145	312	257	347	199	382	136	294	247	327	189	359	126
	80	334	316	368	258	405	195	316	307	349	249	383	186	298	297	328	239	360	177
	85	347	347	370	308	406	245	331	331	351	297	385	236	303	303	331	287	361	227
	90	351	351	374	356	408	295	350	350	355	346	386	286	333	333	335	335	363	277
10500	75	340	290	376	222	412	148	321	280	355	212	388	139	301	269	333	202	364	129
	80	345	345	378	280	413	207	328	328	356	270	390	197	311	311	334	260	365	187
	85	365	365	381	336	415	265	348	348	360	326	391	256	330	330	338	315	366	246
	90	386	386	387	387	416	324	360	360	369	369	393	314	349	349	349	349	368	301
12000	75	347	313	382	235	417	151	327	302	360	225	393	141	306	291	336	214	367	131
	80	359	359	384	302	419	218	341	341	362	289	394	208	322	322	339	278	368	198
	85	380	380	389	365	420	285	362	362	367	354	396	275	342	342	344	343	370	264
	90	401	401	402	402	422	348	381	381	382	382	398	338	360	360	361	361	372	327
13500	75	353	335	387	248	422	154	332	324	364	237	396	144	311	311	339	226	369	133
	80	370	370	390	320	423	230	351	351	367	308	398	219	331	331	343	297	371	208
	85	393	393	396	394	425	304	370	370	373	373	399	291	351	351	351	351	372	279
	90	414	414	414	414	427	375	392	392	392	392	402	364	369	369	369	369	375	352
CFM	Ent DB (°F)	Ambient Temperature (°F)																	
		115																	
		Entering Wet Bulb (°F)																	
		61		67		73		61		67		73		61		67		73	
		CAP	SHC	CAP	SHC	CAP	SHC	CAP	SHC	CAP	SHC	CAP	SHC	CAP	SHC	CAP	SHC	CAP	SHC
6000	75	255	192	286	153	318	111												
	80	256	225	287	186	319	145												
	85	259	258	288	219	320	178												
	90	273	273	289	253	320	212												
9000	75	274	237	305	179	334	116												
	80	280	280	306	229	335	166												
	85	298	298	309	277	337	217												
	90	315	315	316	316	338	266												
10500	75	280	258	309	191	337	118												
	80	292	292	311	247	339	177												
	85	311	311	315	304	340	235												
	90	328	328	329	329	342	290												
12000	75	284	279	312	203	339	120												
	80	302	302	315	266	341	187												
	85	319	319	321	321	342	250												
	90	337	337	337	337	343	316												
13500	75	289	289	313	215	341	122												
	80	309	309	317	285	342	197												
	85	327	327	328	328	343	267												
	90	343	343	343	343	346	340												



**Performance Data**

**Table 24. Gross cooling capacities (MBh) —30 ton air-cooled — eFlex™ variable speed compressor**

CFM	Ent DB (°F)	Ambient Temperature (°F)																	
		85						95						105					
		Entering Wet Bulb (°F)																	
		61		67		73		61		67		73		61		67		73	
		CAP	SHC	CAP	SHC	CAP	SHC	CAP	SHC	CAP	SHC	CAP	SHC	CAP	SHC	CAP	SHC	CAP	SHC
6000	75	319	227	356	187	395	145	305	219	340	179	377	137	289	210	323	170	357	128
	80	320	260	357	220	395	178	305	252	341	212	377	170	290	243	324	204	358	161
	85	321	293	357	254	396	212	307	284	342	245	378	204	292	276	325	237	359	195
	90	324	324	358	287	396	245	312	312	343	279	379	237	300	300	326	270	359	228
9000	75	352	278	389	217	425	152	334	268	369	207	402	143	315	258	348	197	378	133
	80	354	326	390	267	426	203	337	317	370	257	403	193	318	306	349	247	379	183
	85	364	364	391	317	426	253	348	348	372	307	404	243	332	332	351	296	380	233
	90	383	383	394	365	427	303	354	354	375	355	405	293	334	334	354	345	381	283
10500	75	361	300	398	230	432	155	342	290	376	220	409	146	322	279	354	210	383	135
	80	366	358	399	288	433	214	347	347	378	279	410	204	328	328	355	268	384	194
	85	383	383	402	345	434	272	366	366	381	334	411	262	347	347	358	323	385	252
	90	403	403	406	402	436	330	385	385	386	386	412	320	365	365	366	366	386	310
12000	75	369	323	404	243	438	158	349	312	382	233	413	148	328	300	358	222	386	137
	80	377	377	406	310	439	225	359	359	384	300	414	215	340	340	360	286	387	204
	85	398	398	409	373	440	292	379	379	387	362	415	281	359	359	363	351	388	270
	90	418	418	419	419	442	355	398	398	399	399	417	344	376	376	383	366	390	333
13500	75	376	345	409	256	442	161	354	333	386	246	416	151	332	321	360	234	388	140
	80	389	389	412	328	443	236	370	370	388	317	417	225	349	349	363	305	389	214
	85	411	411	416	402	444	311	390	390	393	390	418	300	368	368	368	368	390	289
	90	430	430	431	431	447	382	409	409	409	409	420	370	384	384	385	385	393	358
CFM	Ent DB (°F)	Ambient Temperature (°F)																	
		115																	
		Entering Wet Bulb (°F)																	
		61		67		73		61		67		73		61		67		73	
		CAP	SHC	CAP	SHC	CAP	SHC	CAP	SHC	CAP	SHC	CAP	SHC	CAP	SHC	CAP	SHC	CAP	SHC
6000	75	273	201	305	161	336	119												
	80	274	234	306	195	337	152												
	85	276	267	307	228	338	185												
	90	287	287	308	261	338	219												
9000	75	295	247	325	187	352	123												
	80	298	296	326	237	353	173												
	85	314	314	328	285	354	223												
	90	331	331	332	332	355	272												
10500	75	300	268	329	199	356	124												
	80	309	309	331	257	357	183												
	85	327	327	334	312	357	241												
	90	343	343	344	344	359	296												
12000	75	305	288	332	211	358	126												
	80	319	319	334	274	358	192												
	85	333	333	338	338	359	259												
	90	352	352	352	352	361	320												
13500	75	308	308	334	222	359	128												
	80	326	326	336	292	359	202												
	85	343	343	344	344	360	272												
	90	358	358	358	358	363	346												



**Table 25. Gross cooling capacities (MBh) — 40 ton air-cooled — standard efficiency**

CFM	Ent DB (°F)	Ambient Temperature (°F)																	
		85						95						105					
								Entering Wet Bulb (°F)						Entering Wet Bulb (°F)					
		61		67		73		61		67		73		61		67		73	
		CAP	SHC	CAP	SHC	CAP	SHC	CAP	SHC	CAP	SHC	CAP	SHC	CAP	SHC	CAP	SHC	CAP	SHC
8000	75	413	296	460	242	509	185	394	285	439	231	485	174	374	274	416	220	459	163
	80	414	340	461	286	509	230	395	329	439	276	485	219	375	318	417	264	460	208
	85	415	383	461	330	510	274	397	372	440	320	486	263	377	361	417	308	461	252
	90	421	421	462	374	510	318	406	406	441	364	487	308	389	389	418	352	461	296
11000	75	447	348	494	273	540	193	424	336	469	261	512	182	401	324	443	249	482	170
	80	449	407	495	333	541	255	427	395	470	322	513	243	404	382	444	310	483	231
	85	457	457	496	394	542	316	438	438	471	382	514	304	418	418	445	370	484	292
	90	480	480	498	453	542	376	461	461	474	441	515	365	440	440	449	428	484	352
14000	75	468	394	513	300	556	200	443	381	486	288	526	188	417	368	457	276	493	175
	80	473	471	514	378	557	278	450	450	487	366	527	266	427	427	459	353	494	253
	85	496	496	517	452	558	355	474	474	490	439	528	343	450	450	462	426	494	330
	90	521	521	523	520	559	432	498	498	498	498	529	420	472	472	473	473	496	406
16000	75	478	425	522	318	564	204	452	411	494	306	532	192	425	398	464	293	498	179
	80	489	489	523	407	564	293	466	466	495	393	533	280	442	442	465	377	498	267
	85	515	515	527	490	565	381	491	491	499	477	533	369	466	466	470	463	499	356
	90	540	540	541	541	567	465	515	515	515	515	535	452	486	486	487	487	501	438
18000	75	486	454	528	336	569	208	460	441	499	324	536	196	432	427	468	310	501	183
	80	504	504	530	431	570	308	480	480	501	418	537	295	454	454	470	403	502	282
	85	531	531	536	528	571	408	505	505	507	507	538	395	477	477	478	478	502	382
	90	555	555	556	556	574	501	527	527	528	528	541	487	497	497	497	497	506	473
CFM	Ent DB (°F)	Ambient Temperature (°F)																	
		115																	
		Entering Wet Bulb (°F)																	
		61		67		73		61		67		73		61		67		73	
		CAP	SHC	CAP	SHC	CAP	SHC	CAP	SHC	CAP	SHC	CAP	SHC	CAP	SHC	CAP	SHC	CAP	SHC
8000	75	352	262	392	209	432	151												
	80	353	306	393	253	432	196												
	85	355	349	394	297	433	240												
	90	371	371	395	341	433	284												
11000	75	376	311	415	237	450	157												
	80	379	369	416	297	451	218												
	85	397	397	418	356	451	279												
	90	417	417	421	415	452	340												
14000	75	390	354	427	263	458	162												
	80	403	403	428	338	459	239												
	85	425	425	431	412	459	317												
	90	444	444	445	445	460	389												
16000	75	398	383	431	280	462	166												
	80	416	416	433	363	462	254												
	85	437	437	438	438	462	342												
	90	455	455	456	456	465	424												
18000	75	404	404	435	296	464	169												
	80	426	426	437	388	464	268												
	85	446	446	447	447	465	361												
	90	464	464	464	464	468	458												



**Performance Data**

**Table 26. Gross cooling capacities (MBh) — 40 ton air-cooled — high efficiency**

CFM	Ent DB (°F)	Ambient Temperature (°F)																	
		85						95						105					
		Entering Wet Bulb (°F)						Entering Wet Bulb (°F)						Entering Wet Bulb (°F)					
		61		67		73		61		67		73		61		67		73	
		CAP	SHC	CAP	SHC	CAP	SHC	CAP	SHC	CAP	SHC	CAP	SHC	CAP	SHC	CAP	SHC	CAP	SHC
8000	75	382	280	424	226	468	169	363	270	404	216	445	158	344	259	382	205	420	148
	80	383	324	425	270	468	213	364	314	405	260	445	203	345	303	383	249	421	192
	85	385	367	426	314	469	257	367	357	405	304	446	247	348	343	384	293	421	237
	90	396	396	427	358	470	302	381	381	407	348	447	292	365	365	385	338	422	281
11000	75	410	330	452	255	493	176	389	320	429	244	467	165	366	306	403	233	438	154
	80	413	389	453	316	494	237	392	378	430	305	467	227	370	366	404	294	439	215
	85	427	427	455	377	495	298	408	408	431	364	468	287	388	388	406	352	440	276
	90	448	448	458	435	495	359	429	429	435	424	469	348	408	408	411	410	440	337
14000	75	428	376	468	283	506	183	405	364	442	271	478	172	380	351	415	259	447	160
	80	436	436	469	360	507	260	416	416	444	348	479	249	394	394	417	333	448	237
	85	460	460	473	433	508	338	439	439	447	421	479	326	415	415	420	409	448	314
	90	483	483	483	483	509	413	460	460	460	460	481	400	435	435	435	435	450	387
16000	75	437	406	475	300	512	187	413	393	448	289	483	176	387	380	420	277	451	164
	80	452	452	477	385	513	275	430	430	450	372	483	264	407	407	422	360	451	252
	85	476	476	481	471	514	364	453	453	455	455	484	352	428	428	428	428	452	338
	90	498	498	499	499	517	447	474	474	474	474	487	435	446	446	447	447	456	422
18000	75	444	435	480	318	517	191	419	419	453	306	487	180	394	394	423	294	454	168
	80	465	465	483	412	518	291	442	442	455	399	487	279	417	417	426	386	454	267
	85	489	489	490	490	520	390	464	464	465	465	489	373	437	437	437	437	456	360
	90	511	511	512	512	524	483	485	485	485	485	493	470	456	456	457	457	460	457
CFM	Ent DB (°F)	Ambient Temperature (°F)																	
		115																	
		Entering Wet Bulb (°F)																	
		61		67		73		61		67		73		61		67		73	
		CAP	SHC	CAP	SHC	CAP	SHC	CAP	SHC	CAP	SHC	CAP	SHC	CAP	SHC	CAP	SHC	CAP	SHC
8000	75	323	248	359	194	394	137												
	80	324	291	359	238	394	181												
	85	329	329	360	282	395	226												
	90	347	347	362	325	396	270												
11000	75	343	294	377	221	408	143												
	80	347	347	378	282	409	203												
	85	367	367	380	340	409	264												
	90	386	386	387	387	410	325												
14000	75	355	338	386	247	415	148												
	80	371	371	388	320	415	225												
	85	391	391	392	390	415	302												
	90	407	407	408	408	418	374												
16000	75	361	361	390	264	418	151												
	80	382	382	392	346	418	239												
	85	400	400	401	401	419	322												
	90	417	417	417	417	422	408												
18000	75	368	368	393	276	420	155												
	80	390	390	395	372	420	254												
	85	407	407	408	408	422	345												
	90	425	425	425	425	426	426												

**Table 27. Gross cooling capacities (MBh) — 40 ton air-cooled — eFlex™ variable speed compressor**

CFM	Ent DB (°F)	Ambient Temperature (°F)																	
		85						95						105					
								Entering Wet Bulb (°F)						Entering Wet Bulb (°F)					
		61		67		73		61		67		73		61		67		73	
		CAP	SHC	CAP	SHC	CAP	SHC	CAP	SHC	CAP	SHC	CAP	SHC	CAP	SHC	CAP	SHC	CAP	SHC
8000	75	405	292	452	239	503	183	387	282	432	229	481	173	368	272	411	219	457	163
	80	405	336	453	283	503	228	388	326	433	273	481	218	369	316	412	263	458	208
	85	407	380	453	327	504	272	388	368	434	317	482	262	371	355	413	307	458	252
	90	416	413	454	371	504	316	400	400	435	361	482	307	385	385	414	351	459	296
11000	75	438	344	486	270	536	193	417	333	463	259	511	182	395	322	439	248	483	171
	80	441	404	487	331	537	254	420	393	464	320	511	243	398	380	440	309	484	232
	85	451	449	489	392	538	315	433	433	466	381	512	304	414	414	442	369	485	293
	90	474	474	491	451	538	376	456	456	469	440	513	365	437	437	446	422	486	354
14000	75	459	392	507	298	555	200	436	380	481	287	527	189	412	367	455	275	497	177
	80	467	454	508	376	556	278	446	440	483	365	528	267	423	423	456	351	498	255
	85	490	490	511	451	557	355	470	470	486	439	529	344	448	448	460	427	499	333
	90	516	516	520	509	558	433	495	495	497	494	530	420	473	473	473	473	501	408
16000	75	469	422	516	317	563	204	446	410	490	305	534	193	421	397	462	293	502	181
	80	483	483	518	404	564	293	462	462	491	392	535	282	439	439	464	379	504	270
	85	510	510	522	490	565	382	488	488	496	473	536	371	465	465	470	452	505	359
	90	537	537	538	538	567	469	514	514	515	515	538	457	490	490	490	490	507	443
18000	75	478	453	523	335	569	209	454	434	496	323	539	197	429	414	467	310	507	185
	80	498	498	525	432	570	309	476	476	498	418	540	297	452	452	470	405	508	285
	85	527	527	533	512	571	408	503	503	507	495	541	395	478	478	480	478	509	382
	90	554	554	555	555	574	503	529	529	530	530	544	491	502	502	503	503	512	478
CFM	Ent DB (°F)	Ambient Temperature (°F)																	
		115																	
		Entering Wet Bulb (°F)																	
		61		67		73		61		67		73		61		67		73	
		CAP	SHC	CAP	SHC	CAP	SHC	CAP	SHC	CAP	SHC	CAP	SHC	CAP	SHC	CAP	SHC	CAP	SHC
8000	75	347	261	389	208	432	152												
	80	348	304	390	252	433	197												
	85	353	341	390	296	433	241												
	90	368	368	392	340	434	285												
11000	75	372	309	413	236	454	159												
	80	376	362	414	297	455	220												
	85	394	394	416	357	456	281												
	90	417	417	422	406	457	342												
14000	75	387	354	427	263	465	165												
	80	401	401	428	339	466	243												
	85	425	425	432	411	467	320												
	90	448	448	449	449	469	396												
16000	75	395	377	432	280	469	169												
	80	415	415	435	365	470	257												
	85	440	440	443	434	471	344												
	90	462	462	463	463	474	429												
18000	75	403	396	436	298	472	172												
	80	427	427	440	392	473	272												
	85	451	451	452	452	474	369												
	90	473	473	473	473	478	458												



**Performance Data**

**Table 28. Gross cooling capacities (MBh) — 50 ton air-cooled —standard efficiency**

CFM	Ent DB (°F)	Ambient Temperature (°F)																	
		85						95						105					
								Entering Wet Bulb (°F)						Entering Wet Bulb (°F)					
		61		67		73		61		67		73		61		67		73	
		CAP	SHC	CAP	SHC	CAP	SHC	CAP	SHC	CAP	SHC	CAP	SHC	CAP	SHC	CAP	SHC	CAP	SHC
10000	75	492	359	546	291	604	220	469	346	522	279	576	208	445	333	495	267	546	195
	80	494	414	547	347	605	276	471	401	523	335	577	264	447	388	497	322	547	251
	85	497	468	549	402	605	332	475	455	525	390	578	319	452	442	498	377	548	307
	90	510	510	551	457	606	387	491	491	527	445	579	375	472	472	501	431	549	362
14000	75	533	426	587	331	640	231	507	412	558	318	608	218	479	397	528	305	574	204
	80	538	502	589	409	642	309	513	488	560	396	610	296	486	474	530	382	575	282
	85	555	555	592	484	643	386	533	533	564	471	611	373	509	509	533	456	576	360
	90	584	584	597	560	644	464	561	561	569	547	612	450	535	535	539	532	578	436
17500	75	556	479	607	364	658	239	528	465	576	350	623	225	498	450	543	336	586	211
	80	567	567	610	457	659	336	542	542	579	443	624	322	515	515	546	428	587	308
	85	597	597	615	552	660	433	571	571	584	538	625	418	543	543	551	522	588	403
	90	626	626	627	627	662	524	599	599	600	600	628	510	569	569	569	569	590	495
20000	75	568	517	617	386	666	244	539	502	584	371	630	230	508	486	550	356	592	216
	80	588	588	621	491	667	355	561	561	588	476	631	341	532	532	554	460	592	326
	85	619	619	627	599	668	463	591	591	595	585	632	449	560	560	562	562	593	430
	90	648	648	649	649	672	568	618	618	618	618	635	553	584	584	585	585	596	537
22500	75	578	554	625	406	673	249	548	539	591	391	636	236	517	517	555	373	596	221
	80	605	605	629	525	673	374	577	577	596	509	636	360	546	546	560	493	596	343
	85	636	636	637	637	675	491	606	606	607	607	637	475	573	573	573	573	597	459
	90	664	664	665	665	680	612	631	631	632	632	642	597	595	595	596	596	601	580
CFM	Ent DB (°F)	Ambient Temperature (°F)																	
		115																	
		Entering Wet Bulb (°F)																	
		61		67		73		61		67		73		61		67		73	
		CAP	SHC	CAP	SHC	CAP	SHC	CAP	SHC	CAP	SHC	CAP	SHC	CAP	SHC	CAP	SHC	CAP	SHC
10000	75	420	320	467	253	514	182												
	80	422	374	469	308	515	238												
	85	428	427	470	364	516	293												
	90	450	450	473	417	517	348												
14000	75	450	382	495	290	537	190												
	80	458	457	497	367	538	268												
	85	482	482	501	441	539	345												
	90	507	507	508	508	541	419												
17500	75	466	434	507	321	547	197												
	80	486	486	510	412	547	293												
	85	512	512	516	506	548	387												
	90	536	536	536	536	550	478												
20000	75	475	470	513	339	551	201												
	80	501	501	517	444	551	311												
	85	527	527	527	527	552	413												
	90	548	548	548	548	554	520												
22500	75	484	484	517	356	555	206												
	80	512	512	522	476	554	326												
	85	537	537	537	537	554	442												
	90	557	557	557	557	559	558												

**Table 29. Gross cooling capacities (MBh) — 50 ton air-cooled —high efficiency**

CFM	Ent DB (°F)	Ambient Temperature (°F)																	
		85						95						105					
		Entering Wet Bulb (°F)						Entering Wet Bulb (°F)						Entering Wet Bulb (°F)					
		61		67		73		61		67		73		61		67		73	
		CAP	SHC	CAP	SHC	CAP	SHC	CAP	SHC	CAP	SHC	CAP	SHC	CAP	SHC	CAP	SHC	CAP	SHC
10000	75	511	369	572	303	639	235	489	357	547	291	610	222	465	344	520	278	580	209
	80	513	424	573	359	639	291	491	412	548	346	611	278	467	399	522	333	581	265
	85	516	478	574	414	640	346	495	466	550	401	612	334	471	453	523	388	582	320
	90	526	526	576	469	642	402	508	508	552	457	614	389	489	489	525	443	584	376
14000	75	558	439	621	346	688	249	532	425	591	332	654	235	504	409	559	318	618	221
	80	564	515	623	424	690	327	538	501	593	410	656	313	510	486	562	396	621	299
	85	578	578	626	500	692	405	556	556	597	487	658	391	532	532	566	470	623	377
	90	610	610	632	576	694	483	587	587	603	562	661	469	562	562	572	547	625	455
17500	75	585	494	646	380	713	258	556	479	614	365	676	244	526	463	579	350	637	229
	80	596	587	650	476	715	356	569	568	617	461	679	342	541	541	583	444	640	327
	85	628	628	656	570	718	454	602	602	624	555	681	439	574	574	590	539	643	424
	90	663	663	668	661	722	549	636	636	638	638	686	532	607	607	608	608	647	516
20000	75	600	532	660	403	725	265	570	517	625	388	686	250	538	500	589	371	645	234
	80	618	618	664	510	728	376	591	591	630	494	690	361	562	562	594	478	649	346
	85	656	656	672	619	731	486	627	627	639	603	693	471	597	597	604	587	652	455
	90	693	693	694	694	736	593	663	663	664	664	698	577	631	631	632	632	658	560
22500	75	612	570	670	424	734	270	581	554	634	409	694	255	547	535	596	392	652	239
	80	640	640	676	544	738	396	611	611	641	528	698	381	580	580	603	511	656	365
	85	679	679	687	668	742	518	648	648	653	646	702	500	615	615	618	618	660	483
	90	717	717	718	718	748	638	685	685	686	686	709	622	650	650	651	651	667	604
CFM	Ent DB (°F)	Ambient Temperature (°F)																	
		115																	
		Entering Wet Bulb (°F)																	
		61		67		73		61		67		73		61		67		73	
		CAP	SHC	CAP	SHC	CAP	SHC	CAP	SHC	CAP	SHC	CAP	SHC	CAP	SHC	CAP	SHC	CAP	SHC
10000	75	440	330	492	264	547	195												
	80	442	384	493	319	549	251												
	85	447	438	495	375	550	306												
	90	468	468	497	430	551	362												
14000	75	474	394	526	303	580	206												
	80	481	470	528	380	582	284												
	85	506	506	532	455	585	362												
	90	535	535	540	530	587	438												
17500	75	493	446	542	334	595	213												
	80	512	512	547	427	598	311												
	85	543	543	554	522	601	406												
	90	575	575	576	576	606	499												
20000	75	504	483	550	354	602	218												
	80	531	531	556	460	606	330												
	85	564	564	567	563	609	435												
	90	596	596	596	596	615	543												
22500	75	514	512	557	375	607	223												
	80	546	546	564	493	611	348												
	85	580	580	581	581	615	465												
	90	612	612	613	613	622	586												



**Performance Data**

**Table 30. Gross cooling capacities (MBh) — 50 ton air-cooled — eFlex™ variable speed compressor**

CFM	Ent DB (°F)	Ambient Temperature (°F)																	
		85						95						105					
								Entering Wet Bulb (°F)						Entering Wet Bulb (°F)					
		61		67		73		61		67		73		61		67		73	
		CAP	SHC	CAP	SHC	CAP	SHC	CAP	SHC	CAP	SHC	CAP	SHC	CAP	SHC	CAP	SHC	CAP	SHC
10000	75	519	373	580	307	648	238	497	361	556	295	620	226	474	348	530	282	591	213
	80	521	428	581	362	648	294	499	416	557	350	621	282	476	403	532	338	592	269
	85	524	482	582	418	649	350	502	470	559	406	622	338	480	457	533	393	593	325
	90	532	532	584	473	650	405	515	515	561	461	623	393	496	496	535	448	595	380
14000	75	567	443	630	350	698	253	541	430	601	336	666	239	514	414	571	323	631	225
	80	572	519	632	428	700	331	547	505	603	414	668	318	520	491	573	400	633	304
	85	585	585	635	505	702	409	563	563	607	491	670	396	540	540	577	475	636	382
	90	617	617	641	580	704	487	595	595	613	566	672	473	570	570	583	552	638	459
17500	75	595	498	657	384	724	262	566	483	625	370	688	248	537	468	591	355	650	234
	80	604	595	660	480	727	360	577	576	628	466	691	346	550	550	595	449	654	331
	85	635	635	666	574	729	458	610	610	635	559	694	443	583	583	602	544	656	429
	90	671	671	676	669	733	553	645	645	648	648	698	537	617	617	618	618	660	521
20000	75	609	537	670	407	737	269	580	521	637	393	699	254	549	505	602	377	660	239
	80	626	626	675	514	740	380	600	600	642	499	703	366	572	572	607	483	663	351
	85	664	664	683	623	743	490	637	637	650	608	706	475	607	607	616	592	666	460
	90	702	702	703	703	748	597	673	673	674	674	711	582	642	642	643	643	672	566
22500	75	622	575	681	430	746	275	591	559	646	414	707	260	559	542	609	397	666	244
	80	648	648	687	549	750	400	620	620	652	533	711	385	590	590	616	516	670	370
	85	688	688	697	672	754	523	658	658	664	656	715	507	627	627	629	629	674	488
	90	727	727	728	728	760	642	695	695	696	696	721	626	662	662	663	663	681	610
CFM	Ent DB (°F)	Ambient Temperature (°F)																	
		115																	
		Entering Wet Bulb (°F)																	
		61		67		73		61		67		73		61		67		73	
		CAP	SHC	CAP	SHC	CAP	SHC	CAP	SHC	CAP	SHC	CAP	SHC	CAP	SHC	CAP	SHC	CAP	SHC
10000	75	450	335	503	269	560	200												
	80	452	389	504	324	561	256												
	85	456	444	506	380	562	311												
	90	476	476	508	435	564	367												
14000	75	486	399	538	308	594	211												
	80	492	476	541	386	596	289												
	85	515	515	545	460	599	367												
	90	544	544	551	537	601	444												
17500	75	506	452	556	340	610	218												
	80	522	522	560	433	613	316												
	85	554	554	567	528	616	412												
	90	586	586	587	587	620	505												
20000	75	516	489	564	360	617	223												
	80	542	542	570	466	621	335												
	85	576	576	580	575	624	443												
	90	608	608	609	609	630	548												
22500	75	526	524	571	381	623	228												
	80	558	558	578	499	627	354												
	85	593	593	593	593	631	470												
	90	625	625	626	626	637	592												

**Table 31. Gross cooling capacities (MBh) — 55 ton air-cooled — standard efficiency**

CFM	Ent DB (°F)	Ambient Temperature (°F)																	
		85						95						105					
								Entering Wet Bulb (°F)						Entering Wet Bulb (°F)					
		61		67		73		61		67		73		61		67		73	
		CAP	SHC	CAP	SHC	CAP	SHC	CAP	SHC	CAP	SHC	CAP	SHC	CAP	SHC	CAP	SHC	CAP	SHC
10000	75	550	389	614	324	684	254	527	377	589	311	654	241	503	363	561	297	622	227
	80	551	445	615	379	684	310	529	432	590	366	655	296	504	419	562	352	623	282
	85	554	499	616	434	685	365	532	486	591	421	656	352	508	472	563	407	624	338
	90	559	554	618	489	686	421	539	539	593	477	657	407	518	518	565	463	625	393
14000	75	603	462	669	367	737	268	576	447	638	352	701	253	547	432	604	337	662	237
	80	608	537	671	445	738	346	581	522	640	430	702	331	552	507	607	415	664	315
	85	617	612	673	522	739	423	592	592	643	507	704	409	567	567	610	491	666	393
	90	647	647	678	597	741	501	623	623	648	582	706	486	597	597	615	566	667	471
17500	75	633	517	697	401	762	276	603	501	663	385	723	261	571	485	626	369	681	245
	80	641	613	700	498	764	374	612	597	666	481	725	358	581	577	629	465	683	342
	85	668	668	705	591	766	471	641	641	671	575	727	456	611	611	634	558	685	439
	90	703	703	713	687	769	567	674	674	680	670	730	551	643	643	645	645	687	534
20000	75	649	556	712	424	775	282	617	539	675	408	734	266	583	522	636	391	690	250
	80	662	661	715	533	777	393	632	632	679	515	736	377	601	601	640	497	691	361
	85	697	697	721	640	779	504	667	667	686	623	738	488	635	635	647	605	693	470
	90	733	733	735	735	782	610	702	702	703	703	741	593	667	667	668	668	697	575
22500	75	662	593	722	447	784	288	629	576	685	430	742	271	594	558	644	412	696	254
	80	683	683	727	566	787	413	653	653	689	548	744	396	620	620	649	530	698	379
	85	721	721	735	688	789	535	689	689	698	671	746	519	654	654	658	652	700	501
	90	758	758	759	759	793	655	723	723	724	724	751	637	685	685	686	686	705	619
CFM	Ent DB (°F)	Ambient Temperature (°F)																	
		115																	
		Entering Wet Bulb (°F)																	
		61		67		73		61		67		73		61		67		73	
		CAP	SHC	CAP	SHC	CAP	SHC	CAP	SHC	CAP	SHC	CAP	SHC	CAP	SHC	CAP	SHC	CAP	SHC
10000	75	476	349	531	282	587	211												
	80	478	404	532	337	588	267												
	85	481	458	533	393	589	323												
	90	497	497	535	448	590	378												
14000	75	515	415	568	321	620	221												
	80	520	490	570	398	622	299												
	85	539	539	573	473	623	376												
	90	568	568	579	549	625	454												
17500	75	536	467	586	352	635	227												
	80	548	548	589	447	637	324												
	85	579	579	595	540	638	421												
	90	608	608	609	609	641	513												
20000	75	547	503	594	374	642	232												
	80	568	568	598	478	644	343												
	85	599	599	606	586	646	451												
	90	628	628	628	628	649	556												
22500	75	556	539	601	393	647	236												
	80	584	584	605	510	649	361												
	85	615	615	616	616	651	478												
	90	643	643	643	643	656	599												



**Performance Data**

**Table 32. Gross cooling capacities (MBh) — 55 ton air-cooled —high efficiency**

CFM	Ent DB (°F)	Ambient Temperature (°F)																	
		85						95						105					
		Entering Wet Bulb (°F)						Entering Wet Bulb (°F)						Entering Wet Bulb (°F)					
		61		67		73		61		67		73		61		67		73	
		CAP	SHC	CAP	SHC	CAP	SHC	CAP	SHC	CAP	SHC	CAP	SHC	CAP	SHC	CAP	SHC	CAP	SHC
10000	75	529	378	592	313	661	244	507	366	567	301	633	232	484	354	541	288	602	218
	80	530	434	593	368	661	300	509	422	569	356	633	288	486	409	542	343	603	274
	85	533	488	594	424	662	356	512	476	570	411	634	343	489	463	544	398	604	330
	90	541	541	596	479	663	411	523	523	572	467	636	399	504	504	546	454	606	385
14000	75	579	450	644	356	712	259	553	436	614	343	679	245	525	421	583	328	642	230
	80	584	525	646	434	714	337	559	511	617	420	681	323	531	497	585	406	644	308
	85	596	596	649	511	716	415	573	573	620	497	682	401	550	550	589	481	646	386
	90	628	628	654	587	718	492	605	605	625	572	685	478	580	580	594	557	649	464
17500	75	608	505	671	390	738	268	579	490	639	376	701	253	549	474	604	360	661	238
	80	617	601	674	486	740	365	589	584	642	472	704	351	561	561	607	456	664	335
	85	647	647	680	580	743	463	621	621	648	565	706	448	593	593	614	549	666	433
	90	683	683	689	677	746	559	656	656	659	657	709	544	626	626	627	627	670	525
20000	75	624	544	685	413	751	274	593	528	651	398	712	259	561	511	614	383	670	243
	80	639	639	689	521	753	385	612	612	655	505	715	370	583	583	619	488	673	354
	85	676	676	697	629	756	496	648	648	663	614	717	480	617	617	627	597	676	464
	90	713	713	714	714	760	602	683	683	684	684	722	586	651	651	652	652	680	569
22500	75	636	581	696	436	760	279	605	565	660	419	720	264	571	548	622	403	677	248
	80	661	661	701	555	763	405	632	632	666	539	723	389	601	601	628	522	680	373
	85	700	700	711	678	766	527	669	669	676	662	726	512	636	636	639	639	683	492
	90	738	738	739	739	772	647	705	705	706	706	732	630	670	670	671	671	688	613
CFM	Ent DB (°F)	Ambient Temperature (°F)																	
		115																	
		Entering Wet Bulb (°F)																	
		61		67		73		61		67		73		61		67		73	
		CAP	SHC	CAP	SHC	CAP	SHC	CAP	SHC	CAP	SHC	CAP	SHC	CAP	SHC	CAP	SHC	CAP	SHC
10000	75	458	340	512	274	569	204												
	80	461	395	514	329	570	260												
	85	465	449	515	384	572	316												
	90	483	483	517	439	573	371												
14000	75	495	405	549	313	603	215												
	80	501	481	551	390	605	293												
	85	524	524	555	465	607	370												
	90	553	553	561	542	609	448												
17500	75	516	457	566	344	618	222												
	80	531	531	570	437	621	319												
	85	563	563	576	532	623	416												
	90	594	594	595	595	627	508												
20000	75	527	494	575	365	626	226												
	80	551	551	580	470	628	338												
	85	584	584	588	579	631	446												
	90	614	614	615	615	635	551												
22500	75	536	530	581	385	631	231												
	80	567	567	587	503	633	356												
	85	600	600	601	601	637	473												
	90	630	630	631	631	642	594												



**Table 33. Gross cooling capacities (MBh) — 55 ton air-cooled — eFlex™ variable speed compressor**

CFM	Ent DB (°F)	Ambient Temperature (°F)																	
		85						95						105					
								Entering Wet Bulb (°F)						Entering Wet Bulb (°F)					
		61		67		73		61		67		73		61		67		73	
		CAP	SHC	CAP	SHC	CAP	SHC	CAP	SHC	CAP	SHC	CAP	SHC	CAP	SHC	CAP	SHC	CAP	SHC
10000	75	547	388	612	322	682	253	525	375	586	309	653	240	501	362	559	296	622	226
	80	549	443	613	377	683	309	527	431	587	365	654	296	502	417	561	351	623	282
	85	551	498	614	433	683	364	529	485	589	420	655	351	506	471	562	406	624	337
	90	558	550	615	488	684	420	538	535	590	475	656	407	517	517	564	462	626	393
14000	75	601	460	667	366	737	268	574	445	636	351	703	253	545	430	604	336	665	238
	80	605	535	669	443	739	346	578	521	639	429	704	331	550	506	606	414	667	316
	85	615	608	672	520	741	424	591	591	642	506	706	409	565	565	609	491	669	394
	90	645	645	676	596	743	501	621	621	647	581	708	487	596	596	615	566	672	472
17500	75	631	516	696	400	765	277	601	500	662	385	727	262	569	483	626	369	686	246
	80	639	612	699	497	767	375	610	595	665	481	729	359	580	574	630	465	689	344
	85	666	666	704	591	769	472	640	640	671	575	732	457	611	611	636	558	691	441
	90	702	702	713	687	772	568	675	675	681	667	735	552	645	645	648	646	694	536
20000	75	647	554	711	423	778	283	615	538	675	408	738	267	582	521	637	391	696	251
	80	661	656	715	533	781	395	631	631	680	517	741	379	601	601	642	497	698	363
	85	696	696	722	640	784	506	668	668	687	623	744	489	636	636	650	606	701	472
	90	734	734	738	738	788	612	704	704	705	705	748	596	671	671	672	672	706	578
22500	75	660	592	722	446	788	289	628	575	685	429	747	273	593	558	646	412	703	256
	80	682	682	727	566	791	414	652	652	691	549	750	398	620	620	652	531	706	382
	85	722	722	737	688	795	537	690	690	700	671	753	521	657	657	662	649	709	503
	90	760	760	762	762	800	657	727	727	728	728	759	640	691	691	692	692	715	622
CFM	Ent DB (°F)	Ambient Temperature (°F)																	
		115																	
		Entering Wet Bulb (°F)																	
		61		67		73		61		67		73		61		67		73	
		CAP	SHC	CAP	SHC	CAP	SHC	CAP	SHC	CAP	SHC	CAP	SHC	CAP	SHC	CAP	SHC	CAP	SHC
10000	75	475	348	530	281	589	211												
	80	477	403	531	337	590	267												
	85	480	457	533	392	591	323												
	90	496	496	535	447	592	378												
14000	75	514	414	569	320	625	222												
	80	520	489	571	398	628	300												
	85	539	539	575	473	630	378												
	90	568	568	580	549	632	456												
17500	75	536	466	588	352	642	229												
	80	549	549	592	447	645	327												
	85	580	580	598	541	647	424												
	90	612	612	613	613	651	516												
20000	75	547	503	597	374	650	234												
	80	569	569	602	479	653	345												
	85	603	603	610	588	656	454												
	90	635	635	635	635	660	560												
22500	75	556	539	604	393	656	239												
	80	586	586	610	512	659	364												
	85	620	620	623	623	662	482												
	90	652	652	653	653	667	602												



**Performance Data**

**Table 34. Gross cooling capacities (MBh) — 60 ton air-cooled —standard efficiency**

CFM	Ent DB (°F)	Ambient Temperature (°F)																	
		85						95						105					
								Entering Wet Bulb (°F)						Entering Wet Bulb (°F)					
		61		67		73		61		67		73		61		67		73	
		CAP	SHC	CAP	SHC	CAP	SHC	CAP	SHC	CAP	SHC	CAP	SHC	CAP	SHC	CAP	SHC	CAP	SHC
14000	75	627	468	700	375	775	277	595	450	666	358	737	260	561	431	628	339	696	242
	80	629	545	702	453	777	356	597	527	668	435	739	338	563	507	630	417	698	320
	85	634	621	704	530	778	433	604	594	669	513	740	416	574	571	632	494	700	398
	90	659	659	706	608	780	511	633	633	672	590	742	494	604	604	635	571	701	476
18000	75	661	534	735	413	807	287	625	514	695	394	764	268	586	493	653	374	718	248
	80	666	630	737	513	808	387	631	610	698	494	766	368	593	584	656	474	721	349
	85	688	688	740	613	810	487	657	657	701	593	768	469	624	624	659	573	723	449
	90	726	726	745	709	812	587	694	694	706	682	770	568	660	660	668	655	725	549
21000	75	679	581	751	440	821	293	640	558	709	420	776	273	599	536	665	399	728	253
	80	689	679	754	557	824	410	653	652	712	536	778	390	615	615	668	515	730	370
	85	724	724	758	671	826	527	690	690	717	650	781	507	653	653	673	626	733	487
	90	763	763	769	763	828	643	728	728	729	729	783	623	690	690	692	692	736	603
24000	75	693	625	764	467	832	299	652	601	719	445	784	278	609	577	672	423	734	257
	80	710	710	767	600	835	433	674	674	723	578	787	412	636	636	676	556	737	391
	85	752	752	773	726	837	566	715	715	730	705	790	545	676	676	684	667	739	524
	90	793	793	794	794	840	699	754	754	755	755	793	678	713	713	714	714	743	654
27000	75	704	668	773	493	840	305	661	644	726	471	791	284	616	611	677	448	738	261
	80	733	733	777	642	843	455	694	694	730	620	793	434	653	653	682	594	741	412
	85	776	776	785	767	846	605	736	736	742	736	796	584	693	693	694	694	743	562
	90	816	816	817	817	850	751	775	775	776	776	800	729	731	731	731	731	748	702
CFM	Ent DB (°F)	Ambient Temperature (°F)																	
		115																	
		Entering Wet Bulb (°F)																	
		61		67		73		61		67		73		61		67		73	
		CAP	SHC	CAP	SHC	CAP	SHC	CAP	SHC	CAP	SHC	CAP	SHC	CAP	SHC	CAP	SHC	CAP	SHC
14000	75	524	411	588	319	652	222												
	80	527	487	590	397	654	301												
	85	541	541	592	474	656	379												
	90	573	573	596	551	658	456												
18000	75	545	470	608	353	669	228												
	80	556	552	611	453	672	328												
	85	589	589	615	550	674	428												
	90	623	623	625	625	676	528												
21000	75	555	511	617	377	676	231												
	80	577	577	620	493	679	348												
	85	614	614	626	603	681	465												
	90	649	649	650	650	684	582												
24000	75	563	551	622	400	679	235												
	80	595	595	626	530	683	369												
	85	633	633	637	635	685	502												
	90	668	668	669	669	689	627												
27000	75	571	571	625	424	681	238												
	80	608	608	630	565	685	389												
	85	647	647	648	648	687	539												
	90	682	682	683	683	693	677												

**Table 35. Gross cooling capacities (MBh) — 60 ton air-cooled — high efficiency**

CFM	Ent DB (°F)	Ambient Temperature (°F)																	
		85						95						105					
		Entering Wet Bulb (°F)						Entering Wet Bulb (°F)						Entering Wet Bulb (°F)					
		61		67		73		61		67		73		61		67		73	
		CAP	SHC	CAP	SHC	CAP	SHC	CAP	SHC	CAP	SHC	CAP	SHC	CAP	SHC	CAP	SHC	CAP	SHC
14000	75	647	478	725	386	810	291	615	460	690	368	771	273	582	441	653	350	730	255
	80	648	555	727	464	811	370	617	537	692	446	772	352	584	518	655	427	731	333
	85	653	630	728	541	813	448	622	613	694	524	774	430	591	590	657	505	733	411
	90	675	675	730	619	814	525	649	649	696	601	776	507	622	622	659	582	735	489
18000	75	684	544	765	426	850	303	648	525	725	406	806	283	610	504	682	386	758	263
	80	689	641	767	526	852	404	653	621	727	506	808	384	616	600	685	486	761	364
	85	707	707	770	625	855	504	677	677	730	606	811	484	644	644	688	585	763	464
	90	748	748	775	724	857	604	717	717	736	702	813	584	683	683	695	681	766	564
21000	75	704	593	785	454	870	310	665	572	742	433	822	290	624	550	696	412	771	268
	80	712	705	788	571	873	428	675	675	745	550	825	407	637	637	700	528	775	386
	85	747	747	792	687	876	545	713	713	750	666	828	524	677	677	705	642	778	503
	90	791	791	802	799	878	661	756	756	761	761	831	641	718	718	720	720	781	619
24000	75	719	640	800	481	885	317	678	613	755	460	834	296	634	589	706	437	780	273
	80	735	735	804	615	888	452	698	698	758	593	838	430	660	660	710	570	784	407
	85	780	780	810	745	892	585	743	743	765	720	841	564	703	703	718	697	788	541
	90	826	826	828	828	895	719	788	788	789	789	845	697	747	747	748	748	792	675
27000	75	732	681	812	508	896	324	689	657	764	485	843	301	643	632	713	462	786	278
	80	759	759	817	658	900	475	721	721	769	635	847	453	679	679	718	612	791	429
	85	808	808	826	801	904	625	768	768	779	777	851	603	725	725	730	730	795	579
	90	856	856	857	857	908	776	814	814	815	815	856	753	769	769	770	770	801	726
CFM	Ent DB (°F)	Ambient Temperature (°F)																	
		115																	
		Entering Wet Bulb (°F)																	
		61		67		73		61		67		73		61		67		73	
		CAP	SHC	CAP	SHC	CAP	SHC	CAP	SHC	CAP	SHC	CAP	SHC	CAP	SHC	CAP	SHC	CAP	SHC
14000	75	546	421	613	330	685	235												
	80	548	499	615	408	686	313												
	85	559	559	617	485	688	391												
	90	591	591	620	563	690	469												
18000	75	569	483	637	364	707	241												
	80	576	576	640	464	710	342												
	85	609	609	643	564	713	443												
	90	647	647	653	648	716	542												
21000	75	580	523	648	389	717	246												
	80	598	598	651	506	721	363												
	85	638	638	657	616	724	480												
	90	678	678	679	679	727	597												
24000	75	589	565	655	413	723	250												
	80	619	619	659	546	727	384												
	85	661	661	668	668	731	518												
	90	702	702	703	703	736	651												
27000	75	596	596	659	437	727	254												
	80	635	635	664	583	732	405												
	85	679	679	680	680	735	555												
	90	721	721	722	722	742	695												



**Performance Data**

**Table 36. Gross cooling capacities (MBh) — 60 ton air-cooled — eFlex™ variable speed compressor**

CFM	Ent DB (°F)	Ambient Temperature (°F)																	
		85						95						105					
								Entering Wet Bulb (°F)						Entering Wet Bulb (°F)					
		61		67		73		61		67		73		61		67		73	
		CAP	SHC	CAP	SHC	CAP	SHC	CAP	SHC	CAP	SHC	CAP	SHC	CAP	SHC	CAP	SHC	CAP	SHC
14000	75	624	466	700	375	782	281	594	449	667	358	745	263	562	432	631	341	706	246
	80	626	544	702	453	783	359	596	527	669	436	746	342	565	509	633	418	707	324
	85	631	617	703	530	785	437	604	592	670	513	748	420	575	571	635	496	709	402
	90	657	657	706	608	787	514	633	633	673	591	750	497	606	606	638	572	711	480
18000	75	659	533	737	415	819	292	624	514	699	396	777	273	588	494	659	376	732	254
	80	664	631	739	514	822	393	630	610	701	496	780	374	595	583	662	476	735	355
	85	687	687	742	614	824	493	658	658	704	595	782	474	627	627	665	576	738	455
	90	727	727	748	712	827	593	697	697	711	691	785	574	665	665	673	659	741	555
21000	75	677	581	756	442	838	299	640	559	715	423	792	280	601	538	672	402	744	259
	80	688	676	759	559	841	417	654	651	718	539	796	397	618	618	675	519	748	377
	85	725	725	763	673	844	534	692	692	723	653	799	514	658	658	681	632	751	494
	90	768	768	776	765	847	650	734	734	739	739	802	631	699	699	700	700	755	610
24000	75	692	625	770	470	851	306	653	601	726	449	803	285	612	579	681	427	752	264
	80	711	711	774	603	855	441	676	676	730	582	808	420	640	640	685	560	757	398
	85	756	756	780	733	859	574	721	721	738	709	811	554	683	683	694	679	761	532
	90	802	802	803	803	863	708	765	765	766	766	815	687	726	726	727	727	765	662
27000	75	704	668	781	496	862	313	663	644	735	475	811	291	620	611	687	452	758	269
	80	735	735	785	646	867	464	698	698	740	621	816	442	658	658	692	598	763	420
	85	783	783	796	779	871	614	744	744	752	745	820	593	703	703	708	708	767	570
	90	830	830	832	832	876	761	790	790	791	791	826	739	747	747	748	748	774	716
CFM	Ent DB (°F)	Ambient Temperature (°F)																	
		115																	
		Entering Wet Bulb (°F)																	
		61		67		73		61		67		73		61		67		73	
		CAP	SHC	CAP	SHC	CAP	SHC	CAP	SHC	CAP	SHC	CAP	SHC	CAP	SHC	CAP	SHC	CAP	SHC
14000	75	528	413	594	322	663	227												
	80	531	489	596	400	665	305												
	85	544	544	598	477	667	383												
	90	577	577	601	553	669	461												
18000	75	550	472	616	356	684	233												
	80	560	554	619	456	687	334												
	85	594	594	623	554	690	435												
	90	630	630	635	631	693	535												
21000	75	560	514	626	381	693	238												
	80	582	582	629	497	697	355												
	85	621	621	636	608	701	472												
	90	660	660	661	661	704	589												
24000	75	569	554	632	405	699	242												
	80	601	601	636	535	703	376												
	85	642	642	649	641	707	510												
	90	683	683	684	684	712	639												
27000	75	577	574	636	429	702	246												
	80	617	617	642	570	707	397												
	85	660	660	661	661	711	547												
	90	701	701	702	702	718	687												

**Table 37. Gross cooling capacities (MBh) — 70 ton air-cooled —standard efficiency**

CFM	Ent DB (°F)	Ambient Temperature (°F)																	
		85						95						105					
								Entering Wet Bulb (°F)						Entering Wet Bulb (°F)					
		61		67		73		61		67		73		61		67		73	
		CAP	SHC	CAP	SHC	CAP	SHC	CAP	SHC	CAP	SHC	CAP	SHC	CAP	SHC	CAP	SHC	CAP	SHC
16000	75	770	569	853	456	931	334	732	547	811	434	885	312	691	525	766	412	834	290
	80	773	661	855	548	933	427	735	639	813	526	886	405	694	616	768	504	836	383
	85	778	752	857	640	935	519	744	722	815	618	888	498	706	693	770	596	838	475
	90	805	805	859	731	936	611	773	773	818	710	890	590	739	739	774	687	839	568
20000	75	806	636	886	493	958	341	763	613	839	470	906	318	717	589	789	446	850	294
	80	812	750	889	608	960	457	770	727	842	585	909	434	725	700	792	561	852	410
	85	833	833	892	723	962	572	795	795	845	701	911	549	755	755	796	675	854	526
	90	874	874	898	837	965	687	836	836	852	810	913	665	794	794	806	778	857	641
22000	75	819	669	898	511	967	344	774	645	849	488	913	321	727	619	796	463	855	296
	80	827	794	900	638	970	471	785	760	852	614	915	448	741	725	799	590	857	424
	85	857	857	904	764	972	598	818	818	856	739	917	575	776	776	804	714	859	551
	90	900	900	914	879	974	725	859	859	869	848	920	702	814	814	820	812	862	677
24000	75	830	702	907	529	974	347	784	675	856	505	918	323	735	649	802	479	858	298
	80	843	823	910	667	977	486	800	789	859	643	920	462	754	754	805	618	860	437
	85	880	880	915	803	979	625	838	838	865	779	922	601	793	793	812	753	862	576
	90	922	922	930	914	982	763	878	878	879	879	926	739	830	830	831	831	866	714
26000	75	840	731	914	547	980	351	792	706	862	522	922	326	741	679	806	496	860	301
	80	858	851	918	696	982	501	813	813	866	672	925	477	766	766	810	646	863	451
	85	898	898	924	843	985	651	854	854	873	818	927	627	806	806	818	788	866	601
	90	940	940	942	942	989	801	894	894	895	895	932	777	843	843	844	844	870	748
27000	75	844	747	918	556	983	353	796	721	865	530	924	328	744	694	807	504	862	302
	80	865	865	921	711	986	509	818	818	868	686	927	484	772	772	812	657	864	458
	85	907	907	929	863	988	665	862	862	877	838	930	640	812	812	822	793	867	614
	90	949	949	950	950	993	821	901	901	902	902	934	793	848	848	849	849	872	766
CFM	Ent DB (°F)	Ambient Temperature (°F)																	
		115																	
		Entering Wet Bulb (°F)																	
		61		67		73		61		67		73		61		67		73	
		CAP	SHC	CAP	SHC	CAP	SHC	CAP	SHC	CAP	SHC	CAP	SHC	CAP	SHC	CAP	SHC	CAP	SHC
16000	75	647	501	717	388	779	266												
	80	650	592	719	480	781	359												
	85	666	665	721	572	782	452												
	90	701	701	726	663	784	544												
20000	75	668	562	735	421	790	269												
	80	680	662	738	536	792	385												
	85	712	712	742	649	794	500												
	90	749	749	755	742	796	616												
22000	75	676	592	740	437	792	270												
	80	693	692	743	564	794	398												
	85	729	729	749	688	796	525												
	90	765	765	766	766	799	652												
24000	75	682	622	743	453	794	272												
	80	705	705	747	591	796	411												
	85	743	743	755	723	798	550												
	90	777	777	778	778	802	685												
26000	75	687	651	746	469	795	274												
	80	716	716	750	616	797	425												
	85	754	754	761	742	800	575												
	90	786	786	787	787	804	721												
27000	75	689	665	747	477	795	275												
	80	721	721	751	629	797	431												
	85	759	759	764	754	800	588												
	90	790	790	790	790	806	739												



**Performance Data**

**Table 38. Gross cooling capacities (MBh) — 70 ton air-cooled —high efficiency**

CFM	Ent DB (°F)	Ambient Temperature (°F)																	
		85						95						105					
		Entering Wet Bulb (°F)						Entering Wet Bulb (°F)						Entering Wet Bulb (°F)					
		61		67		73		61		67		73		61		67		73	
		CAP	SHC	CAP	SHC	CAP	SHC	CAP	SHC	CAP	SHC	CAP	SHC	CAP	SHC	CAP	SHC	CAP	SHC
16000	75	733	549	822	442	920	331	697	529	782	422	877	311	659	508	741	401	830	290
	80	736	640	824	533	922	423	700	620	785	513	878	403	663	599	743	492	832	382
	85	743	730	826	624	924	515	709	706	787	604	881	495	676	676	746	583	834	474
	90	776	776	830	715	926	606	747	747	791	696	883	586	715	715	750	675	837	566
20000	75	769	617	861	482	960	343	729	595	817	460	911	321	687	573	770	438	859	299
	80	776	729	864	596	963	458	737	707	820	575	914	437	696	684	773	552	863	414
	85	803	803	868	711	966	573	769	769	824	689	918	551	733	733	778	667	866	529
	90	850	850	876	824	969	687	815	815	833	800	921	666	778	778	788	778	870	644
22000	75	783	650	875	502	975	348	741	628	829	479	924	326	697	603	780	456	870	303
	80	793	773	879	627	978	475	753	750	833	605	927	453	712	712	784	582	874	430
	85	832	832	884	753	981	601	795	795	839	731	931	579	757	757	790	706	878	556
	90	881	881	895	875	985	727	844	844	852	845	935	705	804	804	806	806	882	682
24000	75	796	683	888	521	987	353	752	658	839	498	934	330	706	631	789	474	878	307
	80	810	810	892	658	991	492	770	770	844	635	938	469	728	728	793	611	883	445
	85	857	857	898	793	994	629	818	818	851	770	942	607	778	778	802	743	887	583
	90	909	909	915	915	999	767	869	869	871	871	947	744	827	827	829	829	892	721
26000	75	806	714	898	539	997	358	761	687	848	516	942	335	714	661	795	491	884	310
	80	827	827	903	688	1001	508	787	787	853	664	947	485	745	745	801	640	890	461
	85	880	880	911	835	1006	657	839	839	863	808	952	634	796	796	812	783	895	610
	90	933	933	935	935	1011	806	892	892	893	893	957	783	847	847	849	849	901	759
27000	75	811	730	903	549	1002	361	765	702	852	525	946	337	717	676	798	500	887	312
	80	836	836	907	703	1006	516	796	796	857	679	951	493	753	753	804	654	893	468
	85	890	890	917	852	1011	671	849	849	868	828	956	648	805	805	817	802	898	623
	90	945	945	947	947	1016	826	902	902	904	904	962	803	857	857	858	858	905	779
CFM	Ent DB (°F)	Ambient Temperature (°F)																	
		115																	
		Entering Wet Bulb (°F)																	
		61		67		73		61		67		73		61		67		73	
		CAP	SHC	CAP	SHC	CAP	SHC	CAP	SHC	CAP	SHC	CAP	SHC	CAP	SHC	CAP	SHC	CAP	SHC
16000	75	618	486	696	379	780	268												
	80	622	576	698	470	783	360												
	85	642	642	701	562	785	452												
	90	681	681	706	652	788	544												
20000	75	641	549	720	414	804	276												
	80	654	652	724	529	808	391												
	85	694	694	729	642	812	506												
	90	738	738	743	743	816	621												
22000	75	650	578	728	432	812	279												
	80	669	669	732	558	817	406												
	85	715	715	740	679	821	533												
	90	762	762	763	763	826	659												
24000	75	657	605	735	449	818	282												
	80	686	686	740	586	824	421												
	85	734	734	749	718	828	559												
	90	782	782	784	784	834	697												
26000	75	664	635	740	465	823	285												
	80	701	701	745	615	829	435												
	85	750	750	758	755	834	585												
	90	800	800	801	801	841	731												
27000	75	667	649	742	474	825	287												
	80	707	707	748	626	832	443												
	85	758	758	764	762	837	598												
	90	808	808	810	810	845	750												

**Table 39. Gross cooling capacities (MBh) — 70 ton air-cooled — eFlex™ variable speed compressor**

CFM	Ent DB (°F)	Ambient Temperature (°F)																	
		85						95						105					
								Entering Wet Bulb (°F)						Entering Wet Bulb (°F)					
		61		67		73		61		67		73		61		67		73	
		CAP	SHC	CAP	SHC	CAP	SHC	CAP	SHC	CAP	SHC	CAP	SHC	CAP	SHC	CAP	SHC	CAP	SHC
16000	75	759	565	850	456	949	343	723	544	811	436	904	322	685	523	769	415	858	301
	80	761	655	852	548	951	436	725	635	813	528	907	415	687	613	771	507	860	394
	85	773	729	854	640	953	528	740	705	815	620	909	508	705	679	773	599	862	487
	90	798	798	857	731	955	621	767	767	818	710	911	600	736	736	777	689	865	579
20000	75	798	633	891	497	991	355	757	610	847	475	941	333	715	587	800	452	888	310
	80	805	737	894	612	994	471	767	709	850	590	944	449	728	680	803	568	892	426
	85	832	819	898	726	997	587	795	791	854	704	947	565	756	756	807	681	895	542
	90	874	874	907	828	1000	703	839	839	867	799	951	681	802	802	824	769	899	658
22000	75	813	666	906	517	1006	360	771	642	860	494	954	337	726	618	810	470	899	314
	80	826	771	910	643	1010	488	787	742	863	621	958	465	745	712	814	597	903	442
	85	857	857	914	768	1013	616	819	819	868	745	961	593	781	781	820	721	907	569
	90	906	906	932	868	1017	743	868	868	889	838	965	720	828	828	844	807	911	694
24000	75	826	698	919	536	1019	365	782	674	870	512	964	342	735	649	819	488	907	317
	80	845	803	923	674	1023	505	804	773	874	651	969	481	760	742	823	624	912	457
	85	881	881	929	810	1027	644	843	843	882	786	973	621	802	802	832	751	916	596
	90	934	934	953	907	1031	780	894	894	909	876	978	757	852	852	862	845	922	732
26000	75	837	730	930	554	1030	370	792	706	879	530	973	346	744	673	826	505	914	321
	80	862	835	934	702	1034	521	819	804	884	677	978	497	774	769	831	652	919	472
	85	905	905	943	850	1038	672	864	864	894	811	983	648	821	821	846	777	924	623
	90	959	959	973	945	1044	819	917	917	926	911	989	795	872	872	873	873	931	770
27000	75	842	747	935	564	1034	373	796	719	883	539	977	348	749	680	829	514	917	323
	80	870	850	939	717	1039	530	826	816	888	692	982	505	780	780	835	666	922	480
	85	916	916	949	861	1044	686	874	874	902	825	987	662	830	830	852	791	927	637
	90	971	971	982	964	1050	839	927	927	935	929	994	814	881	881	883	883	935	789
CFM	Ent DB (°F)	Ambient Temperature (°F)																	
		115																	
		Entering Wet Bulb (°F)																	
		61		67		73		61		67		73		61		67		73	
		CAP	SHC	CAP	SHC	CAP	SHC	CAP	SHC	CAP	SHC	CAP	SHC	CAP	SHC	CAP	SHC	CAP	SHC
16000	75	644	501	724	392	807	279												
	80	647	588	726	485	810	372												
	85	668	652	729	577	812	465												
	90	702	702	733	661	815	557												
20000	75	669	563	749	428	832	286												
	80	686	650	753	544	836	402												
	85	718	718	758	657	839	518												
	90	762	762	778	738	843	634												
22000	75	679	593	758	445	840	289												
	80	701	680	762	570	845	417												
	85	739	739	769	692	849	545												
	90	786	786	796	775	853	670												
24000	75	687	619	764	462	846	292												
	80	714	707	769	598	851	432												
	85	758	758	782	715	856	571												
	90	806	806	812	809	862	707												
26000	75	696	636	770	479	851	295												
	80	727	727	775	626	857	446												
	85	775	775	794	742	861	597												
	90	824	824	825	825	869	744												
27000	75	700	646	772	487	853	296												
	80	732	732	778	639	859	454												
	85	782	782	799	755	864	607												
	90	832	832	834	834	873	762												



**Performance Data**

**Table 40. Gross cooling capacities (MBh) — 75 ton air-cooled —standard efficiency**

CFM	Ent DB (°F)	Ambient Temperature (°F)																	
		85						95						105					
		Entering Wet Bulb (°F)																	
		61		67		73		61		67		73		61		67		73	
		CAP	SHC	CAP	SHC	CAP	SHC	CAP	SHC	CAP	SHC	CAP	SHC	CAP	SHC	CAP	SHC	CAP	SHC
16000	75	822	595	917	485	1020	370	783	573	875	463	972	347	742	550	829	439	920	324
	80	824	686	919	577	1021	462	786	665	877	555	973	440	745	642	831	532	921	416
	85	829	779	921	669	1023	555	791	756	879	647	975	533	752	732	833	624	923	509
	90	848	848	923	760	1025	647	817	817	882	738	977	625	783	783	837	715	926	601
20000	75	866	665	963	526	1064	381	822	641	914	502	1010	357	776	616	862	477	951	331
	80	871	780	965	641	1066	497	828	757	917	617	1012	473	782	730	865	592	953	447
	85	885	885	969	756	1069	613	846	846	921	732	1015	588	807	807	869	707	956	563
	90	929	929	975	871	1071	728	892	892	927	848	1017	704	851	851	877	821	959	678
22000	75	882	698	980	545	1080	386	837	674	929	520	1023	361	788	648	874	495	961	335
	80	889	824	983	672	1082	513	845	798	932	647	1025	488	797	772	878	621	964	462
	85	913	913	987	799	1085	641	874	874	937	774	1028	616	832	832	883	748	967	590
	90	963	963	995	925	1088	767	923	923	946	900	1032	742	879	879	893	871	971	716
24000	75	896	732	994	564	1093	390	849	706	940	539	1033	365	798	680	884	512	969	338
	80	906	869	997	703	1096	530	860	841	944	677	1036	504	811	811	888	650	973	477
	85	941	941	1003	841	1099	668	899	899	950	816	1039	643	855	855	894	789	976	616
	90	993	993	1014	976	1102	806	950	950	963	950	1043	781	903	903	905	905	980	754
26000	75	908	764	1005	583	1104	395	859	738	950	557	1042	368	807	709	892	529	976	341
	80	922	911	1009	733	1107	545	874	874	954	707	1045	519	826	826	896	679	979	492
	85	966	966	1016	883	1110	696	922	922	962	857	1048	669	875	875	904	827	983	642
	90	1020	1020	1030	1020	1114	845	974	974	976	976	1053	819	924	924	926	926	987	792
27000	75	914	781	1011	593	1108	397	864	755	954	566	1045	370	811	725	895	538	978	342
	80	929	929	1015	748	1111	553	881	881	959	721	1049	527	833	833	900	694	982	499
	85	978	978	1023	904	1115	709	932	932	967	875	1052	683	884	884	909	847	985	655
	90	1032	1032	1034	1034	1119	865	985	985	986	986	1057	839	934	934	935	935	991	811
CFM	Ent DB (°F)	Ambient Temperature (°F)																	
		115																	
		Entering Wet Bulb (°F)																	
		61		67		73		61		67		73		61		67		73	
		CAP	SHC	CAP	SHC	CAP	SHC	CAP	SHC	CAP	SHC	CAP	SHC	CAP	SHC	CAP	SHC	CAP	SHC
16000	75	698	525	780	415	863	299												
	80	701	618	782	507	865	392												
	85	710	706	784	599	867	484												
	90	746	746	788	691	870	576												
20000	75	726	590	807	450	888	304												
	80	734	702	810	566	890	421												
	85	764	764	814	681	893	536												
	90	807	807	823	793	896	652												
22000	75	736	621	816	467	895	307												
	80	747	744	820	594	898	435												
	85	787	787	825	721	901	562												
	90	832	832	838	838	905	689												
24000	75	744	650	823	484	901	309												
	80	762	762	827	623	904	449												
	85	806	806	835	759	907	587												
	90	852	852	854	854	911	726												
26000	75	751	680	829	501	904	312												
	80	776	776	834	651	908	463												
	85	824	824	843	795	912	613												
	90	870	870	871	871	917	763												
27000	75	754	692	831	509	906	313												
	80	783	783	836	665	910	469												
	85	831	831	846	814	913	626												
	90	878	878	879	879	919	782												



**Table 41. Gross cooling capacities (MBh) — 75 ton air-cooled —high efficiency**

CFM	Ent DB (°F)	Ambient Temperature (°F)																	
		85						95						105					
								Entering Wet Bulb (°F)						Entering Wet Bulb (°F)					
		61		67		73		61		67		73		61		67		73	
		CAP	SHC	CAP	SHC	CAP	SHC	CAP	SHC	CAP	SHC	CAP	SHC	CAP	SHC	CAP	SHC	CAP	SHC
16000	75	847	606	945	497	1048	382	808	584	901	474	998	358	766	560	853	450	943	333
	80	850	697	947	588	1049	473	811	674	903	565	999	450	768	650	855	541	944	425
	85	854	788	949	679	1051	565	815	765	905	656	1001	541	774	741	858	632	946	516
	90	870	865	951	770	1053	656	835	835	908	747	1003	633	799	799	861	723	948	608
20000	75	894	676	993	538	1093	392	849	651	943	513	1036	366	801	625	888	486	973	339
	80	899	790	996	652	1095	507	854	765	946	627	1038	481	807	738	891	600	975	454
	85	912	893	999	765	1098	621	871	863	949	740	1040	596	827	827	895	714	978	569
	90	951	951	1004	879	1100	735	912	912	955	855	1043	710	870	870	901	827	981	683
22000	75	912	709	1011	557	1109	396	865	684	958	531	1049	370	814	657	901	504	983	342
	80	918	834	1014	682	1111	523	872	808	961	656	1051	496	822	781	904	629	985	468
	85	939	937	1017	807	1114	648	897	897	965	782	1054	622	851	851	908	754	988	594
	90	985	985	1025	932	1117	774	944	944	973	906	1057	748	898	898	918	878	991	720
24000	75	927	742	1025	576	1122	401	877	716	970	549	1059	373	825	688	910	521	990	345
	80	936	878	1028	712	1124	538	888	852	973	686	1061	511	836	817	914	657	993	482
	85	965	965	1033	849	1127	676	921	921	979	823	1064	648	875	875	920	795	996	620
	90	1016	1016	1043	985	1131	812	971	971	989	951	1068	785	922	922	934	913	1000	756
26000	75	940	775	1037	594	1133	405	888	748	980	567	1067	377	834	717	918	538	996	347
	80	952	923	1041	742	1135	554	902	884	984	715	1070	526	852	842	922	686	999	496
	85	990	990	1047	891	1139	702	944	944	990	863	1073	674	895	895	929	832	1002	645
	90	1043	1043	1060	1026	1142	851	995	995	1007	989	1077	823	943	943	949	946	1006	793
27000	75	946	791	1043	603	1137	407	893	764	984	575	1070	378	838	732	921	546	998	348
	80	960	938	1047	757	1140	562	911	895	988	729	1074	533	859	857	925	700	1001	503
	85	1002	1002	1054	911	1143	716	955	955	996	881	1077	688	904	904	934	851	1005	658
	90	1055	1055	1069	1045	1148	870	1006	1006	1015	1004	1081	842	952	952	953	953	1009	812
CFM	Ent DB (°F)	Ambient Temperature (°F)																	
		115																	
		Entering Wet Bulb (°F)																	
		61		67		73		61		67		73		61		67		73	
		CAP	SHC	CAP	SHC	CAP	SHC	CAP	SHC	CAP	SHC	CAP	SHC	CAP	SHC	CAP	SHC	CAP	SHC
16000	75	720	534	801	424	882	306												
	80	723	625	804	515	884	398												
	85	731	710	806	606	886	490												
	90	761	761	809	697	888	581												
20000	75	749	598	829	458	905	310												
	80	756	710	832	572	907	425												
	85	780	780	836	686	909	540												
	90	823	823	844	798	912	654												
22000	75	759	628	839	475	911	312												
	80	769	749	842	600	914	439												
	85	804	804	847	726	916	564												
	90	847	847	859	836	920	690												
24000	75	768	657	845	491	915	314												
	80	784	773	849	628	918	452												
	85	824	824	856	762	921	589												
	90	867	867	873	869	925	726												
26000	75	775	687	851	507	919	316												
	80	796	796	855	655	922	465												
	85	840	840	863	801	925	614												
	90	884	884	885	885	929	762												
27000	75	778	701	853	515	920	317												
	80	802	802	857	669	923	472												
	85	848	848	866	820	926	626												
	90	891	891	892	892	930	780												



**Performance Data**

**Table 42. Gross cooling capacities (MBh) — 75 ton air-cooled — eFlex™ variable speed compressor**

CFM	Ent DB (°F)	Ambient Temperature (°F)																	
		85						95						105					
								Entering Wet Bulb (°F)						Entering Wet Bulb (°F)					
		61		67		73		61		67		73		61		67		73	
		CAP	SHC	CAP	SHC	CAP	SHC	CAP	SHC	CAP	SHC	CAP	SHC	CAP	SHC	CAP	SHC	CAP	SHC
16000	75	802	584	896	476	998	362	765	563	855	454	951	340	726	541	811	432	901	317
	80	804	675	898	567	999	454	767	654	857	546	952	432	728	632	813	523	903	410
	85	809	765	900	658	1001	546	773	737	859	637	954	524	737	707	815	614	905	501
	90	831	829	902	749	1002	637	801	801	862	728	956	615	768	768	819	706	906	593
20000	75	845	653	941	516	1041	373	803	630	894	493	988	349	758	606	844	469	932	325
	80	850	766	943	630	1043	488	809	743	896	607	990	465	765	719	847	583	934	440
	85	868	851	946	744	1045	603	830	823	900	721	993	579	791	791	851	697	936	555
	90	911	911	952	857	1048	717	875	875	907	834	995	694	836	836	858	808	939	669
22000	75	861	687	957	536	1056	378	817	663	908	511	1001	353	770	638	856	486	941	328
	80	868	811	960	661	1059	504	825	783	911	637	1003	480	780	743	859	612	944	455
	85	895	895	964	787	1061	630	857	857	915	763	1006	606	816	816	864	738	947	581
	90	944	944	973	911	1064	756	905	905	925	878	1009	732	863	863	876	836	950	707
24000	75	874	720	971	554	1069	382	829	695	919	530	1011	357	780	670	865	504	949	331
	80	884	838	974	691	1071	520	841	807	922	667	1013	495	796	773	868	641	952	469
	85	922	922	979	829	1074	658	882	882	929	804	1017	633	839	839	875	776	955	607
	90	974	974	991	947	1078	795	932	932	944	908	1020	770	887	887	894	873	959	744
26000	75	886	752	982	573	1079	386	839	725	928	547	1019	361	789	698	872	521	955	334
	80	902	870	986	721	1082	536	857	837	932	696	1022	510	811	803	876	669	958	484
	85	946	946	993	871	1085	685	904	904	940	842	1025	659	858	858	885	816	961	633
	90	1000	1000	1011	979	1089	834	955	955	962	944	1030	808	907	907	911	910	966	782
27000	75	892	769	987	582	1084	389	843	740	933	556	1022	362	792	713	875	529	957	335
	80	910	885	991	736	1087	544	865	852	937	711	1025	518	817	817	879	684	961	491
	85	958	958	999	889	1090	699	914	914	946	863	1029	673	867	867	889	835	964	646
	90	1012	1012	1021	997	1094	853	966	966	971	963	1034	827	917	917	918	918	969	800
CFM	Ent DB (°F)	Ambient Temperature (°F)																	
		115																	
		Entering Wet Bulb (°F)																	
		61		67		73		61		67		73		61		67		73	
		CAP	SHC	CAP	SHC	CAP	SHC	CAP	SHC	CAP	SHC	CAP	SHC	CAP	SHC	CAP	SHC	CAP	SHC
16000	75	683	518	764	409	847	293												
	80	687	608	766	500	849	386												
	85	699	678	769	591	851	477												
	90	733	733	772	683	853	569												
20000	75	711	581	791	443	871	299												
	80	719	683	794	558	873	414												
	85	751	751	798	672	876	529												
	90	793	793	808	765	878	643												
22000	75	721	612	800	460	878	301												
	80	735	710	803	586	880	428												
	85	773	773	809	710	883	554												
	90	817	817	825	802	887	680												
24000	75	729	641	807	477	883	303												
	80	749	739	810	614	886	442												
	85	792	792	818	749	889	579												
	90	838	838	841	837	893	717												
26000	75	735	670	812	493	886	306												
	80	761	761	816	642	890	455												
	85	809	809	826	780	893	605												
	90	855	855	856	856	898	754												
27000	75	738	685	814	501	888	307												
	80	768	768	819	656	891	462												
	85	816	816	830	791	895	617												
	90	862	862	864	864	900	772												

**Table 43. Gross cooling capacities (MBh) — 90 ton air-cooled — standard efficiency**

CFM	Ent DB (°F)	Ambient Temperature (°F)																	
		85						95						105					
		Entering Wet Bulb (°F)						Entering Wet Bulb (°F)						Entering Wet Bulb (°F)					
		61		67		73		61		67		73		61		67		73	
		CAP	SHC	CAP	SHC	CAP	SHC	CAP	SHC	CAP	SHC	CAP	SHC	CAP	SHC	CAP	SHC	CAP	SHC
27000	75	1030	827	1145	641	1265	446	1030	827	1145	641	1265	446	1030	827	1145	641	1265	446
	80	1040	975	1149	796	1267	602	1040	975	1149	796	1267	602	1040	975	1149	796	1267	602
	85	1067	1067	1153	950	1270	757	1067	1067	1153	950	1270	757	1067	1067	1153	950	1270	757
	90	1127	1127	1163	1096	1273	912	1127	1127	1163	1096	1273	912	1127	1127	1163	1096	1273	912
32000	75	1063	907	1178	689	1295	458	1063	907	1178	689	1295	458	1063	907	1178	689	1295	458
	80	1079	1079	1182	873	1298	643	1079	1079	1182	873	1298	643	1079	1079	1182	873	1298	643
	85	1131	1131	1189	1046	1302	827	1131	1131	1189	1046	1302	827	1131	1131	1189	1046	1302	827
	90	1194	1194	1202	1196	1305	1011	1194	1194	1202	1196	1305	1011	1194	1194	1202	1196	1305	1011
37000	75	1089	982	1202	736	1317	470	1089	982	1202	736	1317	470	1089	982	1202	736	1317	470
	80	1115	1115	1207	949	1321	684	1115	1115	1207	949	1321	684	1115	1115	1207	949	1321	684
	85	1181	1181	1217	1146	1324	897	1181	1181	1217	1146	1324	897	1181	1181	1217	1146	1324	897
	90	1246	1246	1248	1248	1329	1102	1246	1246	1248	1248	1329	1102	1246	1246	1248	1248	1329	1102
42000	75	1110	1059	1220	783	1333	481	1110	1059	1220	783	1333	481	1110	1059	1220	783	1333	481
	80	1153	1153	1226	1010	1337	724	1153	1153	1226	1010	1337	724	1153	1153	1226	1010	1337	724
	85	1221	1221	1233	1215	1341	965	1221	1221	1233	1215	1341	965	1221	1221	1233	1215	1341	965
	90	1288	1288	1289	1289	1348	1187	1288	1288	1289	1289	1348	1187	1288	1288	1289	1289	1348	1187
45000	75	1121	1105	1229	811	1341	488	1121	1105	1229	811	1341	488	1121	1105	1229	811	1341	488
	80	1172	1172	1235	1052	1345	748	1172	1172	1235	1052	1345	748	1172	1172	1235	1052	1345	748
	85	1242	1242	1243	1243	1349	1006	1242	1242	1243	1243	1349	1006	1242	1242	1243	1243	1349	1006
	90	1309	1309	1310	1310	1357	1242	1309	1309	1310	1310	1357	1242	1309	1309	1310	1310	1357	1242
CFM	Ent DB (°F)	Ambient Temperature (°F)																	
		115																	
		Entering Wet Bulb (°F)																	
		61		67		73		61		67		73		61		67		73	
		CAP	SHC	CAP	SHC	CAP	SHC	CAP	SHC	CAP	SHC	CAP	SHC	CAP	SHC	CAP	SHC	CAP	SHC
27000	75	1030	827	1145	641	1265	446												
	80	1040	975	1149	796	1267	602												
	85	1067	1067	1153	950	1270	757												
	90	1127	1127	1163	1096	1273	912												
32000	75	1063	907	1178	689	1295	458												
	80	1079	1079	1182	873	1298	643												
	85	1131	1131	1189	1046	1302	827												
	90	1194	1194	1202	1196	1305	1011												
37000	75	1089	982	1202	736	1317	470												
	80	1115	1115	1207	949	1321	684												
	85	1181	1181	1217	1146	1324	897												
	90	1246	1246	1248	1248	1329	1102												
42000	75	1110	1059	1220	783	1333	481												
	80	1153	1153	1226	1010	1337	724												
	85	1221	1221	1233	1215	1341	965												
	90	1288	1288	1289	1289	1348	1187												
45000	75	1121	1105	1229	811	1341	488												
	80	1172	1172	1235	1052	1345	748												
	85	1242	1242	1243	1243	1349	1006												
	90	1309	1309	1310	1310	1357	1242												



**Performance Data**

**Table 44. Gross cooling capacities (MBh) — 90 ton air-cooled —high efficiency**

CFM	Ent DB (°F)	Ambient Temperature (°F)																	
		85						95						105					
		Entering Wet Bulb (°F)						Entering Wet Bulb (°F)						Entering Wet Bulb (°F)					
		61		67		73		61		67		73		61		67		73	
		CAP	SHC	CAP	SHC	CAP	SHC	CAP	SHC	CAP	SHC	CAP	SHC	CAP	SHC	CAP	SHC	CAP	SHC
27000	75	1072	845	1195	661	1328	471	1072	845	1195	661	1328	471	1072	845	1195	661	1328	471
	80	1083	994	1199	815	1332	627	1083	994	1199	815	1332	627	1083	994	1199	815	1332	627
	85	1112	1112	1205	970	1336	781	1112	1112	1205	970	1336	781	1112	1112	1205	970	1336	781
	90	1175	1175	1217	1118	1339	935	1175	1175	1217	1118	1339	935	1175	1175	1217	1118	1339	935
32000	75	1110	923	1232	711	1365	485	1110	923	1232	711	1365	485	1110	923	1232	711	1365	485
	80	1127	1105	1237	893	1370	669	1127	1105	1237	893	1370	669	1127	1105	1237	893	1370	669
	85	1183	1183	1247	1068	1374	853	1183	1183	1247	1068	1374	853	1183	1183	1247	1068	1374	853
	90	1252	1252	1266	1251	1380	1036	1252	1252	1266	1251	1380	1036	1252	1252	1266	1251	1380	1036
37000	75	1139	1002	1259	758	1392	498	1139	1002	1259	758	1392	498	1139	1002	1259	758	1392	498
	80	1168	1168	1266	966	1398	711	1168	1168	1266	966	1398	711	1168	1168	1266	966	1398	711
	85	1241	1241	1281	1170	1402	923	1241	1241	1281	1170	1402	923	1241	1241	1281	1170	1402	923
	90	1314	1314	1316	1316	1411	1124	1314	1314	1316	1316	1411	1124	1314	1314	1316	1316	1411	1124
42000	75	1163	1080	1281	805	1412	510	1163	1080	1281	805	1412	510	1163	1080	1281	805	1412	510
	80	1212	1212	1290	1034	1419	752	1212	1212	1290	1034	1419	752	1212	1212	1290	1034	1419	752
	85	1289	1289	1310	1270	1424	992	1289	1289	1310	1270	1424	992	1289	1289	1310	1270	1424	992
	90	1365	1365	1367	1367	1434	1217	1365	1365	1367	1367	1434	1217	1365	1365	1367	1367	1434	1217
45000	75	1176	1126	1291	833	1422	518	1176	1126	1291	833	1422	518	1176	1126	1291	833	1422	518
	80	1235	1235	1302	1076	1429	776	1235	1235	1302	1076	1429	776	1235	1235	1302	1076	1429	776
	85	1314	1314	1316	1316	1434	1028	1314	1314	1316	1316	1434	1028	1314	1314	1316	1316	1434	1028
	90	1391	1391	1393	1393	1446	1272	1391	1391	1393	1393	1446	1272	1391	1391	1393	1393	1446	1272
CFM	Ent DB (°F)	Ambient Temperature (°F)																	
		115																	
		Entering Wet Bulb (°F)																	
		61		67		73		61		67		73		61		67		73	
		CAP	SHC	CAP	SHC	CAP	SHC	CAP	SHC	CAP	SHC	CAP	SHC	CAP	SHC	CAP	SHC	CAP	SHC
27000	75	1072	845	1195	661	1328	471												
	80	1083	994	1199	815	1332	627												
	85	1112	1112	1205	970	1336	781												
	90	1175	1175	1217	1118	1339	935												
32000	75	1110	923	1232	711	1365	485												
	80	1127	1105	1237	893	1370	669												
	85	1183	1183	1247	1068	1374	853												
	90	1252	1252	1266	1251	1380	1036												
37000	75	1139	1002	1259	758	1392	498												
	80	1168	1168	1266	966	1398	711												
	85	1241	1241	1281	1170	1402	923												
	90	1314	1314	1316	1316	1411	1124												
42000	75	1163	1080	1281	805	1412	510												
	80	1212	1212	1290	1034	1419	752												
	85	1289	1289	1310	1270	1424	992												
	90	1365	1365	1367	1367	1434	1217												
45000	75	1176	1126	1291	833	1422	518												
	80	1235	1235	1302	1076	1429	776												
	85	1314	1314	1316	1316	1434	1028												
	90	1391	1391	1393	1393	1446	1272												

**Table 45. Gross cooling capacities (MBh) — 105 ton air-cooled —standard efficiency**

CFM	Ent DB (°F)	Ambient Temperature (°F)																	
		85						95						105					
		Entering Wet Bulb (°F)																	
		61		67		73		61		67		73		61		67		73	
CAP	SHC	CAP	SHC	CAP	SHC	CAP	SHC	CAP	SHC	CAP	SHC	CAP	SHC	CAP	SHC	CAP	SHC		
31000	75	1181	952	1317	739	1462	519	1121	915	1253	706	1392	486	1059	877	1184	672	1316	453
	80	1195	1123	1322	917	1465	698	1136	1089	1257	884	1395	666	1075	1054	1189	850	1321	632
	85	1234	1234	1328	1092	1469	877	1183	1183	1264	1056	1400	845	1128	1128	1197	1020	1325	811
	90	1304	1304	1342	1265	1473	1055	1252	1252	1280	1232	1404	1023	1196	1196	1215	1198	1330	990
35000	75	1210	1012	1346	779	1489	529	1147	976	1278	745	1415	496	1082	939	1206	709	1336	461
	80	1228	1211	1351	980	1493	732	1168	1168	1283	946	1420	699	1106	1106	1211	911	1342	664
	85	1287	1287	1360	1171	1497	934	1233	1233	1294	1137	1424	901	1175	1175	1223	1101	1347	866
	90	1362	1362	1376	1362	1502	1135	1306	1306	1314	1309	1429	1102	1246	1246	1249	1249	1352	1068
39000	75	1233	1075	1368	817	1509	539	1169	1039	1298	782	1433	505	1101	1001	1222	746	1351	469
	80	1259	1259	1374	1041	1514	765	1200	1200	1304	1007	1438	731	1139	1139	1229	966	1357	696
	85	1334	1334	1387	1253	1519	989	1276	1276	1318	1217	1443	956	1214	1214	1245	1180	1362	921
	90	1411	1411	1414	1414	1525	1208	1352	1352	1354	1354	1450	1174	1288	1288	1290	1290	1370	1131
43000	75	1254	1138	1387	855	1526	549	1187	1101	1313	820	1447	514	1117	1062	1236	782	1363	477
	80	1293	1293	1393	1097	1532	797	1233	1233	1321	1054	1453	763	1170	1170	1244	1016	1369	727
	85	1374	1374	1410	1334	1536	1045	1312	1312	1339	1297	1458	1011	1247	1247	1265	1259	1375	975
	90	1453	1453	1455	1455	1544	1277	1390	1390	1392	1392	1467	1241	1323	1323	1325	1325	1385	1204
44000	75	1258	1154	1391	865	1530	551	1191	1116	1317	829	1450	516	1121	1077	1239	791	1365	479
	80	1301	1301	1398	1112	1535	805	1241	1241	1325	1069	1456	771	1177	1177	1248	1030	1372	734
	85	1383	1383	1415	1354	1540	1059	1321	1321	1344	1317	1462	1024	1255	1255	1265	1251	1378	988
	90	1463	1463	1465	1465	1548	1296	1399	1399	1401	1401	1470	1260	1331	1331	1332	1332	1388	1222
46000	75	1267	1185	1398	884	1536	556	1199	1147	1323	847	1456	520	1128	1107	1244	809	1370	483
	80	1317	1317	1406	1134	1542	822	1256	1256	1332	1097	1462	786	1190	1190	1254	1057	1377	750
	85	1400	1400	1426	1394	1547	1086	1337	1337	1348	1330	1467	1051	1269	1269	1271	1271	1383	1015
	90	1480	1480	1482	1482	1556	1333	1415	1415	1417	1417	1477	1296	1345	1345	1347	1347	1394	1258
CFM	Ent DB (°F)	Ambient Temperature (°F)																	
		115																	
		Entering Wet Bulb (°F)																	
		61		67		73		61		67		73		61		67		73	
CAP	SHC	CAP	SHC	CAP	SHC	CAP	SHC	CAP	SHC	CAP	SHC	CAP	SHC	CAP	SHC	CAP	SHC		
31000	75	992	840	1110	636	1235	417												
	80	1011	1010	1115	814	1241	597												
	85	1070	1070	1125	984	1246	776												
	90	1136	1136	1145	1145	1251	955												
35000	75	1012	901	1128	672	1252	425												
	80	1043	1043	1135	874	1258	628												
	85	1112	1112	1148	1063	1264	830												
	90	1182	1182	1184	1184	1270	1027												
39000	75	1029	961	1142	708	1264	432												
	80	1075	1075	1150	921	1271	659												
	85	1147	1147	1168	1141	1277	884												
	90	1220	1220	1222	1222	1286	1093												
43000	75	1042	1021	1153	743	1273	439												
	80	1102	1102	1163	975	1281	689												
	85	1177	1177	1184	1184	1287	937												
	90	1250	1250	1252	1252	1298	1164												
44000	75	1046	1036	1155	752	1275	441												
	80	1108	1108	1166	989	1283	696												
	85	1184	1184	1186	1186	1289	944												
	90	1257	1257	1259	1259	1300	1182												
46000	75	1052	1052	1159	770	1279	445												
	80	1120	1120	1171	1016	1287	712												
	85	1196	1196	1198	1198	1293	969												
	90	1270	1270	1271	1271	1305	1218												



**Performance Data**

**Table 46. Gross cooling capacities (MBh) — 115 ton air-cooled —standard efficiency**

CFM	Ent DB (°F)	Ambient Temperature (°F)																	
		85						95						105					
		Entering Wet Bulb (°F)																	
		61		67		73		61		67		73		61		67		73	
CAP	SHC	CAP	SHC	CAP	SHC	CAP	SHC	CAP	SHC	CAP	SHC	CAP	SHC	CAP	SHC	CAP	SHC		
31000	75	1247	982	1390	769	1537	546	1185	944	1323	735	1465	513	1119	908	1250	699	1386	477
	80	1260	1154	1394	947	1541	725	1199	1118	1327	913	1468	692	1134	1082	1255	877	1391	657
	85	1292	1292	1401	1122	1544	903	1239	1239	1335	1088	1472	870	1182	1182	1264	1052	1395	836
	90	1364	1364	1414	1296	1548	1081	1311	1311	1349	1261	1476	1048	1253	1253	1279	1225	1400	1014
35000	75	1279	1047	1421	809	1565	556	1214	1007	1350	773	1489	522	1145	968	1275	736	1408	486
	80	1296	1243	1426	1010	1569	758	1233	1207	1356	975	1494	724	1167	1150	1280	938	1413	689
	85	1350	1350	1435	1207	1573	959	1294	1294	1366	1167	1498	926	1233	1233	1292	1129	1418	890
	90	1427	1427	1449	1397	1577	1160	1369	1369	1385	1351	1503	1126	1307	1307	1317	1303	1423	1087
39000	75	1305	1108	1446	848	1587	566	1238	1070	1372	811	1508	531	1166	1030	1293	773	1424	494
	80	1330	1310	1452	1071	1591	791	1267	1264	1378	1031	1513	756	1200	1200	1300	993	1430	719
	85	1401	1401	1464	1284	1595	1014	1340	1340	1392	1247	1517	980	1276	1276	1316	1208	1434	944
	90	1479	1479	1491	1475	1600	1233	1417	1417	1420	1420	1523	1198	1351	1351	1354	1354	1441	1161
43000	75	1328	1171	1466	885	1604	575	1258	1132	1389	848	1523	539	1184	1091	1308	809	1436	502
	80	1363	1363	1472	1127	1609	822	1299	1299	1397	1089	1528	787	1233	1233	1317	1044	1442	750
	85	1443	1443	1488	1364	1612	1069	1380	1380	1414	1327	1532	1034	1312	1312	1336	1287	1447	997
	90	1523	1523	1525	1525	1619	1308	1458	1458	1460	1460	1540	1266	1388	1388	1390	1390	1455	1227
44000	75	1333	1187	1470	895	1608	577	1263	1148	1393	857	1527	541	1188	1106	1311	818	1439	504
	80	1371	1371	1477	1141	1613	830	1308	1308	1401	1104	1532	795	1241	1241	1321	1058	1445	758
	85	1453	1453	1494	1384	1616	1083	1389	1389	1419	1347	1536	1048	1320	1320	1341	1307	1450	1005
	90	1533	1533	1535	1535	1623	1320	1467	1467	1469	1469	1543	1284	1396	1396	1398	1398	1458	1245
46000	75	1343	1218	1478	913	1615	581	1271	1178	1400	876	1533	545	1196	1137	1317	836	1444	508
	80	1388	1388	1486	1171	1620	846	1324	1324	1409	1126	1538	810	1255	1255	1327	1086	1450	773
	85	1471	1471	1504	1424	1623	1110	1406	1406	1429	1386	1542	1075	1335	1335	1349	1321	1455	1030
	90	1551	1551	1553	1553	1631	1357	1484	1484	1486	1486	1550	1320	1411	1411	1413	1413	1464	1281
CFM	Ent DB (°F)	Ambient Temperature (°F)																	
		115																	
		Entering Wet Bulb (°F)																	
		61		67		73		61		67		73		61		67		73	
CAP	SHC	CAP	SHC	CAP	SHC	CAP	SHC	CAP	SHC	CAP	SHC	CAP	SHC	CAP	SHC	CAP	SHC		
31000	75	1049	866	1173	661	1302	440												
	80	1066	1043	1179	839	1308	620												
	85	1122	1122	1188	1010	1312	799												
	90	1190	1190	1205	1175	1317	977												
35000	75	1071	928	1194	697	1321	448												
	80	1099	1099	1200	895	1327	651												
	85	1168	1168	1213	1089	1331	853												
	90	1240	1240	1242	1242	1338	1049												
39000	75	1090	988	1209	733	1334	456												
	80	1132	1132	1218	952	1341	681												
	85	1207	1207	1235	1168	1345	906												
	90	1280	1280	1282	1282	1353	1116												
43000	75	1105	1048	1221	769	1344	463												
	80	1162	1162	1232	1002	1351	711												
	85	1239	1239	1253	1232	1355	952												
	90	1313	1313	1315	1315	1365	1187												
44000	75	1109	1063	1224	777	1346	464												
	80	1169	1169	1235	1015	1353	719												
	85	1246	1246	1258	1238	1358	965												
	90	1320	1320	1322	1322	1368	1204												
46000	75	1116	1092	1228	795	1350	468												
	80	1182	1182	1241	1042	1357	734												
	85	1260	1260	1268	1265	1362	990												
	90	1333	1333	1334	1334	1372	1239												

**Table 47. Gross cooling capacities (MBh) — 130 ton air-cooled —standard efficiency**

CFM	Ent DB (°F)	Ambient Temperature (°F)																	
		85						95						105					
		Entering Wet Bulb (°F)																	
		61		67		73		61		67		73		61		67		73	
		CAP	SHC	CAP	SHC	CAP	SHC	CAP	SHC	CAP	SHC	CAP	SHC	CAP	SHC	CAP	SHC	CAP	SHC
31000	75	1356	1031	1496	811	1637	579	1292	995	1428	775	1552	539	1223	957	1353	738	1465	500
	80	1364	1205	1499	988	1639	757	1302	1168	1430	952	1554	718	1234	1130	1356	915	1467	679
	85	1383	1380	1502	1164	1642	935	1324	1324	1434	1129	1557	896	1265	1265	1361	1092	1469	856
	90	1446	1446	1511	1336	1645	1113	1391	1391	1443	1300	1560	1073	1331	1331	1370	1262	1471	1033
35000	75	1389	1099	1526	848	1669	589	1323	1062	1454	812	1579	548	1251	1021	1376	773	1485	507
	80	1402	1294	1528	1048	1672	791	1337	1256	1457	1011	1582	750	1266	1216	1379	973	1488	709
	85	1437	1437	1534	1247	1675	992	1379	1379	1463	1209	1585	951	1316	1316	1385	1166	1491	910
	90	1507	1507	1545	1439	1679	1192	1447	1447	1475	1402	1589	1152	1381	1381	1399	1363	1495	1110
39000	75	1417	1163	1549	884	1694	599	1348	1121	1474	847	1600	557	1273	1080	1393	808	1502	514
	80	1434	1381	1552	1107	1698	824	1366	1342	1477	1070	1603	782	1294	1293	1396	1030	1505	739
	85	1487	1487	1560	1322	1702	1048	1425	1425	1484	1283	1607	1006	1357	1357	1404	1243	1508	963
	90	1557	1557	1577	1543	1707	1272	1490	1490	1500	1498	1612	1230	1419	1419	1421	1421	1514	1187
43000	75	1440	1223	1569	921	1715	609	1368	1183	1489	882	1616	565	1291	1140	1405	842	1514	522
	80	1461	1461	1573	1166	1719	857	1392	1392	1492	1127	1621	814	1321	1321	1409	1083	1518	770
	85	1527	1527	1584	1402	1723	1104	1461	1461	1502	1360	1625	1061	1389	1389	1419	1319	1522	1017
	90	1603	1603	1606	1606	1730	1351	1528	1528	1530	1530	1632	1302	1450	1450	1451	1451	1530	1252
44000	75	1445	1238	1573	930	1719	611	1373	1198	1492	891	1620	568	1295	1156	1407	850	1517	524
	80	1468	1468	1577	1181	1724	865	1398	1398	1495	1142	1624	822	1329	1329	1411	1097	1521	778
	85	1536	1536	1590	1422	1728	1118	1469	1469	1506	1380	1629	1074	1396	1396	1422	1337	1525	1030
	90	1614	1614	1617	1617	1735	1370	1538	1538	1540	1540	1636	1321	1457	1457	1459	1459	1534	1270
46000	75	1454	1269	1581	948	1728	616	1381	1228	1498	908	1627	572	1302	1185	1412	867	1522	527
	80	1479	1479	1587	1212	1733	881	1414	1414	1502	1166	1631	837	1342	1342	1416	1119	1527	793
	85	1554	1554	1601	1462	1737	1146	1484	1484	1514	1418	1636	1102	1409	1409	1427	1375	1531	1057
	90	1635	1635	1638	1638	1745	1404	1556	1556	1558	1558	1644	1353	1472	1472	1474	1474	1540	1306
CFM	Ent DB (°F)	Ambient Temperature (°F)																	
		115																	
		Entering Wet Bulb (°F)																	
		61		67		73		61		67		73		61		67		73	
		CAP	SHC	CAP	SHC	CAP	SHC	CAP	SHC	CAP	SHC	CAP	SHC	CAP	SHC	CAP	SHC	CAP	SHC
31000	75	1150	917	1272	698	1374	460												
	80	1162	1089	1275	875	1376	639												
	85	1201	1201	1280	1053	1378	816												
	90	1264	1264	1291	1222	1380	993												
35000	75	1174	975	1291	732	1389	466												
	80	1191	1174	1294	932	1391	667												
	85	1247	1247	1302	1124	1392	867												
	90	1309	1309	1316	1300	1397	1068												
39000	75	1193	1036	1305	766	1399	471												
	80	1217	1217	1308	989	1403	696												
	85	1283	1283	1317	1200	1405	920												
	90	1341	1341	1342	1342	1412	1139												
43000	75	1208	1096	1314	799	1409	478												
	80	1247	1247	1318	1035	1412	725												
	85	1311	1311	1329	1275	1416	972												
	90	1365	1365	1367	1367	1424	1205												
44000	75	1211	1110	1316	808	1411	479												
	80	1253	1253	1321	1048	1414	733												
	85	1316	1316	1332	1293	1418	986												
	90	1371	1371	1372	1372	1427	1223												
46000	75	1218	1140	1319	824	1414	482												
	80	1265	1265	1324	1074	1418	748												
	85	1327	1327	1337	1329	1422	1012												
	90	1379	1379	1385	1385	1432	1259												



Performance Data

# Heating Performance

Table 48. Natural gas heating capacities, 20 to 75 tons

Nominal Tons	MBh (Input)	MBh (Output)	Air Temperature Rise vs Unit CFM											
			CFM											
			4000	5000	6000	6250	7000	8000	9000	10000	10650	11000	11500	12000
20	235	190.35	43.9											
	500	405												
25	235	190.35		35.1	29.2	28.1	25.1	21.9	19.5					
	500	405				59.7	53.3	46.7	41.5	17.5	16.5	15.9		
30	350	283.5			43.5	41.8	37.3	32.7	29.0	26.1	24.6	23.8	22.7	21.8
	500	405					53.3	46.7	41.5	37.3	35.1	33.9	32.5	31.1
40	350	283.5						32.7	29.0	26.1	24.6	23.8	22.7	21.8
	850	688.5									59.7	57.7	55.2	52.9
50-55	500	405								37.3	35.1	33.9	32.5	31.1
	850	688.5											55.2	52.9
60-75	500	405												
	850	688.5												

Nominal Tons	MBh (Input)	MBh (Output)	Air Temperature Rise vs Unit CFM											
			CFM											
			13500	14000	17000	18000	19500	21000	22500	24000	25500	27000	28500	30000
20	235	190.35												
	500	405												
25	235	190.35												
	500	405												
30	350	283.5	19.4											
	500	405	27.6											
40	350	283.5	19.4	18.7	15.4									
	850	688.5	47.0	45.3	37.3	35.3								
50-55	500	405	27.6	26.7	22.0	20.7	19.1	17.8	16.6					
	850	688.5	47.0	45.3	37.3	35.3	32.5	30.2	28.2					
60-75	500	405		26.7	22.0	20.7	19.1	17.8	16.6	15.6				
	850	688.5		45.3	37.3	35.3	32.5	30.2	28.2	26.4	24.9	23.5	22.3	21.2

Notes:

1. All heaters are 81% efficient.
2. Air temperature rise at sea level = heat output (Btu) ÷ (CFM x 1.085).
3. CFM values below the minimum and above the maximum shown in this table are not cULus approved.

Table 49. Natural gas heating capacities, 90 to 130 tons

Nominal Tons	MBh (Input)	MBh (Output)	Air Temperature Rise vs Unit CFM								
			CFM								
			28350	30250	32550	34750	37000	39250	41500	43000	46000
90 to 130	1000	810	26.3	24.7	22.9	21.5	20.2	19.0	18.0	17.4	16.2

Notes:

1. All heaters are 81% efficient.
2. CFM values below the minimums and above the maximums shown in this table are not cULus approved.
3. Air Temperature Rise at sea level = Heat Output (Btu) ÷ (CFM x 1.085).



**Table 50. Steam heating capacities (Q/ITD)**

20 Nominal Ton Unit					25 Nominal Ton Unit					30 Nominal Ton Unit				
Steam Module	Unit Standard Air Volume (CFM)				Steam Module	Unit Standard Air Volume (CFM)				Steam Module	Unit Standard Air Volume (CFM)			
	4000	6000	8000	10000		5000	7500	10000	12500		6000	9000	12000	15000
Low Heat	0.95	1.18	1.37	1.52	Low Heat	1.06	1.33	1.52	1.74	Low Heat	1.18	1.64	1.69	2
High Heat	1.94	2.47	2.95	3.31	High Heat	2.2	2.85	3.31	3.65	High Heat	2.47	3.12	3.59	3.95
40 Nominal Ton Unit					50/55 Nominal Ton Unit					60 Nominal Ton Unit				
Steam Module	Unit Standard Air Volume (CFM)				Steam Module	Unit Standard Air Volume (CFM)				Steam Module	Unit Standard Air Volume (CFM)			
	8000	12000	16000	20000		10000	15000	20000	25000		12000	18000	24000	30000
Low Heat	1.61	2.01	2.29	2.6	Low Heat	1.82	2.21	2.6	2.85	Low Heat	2.32	2.81	3.33	3.71
High Heat	3.36	4.28	4.93	5.43	High Heat	3.86	4.79	5.43	5.97	High Heat	3.85	4.84	5.62	6.18
70-75 Nominal Ton Unit					90, 105, 115, 130 Nominal Ton Unit									
Steam Module	Unit Standard Air Volume (CFM)				Steam Module	Unit Standard Air Volume (CFM)								
	16000	20000	24000	30000		27000	33000	40000	46000					
Low Heat	2.65	2.98	3.33	3.71	Low Heat	5.17	5.7	6.19	6.53					
High Heat	4.5	5.1	5.62	6.18	High Heat	8.83	8.8	9.04	9.26					

**Note:** Capacities expressed as MBh (Q) per initial temperature difference (ITD) between the entering air temperature to the steam module and the entering steam temperature. Maximum recommended operating pressure is 35 PSIG.

**Table 51. Properties of steam**

Steam Pressure (Psig)	2	5	10	15	20	25	30	40	50
Temperature Of Steam (°F)	219	227	239	250	259	267	274	287	298



## Performance Data

**Table 52. Electric heat air temperature rise — 20 to 75 tons**

kW Input	Total MBh	CFM											
		4000	6000	8000	10000	12000	14000	16000	18000	20000	22000	24000	26000
30	102.4	23.6	15.7	11.8	9.4	7.9	6.7	5.9	5.2	4.7	4.3	3.9	3.6
50	170.6	39.3	26.2	19.7	15.7	13.1	11.2	9.8	8.7	7.9	7.1	6.6	6.0
70	238.8		36.7	27.5	22	18.3	15.7	13.8	12.2	11	10	9.2	8.5
90	307.1		47.2	35.4	28.3	23.6	20.2	17.7	15.7	14.2	12.9	11.8	10.9
110	375.3			43.2	34.6	28.8	24.7	21.6	19.2	17.3	15.7	14.4	13.3
130	443.6				40.9	34.1	29.2	25.6	22.7	20.4	18.6	17	15.7
150	511.8				47.2	39.3	33.7	29.5	26.2	23.6	21.4	19.7	18.1
170	580.1					44.6	38.2	33.4	29.7	26.7	24.3	22.3	20.6
190	648.3					49.8	42.7	37.3	33.2	29.9	27.2	24.9	23

**Notes:**

1. Maximum permitted air temperature rise; 20-50 tons (cULus - 50°F), 60 - 75 tons (cULus - 43°F).
2. Air temperature rise at sea level = kW x 3413 ÷ (scfm x 1.085)
3. All heaters on units provide 3 increments of capacity.
4. See Electrical Data for electrical sizing information.
5. 200 and 230 volt electric heat rooftops require dual power supplies to the control box. All other rooftops have single power connections.

**Table 53. Electric heat air temperature rise — 90 to 130 tons**

kW Input	Total MBh	CFM					
		24000	27000	30000	33000	36000	40000
190	648.3	24.9	22.1	19.9	18.1	16.5	15.3

**Notes:**

1. Air temperature at sea level = kW x 3413 ÷ (scfm x 1.085)
2. Only available in 460/60/3 and 575/60/3 voltages.

**Table 54. Electric heat kW ranges**

Nominal Tons	Nominal Voltage			
	200	230	460	575
20	30-90	30-110	30-110	30-110
25	30-90	30-110	30-130	30-130
30	30-110	30-110	30-150	30-150
40	50-110	50-110	50-170	50-170
50-55	70-110	70-110	70-190	70-190
60	90-110	90-110	90-190	90-190
70	90-110	90-110	90-190	90-190
75	90-110	90-110	90-190	90-190
90	N/A	N/A	190	190
105	N/A	N/A	190	190
115	N/A	N/A	190	190
130	N/A	N/A	190	190

**Table 55. Hot water heating capacities (Q/ITD)**

20, 25, 30 Nominal Tons								
Hot Water Module	Gpm	Water PD (ft)	Unit Standard Air Volume (CFM)					
			4000	6000	8000	10000	12000	14000
Low	10	0.54	1.65	1.99	2.21	2.37	2.48	2.56
High	20	0.91	2.23	2.78	3.16	3.44	3.67	3.85
Low	20	0.91	1.88	2.35	2.69	2.94	3.12	3.27
High	30	1.49	2.36	3	3.46	3.81	4.09	4.31
Low	30	1.49	1.97	2.51	2.9	3.19	3.42	3.6
High	40	2.25	2.43	3.12	3.63	4.02	4.34	4.6
Low	40	2.25	2.02	2.6	3.02	3.34	3.6	3.79
High	50	3.2	2.48	3.2	3.74	4.17	4.51	4.8
Low	60	4.31	2.08	2.69	3.16	3.51	3.79	4.02
High	70	5.65	2.54	3.3	3.88	4.35	4.73	5.04
40, 50 to 55 Nominal Tons								
Hot Water Module	Gpm	Water PD (ft)	Unit Standard Air Volume (CFM)					
			8000	11000	14000	17000	20000	23000
Low	20	0.7	3	3.44	3.75	3.98	4.14	4.29
High	30	1.05	3.85	4.46	4.91	5.26	5.54	5.76
Low	40	1.51	3.4	4	4.43	4.76	5.02	5.21
High	50	2.1	4.2	4.95	5.52	5.97	6.34	6.64
Low	60	2.78	3.56	4.23	4.73	5.11	5.4	5.63
High	75	4.04	4.39	5.24	5.89	6.41	6.85	7.21
Low	80	4.5	3.65	4.36	4.89	5.31	5.63	5.88
High	90	5.54	4.46	5.34	6.03	6.58	7.04	7.42
Low	100	6.66	3.71	4.44	5	5.43	5.77	6.04
High	125	9.99	4.56	5.5	6.23	6.83	7.33	7.75
60, 70, 75 Nominal Tons								
Hot Water Module	Gpm	Water PD (Ft)	Unit Standard Air Volume (CFM)					
			12000	16000	20000	24000	28000	31500
Low	25	0.98	4.28	4.82	5.2	5.48	5.69	5.83
High	30	1.22	5.24	5.91	6.4	6.77	7.06	7.27
Low	50	2.48	4.9	5.63	6.18	6.6	6.92	7.15
High	60	3.33	6.01	6.94	7.66	8.22	8.69	9.03
Low	75	4.83	5.14	5.97	6.6	7.09	7.46	7.73
High	90	6.65	6.32	7.38	8.2	8.87	9.42	9.83
Low	100	8	5.28	6.16	6.84	7.36	7.78	8.07
High	120	11.15	6.49	7.62	8.51	9.23	9.84	10.3
Low	125	11.99	5.37	6.29	6.99	7.54	7.98	8.29
High	150	16.8	6.6	7.77	8.71	9.47	10.11	10.6
90, 105, 115, 130 Nominal Tons								
Hot Water Module	Gpm	Water PD (Ft)	Unit Standard Air Volume (CFM)					
			27000	30000	33000	36000	39000	42000
Low	30	0.77	6.68	6.87	7.04	7.18	7.3	7.41
High	40	1.02	8.51	8.8	9.04	9.26	9.45	9.62
Low	60	1.69	8.07	8.38	8.64	8.87	9.07	9.25
High	80	2.6	10.21	10.64	11.03	11.38	11.69	11.98
Low	100	3.71	8.82	9.19	9.52	9.8	10.05	10.26
High	120	5.07	10.95	11.46	11.92	12.33	12.71	13.05
Low	140	6.59	9.19	9.6	9.96	10.27	10.55	10.79
High	160	8.37	11.37	11.93	12.43	12.88	13.3	13.67
Low	175	9.8	9.39	9.82	10.2	10.53	10.82	11.07
High	200	12.52	11.64	12.23	12.76	13.24	13.68	14.08

**Note:** Capacities expressed as MBh per initial temperature difference (ITD) between the entering air temperature to the hot water coil and the entering water temperature. Ethylene glycol or other capacities can be determined from the Trane® heating coil computer program. Capacity and pressure drop of ethylene glycol vary greatly with temperature and concentration.



# Supply Fan Performance

Figure 8. Supply fan performance 20 and 25 tons - forward curved

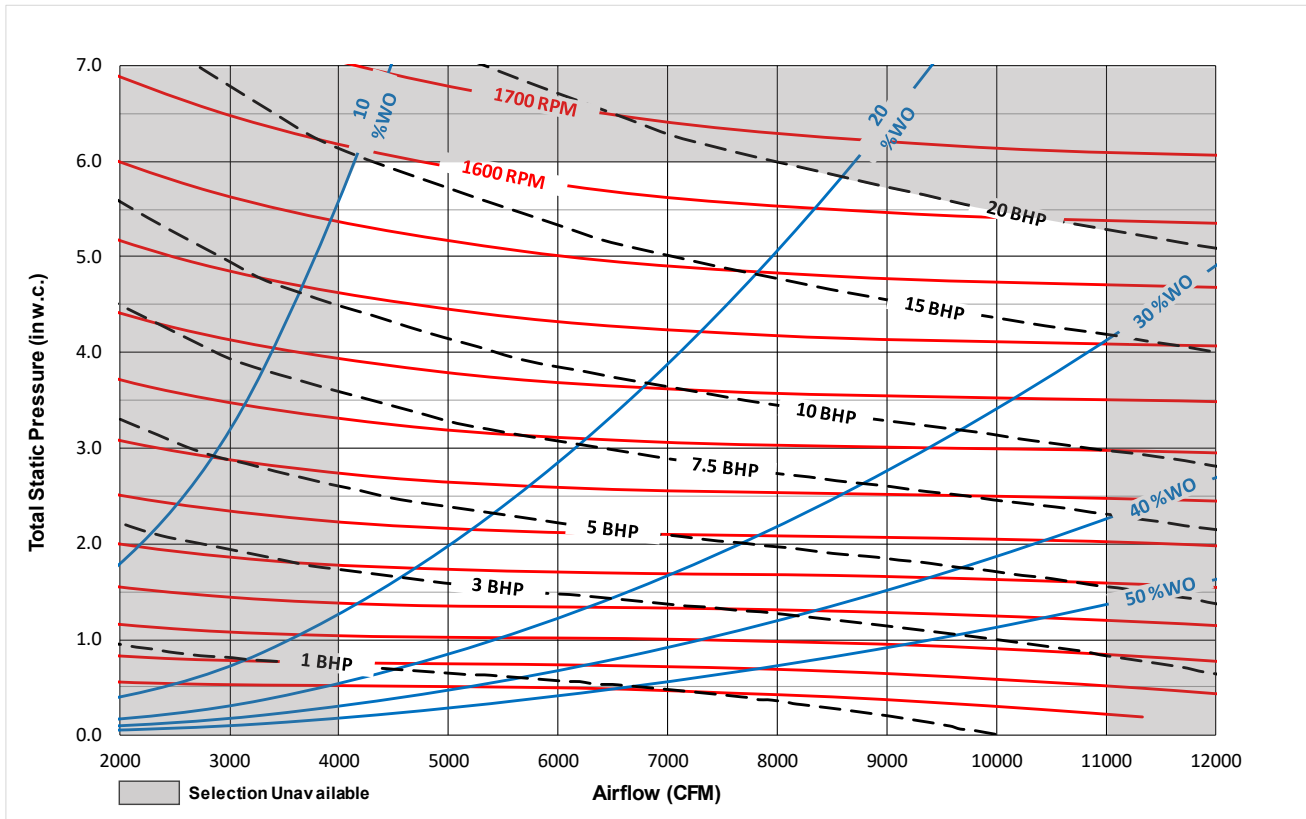

**Notes:**

- Supply fan performance curve includes internal resistance of rooftop. For total static pressure determination, system external static must be added to appropriate component (evaporator coil, filters, etc.) static pressure drops.
- Static pressure drops from the supply fan to the space (optional heat + curb + supply ESP) cannot exceed 4.0 in w.c.
- Curve can show combined operating min/max for multiple tonnages. Refer to general data for appropriate operating parameters such as motor horsepower and airflow ranges.
- Shaded areas represent unavailable selections. Contact your local Trane representative for more information on selections in these shaded regions.
- Max RPM is indicated on curve and RPM values are in increments of 100RPM unless otherwise shown.
- Catalog curves represent fan data corrected to the following standard conditions: 70°F dry bulb temperature, barometric pressure of 14.696 psia, and an air density of 0.075 lb/ft<sup>3</sup>. Use Trane Select Assist to generate fan curves for unit-specific operating temperatures and elevations.

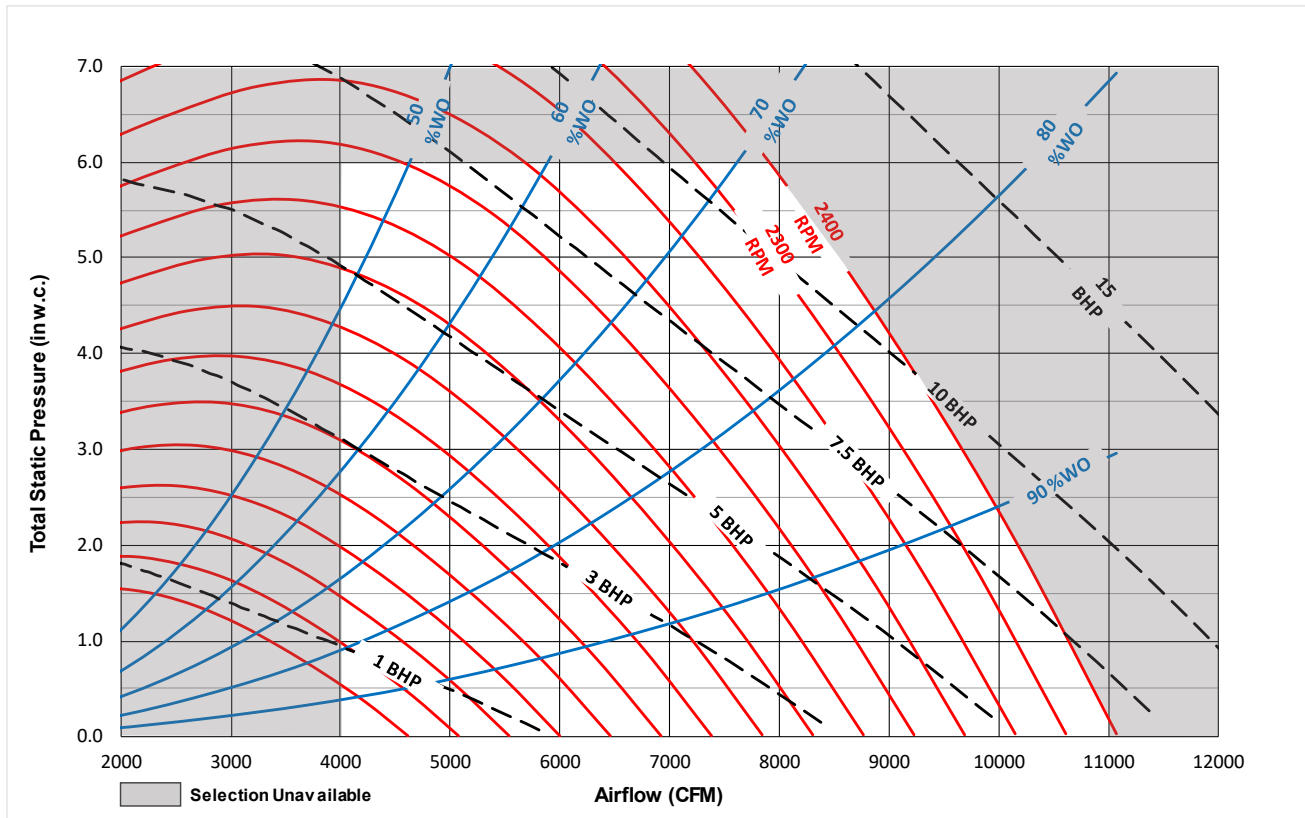
**Figure 9. Supply fan performance - 20 and 25 tons cooling only - direct drive plenum, 80% width**

**Notes:**

- Supply fan performance curve includes internal resistance of rooftop. For total static pressure determination, system external static must be added to appropriate component (evaporator coil, filters, etc.) static pressure drops.
- Static pressure drops from the supply fan to the space (optional heat + curb + supply ESP) cannot exceed 4.0 in w.c.
- Curve can show combined operating min/max for multiple tonnages. Refer to general data for appropriate operating parameters such as motor horsepower and airflow ranges.
- Shaded areas represent unavailable selections. Contact your local Trane representative for more information on selections in these shaded regions.
- Max RPM is indicated on curve and RPM values are in increments of 100RPM unless otherwise shown.
- Catalog curves represent fan data corrected to the following standard conditions: 70°F dry bulb temperature, barometric pressure of 14.696 psia, and an air density of 0.075 lb/ft<sup>3</sup>. Use Trane Select Assist to generate fan curves for unit-specific operating temperatures and elevations.

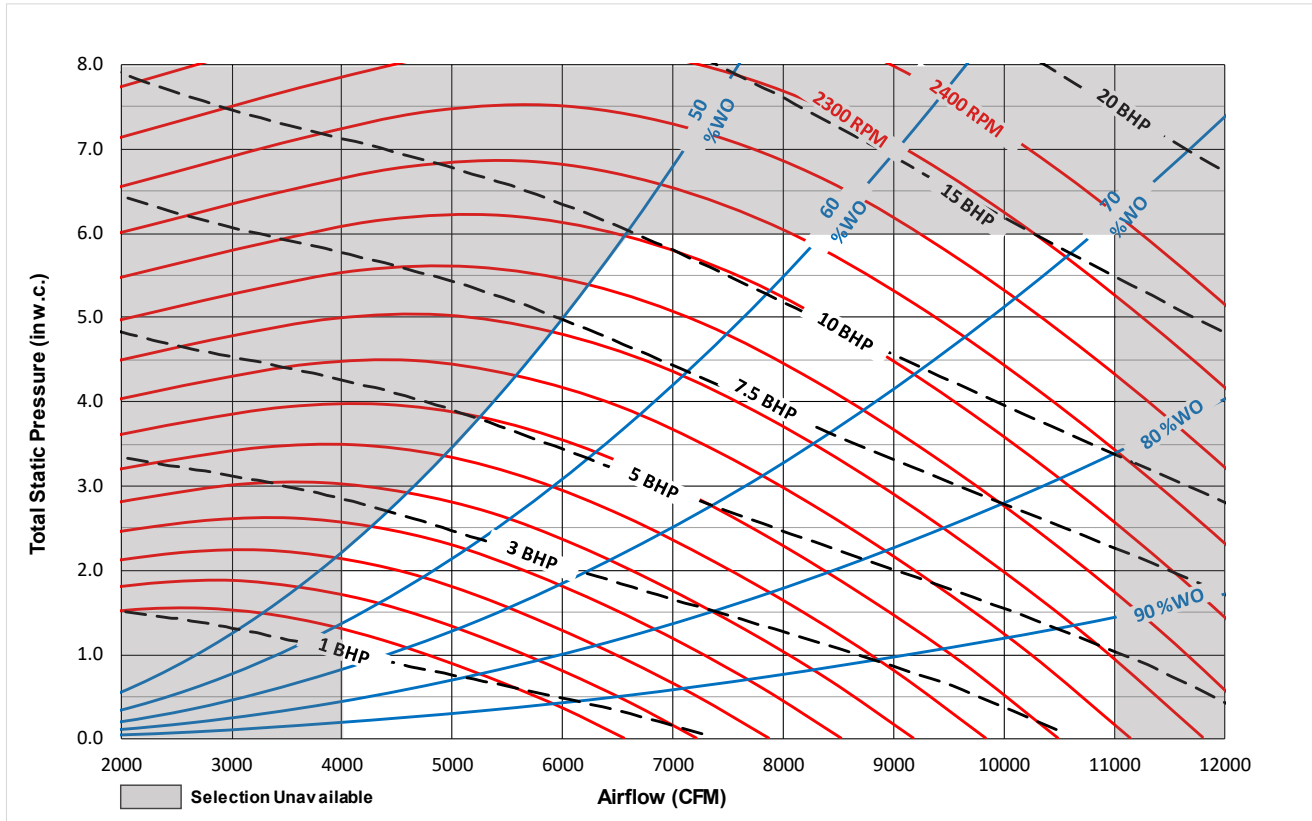

## Performance Data

Figure 10. Supply fan performance - 20 and 25 tons cooling only - direct drive plenum, 120% width



### Notes:

- Supply fan performance curve includes internal resistance of rooftop. For total static pressure determination, system external static must be added to appropriate component (evaporator coil, filters, etc.) static pressure drops.
- Static pressure drops from the supply fan to the space (optional heat + curb + supply ESP) cannot exceed 4.0 in w.c.
- Curve can show combined operating min/max for multiple tonnages. Refer to general data for appropriate operating parameters such as motor horsepower and airflow ranges.
- Shaded areas represent unavailable selections. Contact your local Trane representative for more information on selections in these shaded regions.
- Max RPM is indicated on curve and RPM values are in increments of 100RPM unless otherwise shown.
- Catalog curves represent fan data corrected to the following standard conditions: 70°F dry bulb temperature, barometric pressure of 14.696 psia, and an air density of 0.075 lb/ft<sup>3</sup>. Use Trane Select Assist to generate fan curves for unit-specific operating temperatures and elevations.

Figure 11. Supply fan performance - 30 ton - forward curved

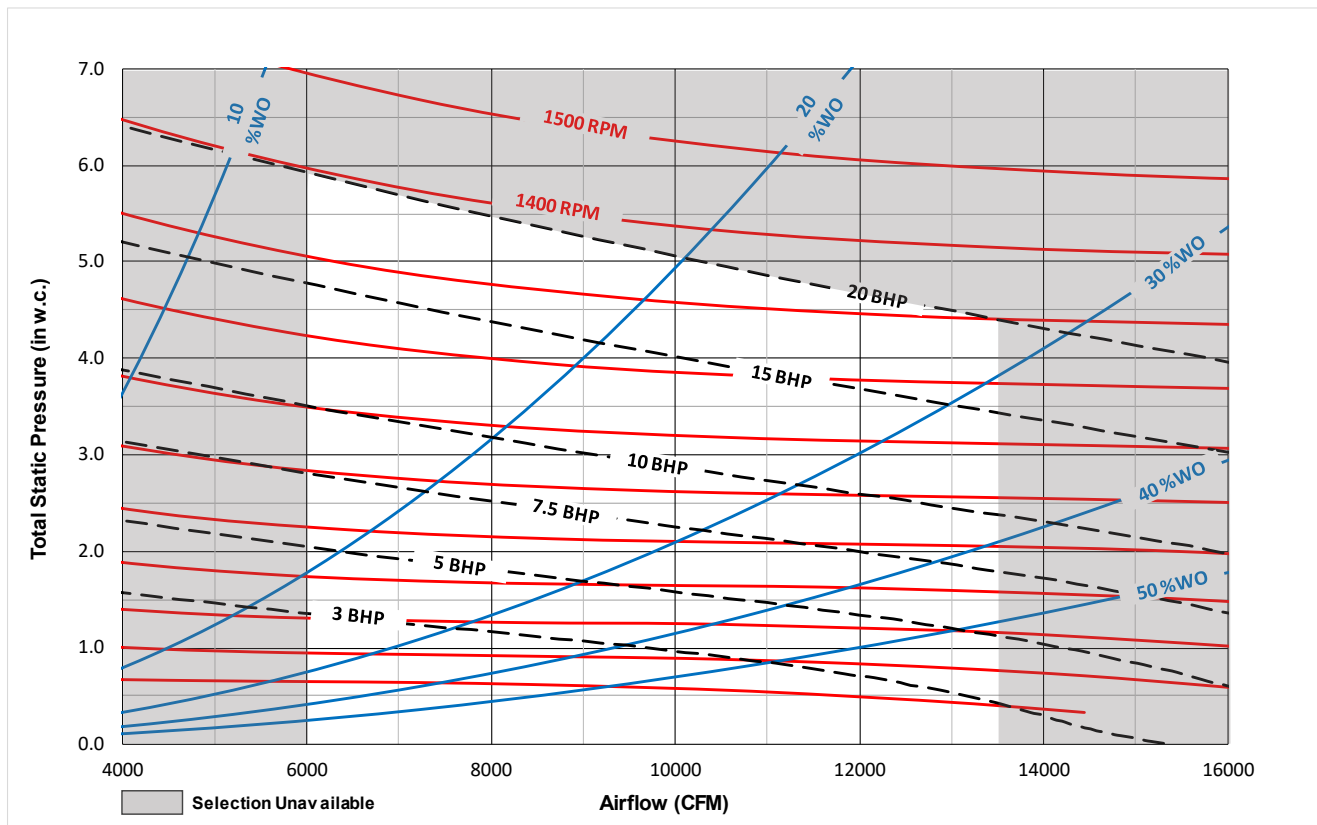

**Notes:**

- Supply fan performance curve includes internal resistance of rooftop. For total static pressure determination, system external static must be added to appropriate component (evaporator coil, filters, etc.) static pressure drops.
- Static pressure drops from the supply fan to the space (optional heat + curb + supply ESP) cannot exceed 4.0 in w.c.
- Curve can show combined operating min/max for multiple tonnages. Refer to general data for appropriate operating parameters such as motor horsepower and airflow ranges.
- Shaded areas represent unavailable selections. Contact your local Trane representative for more information on selections in these shaded regions.
- Max RPM is indicated on curve and RPM values are in increments of 100RPM unless otherwise shown.
- Catalog curves represent fan data corrected to the following standard conditions: 70°F dry bulb temperature, barometric pressure of 14.696 psia, and an air density of 0.075 lb/ft<sup>3</sup>. Use Trane Select Assist to generate fan curves for unit-specific operating temperatures and elevations.



## Performance Data

Figure 12. Supply fan performance - 30 ton cooling only, 20/25 ton gas heat- direct drive plenum, 80% width

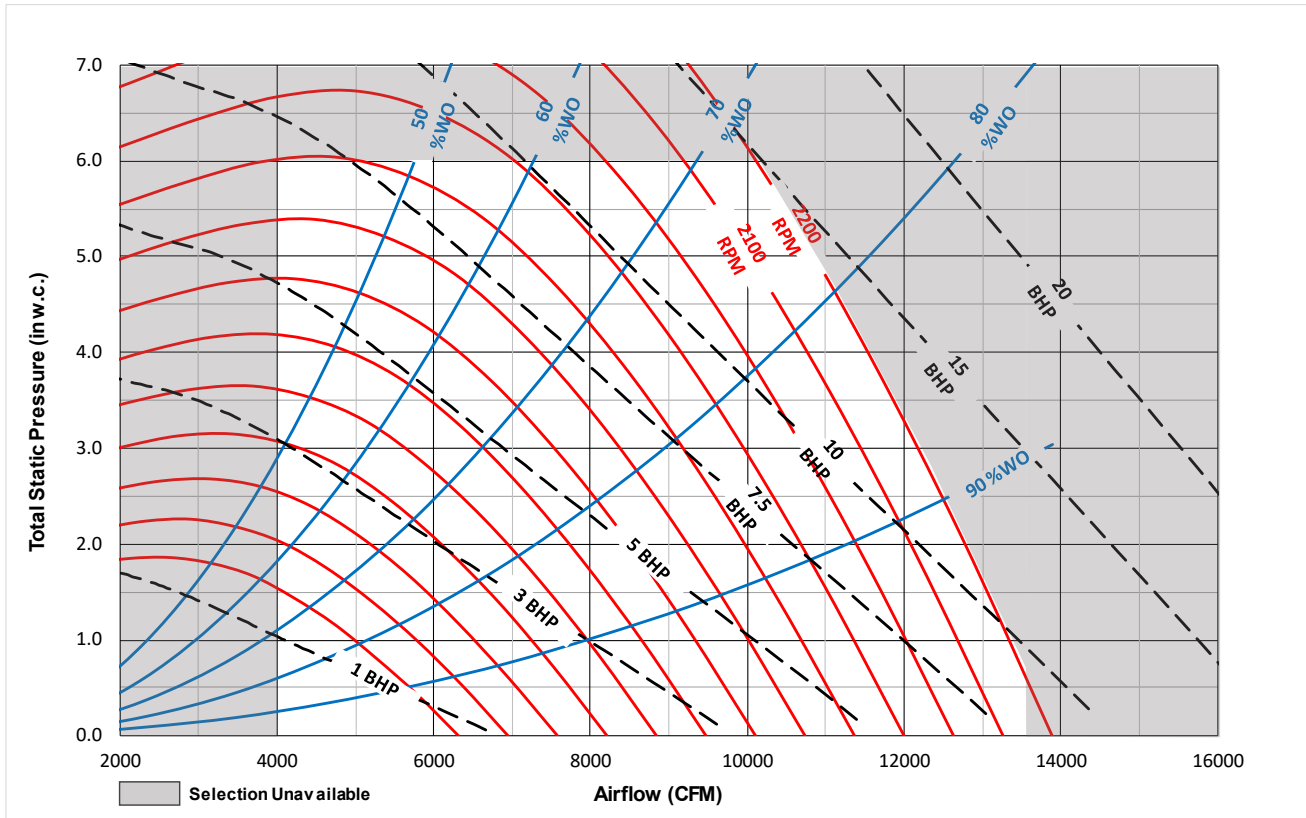

### Notes:

- Supply fan performance curve includes internal resistance of rooftop. For total static pressure determination, system external static must be added to appropriate component (evaporator coil, filters, etc.) static pressure drops.
- Static pressure drops from the supply fan to the space (optional heat + curb + supply ESP) cannot exceed 4.0 in w.c.
- Curve can show combined operating min/max for multiple tonnages. Refer to general data for appropriate operating parameters such as motor horsepower and airflow ranges.
- Shaded areas represent unavailable selections. Contact your local Trane representative for more information on selections in these shaded regions.
- Max RPM is indicated on curve and RPM values are in increments of 100RPM unless otherwise shown.
- Catalog curves represent fan data corrected to the following standard conditions: 70°F dry bulb temperature, barometric pressure of 14.696 psia, and an air density of 0.075 lb/ft<sup>3</sup>. Use Trane Select Assist to generate fan curves for unit-specific operating temperatures and elevations.

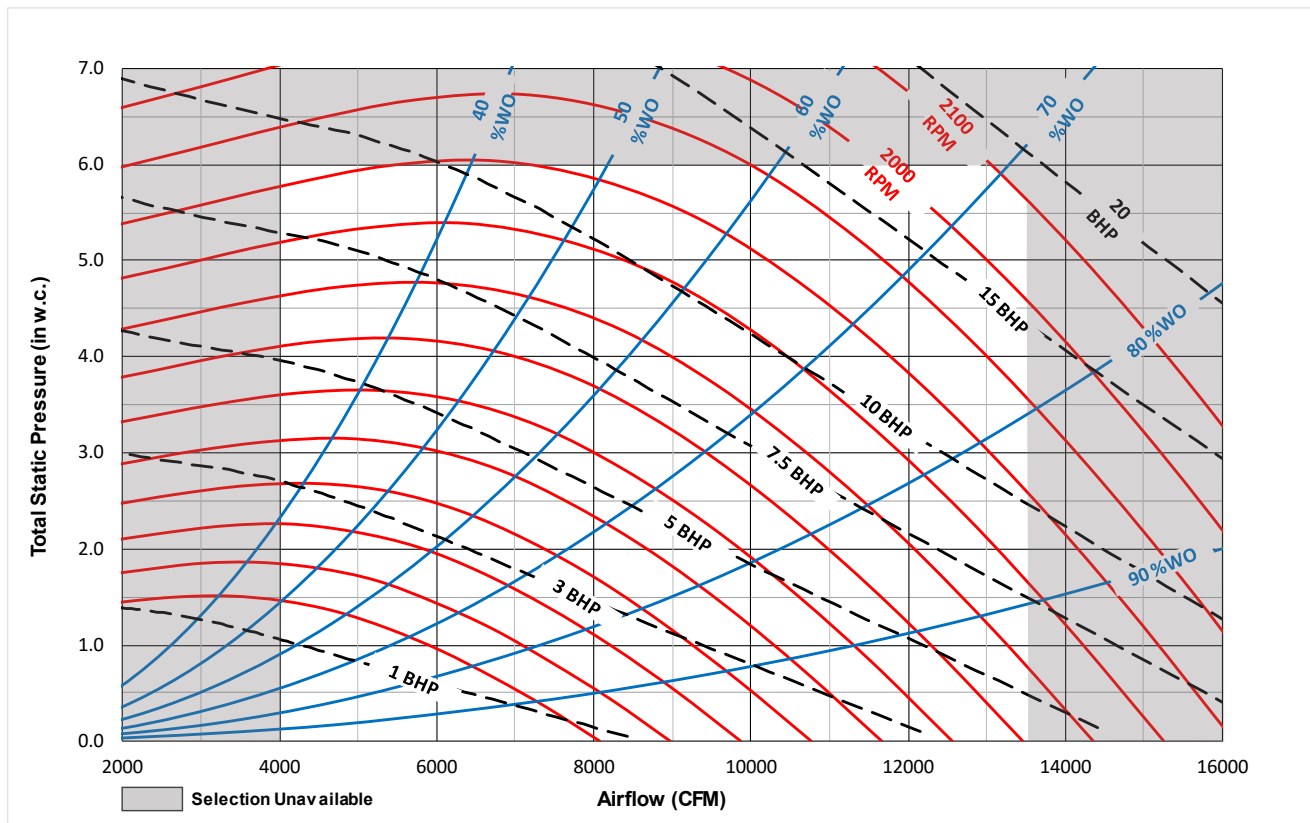

**Figure 13. Supply fan performance - 30 ton cooling only, 20/25 ton gas heat- direct drive plenum, 120% width**

**Notes:**

- Supply fan performance curve includes internal resistance of rooftop. For total static pressure determination, system external static must be added to appropriate component (evaporator coil, filters, etc.) static pressure drops.
- Static pressure drops from the supply fan to the space (optional heat + curb + supply ESP) cannot exceed 4.0 in w.c.
- Curve can show combined operating min/max for multiple tonnages. Refer to general data for appropriate operating parameters such as motor horsepower and airflow ranges.
- Shaded areas represent unavailable selections. Contact your local Trane representative for more information on selections in these shaded regions.
- Max RPM is indicated on curve and RPM values are in increments of 100RPM unless otherwise shown.
- Catalog curves represent fan data corrected to the following standard conditions: 70°F dry bulb temperature, barometric pressure of 14.696 psia, and an air density of 0.075 lb/ft<sup>3</sup>. Use Trane Select Assist to generate fan curves for unit-specific operating temperatures and elevations.

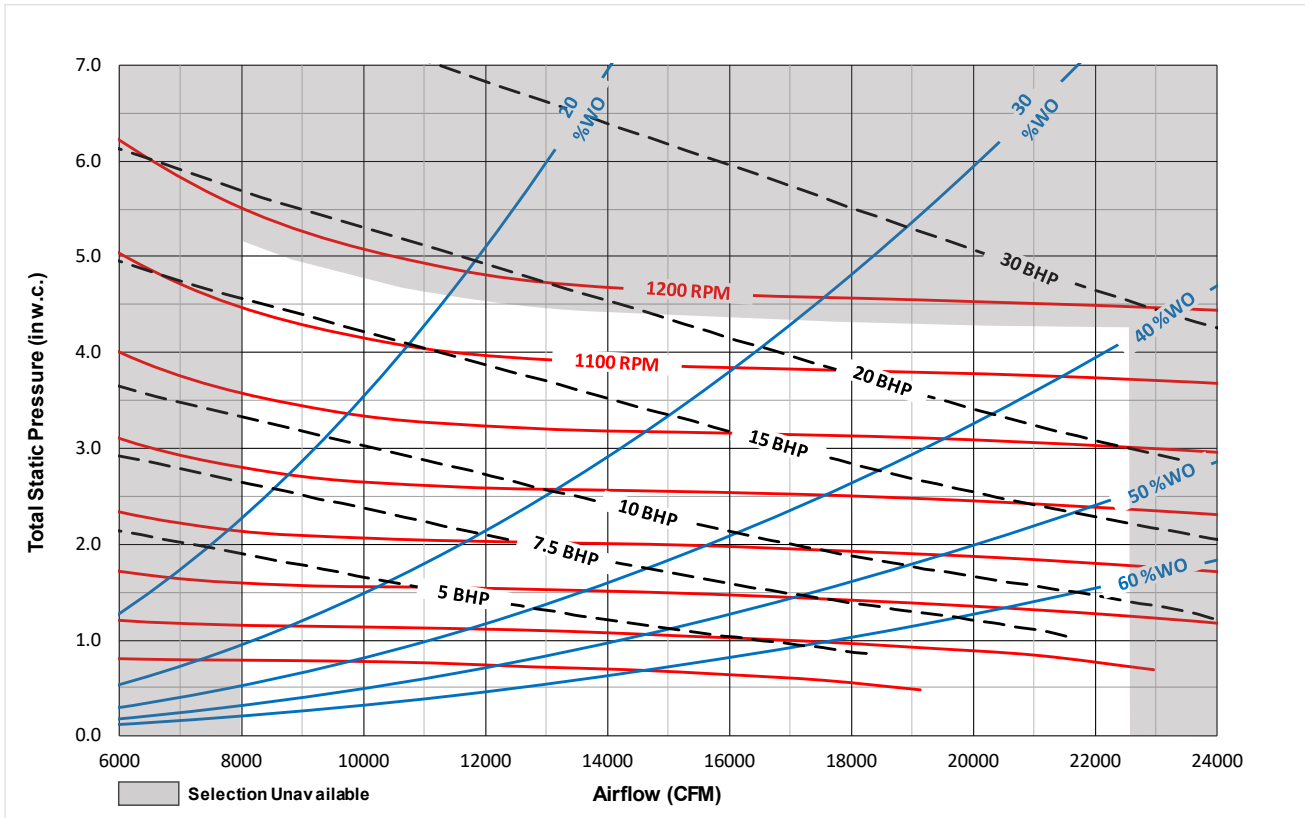

## Performance Data

Figure 14. Supply fan performance - 40, 50, and 55 tons - forward curved



### Notes:

- Supply fan performance curve includes internal resistance of rooftop. For total static pressure determination, system external static must be added to appropriate component (evaporator coil, filters, etc.) static pressure drops.
- Static pressure drops from the supply fan to the space (optional heat + curb + supply ESP) cannot exceed 4.0 in w.c.
- Curve can show combined operating min/max for multiple tonnages. Refer to general data for appropriate operating parameters such as motor horsepower and airflow ranges.
- Shaded areas represent unavailable selections. Contact your local Trane representative for more information on selections in these shaded regions.
- Max RPM is indicated on curve and RPM values are in increments of 100RPM unless otherwise shown.
- Catalog curves represent fan data corrected to the following standard conditions: 70°F dry bulb temperature, barometric pressure of 14.696 psia, and an air density of 0.075 lb/ft<sup>3</sup>. Use Trane Select Assist to generate fan curves for unit-specific operating temperatures and elevations.

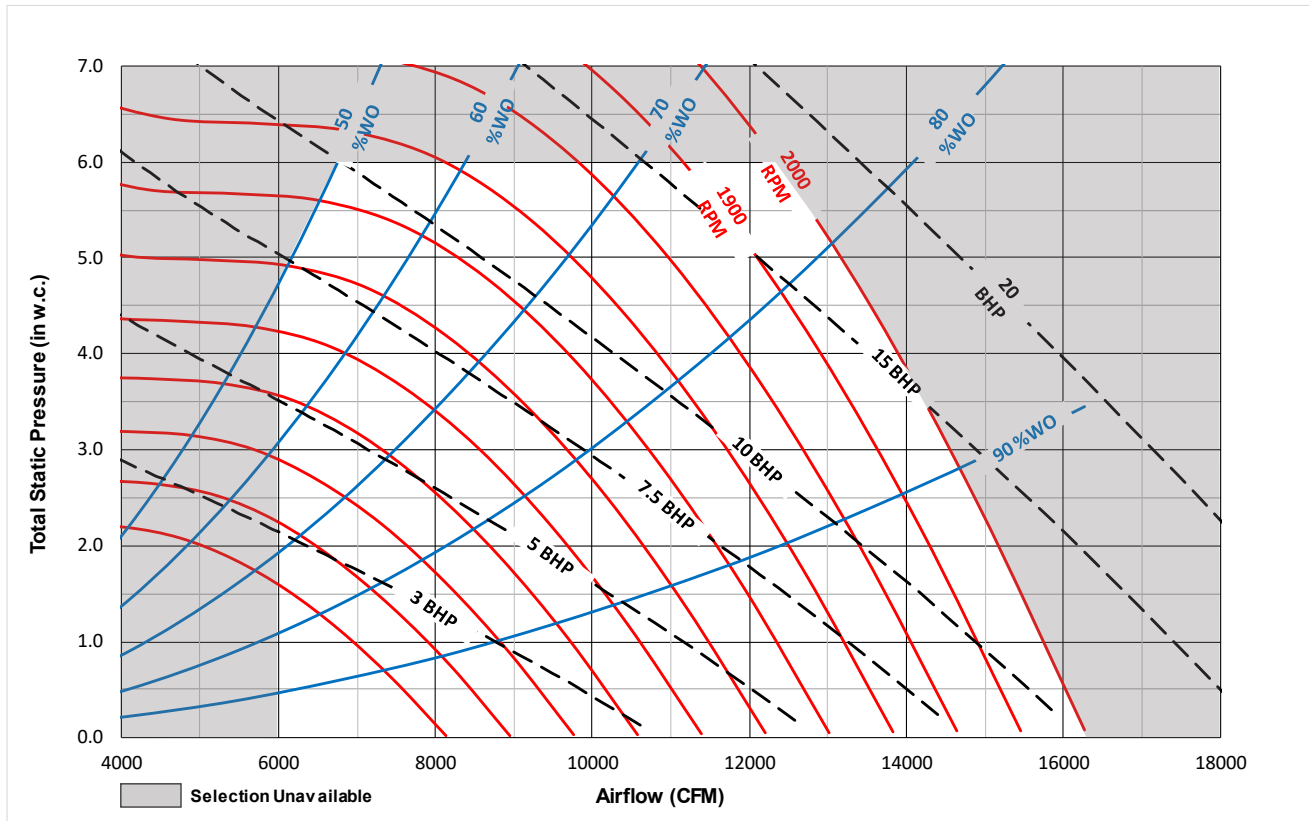
**Figure 15. Supply fan performance - 40 ton cooling only, 30 ton gas heat - direct drive plenum, 80% width**

**Notes:**

- Supply fan performance curve includes internal resistance of rooftop. For total static pressure determination, system external static must be added to appropriate component (evaporator coil, filters, etc.) static pressure drops.
- Static pressure drops from the supply fan to the space (optional heat + curb + supply ESP) cannot exceed 4.0 in w.c.
- Curve can show combined operating min/max for multiple tonnages. Refer to general data for appropriate operating parameters such as motor horsepower and airflow ranges.
- Shaded areas represent unavailable selections. Contact your local Trane representative for more information on selections in these shaded regions.
- Max RPM is indicated on curve and RPM values are in increments of 100RPM unless otherwise shown.
- Catalog curves represent fan data corrected to the following standard conditions: 70°F dry bulb temperature, barometric pressure of 14.696 psia, and an air density of 0.075 lb/ft<sup>3</sup>. Use Trane Select Assist to generate fan curves for unit-specific operating temperatures and elevations.

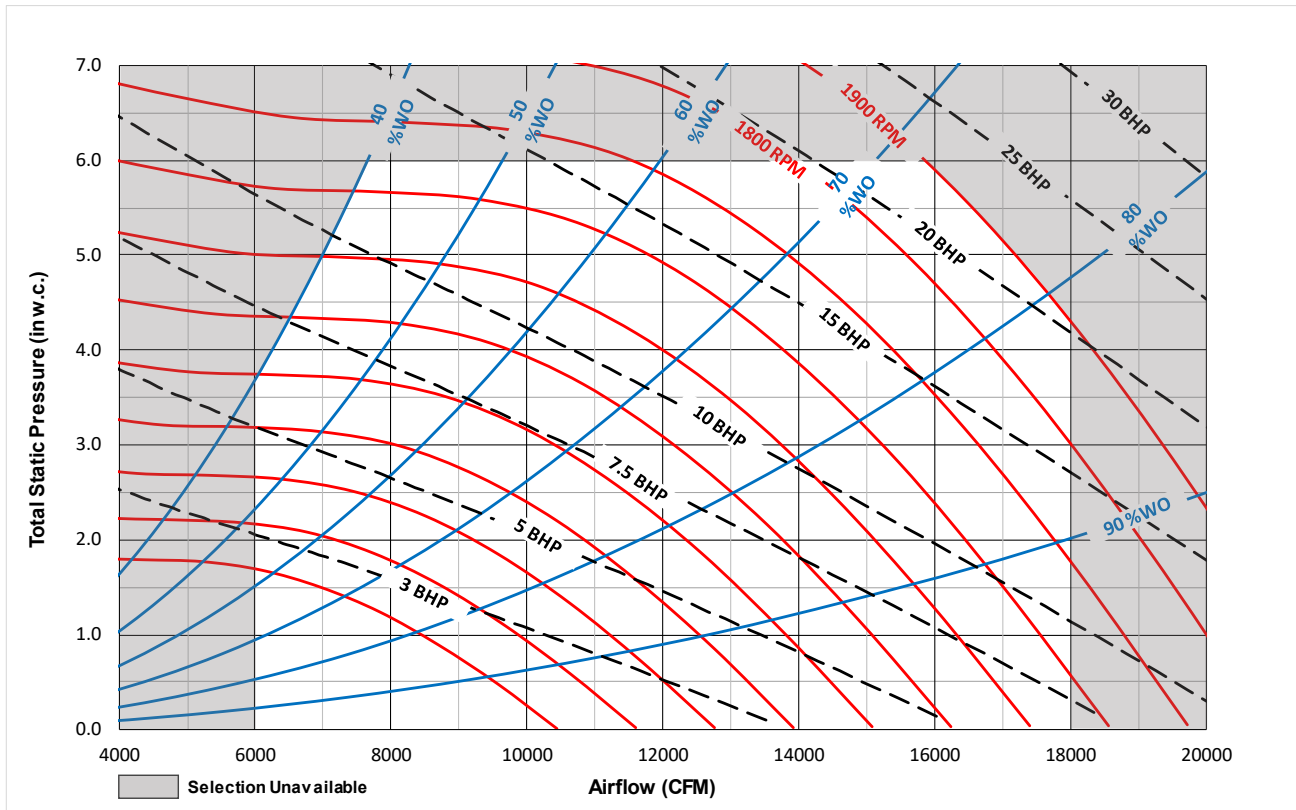

## Performance Data

Figure 16. Supply fan performance - 40 ton cooling only - direct drive plenum, 120% width



### Notes:

- Supply fan performance curve includes internal resistance of rooftop. For total static pressure determination, system external static must be added to appropriate component (evaporator coil, filters, etc.) static pressure drops.
- Static pressure drops from the supply fan to the space (optional heat + curb + supply ESP) cannot exceed 4.0 in w.c.
- Curve can show combined operating min/max for multiple tonnages. Refer to general data for appropriate operating parameters such as motor horsepower and airflow ranges.
- Shaded areas represent unavailable selections. Contact your local Trane representative for more information on selections in these shaded regions.
- Max RPM is indicated on curve and RPM values are in increments of 100RPM unless otherwise shown.
- Catalog curves represent fan data corrected to the following standard conditions: 70°F dry bulb temperature, barometric pressure of 14.696 psia, and an air density of 0.075 lb/ft<sup>3</sup>. Use Trane Select Assist to generate fan curves for unit-specific operating temperatures and elevations.

Figure 17. Supply fan performance - 50, 55 tons, 40 ton gas heat - direct drive plenum, 80% width

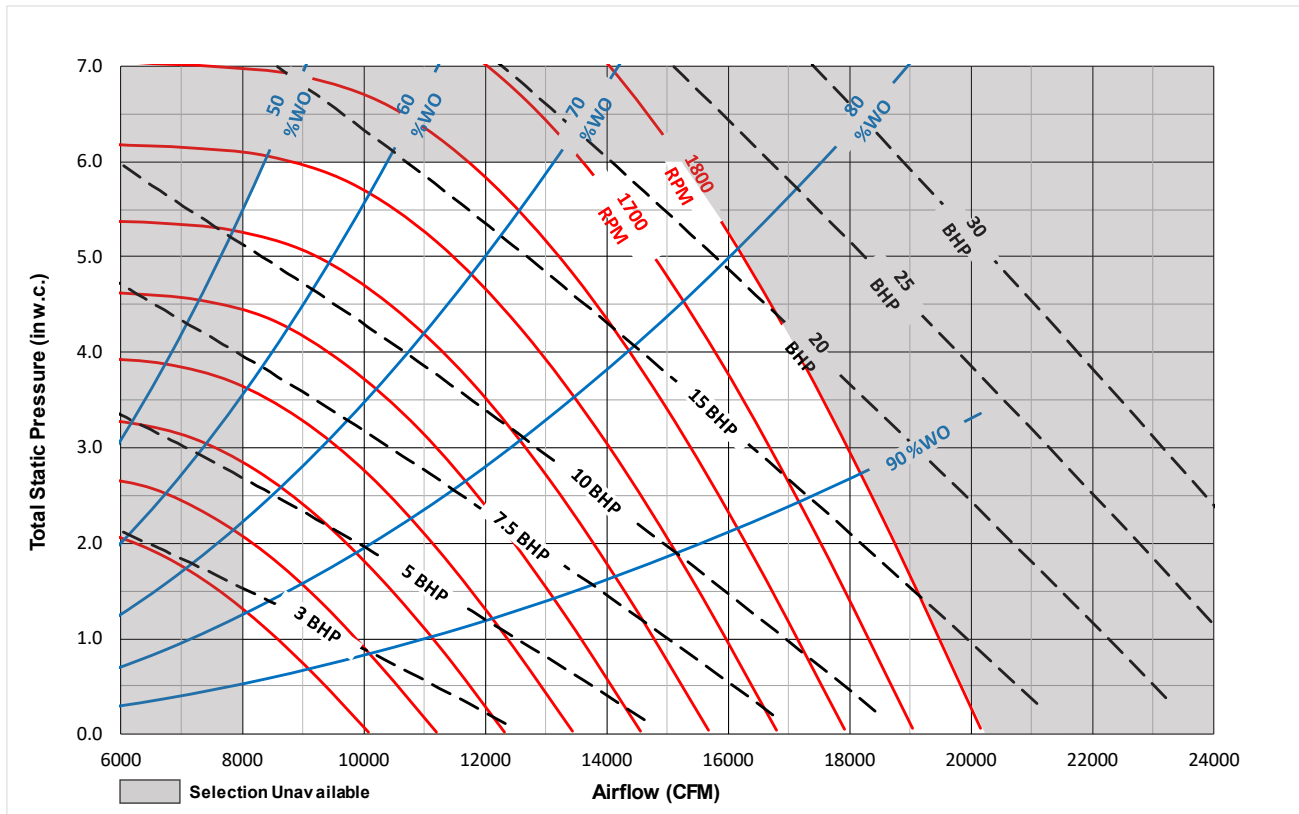

**Notes:**

- Supply fan performance curve includes internal resistance of rooftop. For total static pressure determination, system external static must be added to appropriate component (evaporator coil, filters, etc.) static pressure drops.
- Static pressure drops from the supply fan to the space (optional heat + curb + supply ESP) cannot exceed 4.0 in w.c.
- Curve can show combined operating min/max for multiple tonnages. Refer to general data for appropriate operating parameters such as motor horsepower and airflow ranges.
- Shaded areas represent unavailable selections. Contact your local Trane representative for more information on selections in these shaded regions.
- Max RPM is indicated on curve and RPM values are in increments of 100RPM unless otherwise shown.
- Catalog curves represent fan data corrected to the following standard conditions: 70°F dry bulb temperature, barometric pressure of 14.696 psia, and an air density of 0.075 lb/ft<sup>3</sup>. Use Trane Select Assist to generate fan curves for unit-specific operating temperatures and elevations.



## Performance Data

Figure 18. Supply fan performance - 50, 55 tons, 40 ton gas heat - direct drive plenum, 100% width

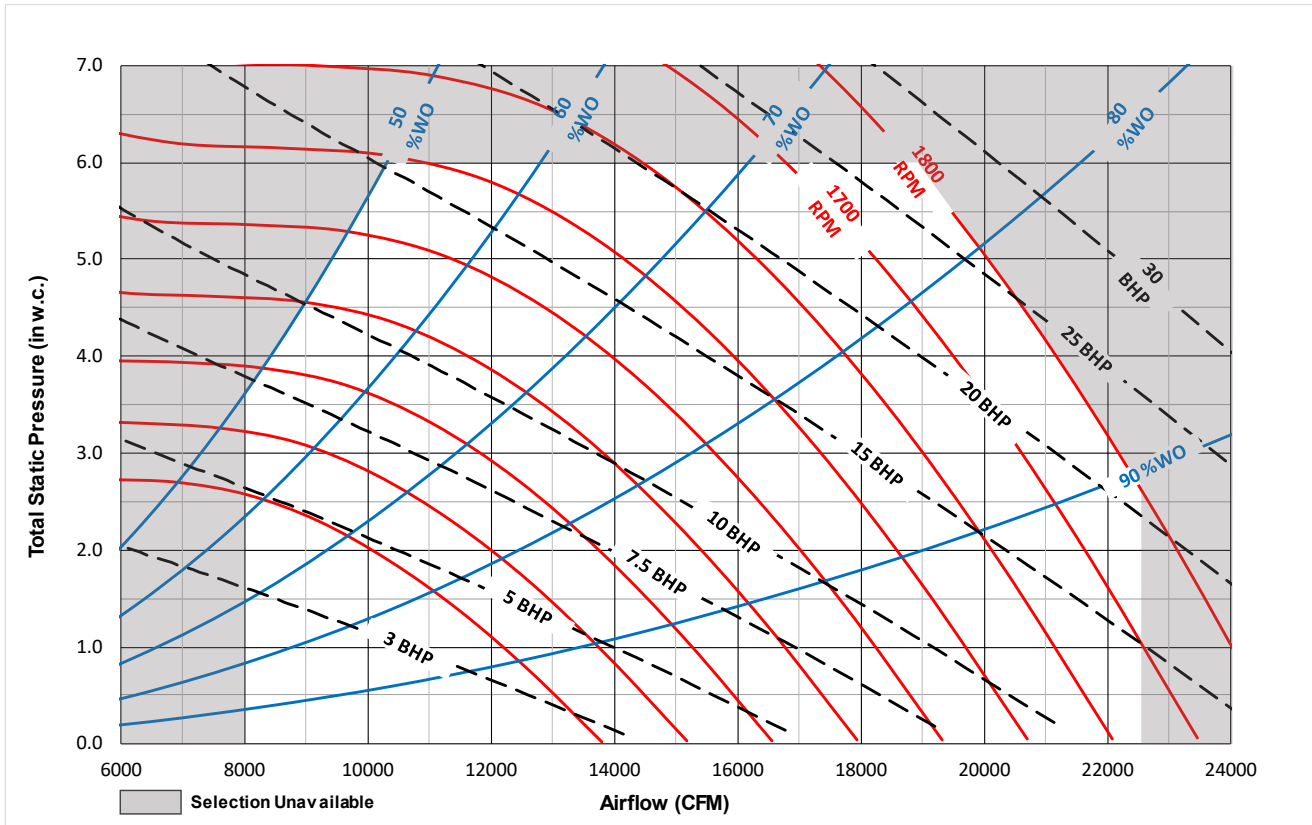

### Notes:

- Supply fan performance curve includes internal resistance of rooftop. For total static pressure determination, system external static must be added to appropriate component (evaporator coil, filters, etc.) static pressure drops.
- Static pressure drops from the supply fan to the space (optional heat + curb + supply ESP) cannot exceed 4.0 in w.c.
- Curve can show combined operating min/max for multiple tonnages. Refer to general data for appropriate operating parameters such as motor horsepower and airflow ranges.
- Shaded areas represent unavailable selections. Contact your local Trane representative for more information on selections in these shaded regions.
- Max RPM is indicated on curve and RPM values are in increments of 100RPM unless otherwise shown.
- Catalog curves represent fan data corrected to the following standard conditions: 70°F dry bulb temperature, barometric pressure of 14.696 psia, and an air density of 0.075 lb/ft<sup>3</sup>. Use Trane Select Assist to generate fan curves for unit-specific operating temperatures and elevations.

Figure 19. Supply fan performance - 50, 55 tons, 40 ton gas heat - direct drive plenum, 120% width

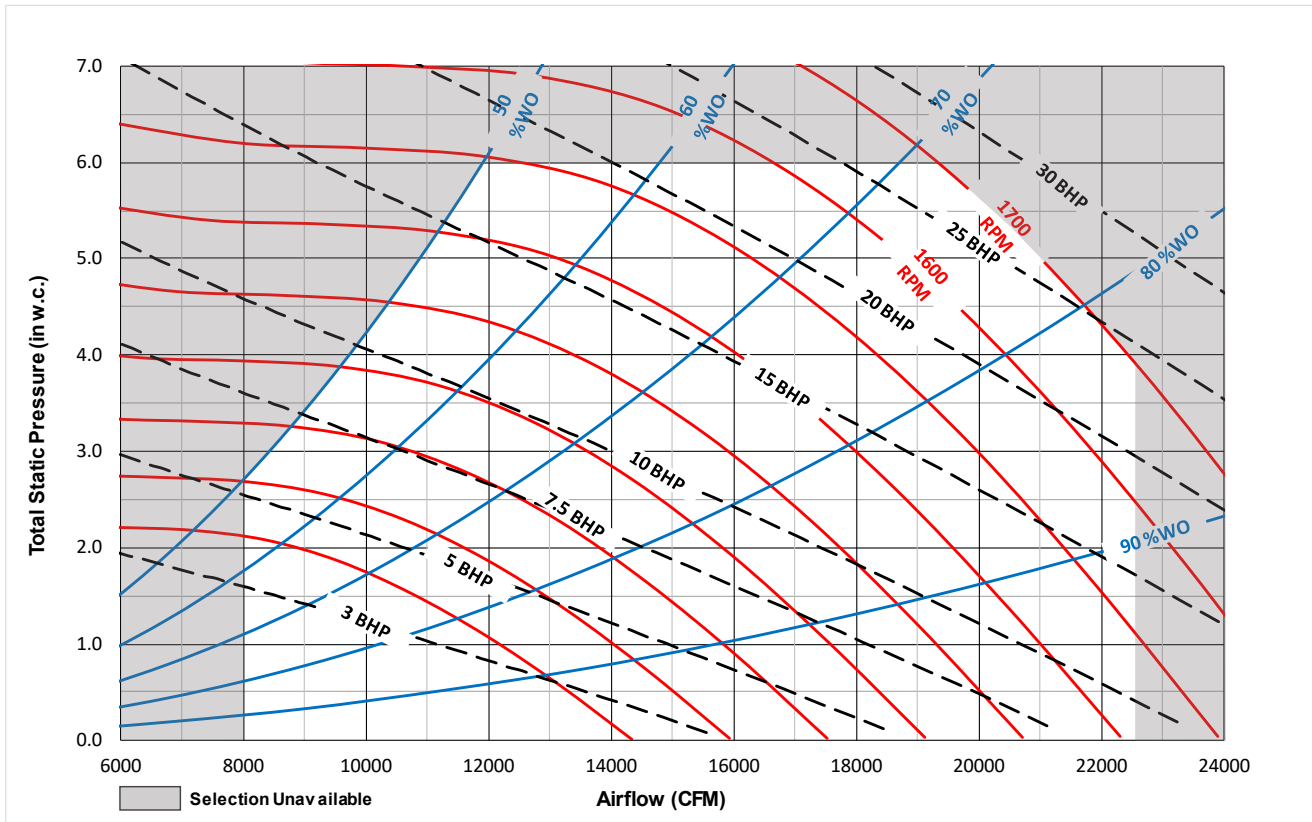

**Notes:**

- Supply fan performance curve includes internal resistance of rooftop. For total static pressure determination, system external static must be added to appropriate component (evaporator coil, filters, etc.) static pressure drops.
- Static pressure drops from the supply fan to the space (optional heat + curb + supply ESP) cannot exceed 4.0 in w.c.
- Curve can show combined operating min/max for multiple tonnages. Refer to general data for appropriate operating parameters such as motor horsepower and airflow ranges.
- Shaded areas represent unavailable selections. Contact your local Trane representative for more information on selections in these shaded regions.
- Max RPM is indicated on curve and RPM values are in increments of 100RPM unless otherwise shown.
- Catalog curves represent fan data corrected to the following standard conditions: 70°F dry bulb temperature, barometric pressure of 14.696 psia, and an air density of 0.075 lb/ft<sup>3</sup>. Use Trane Select Assist to generate fan curves for unit-specific operating temperatures and elevations.



## Performance Data

Figure 20. Supply fan performance - 60, 70, and 75 tons - forward curved

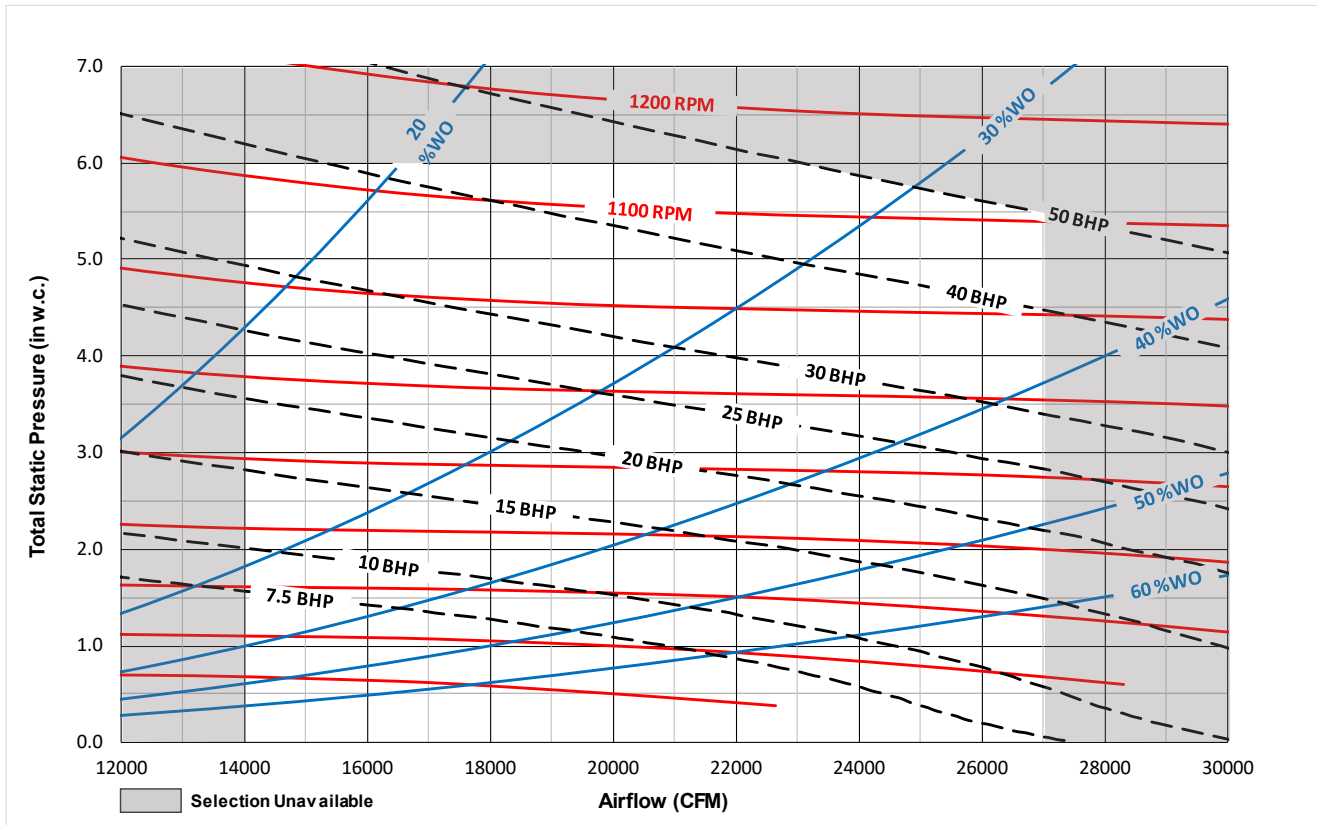

### Notes:

- Supply fan performance curve includes internal resistance of rooftop. For total static pressure determination, system external static must be added to appropriate component (evaporator coil, filters, etc.) static pressure drops.
- Static pressure drops from the supply fan to the space (optional heat + curb + supply ESP) cannot exceed 4.0 in w.c.
- Curve can show combined operating min/max for multiple tonnages. Refer to general data for appropriate operating parameters such as motor horsepower and airflow ranges.
- Shaded areas represent unavailable selections. Contact your local Trane representative for more information on selections in these shaded regions.
- Max RPM is indicated on curve and RPM values are in increments of 100RPM unless otherwise shown.
- Catalog curves represent fan data corrected to the following standard conditions: 70°F dry bulb temperature, barometric pressure of 14.696 psia, and an air density of 0.075 lb/ft<sup>3</sup>. Use Trane Select Assist to generate fan curves for unit-specific operating temperatures and elevations.

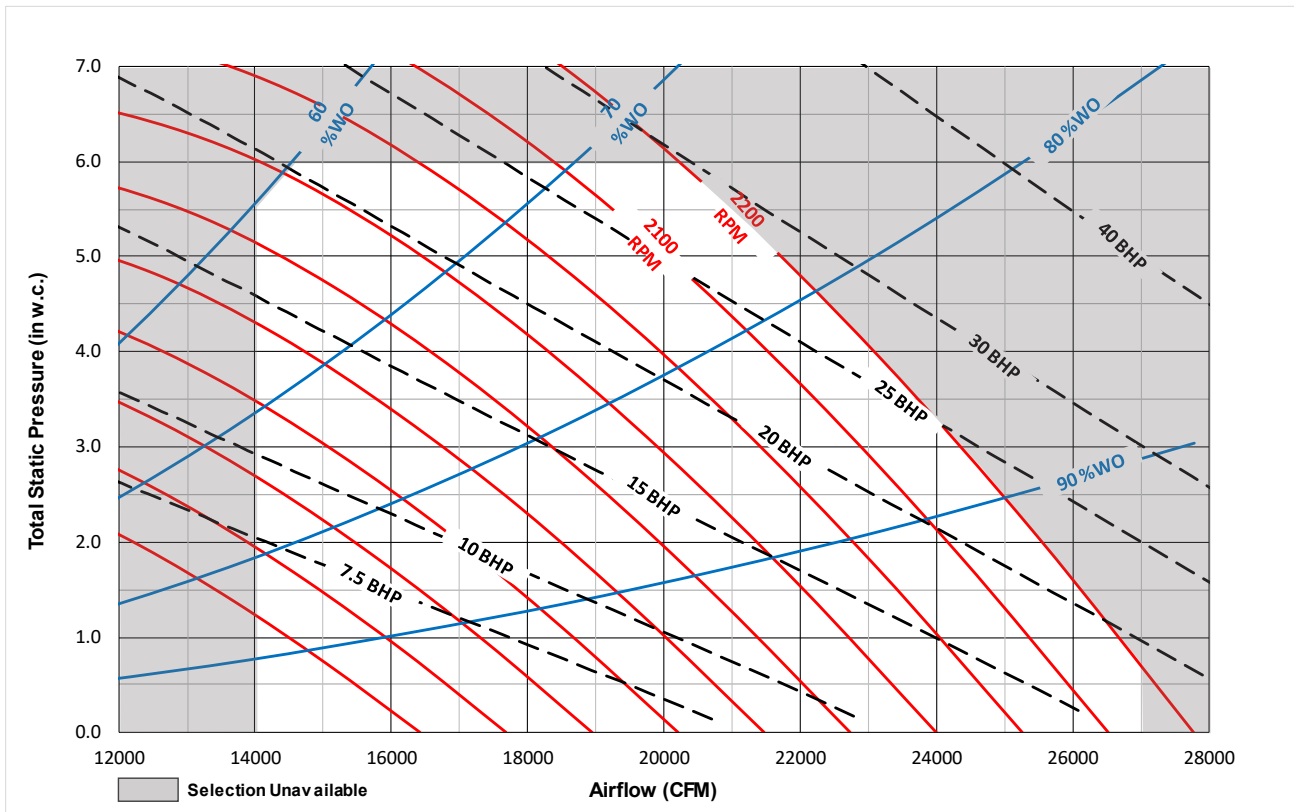

**Figure 21. Supply fan performance - 60 ton cooling only- direct drive plenum, 80% width**

**Notes:**

- Supply fan performance curve includes internal resistance of rooftop. For total static pressure determination, system external static must be added to appropriate component (evaporator coil, filters, etc.) static pressure drops.
- Static pressure drops from the supply fan to the space (optional heat + curb + supply ESP) cannot exceed 4.0 in w.c.
- Curve can show combined operating min/max for multiple tonnages. Refer to general data for appropriate operating parameters such as motor horsepower and airflow ranges.
- Shaded areas represent unavailable selections. Contact your local Trane representative for more information on selections in these shaded regions.
- Max RPM is indicated on curve and RPM values are in increments of 100RPM unless otherwise shown.
- Catalog curves represent fan data corrected to the following standard conditions: 70°F dry bulb temperature, barometric pressure of 14.696 psia, and an air density of 0.075 lb/ft<sup>3</sup>. Use Trane Select Assist to generate fan curves for unit-specific operating temperatures and elevations.

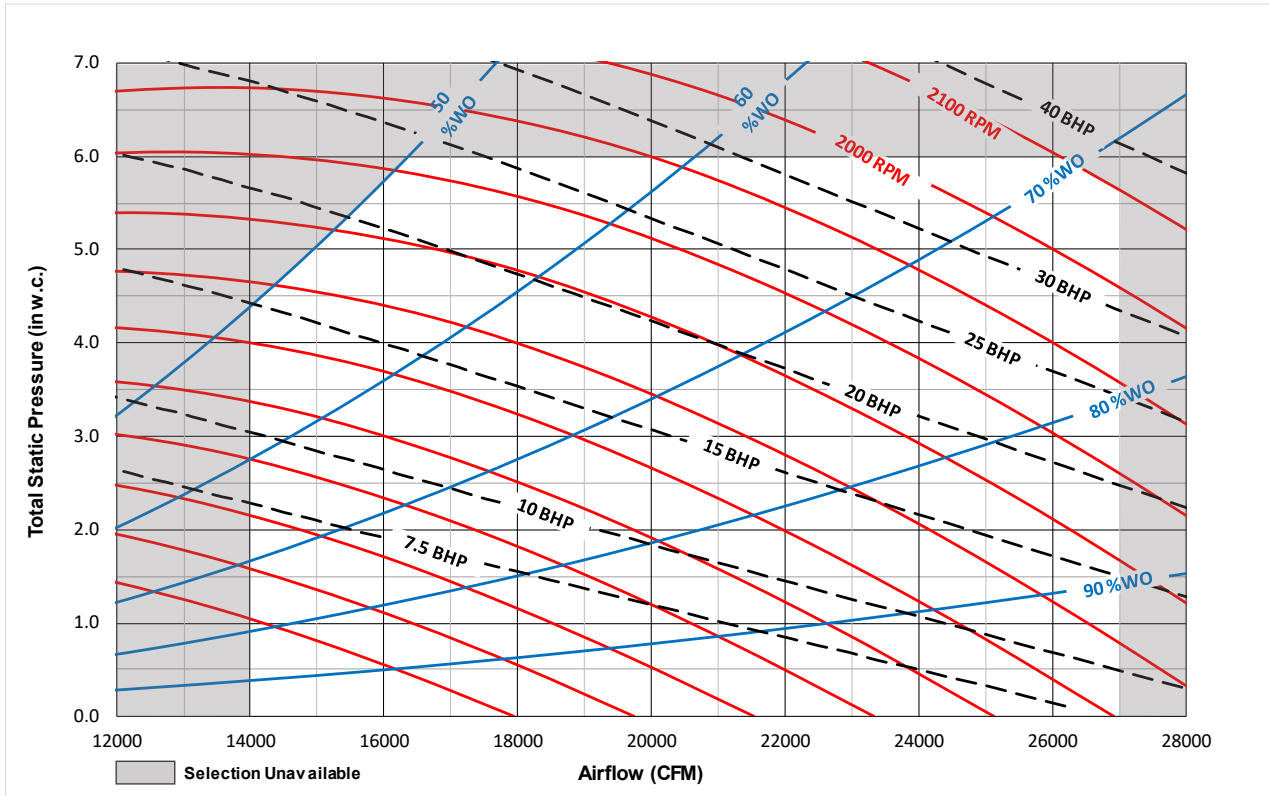

## Performance Data

Figure 22. Supply fan performance - 60 ton cooling only- direct drive plenum, 120% width



### Notes:

- Supply fan performance curve includes internal resistance of rooftop. For total static pressure determination, system external static must be added to appropriate component (evaporator coil, filters, etc.) static pressure drops.
- Static pressure drops from the supply fan to the space (optional heat + curb + supply ESP) cannot exceed 4.0 in w.c.
- Curve can show combined operating min/max for multiple tonnages. Refer to general data for appropriate operating parameters such as motor horsepower and airflow ranges.
- Shaded areas represent unavailable selections. Contact your local Trane representative for more information on selections in these shaded regions.
- Max RPM is indicated on curve and RPM values are in increments of 100RPM unless otherwise shown.
- Catalog curves represent fan data corrected to the following standard conditions: 70°F dry bulb temperature, barometric pressure of 14.696 psia, and an air density of 0.075 lb/ft<sup>3</sup>. Use Trane Select Assist to generate fan curves for unit-specific operating temperatures and elevations.

Figure 23. Supply fan performance - 70 and 75 tons cooling only- direct drive plenum, 80% width

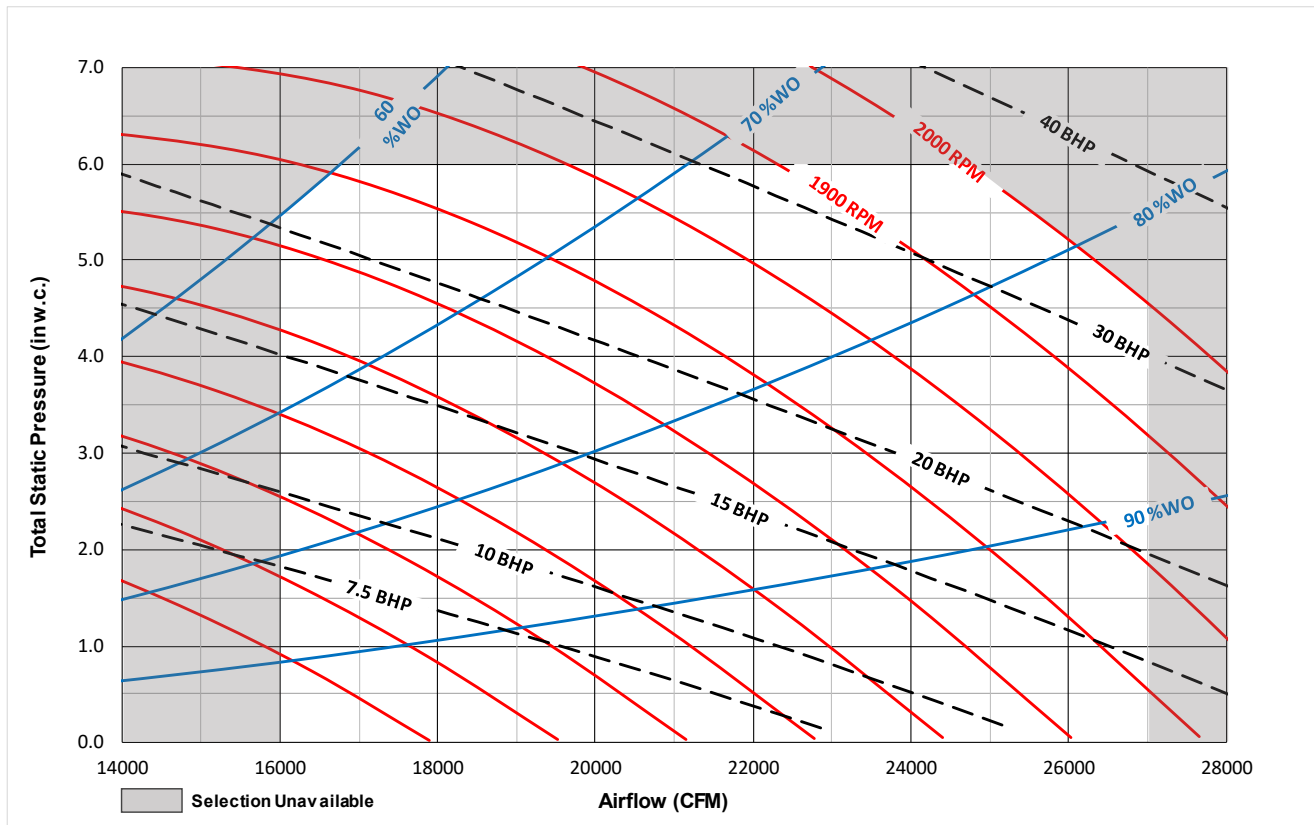

**Notes:**

- Supply fan performance curve includes internal resistance of rooftop. For total static pressure determination, system external static must be added to appropriate component (evaporator coil, filters, etc.) static pressure drops.
- Static pressure drops from the supply fan to the space (optional heat + curb + supply ESP) cannot exceed 4.0 in w.c.
- Curve can show combined operating min/max for multiple tonnages. Refer to general data for appropriate operating parameters such as motor horsepower and airflow ranges.
- Shaded areas represent unavailable selections. Contact your local Trane representative for more information on selections in these shaded regions.
- Max RPM is indicated on curve and RPM values are in increments of 100RPM unless otherwise shown.
- Catalog curves represent fan data corrected to the following standard conditions: 70°F dry bulb temperature, barometric pressure of 14.696 psia, and an air density of 0.075 lb/ft<sup>3</sup>. Use Trane Select Assist to generate fan curves for unit-specific operating temperatures and elevations.



## Performance Data

Figure 24. Supply fan performance - 70 and 75 tons cooling only- direct drive plenum, 120% width

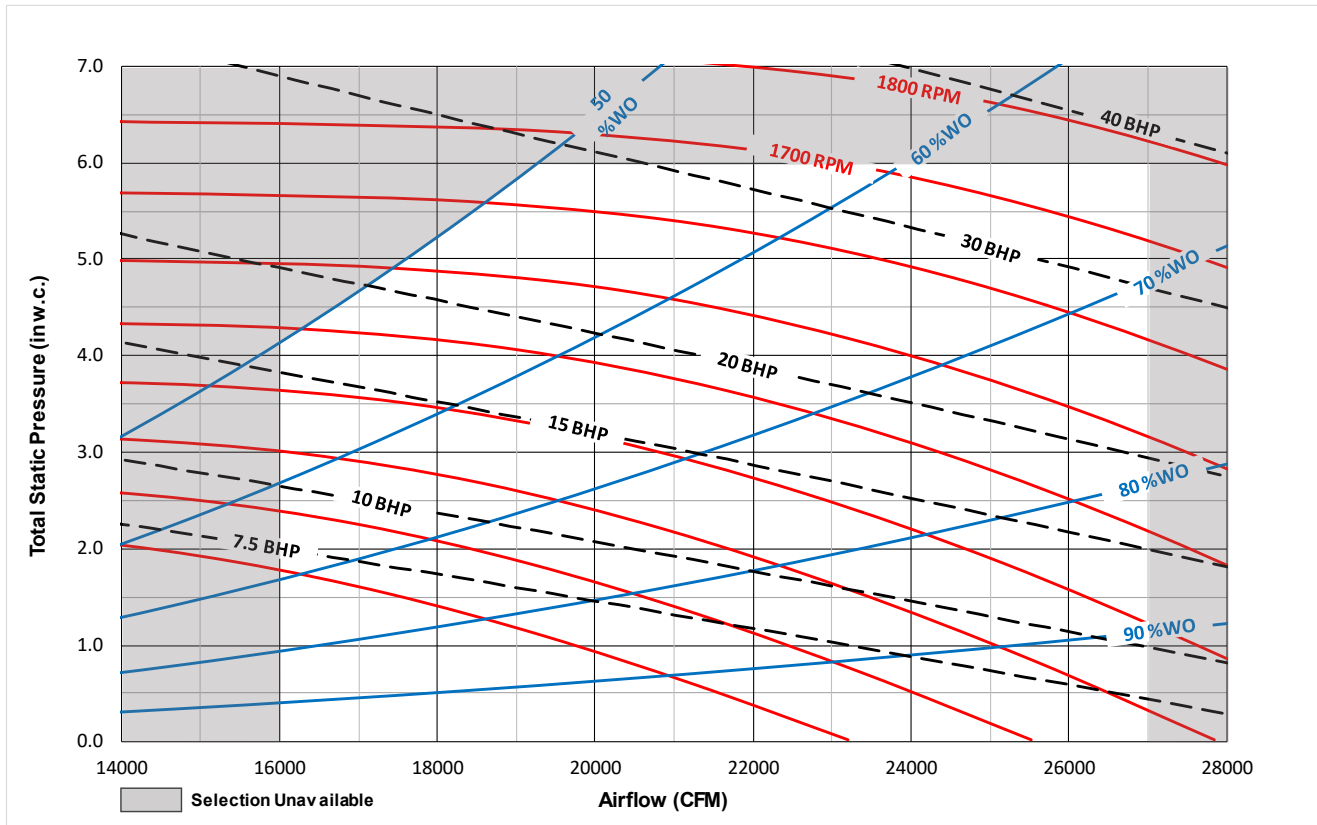

### Notes:

- Supply fan performance curve includes internal resistance of rooftop. For total static pressure determination, system external static must be added to appropriate component (evaporator coil, filters, etc.) static pressure drops.
- Static pressure drops from the supply fan to the space (optional heat + curb + supply ESP) cannot exceed 4.0 in w.c.
- Curve can show combined operating min/max for multiple tonnages. Refer to general data for appropriate operating parameters such as motor horsepower and airflow ranges.
- Shaded areas represent unavailable selections. Contact your local Trane representative for more information on selections in these shaded regions.
- Max RPM is indicated on curve and RPM values are in increments of 100RPM unless otherwise shown.
- Catalog curves represent fan data corrected to the following standard conditions: 70°F dry bulb temperature, barometric pressure of 14.696 psia, and an air density of 0.075 lb/ft<sup>3</sup>. Use Trane Select Assist to generate fan curves for unit-specific operating temperatures and elevations.

Figure 25. Supply fan performance - 60, 70, and 75 tons gas heat - direct drive plenum, 80% width

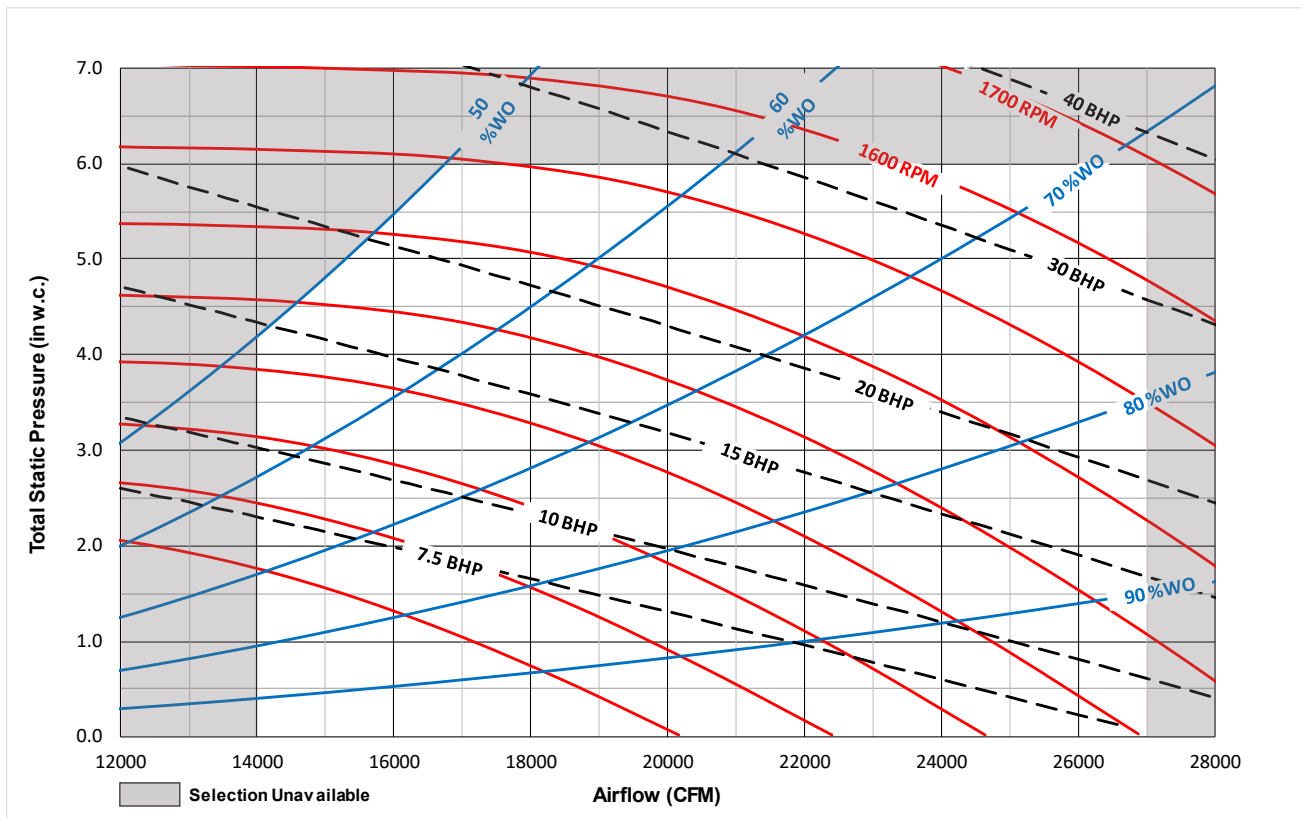

**Notes:**

- Supply fan performance curve includes internal resistance of rooftop. For total static pressure determination, system external static must be added to appropriate component (evaporator coil, filters, etc.) static pressure drops.
- Static pressure drops from the supply fan to the space (optional heat + curb + supply ESP) cannot exceed 4.0 in w.c.
- Curve can show combined operating min/max for multiple tonnages. Refer to general data for appropriate operating parameters such as motor horsepower and airflow ranges.
- Shaded areas represent unavailable selections. Contact your local Trane representative for more information on selections in these shaded regions.
- Max RPM is indicated on curve and RPM values are in increments of 100RPM unless otherwise shown.
- Catalog curves represent fan data corrected to the following standard conditions: 70°F dry bulb temperature, barometric pressure of 14.696 psia, and an air density of 0.075 lb/ft<sup>3</sup>. Use Trane Select Assist to generate fan curves for unit-specific operating temperatures and elevations.



## Performance Data

Figure 26. Supply fan performance - 60, 70, and 75 tons gas heat - direct drive plenum, 100% width

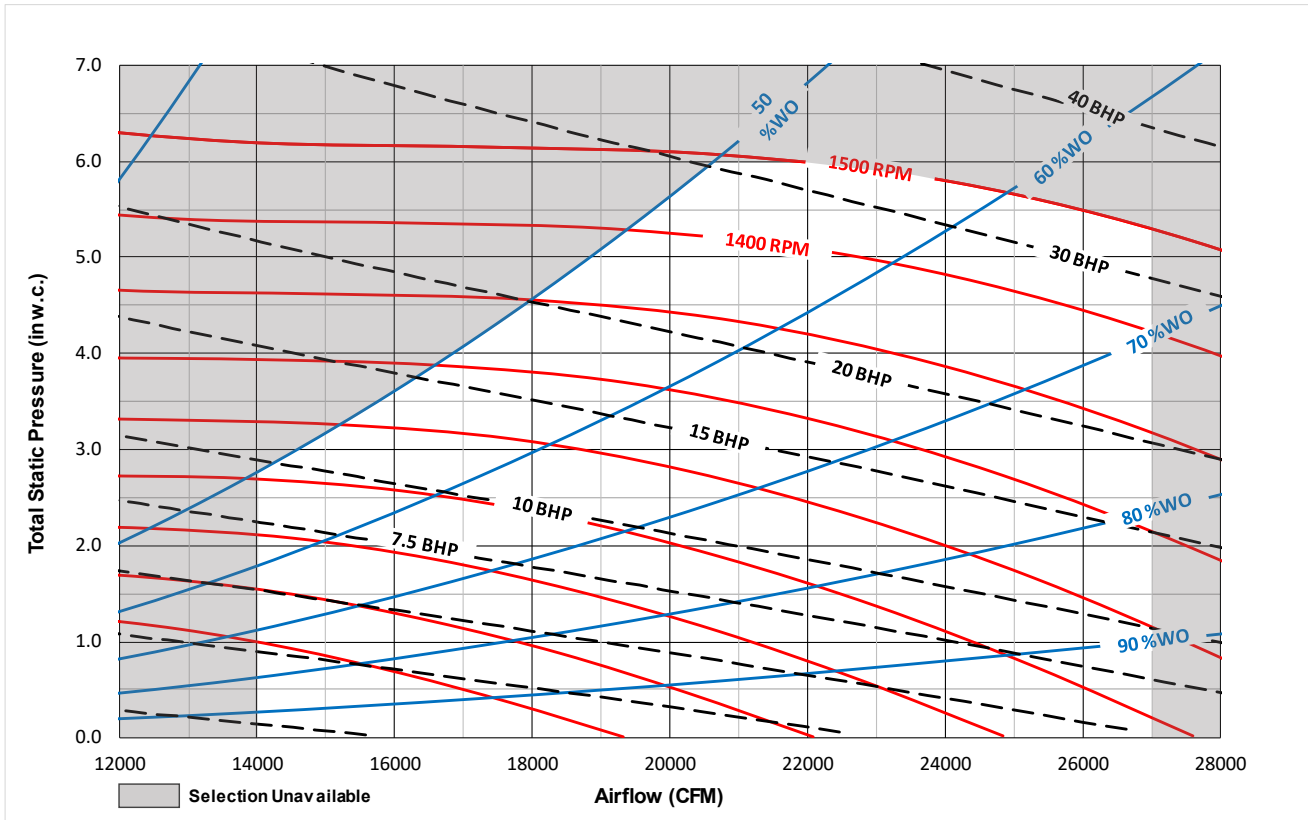

### Notes:

- Supply fan performance curve includes internal resistance of rooftop. For total static pressure determination, system external static must be added to appropriate component (evaporator coil, filters, etc.) static pressure drops.
- Static pressure drops from the supply fan to the space (optional heat + curb + supply ESP) cannot exceed 4.0 in w.c.
- Curve can show combined operating min/max for multiple tonnages. Refer to general data for appropriate operating parameters such as motor horsepower and airflow ranges.
- Shaded areas represent unavailable selections. Contact your local Trane representative for more information on selections in these shaded regions.
- Max RPM is indicated on curve and RPM values are in increments of 100RPM unless otherwise shown.
- Catalog curves represent fan data corrected to the following standard conditions: 70°F dry bulb temperature, barometric pressure of 14.696 psia, and an air density of 0.075 lb/ft<sup>3</sup>. Use Trane Select Assist to generate fan curves for unit-specific operating temperatures and elevations.

Figure 27. Supply fan performance - 90, 105, 115, and 130 ton

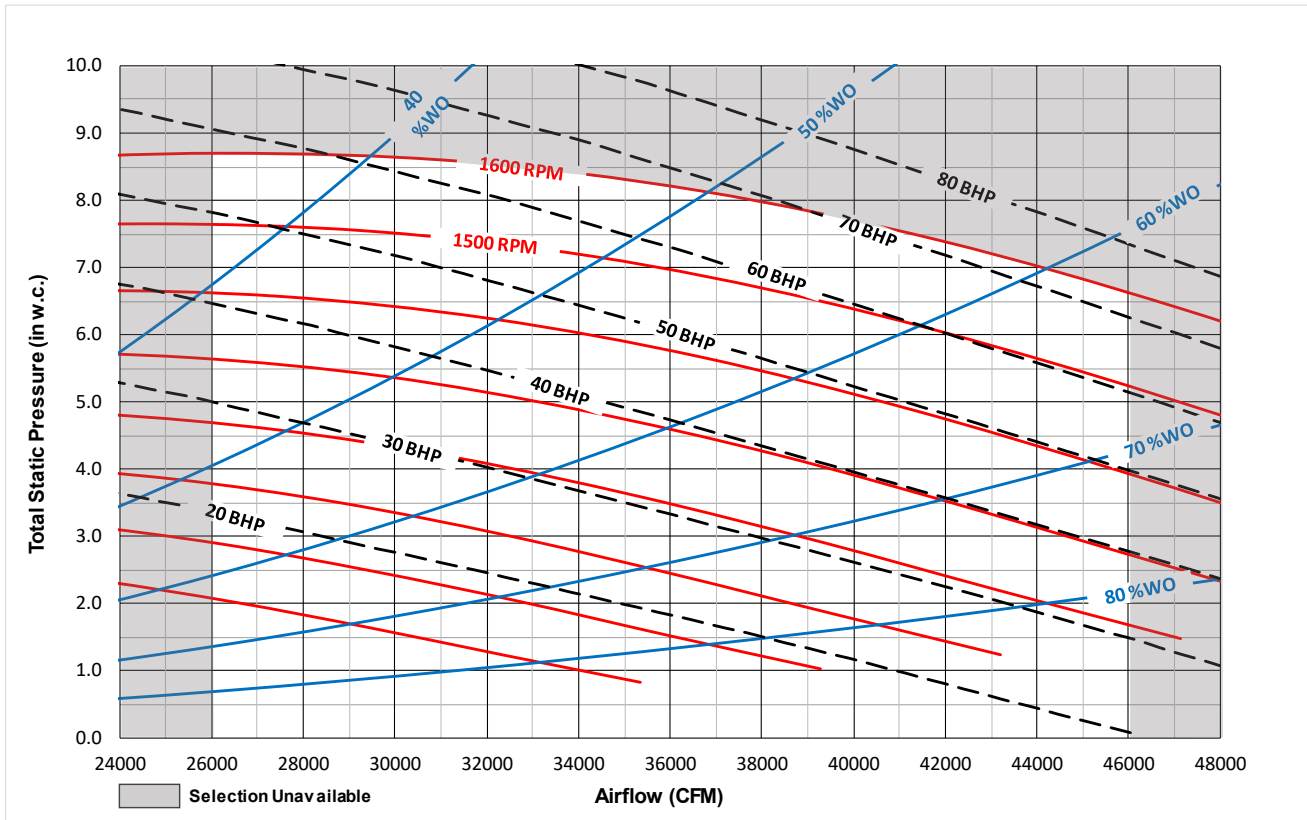

**Notes:**

- Supply fan performance curve includes internal resistance of rooftop. For total static pressure determination, system external static must be added to appropriate component (evaporator coil, filters, etc.) static pressure drops.
- Static pressure drops from the supply fan to the space (optional heat + curb + supply ESP) cannot exceed 4.0 in w.c.
- Curve can show combined operating min/max for multiple tonnages. Refer to general data for appropriate operating parameters such as motor horsepower and airflow ranges.
- Shaded areas represent unavailable selections. Contact your local Trane representative for more information on selections in these shaded regions.
- Max RPM is indicated on curve and RPM values are in increments of 100RPM unless otherwise shown.
- Catalog curves represent fan data corrected to the following standard conditions: 70°F dry bulb temperature, barometric pressure of 14.696 psia, and an air density of 0.075 lb/ft<sup>3</sup>. Use Trane Select Assist to generate fan curves for unit-specific operating temperatures and elevations.



## Performance Data

Figure 28. Relief fan performance - 20, 25, and 30 tons

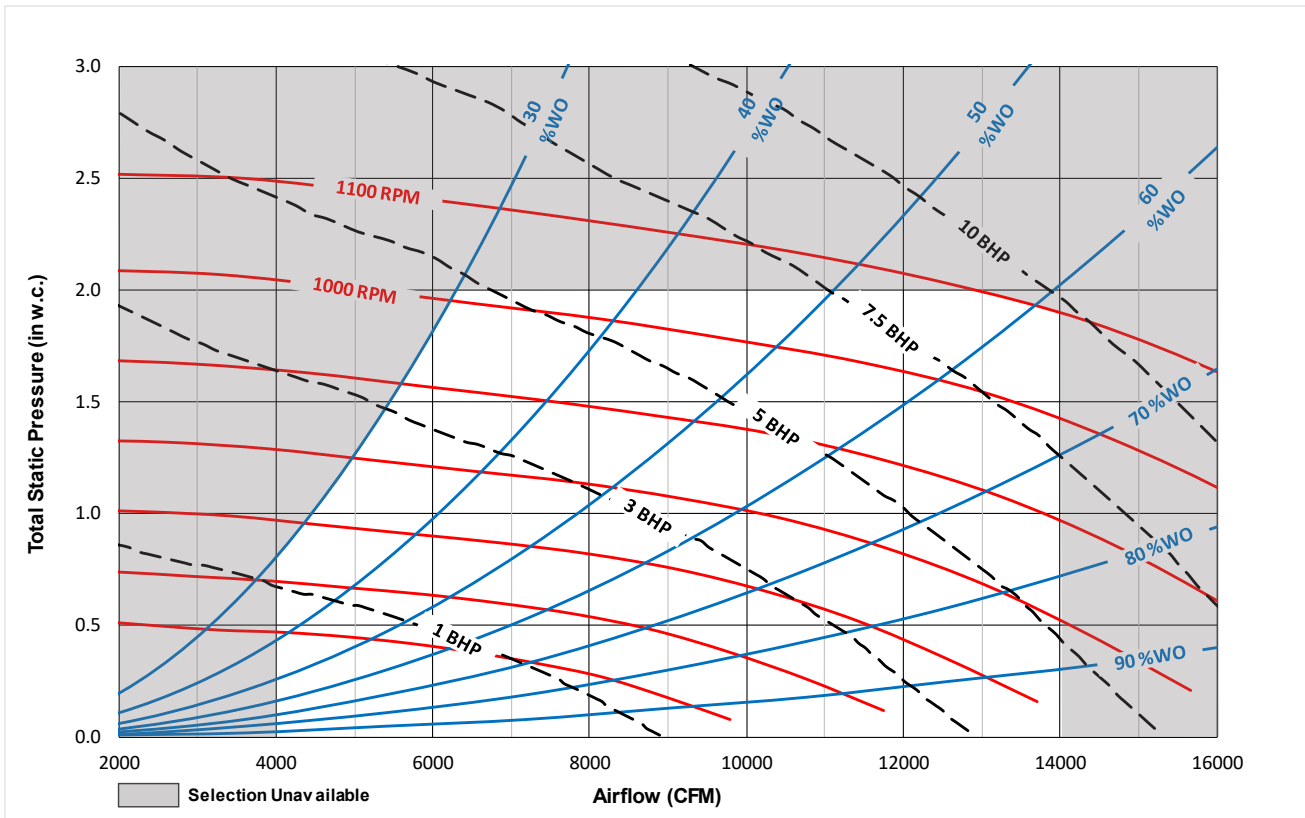

### Notes:

- Supply fan performance curve includes internal resistance of rooftop. For total static pressure determination, system external static must be added to appropriate component (evaporator coil, filters, etc.) static pressure drops.
- Static pressure drops from the supply fan to the space (optional heat + curb + supply ESP) cannot exceed 4.0 in w.c.
- Curve can show combined operating min/max for multiple tonnages. Refer to general data for appropriate operating parameters such as motor horsepower and airflow ranges.
- Shaded areas represent unavailable selections. Contact your local Trane representative for more information on selections in these shaded regions.
- Max RPM is indicated on curve and RPM values are in increments of 100RPM unless otherwise shown.
- Catalog curves represent fan data corrected to the following standard conditions: 70°F dry bulb temperature, barometric pressure of 14.696 psia, and an air density of 0.075 lb/ft<sup>3</sup>. Use Trane Select Assist to generate fan curves for unit-specific operating temperatures and elevations.



Figure 29. Relief fan performance - 40, 50, and 55 tons

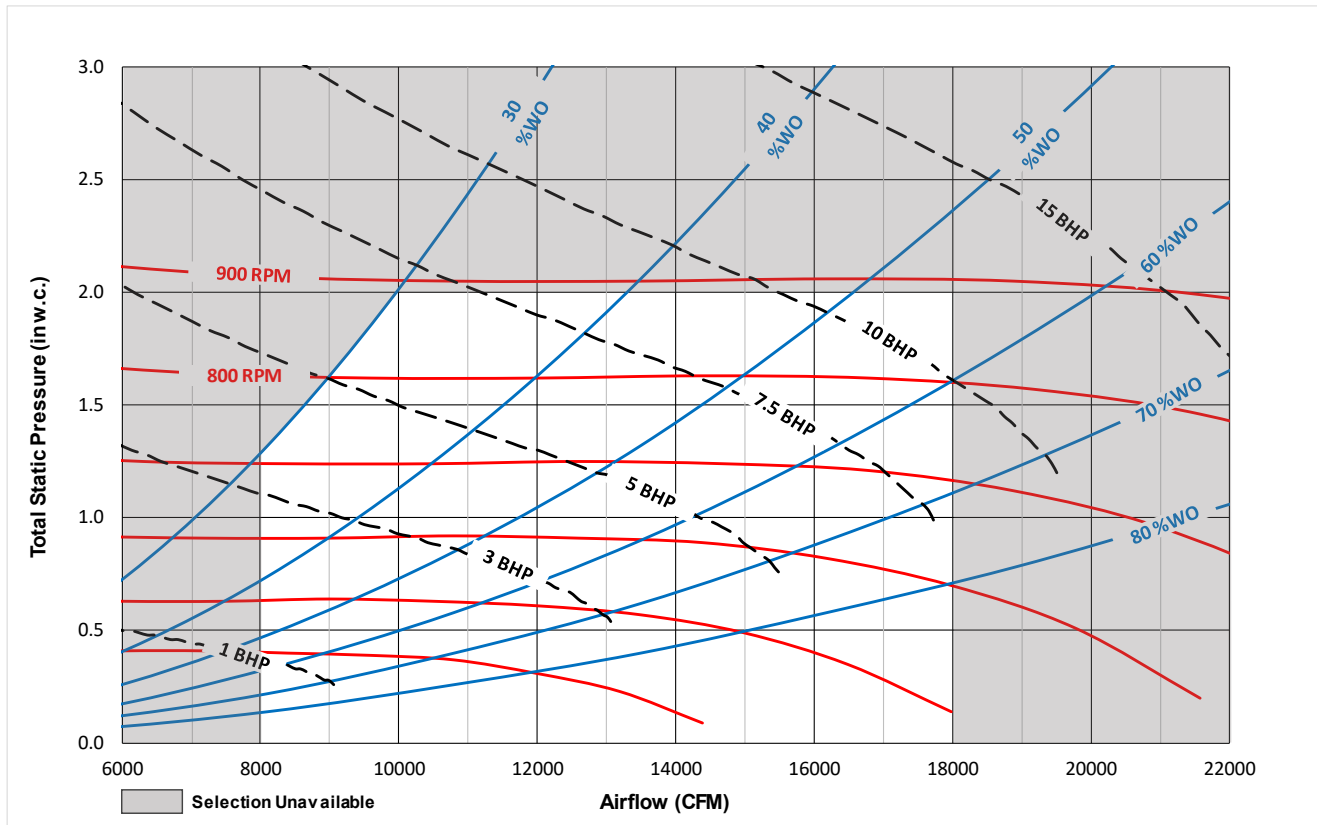

**Notes:**

- Supply fan performance curve includes internal resistance of rooftop. For total static pressure determination, system external static must be added to appropriate component (evaporator coil, filters, etc.) static pressure drops.
- Static pressure drops from the supply fan to the space (optional heat + curb + supply ESP) cannot exceed 4.0 in w.c.
- Curve can show combined operating min/max for multiple tonnages. Refer to general data for appropriate operating parameters such as motor horsepower and airflow ranges.
- Shaded areas represent unavailable selections. Contact your local Trane representative for more information on selections in these shaded regions.
- Max RPM is indicated on curve and RPM values are in increments of 100RPM unless otherwise shown.
- Catalog curves represent fan data corrected to the following standard conditions: 70°F dry bulb temperature, barometric pressure of 14.696 psia, and an air density of 0.075 lb/ft<sup>3</sup>. Use Trane Select Assist to generate fan curves for unit-specific operating temperatures and elevations.



## Performance Data

Figure 30. Relief fan performance - 60, 70, and 75 tons

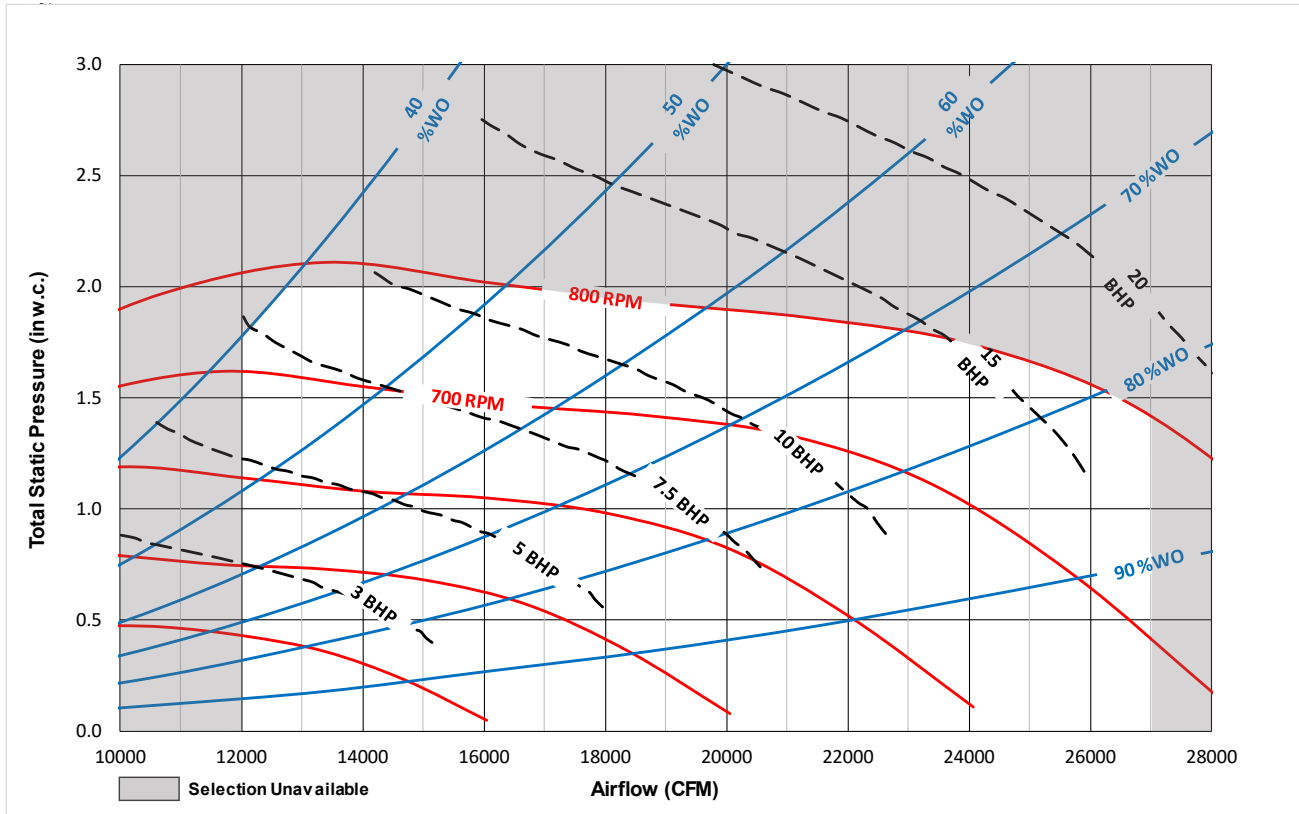

### Notes:

- Supply fan performance curve includes internal resistance of rooftop. For total static pressure determination, system external static must be added to appropriate component (evaporator coil, filters, etc.) static pressure drops.
- Static pressure drops from the supply fan to the space (optional heat + curb + supply ESP) cannot exceed 4.0 in w.c.
- Curve can show combined operating min/max for multiple tonnages. Refer to general data for appropriate operating parameters such as motor horsepower and airflow ranges.
- Shaded areas represent unavailable selections. Contact your local Trane representative for more information on selections in these shaded regions.
- Max RPM is indicated on curve and RPM values are in increments of 100RPM unless otherwise shown.
- Catalog curves represent fan data corrected to the following standard conditions: 70°F dry bulb temperature, barometric pressure of 14.696 psia, and an air density of 0.075 lb/ft<sup>3</sup>. Use Trane Select Assist to generate fan curves for unit-specific operating temperatures and elevations.

Figure 31. Relief fan performance - 90, 105, 115, and 130 tons

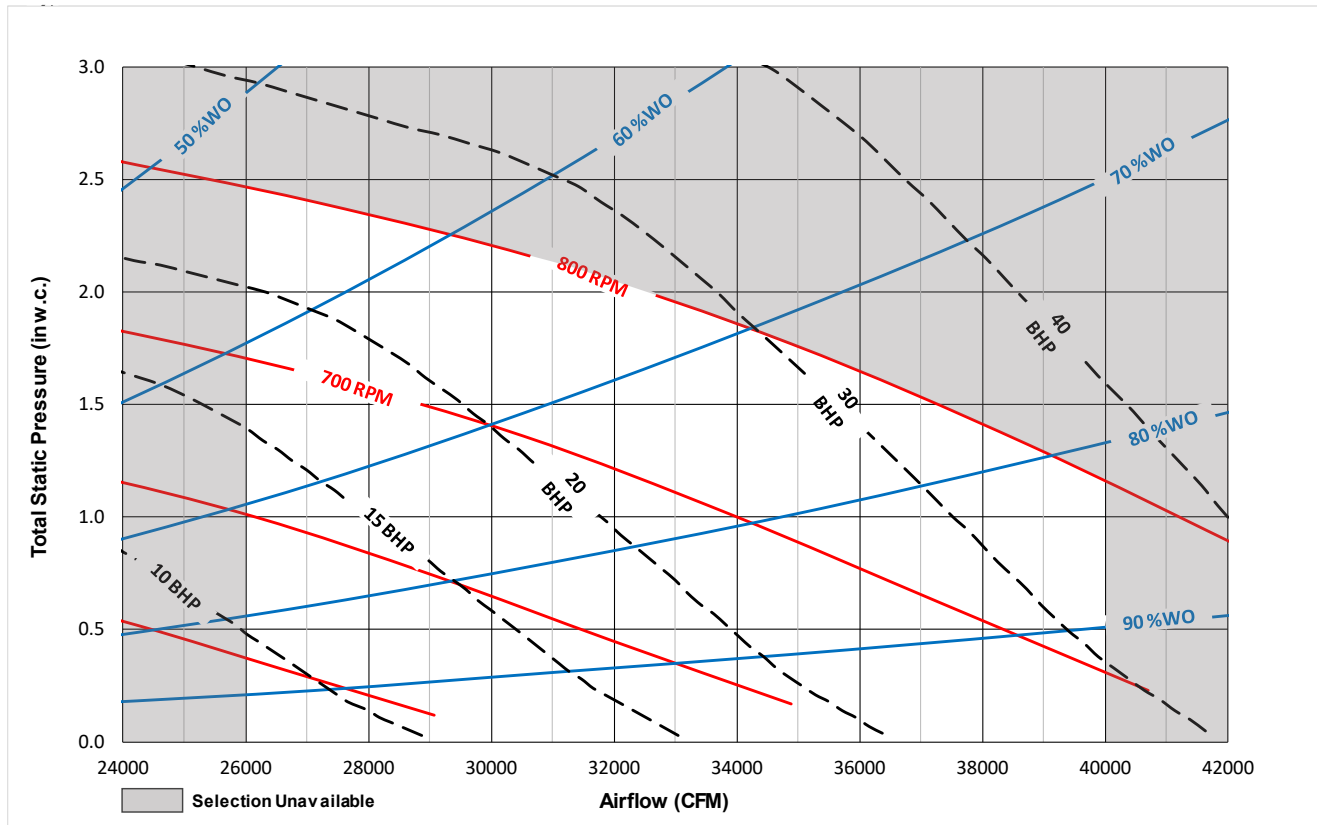

**Notes:**

- Supply fan performance curve includes internal resistance of rooftop. For total static pressure determination, system external static must be added to appropriate component (evaporator coil, filters, etc.) static pressure drops.
- Static pressure drops from the supply fan to the space (optional heat + curb + supply ESP) cannot exceed 4.0 in w.c.
- Curve can show combined operating min/max for multiple tonnages. Refer to general data for appropriate operating parameters such as motor horsepower and airflow ranges.
- Shaded areas represent unavailable selections. Contact your local Trane representative for more information on selections in these shaded regions.
- Max RPM is indicated on curve and RPM values are in increments of 100RPM unless otherwise shown.
- Catalog curves represent fan data corrected to the following standard conditions: 70°F dry bulb temperature, barometric pressure of 14.696 psia, and an air density of 0.075 lb/ft<sup>3</sup>. Use Trane Select Assist to generate fan curves for unit-specific operating temperatures and elevations.



## Performance Data

Figure 32. Return fan performance - 20, 25, and 30 tons

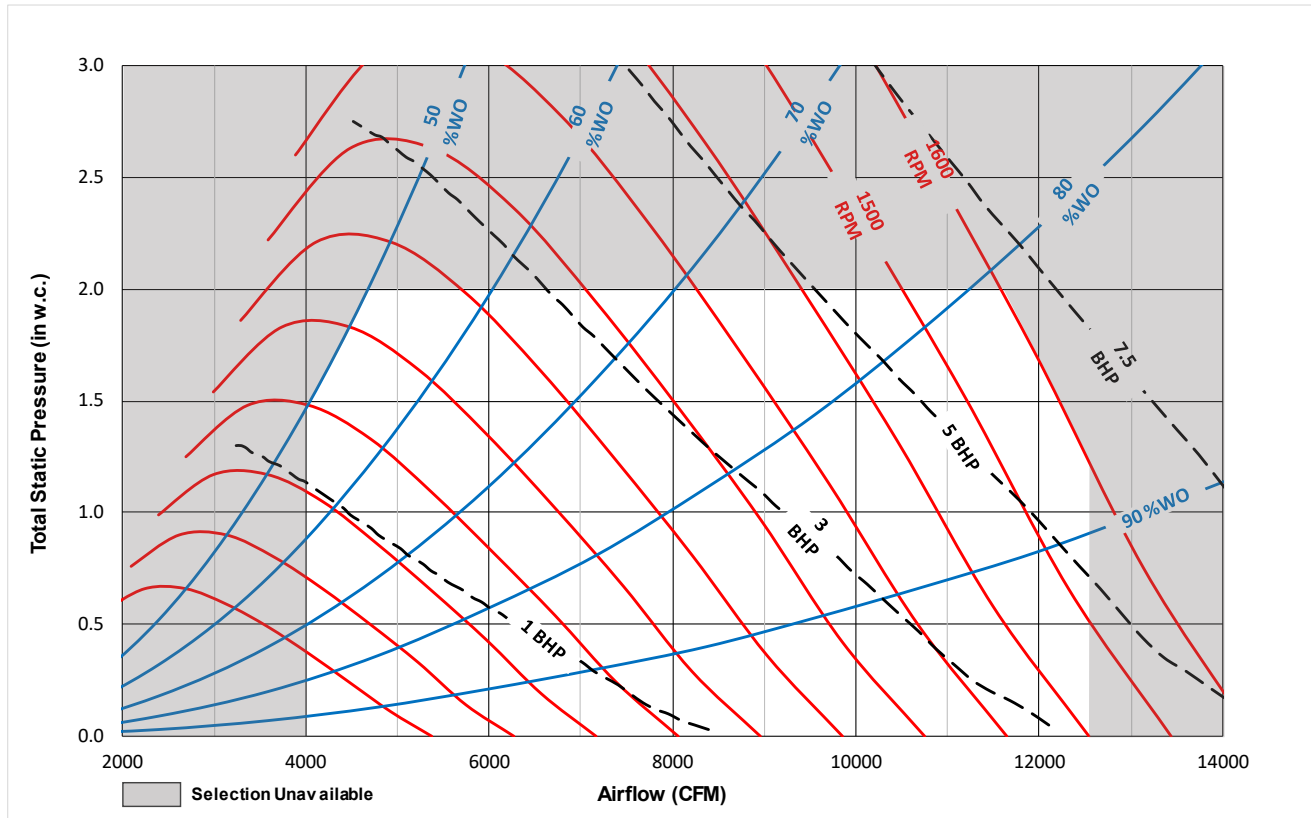

### Notes:

- Supply fan performance curve includes internal resistance of rooftop. For total static pressure determination, system external static must be added to appropriate component (evaporator coil, filters, etc.) static pressure drops.
- Static pressure drops from the supply fan to the space (optional heat + curb + supply ESP) cannot exceed 4.0 in w.c.
- Curve can show combined operating min/max for multiple tonnages. Refer to general data for appropriate operating parameters such as motor horsepower and airflow ranges.
- Shaded areas represent unavailable selections. Contact your local Trane representative for more information on selections in these shaded regions.
- Max RPM is indicated on curve and RPM values are in increments of 100RPM unless otherwise shown.
- Catalog curves represent fan data corrected to the following standard conditions: 70°F dry bulb temperature, barometric pressure of 14.696 psia, and an air density of 0.075 lb/ft<sup>3</sup>. Use Trane Select Assist to generate fan curves for unit-specific operating temperatures and elevations.

Figure 33. Return fan performance - 40, 50, and 55 tons

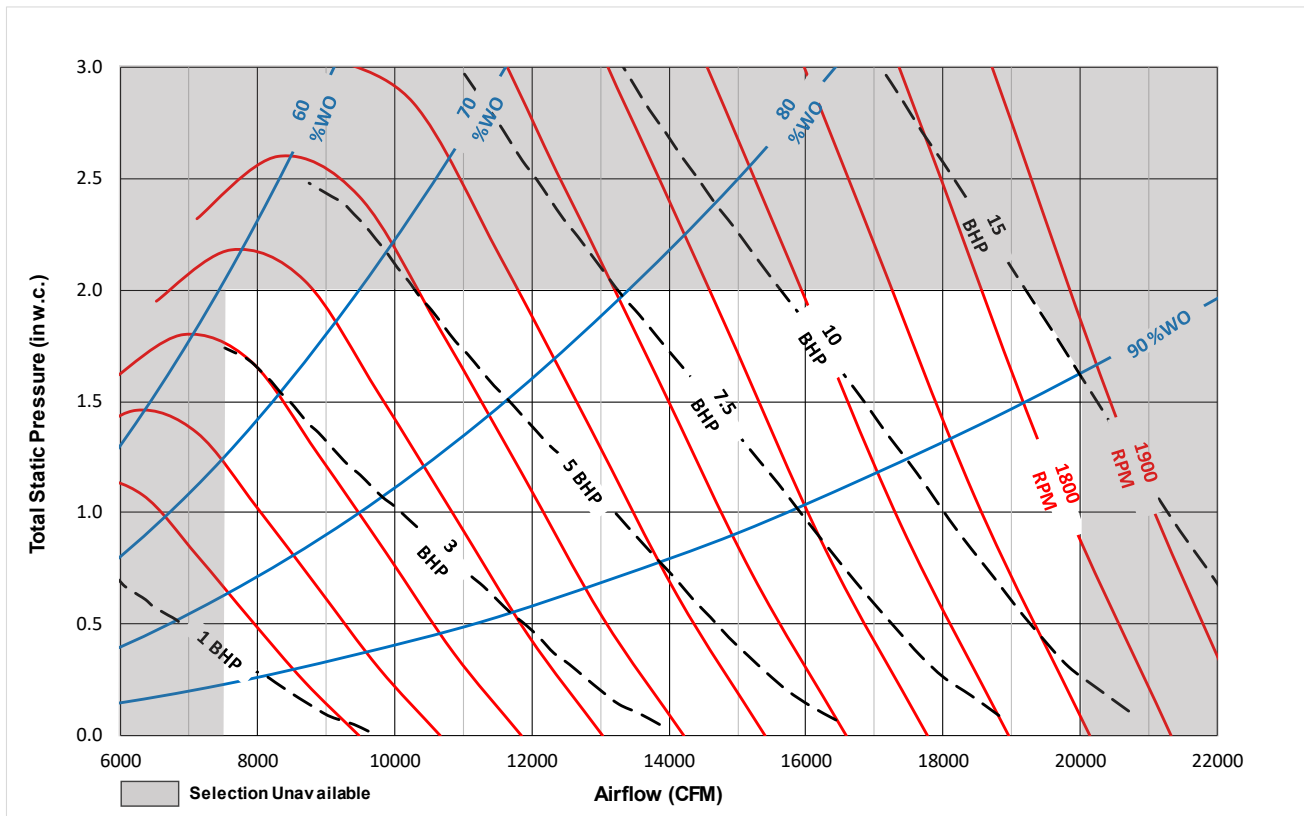

**Notes:**

- Supply fan performance curve includes internal resistance of rooftop. For total static pressure determination, system external static must be added to appropriate component (evaporator coil, filters, etc.) static pressure drops.
- Static pressure drops from the supply fan to the space (optional heat + curb + supply ESP) cannot exceed 4.0 in w.c.
- Curve can show combined operating min/max for multiple tonnages. Refer to general data for appropriate operating parameters such as motor horsepower and airflow ranges.
- Shaded areas represent unavailable selections. Contact your local Trane representative for more information on selections in these shaded regions.
- Max RPM is indicated on curve and RPM values are in increments of 100RPM unless otherwise shown.
- Catalog curves represent fan data corrected to the following standard conditions: 70°F dry bulb temperature, barometric pressure of 14.696 psia, and an air density of 0.075 lb/ft<sup>3</sup>. Use Trane Select Assist to generate fan curves for unit-specific operating temperatures and elevations.



## Performance Data

Figure 34. Return fan performance - 60, 70, and 75 tons

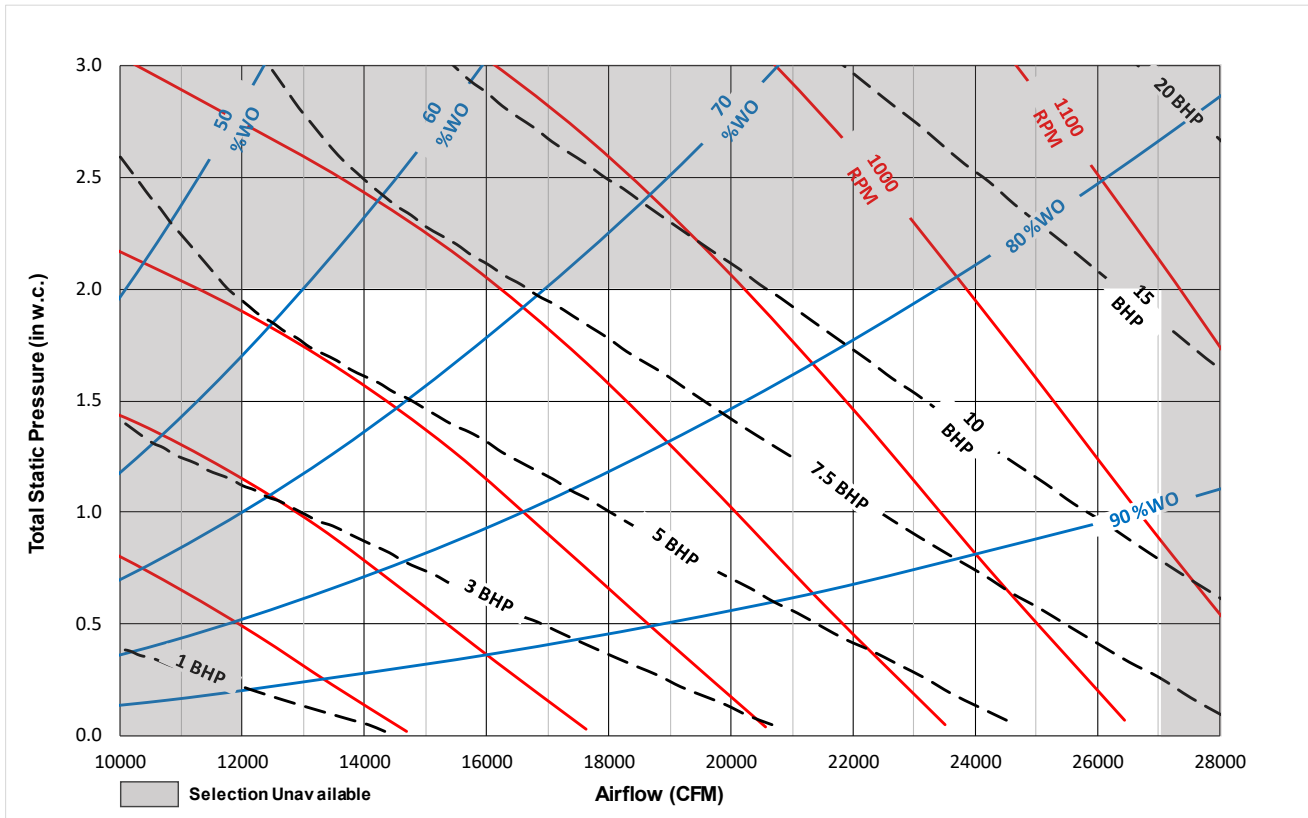

### Notes:

- Supply fan performance curve includes internal resistance of rooftop. For total static pressure determination, system external static must be added to appropriate component (evaporator coil, filters, etc.) static pressure drops.
- Static pressure drops from the supply fan to the space (optional heat + curb + supply ESP) cannot exceed 4.0 in w.c.
- Curve can show combined operating min/max for multiple tonnages. Refer to general data for appropriate operating parameters such as motor horsepower and airflow ranges.
- Shaded areas represent unavailable selections. Contact your local Trane representative for more information on selections in these shaded regions.
- Max RPM is indicated on curve and RPM values are in increments of 100RPM unless otherwise shown.
- Catalog curves represent fan data corrected to the following standard conditions: 70°F dry bulb temperature, barometric pressure of 14.696 psia, and an air density of 0.075 lb/ft<sup>3</sup>. Use Trane Select Assist to generate fan curves for unit-specific operating temperatures and elevations.

# Component Static Pressure Drops

**Table 56. Component static pressure drops (in. W.G.), 20 to 75 tons air-cooled**

Norm	CFM Std	Evap Coil		Heating System										Filters					Econ w/ or w/out Relief	HGRH		
		Dry	Wet	SFH - FC		SFH - DDP		SHE All kW		SLH		SSH		Throwaway		Perm Wire	Bag & Pre	Cart & Pre			Final Cart	Std Roof
				Low	High	Low	High	Low	High	Low	High	Low	High	Std	High							
20	4000	0.12	0.16	N/A	0.09	N/A	0.02	0.06	0.05	0.06	0.02	0.06	0.03	0.03	0.01	0.30	0.24	0.22	0.01	0.03	0.01	0.03
	6000	0.24	0.29	0.05	0.21	0.22	0.04	0.09	0.12	0.12	0.05	0.12	0.06	0.06	0.02	0.50	0.44	0.30	0.02	0.06	0.02	0.06
	8000	0.37	0.44	0.09	0.39	0.39	0.07	0.15	0.19	0.19	0.10	0.20	0.09	0.09	0.03	0.71	0.68	0.45	0.05	0.12	0.04	0.04
25	9000	0.45	0.52	0.12	0.48	0.50	0.09	0.19	0.24	0.12	0.22	0.12	0.22	0.11	0.04	0.83	0.81	0.55	0.07	0.15	0.05	0.05
	5000	0.18	0.22	N/A	0.04	N/A	0.03	0.07	0.09	0.04	0.09	0.04	0.09	0.05	0.02	0.40	0.34	0.25	0.01	0.03	0.01	0.03
	6000	0.24	0.29	0.05	0.21	0.22	0.04	0.10	0.12	0.10	0.12	0.06	0.13	0.07	0.02	0.50	0.44	0.30	0.02	0.05	0.02	0.05
30	7500	0.34	0.41	0.08	0.31	0.35	0.06	0.14	0.17	0.09	0.18	0.09	0.18	0.09	0.03	0.66	0.62	0.41	0.04	0.10	0.03	0.03
	10000	0.53	0.62	0.14	0.58	0.61	0.11	0.23	0.28	0.15	0.29	0.13	0.13	0.13	0.05	0.95	0.95	0.66	0.10	0.19	0.06	0.06
	11000	0.62	0.71	0.17	0.71	0.74	0.13	0.29	0.33	0.19	0.35	0.19	0.35	0.15	0.06	1.06	1.11	0.79	0.12	0.23	0.07	0.07
40	6000	0.17	0.24	0.05	0.08	0.13	0.04	0.09	0.12	0.05	0.12	0.05	0.12	0.04	0.01	0.34	0.26	0.24	0.02	0.06	0.02	0.02
	9000	0.33	0.45	0.11	0.17	0.29	0.09	0.19	0.24	0.12	0.22	0.12	0.22	0.07	0.02	0.54	0.48	0.36	0.07	0.15	0.04	0.04
	12000	0.53	0.67	0.20	0.21	0.30	0.16	0.31	0.39	0.22	0.41	0.11	0.11	0.11	0.04	0.75	0.75	0.58	0.16	0.27	0.07	0.07
50-55	14000	0.68	0.83	0.26	0.29	0.39	0.22	0.40	0.51	0.30	0.50	0.14	0.14	0.14	0.06	0.95	0.95	0.76	0.25	0.39	0.09	0.09
	8000	0.19	0.26	0.09	N/A	0.13	0.07	0.09	0.11	0.05	0.11	0.05	0.11	0.04	0.02	0.37	0.31	0.25	0.01	0.03	0.02	0.02
	10000	0.27	0.36	0.14	0.20	0.37	0.11	0.13	0.16	0.08	0.16	0.08	0.16	0.06	0.02	0.49	0.43	0.32	0.02	0.03	0.03	0.03
60	12000	0.36	0.48	0.20	0.15	0.28	0.16	0.17	0.22	0.11	0.21	0.08	0.08	0.08	0.03	0.61	0.56	0.41	0.04	0.07	0.05	0.05
	16000	0.57	0.73	0.34	0.26	0.49	0.29	0.28	0.36	0.20	0.36	0.12	0.12	0.12	0.05	0.88	0.87	0.66	0.10	0.09	0.08	0.08
	17000	0.62	0.79	N/A	0.29	0.55	0.77	0.32	0.31	0.39	0.22	0.41	0.13	0.13	0.06	0.95	0.95	0.74	0.12	0.11	0.10	0.10
70-75	18000	0.68	0.86	N/A	0.33	N/A	0.83	0.35	0.43	0.25	0.44	0.14	0.14	0.14	0.07	1.02	1.04	0.83	0.14	0.13	0.11	0.11
	10000	0.20	0.25	0.12	0.10	0.20	0.11	0.13	0.16	0.07	0.15	0.07	0.15	0.04	0.01	0.37	0.30	0.25	0.03	0.05	0.03	0.03
	14000	0.34	0.42	0.26	0.20	0.38	0.17	0.22	0.28	0.15	0.28	0.07	0.28	0.07	0.03	0.56	0.50	0.37	0.07	0.08	0.05	0.05
60	17000	0.46	0.57	0.39	0.29	0.55	0.26	0.32	0.40	0.22	0.41	0.10	0.10	0.10	0.04	0.72	0.68	0.50	0.12	0.11	0.08	0.08
	20000	0.59	0.73	0.58	0.41	0.75	0.38	0.44	0.52	0.30	0.51	0.12	0.12	0.12	0.05	0.88	0.88	0.66	0.19	0.17	0.11	0.11
	23000	0.74	0.89	0.69	0.54	0.99	0.53	0.58	0.67	0.41	0.69	0.15	0.15	0.15	0.07	1.05	N/A	0.87	0.27	0.22	0.14	0.14
60	12000	0.27	0.37	0.10	0.08	0.28	0.14	0.10	0.13	0.06	0.11	0.05	0.11	0.05	0.01	0.44	0.37	0.27	0.02	0.07	0.03	0.03
	16000	0.43	0.58	0.18	0.14	0.44	0.28	0.11	0.17	0.21	0.11	0.19	0.19	0.07	0.02	0.63	0.58	0.39	0.05	0.10	0.06	0.06
	20000	0.62	0.80	0.27	0.21	0.63	0.46	0.17	0.24	0.31	0.16	0.27	0.10	0.10	0.03	0.84	0.82	0.56	0.10	0.16	0.09	0.09
70-75	24000	0.83	1.03	0.40	0.30	0.86	0.68	0.24	0.33	0.42	0.22	0.39	0.11	0.11	0.04	1.06	1.08	0.78	0.16	0.23	0.13	0.13
	26000	0.95	1.20	0.47	0.32	0.98	0.81	0.28	0.39	0.49	0.27	0.45	0.16	0.16	0.05	1.17	1.23	0.91	0.23	0.26	0.15	0.15
	27000	1.01	1.26	0.51	0.33	1.05	0.88	0.30	0.42	0.52	0.30	0.48	0.17	0.17	0.06	1.12	1.26	0.98	0.27	0.28	0.16	0.16

**Notes:**

1. Static pressure drops of accessory components must be added to external static pressure to enter fan selection tables.
2. Gas heat section maximum temperature rise of 60° F.
3. Throwaway filter option limited to 300 ft/min face velocity.
4. Bag filter option limited to 740 ft/min face velocity.
5. Horizontal roof curbs assume 0.50" static pressure drop or double the standard roof curb pressure drop, whichever is greater.
6. No additional pressure loss for model SXH<sub>-</sub>.
7. For final filters w/ prefilters (digit 13 = M, N, P, Q) also add pressure drop for throwaway filter.

Table 57. Component static pressure drops (in. W.G.), 90 to 130 tons air-cooled

Nom	CFM Std	Evap Coil				High Cap Evap				Heating System						Filters						Std Roof	Econ w/ or w/ out Relief		
		Dry		Wet		Dry		Wet		SFHL		SEHL		SLHL		SSHLL		Throwaway		Perm Wire	Bag & Pre			Cart & Pre	Final Cart
		Low	High	Low	High	Low	High	Low	High	Low	High	Low	High	Low	High	Std	High								
90	27000	0.40	0.53	0.60	0.80	N/A	0.25	0.13	N/A	0.26	0.31	0.22	0.32	0.11	0.13	N/A	0.68	0.65	0.77	N/A	N/A	N/A	N/A	0.20	
	32000	0.53	0.70	0.80	1.03	N/A	0.31	0.16	N/A	0.35	0.41	0.30	0.43	0.14	0.16	N/A	0.84	0.84	1.07	N/A	N/A	N/A	N/A	0.31	
	37000	0.67	0.88	1.01	1.32	N/A	0.39	0.23	N/A	0.45	0.52	0.40	0.55	0.17	0.19	N/A	1.02	1.04	1.43	N/A	N/A	N/A	N/A	0.41	
	42000	0.83	1.08	1.25	1.62	N/A	0.46	0.29	N/A	0.56	0.65	0.50	0.68	0.21	0.22	N/A	1.19	1.06	1.86	N/A	N/A	N/A	N/A	0.52	
105	45000	0.93	1.20	1.40	1.80	N/A	0.52	0.32	N/A	0.63	0.73	0.58	0.76	0.24	0.24	N/A	N/A	N/A	2.14	N/A	N/A	N/A	N/A	0.63	
	31000	N/A	N/A	0.63	0.83	N/A	0.28	0.17	N/A	0.33	0.39	0.29	0.40	N/A	0.13	N/A	0.82	0.80	1.00	N/A	N/A	N/A	N/A	0.22	
	35000	N/A	N/A	0.77	1.01	N/A	0.36	0.21	N/A	0.41	0.48	0.36	0.50	N/A	0.16	N/A	0.96	0.96	1.28	N/A	N/A	N/A	N/A	0.32	
	39000	N/A	N/A	0.92	1.20	N/A	0.42	0.26	N/A	0.49	0.57	0.44	0.60	N/A	0.19	N/A	1.09	1.12	1.59	N/A	N/A	N/A	N/A	0.44	
115/ 130	43000	N/A	N/A	1.08	1.40	N/A	0.45	0.30	N/A	0.57	0.66	0.53	0.71	N/A	0.22	N/A	1.22	1.30	1.95	N/A	N/A	N/A	N/A	0.54	
	46000	N/A	N/A	1.21	1.56	N/A	0.55	0.34	N/A	0.65	0.75	0.61	0.79	N/A	0.24	N/A	N/A	N/A	2.24	N/A	N/A	N/A	N/A	0.64	
	31000	0.76	1.00	N/A	N/A	N/A	0.28	0.17	N/A	0.33	0.39	0.29	0.40	N/A	0.13	N/A	0.82	0.80	1.00	N/A	N/A	N/A	N/A	0.22	
	35000	0.92	1.21	N/A	N/A	N/A	0.36	0.21	N/A	0.41	0.48	0.36	0.50	N/A	0.16	N/A	0.96	0.96	1.28	N/A	N/A	N/A	N/A	0.32	
43000	1.10	1.44	N/A	N/A	N/A	0.42	0.26	N/A	0.49	0.57	0.44	0.60	N/A	0.19	N/A	1.09	1.12	1.59	N/A	N/A	N/A	N/A	N/A	0.44	
	1.30	1.68	N/A	N/A	N/A	0.45	0.30	N/A	0.57	0.66	0.53	0.71	N/A	0.22	N/A	1.22	1.30	1.95	N/A	N/A	N/A	N/A	N/A	0.44	
46000	1.45	1.86	N/A	N/A	N/A	0.55	0.34	N/A	0.65	0.75	0.61	0.79	N/A	0.24	N/A	1.22	1.30	1.95	N/A	N/A	N/A	N/A	N/A	0.54	
	1.45	1.86	N/A	N/A	N/A	0.55	0.34	N/A	0.65	0.75	0.61	0.79	N/A	0.24	N/A	1.22	1.30	1.95	N/A	N/A	N/A	N/A	N/A	0.64	

Notes:

1. Static pressure drops of accessory components must be added to external static pressure to enter fan selection tables.
2. Gas heat section maximum temperature rise of 60° F.
3. Throwaway filter option limited to 300 ft/min face velocity.
4. Bag filter option limited to 740 ft/min face velocity.
5. Horizontal roof curbs assume 0.50" static pressure drop or double the standard roof curb pressure drop, whichever is greater.
6. No additional pressure loss for model SXHL.
7. For final filters w/ prefilters (digit 13 = M, N, P, Q) also add pressure drop for throwaway filter.



**Table 58. Component static pressure drops (in. W.G.)—relief damper for return fan**

Nom Tons	Cfm	Relief Damper for Return Fan	Nom Tons	Cfm	Relief Damper for Return Fan
20	4000	0.08	50-55	10000	0.28
	6000	0.19		14000	0.56
	8000	0.35		17000	0.75
	9000	0.44		20000	1.15
	10000	0.55		24000	1.66
	12000	0.79		28000	2.26
25	5000	0.13	60	12000	0.31
	6000	0.19		16000	0.56
	7500	0.30		20000	0.88
	10000	0.55		24000	1.27
	11000	0.67		28000	1.73
	12500	0.85		30000	1.99
30	6000	0.19	70-75	12000	0.31
	9000	0.44		16000	0.56
	12000	0.79		20000	0.88
	14000	1.08		22000	1.05
	15000	1.20		24000	1.27
	17000	1.60		26000	1.47
40	8000	0.18		28000	1.73
	10000	0.28		31000	N/A
	12000	0.41		33000	N/A
	16000	0.73			
	17000	0.82			
	20000	1.15			
	22000	1.39			

## Fan Drive Selections

### Supply Fan Performance

**Table 59. FC supply air fan drive selections — 20 to 75 tons**

Nom Tons	3 Hp		5 Hp		7.5 Hp		10 Hp		15 Hp		20 Hp		25 Hp		30 Hp		40 Hp		50 Hp	
	RPM	Drive No	RPM	Drive No	RPM	Drive No	RPM	Drive No	RPM	Drive No	RPM	Drive No	RPM	Drive No	RPM	Drive No	RPM	Drive No	RPM	Drive No
20	500	5	700	7	900	9	1100	B	1200	C	1400	E								
	600	6	800	8	1000	A	1200	C	1300	D	1500	F								
	700	7	900	9	1100	B	1300	D	1400	E	1600	G								
	800	8	1000	A	1200	C	1400	E	1500	F	1700	H								
	900	9	1100	B	1300	D	1600	G												
25	500	5	700	7	800	8	1000	A	1200	C	1400	E								
	600	6	800	8	900	9	1100	B	1300	D	1500	F								
	700	7	900	9	1000	A	1200	C	1400	E	1600	G								
	800	8	1000	A	1100	B	1300	D	1500	F	1700	H								
	900	9	1100	B	1200	C	1400	E	1600	G										
30			600	6	700	7	800	8	900	9	1100	B								
			700	7	800	8	900	9	1000	A	1200	C								
			800	8	900	9	1000	A	1100	B	1300	D								
			900	9	1000	A	1100	B	1200	C	1400	E								
							1300	D												
40					500	5	700	7	800	8	900	9	1000	A	1000	A				
					600	6	800	8	900	9	1000	A	1100	B	1100	B				
					700	7	900	9	1000	A	1100	B								
					800	8														
50-55					500	5	600	6	700	7	800	8	900	9	1000	A				
					600	6	700	7	800	8	900	9	1000	A	1100	B				
					700	7	800	8	900	9	1000	A	1100	B						
					800	8	900	9	1000	A	1100	B								



## Performance Data

**Table 59. FC supply air fan drive selections — 20 to 75 tons (continued)**

Nom Tons	3 Hp		5 Hp		7.5 Hp		10 Hp		15 Hp		20 Hp		25 Hp		30 Hp		40 Hp		50 Hp			
	RPM	Drive No	RPM	Drive No	RPM	Drive No	RPM	Drive No	RPM	Drive No	RPM	Drive No	RPM	Drive No	RPM	Drive No	RPM	Drive No	RPM	Drive No		
60, 70, 75							400	4	500	5	600	6	700	7	800	8	900	9	1000	A		
							500	5	600	6	700	7	800	8	900	9	1000	A	1100	B		
							600	6	700	7	800	8	900	9	1000	A					1000	A
							700	7	800	8	900	9	1000	A							1100	B

**Table 60. 80%, 100% and 120% wheel width DDP supply air fan speed ranges - 20 to 75 tons**

Nom Tons	DDP Fan Wheel Width	Speed Range (RPM)									
		3 HP	5 HP	7.5 HP	10 HP	15 HP	20 HP	25 HP	30 HP	40 HP	50 HP
20 & 25	80%	1000-1500	1000-1700	1000-2000	1700-2200	1700-2400	1700-2400	N/A	N/A	N/A	N/A
	120%	1000-1300	1000-1500	1000-1800	1000-1900	1700-2200	1700-2400	N/A	N/A	N/A	N/A
20/25 Gas Heat, 30	80%	1000-1200	1000-1500	1000-1700	1000-1900	1700-2100	1700-2200	N/A	N/A	N/A	N/A
	120%	1000-1100	1000-1300	1000-1500	1000-1600	1700-1900	1700-2100	N/A	N/A	N/A	N/A
30 Gas Heat, 40	80%	1000	1000-1200	1000-1400	1000-1600	1000-1800	1700-2000	1700-2000	N/A	N/A	N/A
	120%	N/A	1000-1100	1000-1300	1000-1400	1000-1600	1700-1800	1700-1800	N/A	N/A	N/A
40 Gas Heat 50-55	80%	N/A	1000	1000-1200	1000-1300	1000-1500	1700	1700-1800	1700-1800	N/A	N/A
	100%	N/A	N/A	N/A	N/A	N/A	N/A	1700-1800	1700-1800	N/A	N/A
	120%	N/A	N/A	1000	1000-1200	1000-1300	1400-1500	N/A	1700	N/A	N/A
60	80%	N/A	N/A	N/A	1000-1500	1000-1700	1000-1900	N/A	1700-2100	1700-2200	N/A
	120%	N/A	N/A	N/A	1000-1300	1000-1500	1000-1600	N/A	1700-1900	1700-2100	N/A
70 & 75	80%	N/A	N/A	N/A	1000-1200	1000-1400	1000-1600	N/A	1000-1800	1700-2000	1700-2000
	120%	N/A	N/A	N/A	1000-1100	1000-1300	1000-1400	N/A	1000-1600	1700-1800	1700-1900
60 Gas Heat, 70 & 75 Gas Heat	80%	N/A	N/A	N/A	1000-1300	1000-1400	1000-1600	N/A	1300-1700	1500-1700	N/A
	100%	N/A	N/A	N/A	1000-1100	1000-1200	1000-1300	N/A	1000-1500	NA	N/A

Note: Some rpms will not allow bypass. Please check TOPSS™ on all applications.

**Table 61. Air-cooled supply air fan drive selections — 90 to 130 tons**

RPM	15 HP	20 HP	25 HP	30 HP	40 HP
1000	A	A			
1100	B	B	B		
1200	C	C	C	C	
1300		D	D	D	D
1400			E	E	E
1500			F	F	F
1600				G	G

## Relief Fan Performance

**Table 62. Modulating 100% relief fan performance — 20 to 75 tons**

Nom Tons	CFM Std Air	Negative Static Pressure															
		0.25		0.50		0.75		1.00		1.25		1.50		1.75		2.00	
		RPM	BHP	RPM	BHP	RPM	BHP	RPM	BHP	RPM	BHP	RPM	BHP	RPM	BHP	RPM	BHP
20	4000	379	0.34	515	0.70	622	1.12	712	1.59	791	2.10	861	2.64				
	6000	421	0.61	541	1.03	643	1.52	732	2.07	811	2.66						
	8000	487	1.10	583	1.56	674	2.11	757	2.72								
	10000	567	1.88	643	2.37	719	2.96										
25	4000	379	0.34	515	0.70	622	1.12	712	1.59	791	2.10	861	2.64	927	3.22	988	3.84
	6000	421	0.61	541	1.03	643	1.52	732	2.07	811	2.66	882	3.28	948	3.94	1010	4.64
	8000	487	1.10	583	1.56	674	2.11	757	2.72	834	3.38	904	4.09	970	4.82		
	10000	567	1.88	643	2.37	719	2.96	794	3.63	864	4.35						
	12000	651	2.98	716	3.56	779	4.18	843	4.88								
30	4000	379	0.34	515	0.70	622	1.12	712	1.59	791	2.10	861	2.64	927	3.22	988	3.84
	6000	421	0.61	541	1.03	643	1.52	732	2.07	811	2.66	882	3.28	948	3.94	1010	4.64
	8000	487	1.10	583	1.56	674	2.11	757	2.72	834	3.38	904	4.09	970	4.82	1030	5.59
	10000	567	1.88	643	2.37	719	2.96	794	3.63	864	4.35	931	5.11	993	5.91	1053	6.77
	12000	651	2.98	716	3.56	779	4.18	843	4.88	905	5.64	967	6.47	1026	7.34		
	14000	736	4.47	796	5.17	850	5.83	904	6.57	960	7.38						

**Table 62. Modulating 100% relief fan performance — 20 to 75 tons (continued)**

Nom Tons	CFM Std Air	Negative Static Pressure															
		0.25		0.50		0.75		1.00		1.25		1.50		1.75		2.00	
		RPM	BHP	RPM	BHP	RPM	BHP	RPM	BHP	RPM	BHP	RPM	BHP	RPM	BHP	RPM	BHP
40	7500	318	0.67	444	1.21	545	1.85	629	2.54	702	3.27	767	4.02	828	4.83	884	5.66
	9000	331	0.97	444	1.47	543	2.17	628	2.94	702	3.75	770	4.60	831	5.48	887	6.37
	12000	381	2.13	460	2.40	546	3.04	627	3.89	701	4.83	769	5.82	831	6.87	889	7.93
	14000	422	3.40	486	3.49	557	3.98	631	4.76	701	5.72	768	6.78	830	7.90	888	9.07
	16000	468	5.12	520	5.07	579	5.37	643	6.01	707	6.88	769	7.92	829	9.08	887	10.32
50-55	9000	331	0.97	444	1.47	543	2.17	628	2.94	702	3.75	770	4.60	831	5.48	887	6.37
	12000	381	2.13	460	2.40	546	3.04	627	3.89	701	4.83	769	5.82	831	6.87	889	7.93
	15000	445	4.20	502	4.21	567	4.61	636	5.32	704	6.26	769	7.32	830	8.47	888	9.67
	18000	516	7.41	559	7.19	609	7.32	662	7.76	719	8.49	776	9.44	833	10.56	887	11.79
	20000	566	10.31	602	9.91	644	9.88	690	10.15	739	10.69	789	11.48	841	12.48	893	13.68
60, 70, 75	12000	351	1.49	423	2.09	502	3.00	572	4.02	634	5.07	690	6.09	740	7.04	784	7.91
	15000	412	2.68	460	3.15	521	3.96	585	5.02	646	6.24	702	7.53	749	8.83	801	10.14
	18000	478	4.41	516	4.88	557	5.54	607	6.49	662	7.66	715	9.01	766	10.48	814	12.01
	21000	549	6.75	578	7.36	612	7.92	647	8.71	688	9.77	735	11.03	781	12.46	827	14.03
	24000	617	9.83	644	10.59	672	11.22	702	11.88	732	12.77	766	13.89	805	15.22	846	16.72
27000	688	15.11	711	15.09	736	15.45	761	16.18	788	17.02	815	17.92	844	18.99	876	20.31	

**Notes:**

1. Shaded areas indicate non-standard drive selections. These drive selections must be manually factory selected.
2. Refer to General Data Table for minimum and maximum HP.

**Table 63. Air-cooled modulating 100% relief fan performance — 90 to 130 tons**

Nom Tons	CFM Std Air	Negative Static Pressure									
		0.25		0.50		0.75		1.00		1.25	
		RPM	BHP	RPM	BHP	RPM	BHP	RPM	BHP	RPM	BHP
90-130	28000	495	12.81	519	13.30	547	13.93	582	15.27	619	17.14
	30000	527	15.67	550	16.22	573	16.71	604	17.84	637	19.53
	32000	559	18.92	581	19.53	602	20.03	628	20.90	658	22.39
	34000	591	22.60	612	23.28	632	23.84	653	24.48	681	25.74
	36000	623	26.73	643	27.47	662	28.09	680	28.62	705	29.66
	38000	656	31.34	675	32.14	693	32.83	710	33.42	730	34.17
	40000	688	36.46	707	37.31	724	38.07	741	38.73	757	39.29
	40000	688	36.46	707	37.31	724	38.07	741	38.73	757	39.29
Nom Tons	CFM Std Air	Negative Static Pressure									
		1.50		1.75		2.00		2.25		2.50	
		RPM	BHP	RPM	BHP	RPM	BHP	RPM	BHP	RPM	BHP
90-130	28000	655	18.85	689	20.51	721	22.51	750	24.43	777	26.28
	30000	672	21.63	705	23.38	737	25.16	768	27.31	795	29.37
	32000	690	24.39	723	26.63	753	28.44	784	30.37	811	32.54
	34000	710	27.55	739	29.75	771	32.16	799	34.04	828	36.04
	36000	732	31.25	759	33.29	788	35.76	817	38.26	844	40.23
	38000	755	35.51	780	37.38	806	39.60	834	42.26	861	44.90
	40000	779	40.45	804	42.09	827	44.14	853	46.63	879	49.41
	40000	779	40.45	804	42.09	827	44.14	853	46.63	879	49.41

**Notes:**

1. Shaded areas indicate non-standard drive selections. These drive selections must be manually factory selected.
2. Refer to General Data Table for minimum and maximum HP.

**Table 64. 100% Relief fan drive selections — 20 to 75 tons**

	3 Hp		5 Hp		7.5 Hp		10 Hp		15 Hp		20 Hp	
	RPM	Drive No.	RPM	Drive No.	RPM	Drive No.	RPM	Drive No.	RPM	Drive No.	RPM	Drive No.
20	500	5										
	600	6										
	700	7										
	800	8										
	900	9										
25	500	5	700	7								
	600	6	800	8								
	700	7	900	9								
	800	8	1000	A								
	900	9										
30	500	5	700	7	800	8						
	600	6	800	8	900	9						
	700	7	900	9	1000	A						
	800	8	1000	A	1100	B						
	900	9										



**Performance Data**

**Table 64. 100% Relief fan drive selections — 20 to 75 tons (continued)**

	3 Hp		5 Hp		7.5 Hp		10 Hp		15 Hp		20 Hp	
	RPM	Drive No.	RPM	Drive No.	RPM	Drive No.	RPM	Drive No.	RPM	Drive No.	RPM	Drive No.
40			400	4	600	6	700	7				
			500	5	700	7	800	8				
			600	6	800	8						
			700	7								
			800	8								
50-55			400	4	600	6	700	7	700	7		
			500	5	700	7	800	8	800	8		
			600	6	800	8			900	9		
			700	7								
			800	8								
60			400	4	600	6	600	6	700	7	800	8
70			500	5	700	7	700	7	800	8		
75			600	6								

**Table 65. 100% Relief fan drive selections — 90 to 130 tons**

Nom Tons	15 HP		20 HP		25 HP		30 HP		40 HP	
	RPM	Drive No.	RPM	Drive No.	RPM	Drive No.	RPM	Drive No.	RPM	Drive No.
90-130	500	5	500.00	5	600.00	6	600.00	6	700.00	7
	600	6	600.00	6	700.00	7	700.00	7	800.00	8
			700	7	800	8	800	8		

## Return Fan Performance

**Table 66. Return fan performance—20, 25, 30 ton air-cooled (24.5" Fan)**

CFM Std Air	Return Fan Static Pressure Including Relief Damper P.D.															
	0.25		0.50		0.75		1.00		1.25		1.50		1.75		2.00	
	RPM	BHP	RPM	BHP	RPM	BHP	RPM	BHP	RPM	BHP	RPM	BHP	RPM	BHP	RPM	BHP
4000	557	0.29	638	0.48	710	0.68	776	0.89	838	1.10	899	1.32	969	1.60	1038	1.89
4500	605	0.36	682	0.57	749	0.79	811	1.02	869	1.25	926	1.49	980	1.73	1033	1.99
5000	654	0.44	727	0.67	790	0.91	850	1.16	905	1.41	957	1.67	1007	1.93	1057	2.20
5500	704	0.53	773	0.79	834	1.04	889	1.30	943	1.58	992	1.86	1040	2.15	1087	2.44
6000	756	0.64	821	0.92	879	1.20	932	1.47	982	1.77	1030	2.06	1076	2.38	1121	2.70
6500	808	0.76	868	1.06	925	1.36	976	1.66	1024	1.97	1070	2.29	1114	2.61	1157	2.95
7000	861	0.90	917	1.21	972	1.55	1021	1.87	1067	2.19	1112	2.53	1154	2.87	1195	3.22
7500	913	1.06	968	1.39	1019	1.74	1068	2.10	1112	2.44	1155	2.79	1196	3.15	1235	3.51
8000	967	1.24	1019	1.58	1068	1.96	1115	2.34	1158	2.71	1199	3.08	1238	3.45	1277	3.84
8500	1021	1.44	1071	1.80	1116	2.19	1162	2.60	1204	3.00	1244	3.39	1283	3.79	1320	4.19
9000	1075	1.67	1123	2.04	1166	2.45	1210	2.88	1252	3.30	1290	3.72	1327	4.14	1363	4.56
9500	1130	1.92	1175	2.31	1217	2.73	1258	3.17	1299	3.62	1337	4.07	1373	4.52	1408	4.96
10000	1186	2.20	1228	2.60	1269	3.04	1307	3.50	1347	3.97	1384	4.45	1419	4.91	1454	5.38
10500	1241	2.50	1280	2.92	1321	3.37	1357	3.85	1395	4.34	1432	4.85	1466	5.33	1500	5.84
11000	1297	2.84	1334	3.27	1373	3.74	1409	4.23	1443	4.74	1480	5.26	1515	5.79	1546	6.29
11500	1353	3.20	1387	3.64	1425	4.13	1460	4.64	1493	5.16	1528	5.71	1561	6.25	1594	6.79
12000	1408	3.60	1441	4.06	1477	4.56	1512	5.08	1544	5.62	1576	6.18	1610	6.75	1642	7.32
12500	1464	4.03	1496	4.50	1530	5.01	1565	5.56	1596	6.11	1626	6.68	1658	7.28	1689	7.87
13000	1520	4.49	1551	4.98	1583	5.51	1617	6.06	1648	6.64	1677	7.22	1707	7.84	1737	8.44
13500	1576	4.99	1606	5.50	1636	6.03	1669	6.60	1700	7.20	1728	7.80	1756	8.42	1785	9.06
14000	1633	5.52	1661	6.05	1690	6.60	1721	7.19	1752	7.79	1780	8.42	1807	9.05	1834	9.70

**Notes:**

1. Max fan RPM 1715 for 24.5" Class I Fan
2. Max motors available are as follows: 20T: 3HP, 25; 5HP, 30T: 7.5 HP
3. Max CFM available is as follows; 20T: 9000, 25T: 11000, and 30T: 13500
4. Min CFM is 4000 for 20T, 25T, and 30T
5. Return fan belt drive RPM selections will be available to cover 500-1600 RPM range +/- 50 RPM
6. Performance data includes cabinet and rain hood effect. Damper pressure drop must be added to the return duct static. See table Component static pressure drops - relief damper for return fan in Performance Data.
7. Shaded area indicates nonstandard BHP or RPM selections. Contact a local Trane® representative for more information.

**Table 67. Return fan performance—40, 50 and 55 ton air-cooled (27" Fan)**

CFM Std Air	Return Fan Static Pressure Including Relief Damper P.D.															
	0.25		0.50		0.75		1.00		1.25		1.50		1.75		2.00	
	RPM	BHP	RPM	BHP	RPM	BHP	RPM	BHP	RPM	BHP	RPM	BHP	RPM	BHP	RPM	BHP
7500	709	0.82	766	1.16	815	1.50	861	1.85	906	2.22	949	2.60	991	2.99	1033	3.39
8000	748	0.95	803	1.31	851	1.67	895	2.04	938	2.43	979	2.82	1018	3.22	1058	3.64
8500	788	1.09	840	1.47	887	1.86	930	2.24	971	2.64	1010	3.05	1049	3.48	1087	3.92
9000	827	1.24	878	1.64	924	2.05	965	2.46	1005	2.88	1043	3.31	1080	3.75	1115	4.19
9500	867	1.41	916	1.83	961	2.27	1001	2.70	1040	3.14	1076	3.58	1112	4.03	1146	4.50
10000	908	1.60	955	2.04	999	2.50	1038	2.95	1075	3.41	1111	3.88	1145	4.34	1179	4.83
10500	948	1.81	994	2.27	1036	2.75	1075	3.23	1111	3.70	1145	4.18	1179	4.68	1212	5.18
11000	989	2.04	1033	2.51	1074	3.01	1112	3.51	1147	4.01	1181	4.51	1213	5.02	1245	5.53
11500	1030	2.28	1072	2.78	1112	3.29	1149	3.82	1184	4.33	1216	4.86	1248	5.38	1279	5.92
12000	1071	2.55	1112	3.06	1151	3.59	1187	4.14	1221	4.69	1253	5.24	1284	5.78	1314	6.33
12500	1112	2.83	1152	3.37	1189	3.92	1225	4.48	1258	5.06	1290	5.62	1320	6.19	1349	6.76
13000	1153	3.14	1192	3.70	1228	4.27	1263	4.86	1296	5.45	1327	6.04	1356	6.63	1385	7.23
13500	1194	3.47	1232	4.05	1267	4.63	1301	5.24	1333	5.85	1364	6.47	1393	7.08	1421	7.70
14000	1236	3.83	1272	4.42	1307	5.03	1340	5.66	1371	6.29	1401	6.94	1430	7.57	1457	8.20
14500	1277	4.21	1313	4.82	1346	5.45	1379	6.10	1410	6.75	1439	7.42	1467	8.08	1494	8.73
15000	1319	4.62	1353	5.25	1386	5.90	1417	6.55	1448	7.23	1477	7.92	1504	8.61	1531	9.29
15500	1361	5.05	1394	5.71	1426	6.37	1457	7.05	1486	7.74	1514	8.44	1542	9.16	1569	9.87
16000	1402	5.51	1435	6.18	1466	6.87	1496	7.57	1525	8.28	1553	9.01	1580	9.74	1606	10.47
16500	1444	6.00	1476	6.69	1506	7.40	1535	8.12	1564	8.85	1591	9.58	1617	10.34	1643	11.10
17000	1486	6.52	1517	7.23	1547	7.96	1575	8.70	1603	9.44	1629	10.20	1655	10.97	1681	11.75
17500	1528	7.07	1558	7.80	1587	8.55	1615	9.30	1642	10.07	1668	10.85	1694	11.64	1718	12.43
18000	1570	7.65	1599	8.40	1627	9.17	1655	9.94	1681	10.73	1707	11.53	1732	12.33	1757	13.15
18500	1612	8.26	1640	9.03	1668	9.81	1695	10.62	1721	11.43	1746	12.23	1771	13.07	1794	13.89
19000	1654	8.91	1682	9.70	1709	10.50	1735	11.31	1760	12.14	1785	12.97	1809	13.82	1833	14.67
19500	1696	9.59	1723	10.40	1749	11.22	1775	12.06	1800	12.90	1825	13.76	1848	14.62	1872	15.50



## Performance Data

**Table 67. Return fan performance—40, 50 and 55 ton air-cooled (27" Fan) (continued)**

CFM Std Air	Return Fan Static Pressure Including Relief Damper P.D.															
	0.25		0.50		0.75		1.00		1.25		1.50		1.75		2.00	
	RPM	BHP	RPM	BHP	RPM	BHP	RPM	BHP	RPM	BHP	RPM	BHP	RPM	BHP	RPM	BHP
20000	1738	10.30	1765	11.13	1790	11.97	1816	12.83	1840	13.69	1864	14.56	1888	15.46	1910	16.34
20500	1780	11.05	1806	11.90	1831	12.76	1856	13.63	1880	14.52	1903	15.41	1926	16.31	1949	17.22
21000	1822	11.84	1848	12.71	1872	13.59	1897	14.48	1920	15.39	1943	16.29	1966	17.23	1988	18.14
21500	1864	12.66	1889	13.55	1914	14.45	1937	15.36	1960	16.29	1983	17.22	2005	18.16	2027	19.11
22000	1899	13.05	1926	14.11	1952	15.16	1977	16.20	2001	17.23	2024	18.24	2047	19.27	2069	20.28
22500	1941	13.91	1967	14.98	1992	16.05	2017	17.12	2041	18.19	2064	19.23	2086	20.27	2108	21.31

**Notes:**

1. Max fan RPM 1981 For 27" Class II Fan
2. Max Motor Available 15 HP For 27" Fan Size
3. Max motors Available are as follows: 40T: 10 HP & 50-55T: 15 HP
4. Max CFM is as follows: 40T: 18000, 50-55T: 22500
5. Min CFM is as follows: 40T: 7500, 50-55T: 9000
6. Return fan belt drive RPM selections will be available to cover 700-1900 RPM range +/- 50 RPM
7. Performance data includes cabinet and rain hood effect. Damper pressure drop must be added to the return duct static. See table Component static pressure drops - relief damper for return fan in Performance Data.
8. Shaded area indicates nonstandard BHP or RPM selections. Contact a local Trane® representative for more information.

**Table 68. Return fan performance—60 to 75 tons air-cooled (36.5" fan)**

CFM Std Air	Return Fan Static Pressure Including Relief Damper P.D.															
	0.25		0.50		0.75		1.00		1.25		1.50		1.75		2.00	
	RPM	BHP	RPM	BHP	RPM	BHP	RPM	BHP	RPM	BHP	RPM	BHP	RPM	BHP	RPM	BHP
12000	459	1.07	502	1.59	541	2.13	578	2.71	613	3.31	647	3.91	681	4.54	713	5.20
13000	490	1.27	530	1.83	567	2.40	603	3.01	636	3.65	668	4.29	700	4.94	731	5.64
14000	520	1.49	560	2.09	595	2.70	628	3.34	660	3.99	691	4.69	721	5.38	751	6.10
15000	552	1.73	590	2.38	623	3.03	655	3.70	686	4.39	715	5.11	744	5.85	771	6.59
16000	583	2.00	619	2.70	652	3.39	682	4.09	712	4.82	740	5.57	767	6.34	794	7.14
17000	615	2.30	650	3.05	681	3.78	710	4.52	739	5.28	766	6.06	792	6.85	818	7.67
18000	646	2.64	680	3.43	711	4.20	739	4.98	766	5.78	792	6.60	817	7.41	842	8.27
19000	678	3.01	711	3.85	741	4.67	768	5.48	794	6.31	819	7.16	844	8.03	867	8.89
20000	711	3.42	742	4.30	771	5.17	797	6.02	823	6.90	847	7.77	871	8.66	894	9.59
21000	743	3.87	773	4.78	801	5.70	827	6.60	852	7.51	875	8.41	898	9.36	920	10.30
22000	775	4.36	805	5.31	832	6.28	857	7.22	881	8.17	904	9.11	926	10.09	947	11.06
23000	808	4.89	836	5.88	863	6.90	887	7.89	911	8.88	933	9.87	954	10.86	975	11.88
24000	840	5.46	868	6.49	894	7.56	918	8.60	941	9.63	962	10.67	983	11.71	1004	12.75
25000	873	6.08	900	7.15	925	8.26	948	9.35	970	10.42	992	11.49	1012	12.59	1032	13.67
26000	906	6.75	931	7.86	956	9.00	979	10.16	1001	11.28	1021	12.37	1041	13.49	1061	14.63
27000	939	7.47	963	8.62	987	9.79	1010	11.01	1031	12.18	1052	13.33	1071	14.47	1090	15.65

**Notes:**

1. Max fan RPM 1151 for 36.5" Class I Fan
2. Max motor available 20 HP for 36.5" fan size
3. Max motor available 20 HP for 60, 70, and 75T
4. Max CFM is 27000 for 60, 70, and 75T
5. Min CFM is 12000 for 60, 70, and 75T
6. Return fan belt drive RPM selections will be available to cover 500-1100 RPM range +/- 50 RPM
7. Performance data includes cabinet and rain hood effect. Damper pressure drop must be added to the return duct static. See table Component static pressure drops - relief damper for return fan in Performance Data.

**Table 69. 100% Return fan drive selections — 20 to 75 tons air-cooled**

	3 Hp		5 Hp		7.5 Hp		10 Hp		15 Hp		20 Hp	
	RPM	Drive No.	RPM	Drive No.	RPM	Drive No.	RPM	Drive No.	RPM	Drive No.	RPM	Drive No.
20	500	5										
	600	6										
	700	7										
	800	8										
	900	9										
	1000	A										
	1100	B										
25	1200	C										
	1300	D										
	500	5	1100	B								
	600	6	1200	C								
	700	7	1300	D								
	800	8	1400	E								
	900	9	1500	F								
30	1000	A	1600	G								
	1100	B										
	1200	C										
	1300	D										
	500	5	1100	B	1400	E						
	600	6	1200	C	1500	F						
	700	7	1300	D	1600	G						
40	800	8	1400	E								
	900	9	1500	F								
	1000	A										
	1100	B										
	1200	C										
	1300	D										
	50-55	700	7	1200	C	1400	E	1600	G			
800		8	1300	D	1500	F	1700	H				
900		9	1400	E	1600	G	1800	J				
1000		A	1500	F	1700	H	1900	K				
1100		B										
1200		C										
1300		D										
60	500	5	700	7	800	8	900	9	1100	B		
	600	6	800	8	900	9	1000	A				
	700	7	900	9	1000	A						
	800	8										
70, 75	500	5	700	7	800	8	900	9	1100	B		
	600	6	800	8	900	9	1000	A				
	700	7	900	9	1000	A						
	800	8										



# Electrical Data

## Electrical Service Sizing

To correctly size electrical service wiring for a unit, find the appropriate calculations listed below. Each type of unit has its own set of calculations for MCA (Minimum Circuit Ampacity) and MOP (Maximum Overcurrent Protection). Read the load definitions that follow and then find the appropriate set of calculations based on unit type.

**Note:** Set 1 is for cooling only, cooling with gas heat, or cooling with hot water/steam heat units. Set 2 is for cooling with electric heat units

Load Definitions: (To determine load values, see the Electrical Service Sizing Data Tables on the following page.)

LOAD1 = Current of the largest motor (compressor or fan motor)

LOAD2 = Sum of the currents of all remaining motors

LOAD3 = Current of electric heaters

LOAD4 = Any other load rated at 1 AMP or more

SAH\_ (Cooling Only) units

SEH\_ (Cooling with Electric Heat) units

SXH\_ (Extended Casing Cooling Only) units

SLH\_ and SSH\_ (Cooling with Hydronic Heat) units

SFH\_ (Cooling with Gas Heat) units

Load Definitions	
LOAD 1	Current (RLA, MRC, FLA or MOC) of the largest motor (compressor or fan motor)
LOAD 2	Sum of the currents (RLA, MRC, FLA or MOC) of all remaining motors
LOAD 3	Current of electric heaters
LOAD 4	Any other load rated at 1 amp or more

Load 4 — Control Power Transformer Loads for All Modes				
	200V	230V	460V	575V
20–75 ton units	10.0 Amps	9.0 Amps	4.5 Amps	3.5 Amps
90–130 ton units	—	—	9.0 Amps	7.0 Amps

### Set 1: Cooling Only Rooftop Units and Cooling with Gas Heat or Hydronic Heat Rooftop Units

$$MCA = (1.25 \times \text{LOAD1}) + \text{LOAD2} + \text{LOAD4}$$

$$MOP = (2.25 \times \text{LOAD1}) + \text{LOAD2} + \text{LOAD4}$$

Select a fuse rating equal to the MOP value. If the MOP value does not equal a standard fuse size as listed in NEC 240-6, select the next lower standard fuse rating.

**Note:** If selected MOP is less than the MCA, then select the lowest standard maximum fuse size which is equal to or larger than the MCA, provided the selected fuse size does not exceed 800 amps.

### Set 2: Rooftop units with Electric Heat

#### Single Source Power units (460V and 575V)

To arrive at the correct MCA and MOP values for these units, two sets of calculations must be performed. First calculate the MCA and MOP values as if the unit was in cooling mode (use the equations given in Set 1). Then calculate the MCA and MOP values as if the unit were in heating mode as follows. (Keep in mind when determining LOADS that the compressors do not run while the unit is in heating mode).



For units using heaters less than 50 kW:

$$\text{MCA} = 1.25 \times (\text{LOAD1} + \text{LOAD2} + \text{LOAD4}) + (1.25 \times \text{LOAD3})$$

For units using heaters equal to or greater than 50 kW:

$$\text{MCA} = 1.25 \times (\text{LOAD1} + \text{LOAD2} + \text{LOAD4}) + \text{LOAD3}$$

The nameplate MCA value will be the larger of the cooling mode MCA value or the heating mode MCA value calculated above.

$$\text{MOP} = (2.25 \times \text{LOAD1}) + \text{LOAD2} + \text{LOAD3} + \text{LOAD4}$$

The selection MOP value will be the larger of the cooling mode MOP value or the heating mode MOP value calculated above.

Select a fuse rating equal to the MOP value. If the MOP value does not equal a standard fuse size as listed in NEC 240-6, select the next lower standard fuse rating.

**Note:** *If selected MOP is less than the MCA, then select the lowest standard maximum fuse size which is equal to or larger than the MCA, provided the selected fuse size does not exceed 800 amps.*

#### **Dual Source Power units (200–230V with Electric Heat)**

These units will have two circuit values shown on the nameplate. The first circuit value will be the refrigeration (cooling mode) values calculated per Set 1. The second set of circuit values shown on the nameplate will be for the electric heating circuit as follows.

$$\text{MCA} = (1.25 \times \text{LOAD3})$$

$$\text{MOP} = (1.25 \times \text{LOAD3})$$

Select a fuse rating for the electric heating circuit that is equal to the MOP value obtained in the equation above. If the MOP value does not equal a standard fuse size as listed in NEC 240-6, select the next lower standard fuse rating (see note below for exception).

**Note:** *If the available MOP option is less than the MCA obtained in the equation above, then reselect the lowest standard maximum fuse size which is equal to, or larger, than the MCA, provided the reselected fuse size does not exceed 800 amps.*



**Electrical Data**

**Service Sizing Data**

**Table 70. Compressor electrical service sizing data (20 to 130 tons)**

Tonnage	No. of Compressors	200 V		230 V		460 V		575 V	
		RLA/MRC <sup>(a)</sup> (ea.)	LRA (ea.)	RLA/MRC <sup>(a)</sup> (ea.)	LRA (ea.)	RLA/MRC <sup>(a)</sup> (ea.)	LRA (ea.)	RLA/MRC <sup>(a)</sup> (ea.)	LRA (ea.)
20 Variable Speed	1 <sup>(b)</sup> 1	47.7	N/A	41.4	N/A	20.7	N/A	16.6	N/A
		40.3	267	40.3	267	19.1	142	15.8	103
25 Standard	1	27.8	203	27.7	203	14.5	98	12.5	84
	2	40.3	267	40.3	267	19.1	142	15.8	103
25 High Efficiency	1	59.6	386	51.8	386	25.9	182	20.7	131
	1	38.5	255	33.5	255	16.7	140	13.4	108
25 Variable Speed	1 <sup>(b)</sup> 1	52.7	N/A	45.9	N/A	22.9	N/A	18.3	N/A
		46.0	304	42.3	304	21.8	147	17.2	103
30 Standard	1	27.8	203	27.7	203	14.5	98	12.5	84
	2	45.0	304	42.3	304	20.6	142	17.2	122
30 High Efficiency	1	27.8	203	27.7	203	14.5	98	12.5	84
	2	40.3	267	40.3	267	19.1	142	15.8	103
30 Variable Speed	1 <sup>(b)</sup> 1	57.6	N/A	50.4	N/A	25.6	N/A	20.1	N/A
		52.4	315	47.9	315	24	158	19.2	136
40 Standard	2	38.0	267	34.8	267	17.8	142	15.2	103
	2	40.3	267	40.3	267	19.1	142	15.8	103
40 High Efficiency	2	30.0	203	28.4	203	14.5	98	11.9	84
	2	38.0	267	34.8	267	17.8	142	15.2	103
40 Variable Speed	1 <sup>(b)</sup> 2	57.6	N/A	50.4	N/A	25.6	N/A	20.1	N/A
		40.3	267	40.3	267	19.1	142	15.8	103
50 Standard	2	40.3	267	40.3	267	19.1	142	15.8	103
	2	46.0	304	42.3	304	21.8	147	17.2	122
50 High Efficiency	1	40.3	267	40.3	267	19.1	142	15.8	103
	3	46.0	304	42.3	304	21.8	147	17.2	122
50 Variable Speed	1 <sup>(b)</sup> 2	79.4	N/A	73.1	N/A	36.5	N/A	29.2	N/A
		46.0	304	42.3	304	21.8	147	17.2	122
55 Standard	1	46.0	304	42.3	304	21.8	147	17.2	122
	3	52.4	315	47.9	315	24.0	158	19.2	136
55 High Efficiency	3	46.0	304	42.3	304	21.8	147	17.2	122
	1	52.4	315	47.9	315	24.0	158	19.2	136
55 Variable Speed	1 <sup>(b)</sup> 2	83.6	N/A	73.1	N/A	36.5	N/A	29.2	N/A
		52.4	315	47.9	315	24.0	158	19.2	136
60 Standard	3	52.4	315	47.9	315	24.0	158	19.2	136
	1	59.8	345	54.8	345	27.4	155	23.1	126
60 High Efficiency	2	52.4	315	47.9	315	24.0	158	19.2	136
	2	59.8	345	54.8	345	27.4	155	23.1	126
60 Variable Speed	1 <sup>(b)</sup> 1	86.8	N/A	75.5	N/A	37.7	N/A	30.2	N/A
		52.4	315	47.9	315	24.0	158	19.2	136
70 Standard	1	59.8	345	54.8	345	27.4	155	23.1	126
	1	56.5	308	51.5	308	25.0	160	20.8	135
70 High Efficiency	4	78.8	528	69.8	528	34.9	215	27.9	175
	1	59.8	345	54.8	345	27.4	155	23.1	126
70 Variable Speed	1 <sup>(b)</sup> 2	91.3	N/A	79.4	N/A	39.7	N/A	31.8	N/A
		76.2	528	69.3	528	33.7	215	27.1	175
75 Standard	2	56.5	308	51.5	308	25.0	160	20.8	135
	2	78.8	528	69.8	528	34.9	215	27.9	175
75 High Efficiency	1	56.5	308	51.5	308	25.0	160	20.8	135
	3	78.8	528	69.8	528	34.9	215	27.9	175
75 Variable Speed	1 <sup>(b)</sup> 1	94.0	N/A	81.7	N/A	40.9	N/A	33.1	N/A
		56.5	308	51.5	308	25.0	160	20.8	135
	2	59.8	345	54.8	345	27.4	155	23.1	126

**Table 70. Compressor electrical service sizing data (20 to 130 tons) (continued)**

Tonnage	No. of Compressors	200 V		230 V		460 V		575 V	
		RLA/MRC <sup>(a)</sup> (ea.)	LRA (ea.)	RLA/MRC <sup>(a)</sup> (ea.)	LRA (ea.)	RLA/MRC <sup>(a)</sup> (ea.)	LRA (ea.)	RLA/MRC <sup>(a)</sup> (ea.)	LRA (ea.)
90 Standard and High Efficiency	4	N/A	N/A	N/A	N/A	34.9	215	27.9	175
105 Standard	2	N/A	N/A	N/A	N/A	34.9	215	27.9	175
	2	N/A	N/A	N/A	N/A	47.5	260	35.6	210
115 Standard	1	N/A	N/A	N/A	N/A	34.9	215	27.9	175
	3	N/A	N/A	N/A	N/A	47.5	260	35.6	210
130 Standard	2	N/A	N/A	N/A	N/A	47.5	260	35.6	210
	2	N/A	N/A	N/A	N/A	53.5	320	42.9	235

<sup>(a)</sup> RLA (Rated Load Amps) applies to fixed speed compressors; MRC (Max Rated Current) applies to variable speed compressors.

<sup>(b)</sup> Variable Speed Compressor.

**Table 71. Electrical service sizing data — condenser fan motors — 20 to 130 tons**

Tonnage, Type	No. of Motors	200 V	230 V	460 V	575 V
		FLA/MOC <sup>(a)</sup> (ea.)	FLA/MOC <sup>(a)</sup> (ea.)	FLA/MOC <sup>(a)</sup> (ea.)	FLA/MOC <sup>(a)</sup> (ea.)
20S, 20H	2	5.4	5.4	2.7	2.2
20S, 20H Low Ambient	1	5.4	5.4	2.7	2.2
	1 <sup>(b)</sup>	4.4	4.4	2.1	2.0
20V	2 <sup>(b)</sup>	4.4	4.4	2.1	2.0
25S	2	5.4	5.4	2.7	2.2
25S Low Ambient	1	5.4	5.4	2.7	2.2
	1 <sup>(b)</sup>	4.4	4.4	2.1	2.0
25H, 25V	2 <sup>(b)</sup>	4.4	4.4	2.1	2.0
30S, 30H	2	5.4	5.4	2.7	2.2
30S, 30H Low Ambient	1	5.4	5.4	2.7	2.2
	1 <sup>(b)</sup>	4.4	4.4	2.1	2.0
30V	2 <sup>(b)</sup>	4.4	4.4	2.1	2.0
40S	4	5.4	5.4	2.7	2.2
40S Low Ambient	2	5.4	5.4	2.7	2.2
	2 <sup>(b)</sup>	4.4	4.4	2.1	2.0
40H, 40V	4 <sup>(b)</sup>	4.4	4.4	2.1	2.0
50S, 55S	4	5.4	5.4	2.7	2.2
50S, 55S Low Ambient	2	5.4	5.4	2.7	2.2
	2 <sup>(b)</sup>	4.4	4.4	2.1	2.0
50H, 50V, 55H, 55V	4 <sup>(b)</sup>	4.4	4.4	2.1	2.0
60S, 60H, 70S, 70H, 75S, 75H	6	4.4	4.4	2.2	1.5
60S, 60H, 70S, 70H, 75S, 75H Low Ambient	4	4.4	4.4	2.2	1.5
	2 <sup>(b)</sup>	3.0	3.0	1.5	1.4
60V, 70V, 75V	6 <sup>(b)</sup>	3.0	3.0	1.5	1.4
90S	8	N/A	N/A	2.2	1.5
90S Low Ambient	6	N/A	N/A	2.2	1.5
	2 <sup>(b)</sup>	N/A	N/A	2.2	1.5
90H, 105S, 115S	10	N/A	N/A	2.2	1.5
90H, 105S, 115S Low Ambient	8	N/A	N/A	2.2	1.5
	2 <sup>(b)</sup>	N/A	N/A	2.2	1.5
130S	12	N/A	N/A	2.2	1.5
130S Low Ambient	10	N/A	N/A	2.2	1.5
	2 <sup>(b)</sup>	N/A	N/A	2.2	1.5

<sup>(a)</sup> FLA (Full Load Amps) applies to fixed speed motors; MOC (Max Operating Current) applies to variable speed motors.

<sup>(b)</sup> Variable speed motor.

**Table 72. Electrical service sizing data — supply/relief/return motors WITH bypass option — 20 to 130 tons**

	200 V	230 V	460 V	575 V
	FLA (ea.)	FLA (ea.)	FLA (ea.)	FLA (ea.)
<b>Motor Horsepower</b>	<b>Supply/Relief/Return Fan Motor (4 pole)</b>			
3	9.7	8.4	4.2	3.4
5	15.3	13.2	6.6	5.3



## Electrical Data

**Table 72. Electrical service sizing data — supply/relief/return motors WITH bypass option — 20 to 130 tons (continued)**

	200 V	230 V	460 V	575 V
	FLA (ea.)	FLA (ea.)	FLA (ea.)	FLA (ea.)
7.5	22.8	19.6	9.8	7.8
10	29.5	25.2	12.6	10.1
15	43.0	36.0	18.0	15.0
20	56.1	49.4	24.7	19.5
25	72.0	61.0	30.5	24.8
30	84.0	73.2	36.6	29.0
40	N/A	N/A	49.0	39.0
50	N/A	N/A	59.0	47.2
<b>Motor Horsepower</b>	<b>Supply Fan Motor (6 pole)</b>			
3	10.1	9.0	4.5	3.6
5	17.0	14.8	7.4	5.6
7.5	25.0	22.0	11.0	9.0
10	32.0	28.6	14.3	11.9
15	47.0	41.0	20.5	16.3
20	63.0	54.0	27.0	20.8

**Notes:**

1. FLA is for individual motors by HP, not total unit supply fan HP.
2. Return fan motors are available in 3-20 Hp
3. 40 and 50 Hp motor available as standard in 460 and 575 volt only
4. DDP fans selected under 1,700 RPM will have 6-pole motors
5. 60-75T units with DDP supply fan motors have 1 VFD and 2 motors.
6. 90-130T units have 2 VFDs and 2 motors.

**Table 73. Electrical service sizing data — single supply/relief/return motors WITHOUT bypass option — 20 to 130 tons**

	200 V	230 V	460 V	575 V
	MOC (ea.)	MOC (ea.)	MOC (ea.)	MOC (ea.)
<b>Motor Horsepower</b>	<b>Supply/Relief/Return Fan Motor (4 pole)</b>			
3	8.8	7.6	3.8	3.1
5	13.9	12.0	6.0	4.8
7.5	20.7	17.8	8.9	7.1
10	26.8	22.9	11.5	9.2
15	39.1	32.7	16.4	13.6
20	51.0	44.9	22.5	17.7
25	65.5	55.5	27.7	22.5
30	76.4	66.5	33.3	26.4
40	N/A	N/A	44.5	35.5
50	N/A	N/A	53.6	42.9
<b>Motor Horsepower</b>	<b>Supply Fan Motor (6 pole)</b>			
3	9.2	8.2	4.1	3.3
5	15.5	13.5	6.7	5.1
7.5	22.7	20.0	10.0	8.2
10	29.1	26.0	13.0	10.8
15	42.7	37.3	18.6	14.8
20	57.3	49.1	24.5	18.9

**Notes:**

1. MOC (Max Operating Current) is VFD Input Current when fan motor is operating at FLA
2. MOC is for individual motors by HP, not total unit supply fan HP.
3. Return fan motors are available in 3-20 Hp.
4. 40 and 50 Hp motor available as standard in 460 and 575 volt only.
5. DDP fans selected under 1,700 RPM will have 6-pole motors.
6. 90-130T units have 2 VFDs and 2 motors.

**Table 74. Electrical service sizing data — dual DDP supply fan motors WITHOUT bypass option — 60 to 75 tons**

	200 V	230 V	460 V	575 V
	MOC	MOC	MOC	MOC
<b>Motor Horsepower</b>	<b>2x Supply Fan Motors (4 pole)</b>			
2x 7.5HP	41.5	35.6	17.8	14.2
2x 10HP	53.6	45.8	22.9	18.4
2x 15HP	78.2	65.5	32.7	27.3
2x 20HP	N/A	N/A	44.9	35.5
2x 25HP	N/A	N/A	55.5	45.1
<b>Motor Horsepower</b>	<b>2x Supply Fan Motors (6 pole)</b>			
2x 5HP	30.9	26.9	13.5	10.2
2x 7.5HP	45.5	40.0	20.0	16.4

**Table 74. Electrical service sizing data — dual DDP supply fan motors WITHOUT bypass option — 60 to 75 tons (continued)**

	200 V	230 V	460 V	575 V
	MOC	MOC	MOC	MOC
2x 10HP	58.2	52.0	26.0	21.6
2x 15HP	85.5	74.5	37.3	29.6
2x 20HP	N/A	N/A	49.1	37.8

**Notes:**

1. MOC (Max Operating Current) is VFD Input Current when fan motors are operating at FLA
2. MOC for dual DDP supply fans without bypass represents the total VFD input current for both supply fan motors.
3. Dual DDP fans selected under 1,700 RPM will have 6-pole motors

**Table 75. Electrical service sizing data —electric heat module (electric heat units only) — 20 to 130 tons**

Module kW	Electric Heat FLA			
	200V	230V	460V	575V
30	83.3	72.2	36.1	28.9
50	138.8	120.3	60.1	48.1
70	194.3	168.4	84.2	67.4
90	249.8	216.5	108.3	86.6
110	305.3	264.6	132.3	105.9
130	-	-	156.4	125.1
150	-	-	180.4	144.3
170	-	-	204.5	163.6
190	-	-	228.5	182.8

**Note:** Electric heat FLA are determined at 208, 240, 480 and 600 volts.

**Table 76. Voltage utilization range**

Unit Voltage	Voltage Utilization Range
200/60/3	180-220
230/60/3	207-253
460/60/3	414-506
575/60/3	517-633



# Dimensional Data

Figure 35. Heating/cooling unit dimensions - 20 to 75 tons air-cooled

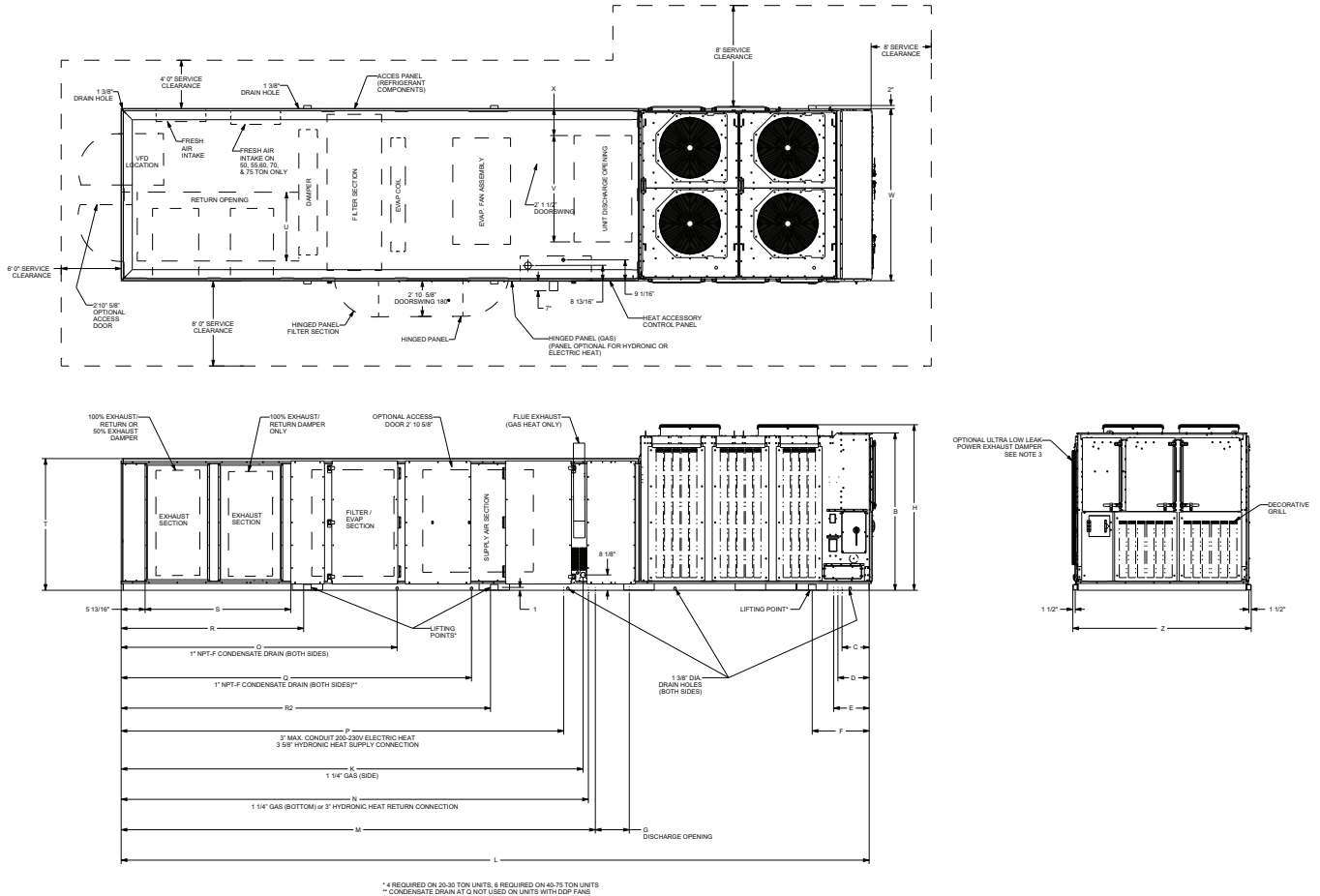

Table 77. Heating/cooling unit dimensions (ft. in.) - air-cooled - SEH\_, SFH\_, SSH\_, SLH\_, SXH\_

Nom. Tons	H	L	W	B	C	D	E	F	G
20, 25	7-3	24-1 3/8	7-6 1/2	6-9	0-9 1/2	1-3 5/8	1-7 9/16	1-3 1/2	2-2 1/2
30	7-3	24-1 3/8	7-6 1/2	6-9	0-9 1/2	1-3 5/8	1-7 9/16	1-3 1/2	2-2 1/2
40	7-3	32-10 1/2	7-6 1/2	6-9	0-9 7/8	1-5 7/8	1-10 1/8	2-5	2-5
50, 55	7-3	32-10 1/2	7-6 1/2	6-9	0-9 7/8	1-5 7/8	1-10 1/8	2-5	2-5
60	7-3 1/4	32-10 1/2	9-8	6-9	0-9 7/8	1-5 7/8	1-10 1/8	2-5	2-5
70, 75	7-3 1/4	32-10 1/2	9-8	6-9	0-9 7/8	1-5 7/8	1-10 1/8	2-5	2-5
Nom. Tons	J	K	M	N	O	P	Q	R	R2
20, 25	16-9 3/4	16-6	16-3 13/16	16-7	10-7	15-5 5/16	13-3	7-0	N/A
	16-9 3/4	16-6							
30	16-9 3/4	16-6	16-3 13/16	16-7	10-7	18-11 11/16	15-4 15/16	8-0	N/A
	16-9 3/4	16-6							
40	20-1 3/4	19-6	19-10 5/16	19-7	12-1	18-11 11/16	15-4 15/16	8-0	16-2 5/16
	20-6 3/4	20-3							
50, 55	20-1 3/4	19-6	19-10 5/16	19-7	12-1	15-5 5/16	13-3	7-0	16-2 5/16
	20-6 3/4	20-3							
60	20-1 3/4	19-6	19-10 5/16	19-7	12-1	18-11 11/16	15-4 15/16	8-0	16-2 5/16
	20-6 3/4	20-3							
70, 75	20-1 3/4	19-6	19-10 5/16	19-7	12-1	18-11 11/16	15-4 15/16	8-0	16-2 5/16
	20-6 3/4	20-3							

**Table 77. Heating/cooling unit dimensions (ft. in.) - air-cooled - SEH\_, SFH\_, SSH\_, SLH\_, SXH\_ (continued)**

Nom. Tons	S		T	U		V	X	Z
	w/Exh Fan	w/ Ret Fan		w/Exh Fan	w/ Ret Fan			
20, 25	6-6 15/16	3-0	3-9 5/16	3-4 3/8	2-9 15/16	5-7	0-5 13/16	7-9 1/2
30	6-6 15/16	3-0	4-9 5/16	3-4 3/8	2-9 15/16	5-7	0-5 13/16	7-9 1/2
40	7-8 3/16	3-4	5-9 5/16	3-4 3/8	3-1 1/2	5-7	0-5 13/16	7-9 1/2
50, 55	7-8 3/16	3-4	6-9 3/8	3-4 3/8	3-1 1/2	5-7	0-5 13/16	7-9 1/2
60	7-8 3/16	4-5	5-9 5/16	4-5 3/8	4-2 1/2	7-8 1/2	0-5 13/16	9-11
70, 75	7-8 3/16	4-5	5-9 5/16	4-5 3/8	4-2 1/2	7-8 1/2	0-5 13/16	9-11

**Notes:**

1. In columns J and K: top dimension = high gas heat, bottom dimension = low gas heat.
2. Unit drawing is representative only and may not accurately depict all models.
3. Use high gas heat J dimension for all hydronic heat connections.
4. Optional Ultra Low Leak Power Exhaust extends beyond lifting lug and increases overall "Z" dimension by 0.65".

**Table 78. Cooling only unit dimensions (ft. in.) - SAHP**

Nom. Tons	H	L	W	B	C	D	E	F	G	J	K
20, 25	7-3	21-9 3/4	7-6 1/2	6-9	0-9 1/2	1-3 5/8	1-7 9/16	1-3 1/2	2-2 1/2	14-0 1/4	12-6
30	7-3	21-9 3/4	7-6 1/2	6-9	0-9 1/2	1-3 5/8	1-7 9/16	1-3 1/2	2-2 1/2	14-0 1/4	12-6
40	7-3	29-8	7-6 1/2	6-9	0-9 7/8	1-5 7/8	1-10 1/8	2-5	2-5	16-7 13/16	15-4 15/16
50, 55	7-3	29-8	7-6 1/2	6-9	0-9 1/2	1-5 7/8	1-10 1/8	2-5	2-5	16-7 13/16	15-4 15/16
60	7-3 1/4	29-8	9-8	6-9	0-9 7/8	1-5 7/8	1-10 1/8	2-5	2-5	16-7 13/16	15-4 15/16
70, 75	7-3 1/4	29-8	9-8	6-9	0-9 7/8	1-5 7/8	1-10 1/8	2-5	2-5	16-7 13/16	15-4 15/16

Nom. Tons	M	M2	N		O	P	Q		R	S	U
			w/Exh Fan	w/ Ret Fan			w/Exh Fan	w/ Ret Fan			
20, 25	7-0	N/A	6-6 15/16	3	10-7	3-9 5/16	3-4 3/8	2-9 15/16	5-7	0-11 3/4	7-9 1/2
30	7-0	N/A	6-6 15/16	3	10-7	4-9 5/16	3-4 3/8	2-9 15/16	5-7	0-11 3/4	7-9 1/2
40	8-0	16-2 5/16	7-8 3/16	3 - 4	12-1	5-9 5/16	3-4 3/8	3 - 1 1/2"	5-7	0-11 3/4	7-9 1/2
50, 55	8-0	16-2 5/16	7-8 3/16	3 - 4	12-1	6-9 3/8	3-4 3/8	3 - 1 1/2"	5-7	0-11 3/4	7-9 1/2
60	8-0	16-2 5/16	7-8 3/16	4 - 5	12-1	5-9 5/16	4-5 3/8	4 - 2 1/2"	6-10 7/8	1-4 9/16	9-11
70, 75	8-0	16-2 5/16	7-8 3/16	4 - 5	12-1	5-9 5/16	4-5 3/8	4 - 2 1/2"	6-10 7/8	1-4 9/16	9-11

**Note:** Optional ultra low leak power exhaust extends beyond lifting lug and increases overall "U" dimension by 0.65".

**Figure 36. Optional roof curb dimensions (downflow) — 20 to 75 tons air cooled**

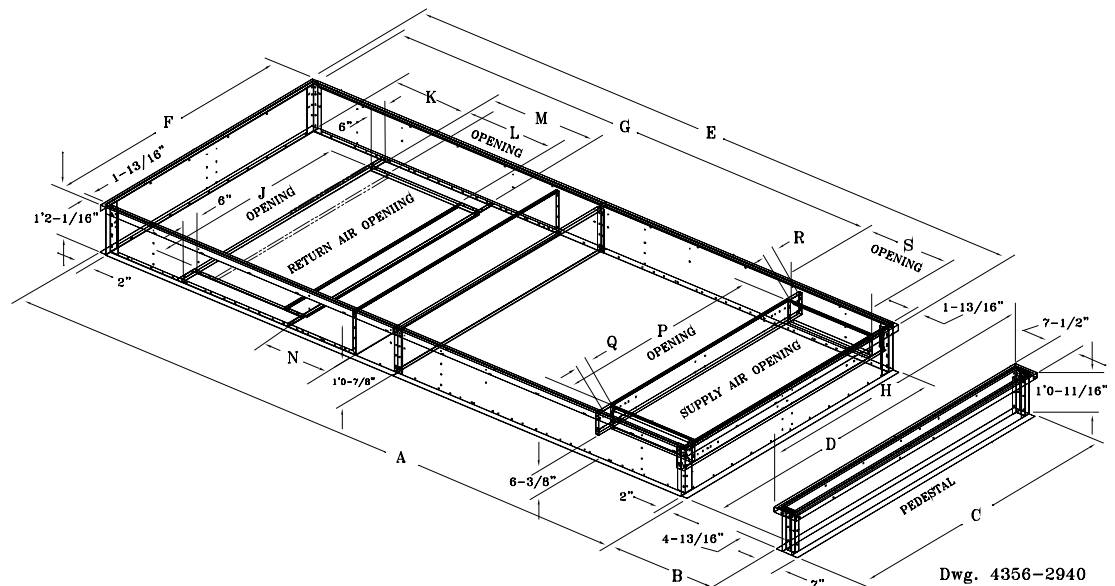
**Note:** The pedestal was purposely designed 1-3/8" shorter than the curb because the unit base rails rest on the pedestal at one point and on the curb at a different point.

**Table 79. Downflow roof curb dimensions (ft. in.) — 20 to 75 tons air cooled**

Tons	Model	A	B	C	D	E	F	G	H	J
20,25,30	SAHP	16'-3 7/8"	2'-10 1/16"	7'-10 7/16"	7'-0 13/16"	16'-3 9/16"	7'-0 1/2"	13'-6 15/16"	7'-11 15/16"	5'-8 13/16"
	S*HP	18'-7 1/2"	2'-10 1/16"	7'-10 7/16"	7'-0 13/16"	18'-7 3/16"	7'-0 1/2"	15'-10 9/16"	7'-11 15/16"	5'-8 13/16"
40,50,55	SAHP	19'-1 15/16"	7'-10 1/16"	7'-10 7/16"	7'-0 13/16"	19'-1 5/8"	7'-0 1/2"	16'-2 9/16"	7'-11 15/16"	5'-8 13/16"
	S*HP	22'-4 1/2"	7'-10 1/16"	7'-10 7/16"	7'-0 13/16"	22'-4 1/8"	7'-0 1/2"	19'-5"	7'-11 15/16"	5'-8 13/16"
60,70,75	SAHP	19'-1 15/16"	7'-10 1/16"	9'-11 15/16"	9'-2 5/16"	19'-1 5/8"	9'-2"	16'-2 9/16"	10'-1 7/16"	7'-10 5/16"
	S*HP	22'-4 1/2"	7'-10 1/16"	9'-11 15/16"	9'-2 5/16"	22'-4 1/8"	9'-2"	19'-5"	10'-1 7/16"	7'-10 5/16"
Tons	K	L	M	N	P	Q	R	S		
20,25,30	2'-0"	2'-5 5/16"	2'-11 5/16"	1'-10 5/8"	5'-9 1/2"	0'-5 11/16"	0'-5 11/16"	2'-3 5/16"		
	2'-0"	2'-5 5/16"	2'-11 5/16"	1'-10 5/8"	5'-7 3/8"	1'-0 7/16"	0'-1"	2'-3 5/16"		
40,50,55	2'-0"	3'-6"	4'-0"	1'-10 5/8"	5'-9 1/2"	0'-5 11/16"	0'-5 11/16"	2'-5 15/16"		
	2'-0"	3'-6"	4'-0"	1'-10 5/8"	5'-7 3/8"	0'-11 3/16"	0'-2 1/4"	2'-5 15/16"		
60,70,75	2'-0"	3'-6"	4'-0"	1'-10 5/8"	6'-11 7/8"	0'-11 3/16"	0'-11 3/16"	2'-5 15/16"		
	2'-0"	3'-6"	4'-0"	1'-10 5/8"	7'-8 3/4"	0'-11 3/16"	0'-2 3/8"	2'-5 15/16"		

**Figure 37. Heating/cooling and cooling only rooftops — 90, 105, 115, 130 ton air-cooled**

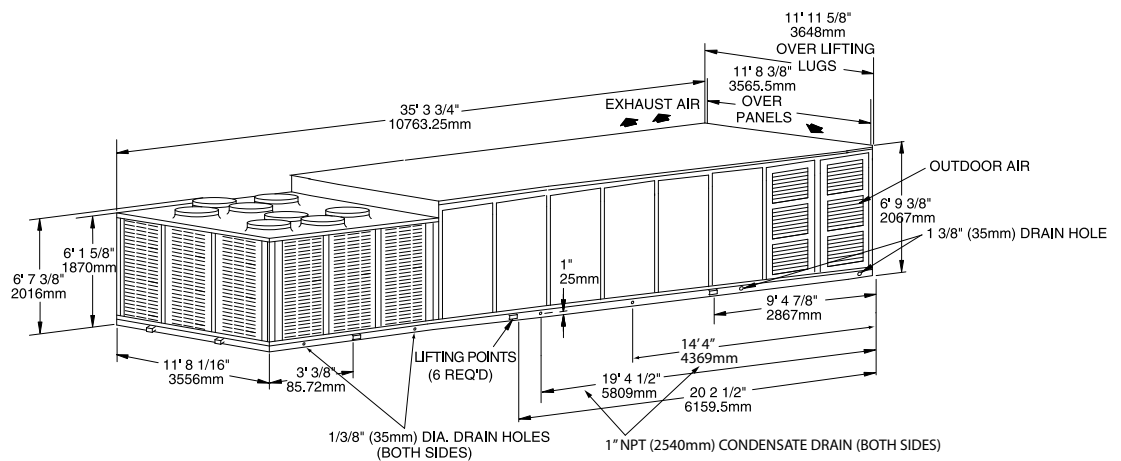

*Note: Ultra low leak power exhaust damper option extends 0.65\"/>*

**Figure 38. Roof curb heating/cooling and cooling only rooftops — 90, 105, 115, 130 ton air-cooled**

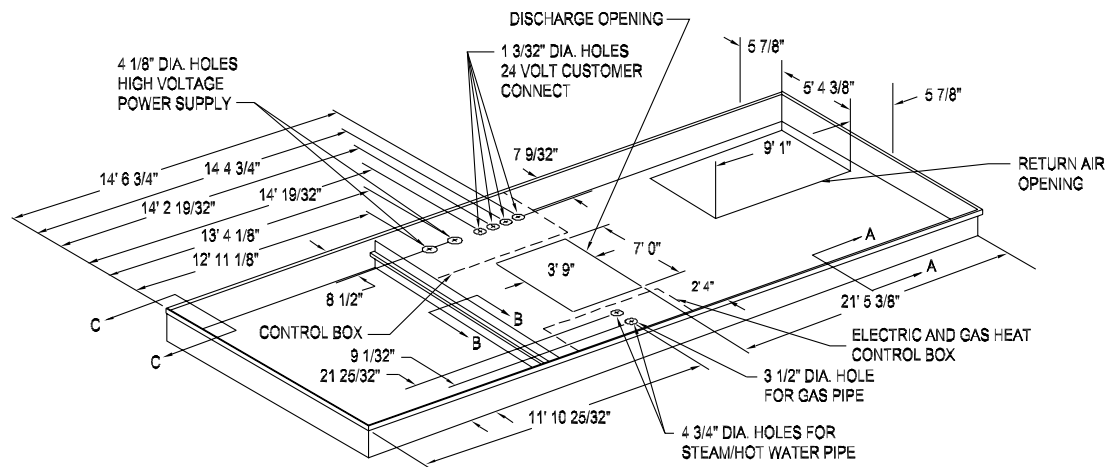

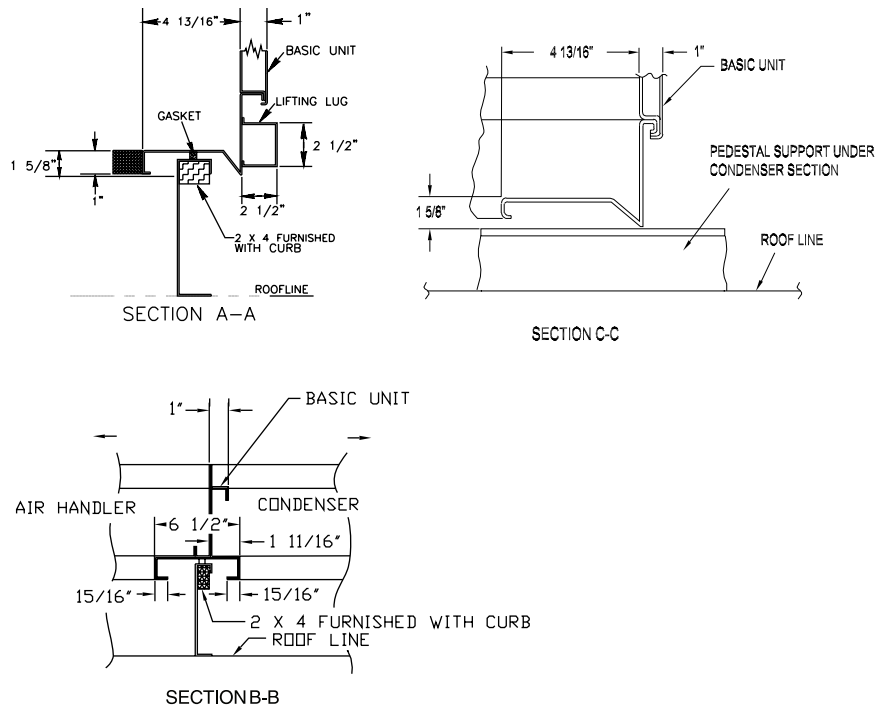
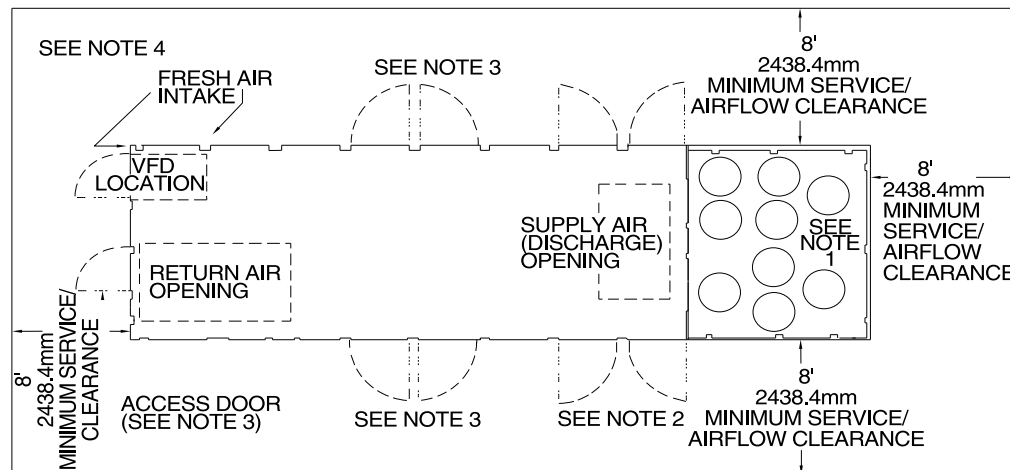

**Figure 39. Cross section through roof curb and base pan**

**Figure 40. Service clearance — 90 to 130 tons air-cooled**

**Notes:**

- Provide unrestricted clearance over the condenser fans.
- A minimum clearance of 2' 4 1/2" is required to open the hinged control panel doors. Both doors swing outward in a 180-degree arc.
- A minimum clearance of 2' 10 3/4" is required to open the access doors on the unit's supply fan, evaporator, filter and relief fan sections. All hinged doors swing outward in a 180-degree arc.
- 90-130 ton models have two outdoor air intakes located at the back of the unit and one small outdoor air intake located at the end of the unit.
- A minimum clearance of 3' 7" is required to open the hinged access panel door to the VFD enclosure.
- Unit drawing is representative only and may not accurately depict all models.



# Weights

**Table 80. Air-cooled condenser - approximate operating weights (lbs.)**

Unit	Without Exhaust Fan						With Exhaust Fan					
	SA	SX	SE	SF	SL	SS	SA	SX	SE	SF	SL	SS
20	4603	4924	4924	4924	4924	4924	4901	5222	5487	5742	5612	5776
25	4607	4927	4927	4927	4927	4927	4911	5231	5496	5751	5621	5885
30	5030	5376	5376	5376	5376	5376	5487	5833	6098	6353	6223	6385
40	7115	7470	7470	7470	7470	7470	7785	8140	8465	8855	8675	8355
50	7708	8158	8158	8158	8158	8158	8427	8877	9202	9592	9412	9143
55	7706	8155	8155	8155	8155	8155	8425	8874	9199	9589	9409	9236
60	8800	9445	9445	9445	9445	9445	9743	10388	10713	11203	11198	11371
70	8973	9618	9618	9618	9618	9618	9916	10561	10886	11376	11371	11544
75	9305	9953	9953	9953	9953	9953	10248	10896	11221	11711	11706	11879
90	X	13112	13112	13112	13112	13112	X	14450	14605	15250	15325	15300
105	X	13745	13745	13745	13745	13745	X	15083	15238	15883	15958	15933
115	X	13949	13949	13949	13949	13949	X	15287	15442	16087	16162	16137
130	X	14235	14235	14235	14235	14235	X	15573	15728	16373	16448	16423

**Notes:**

- Weights shown are for air-cooled units with standard efficiency and include the following features: FC fans, Supply Fan VFD, standard scroll compressors, 100% economizer, throwaway filters, maximum motor sizes, 460V XL start, high capacity heat, and access doors.
- Weights shown represent approximate operating weights and have a  $\pm 10\%$  accuracy. To calculate weight for a specific unit configuration, utilize Trane Select Assist™ or contact the local Trane sales representative. ACTUAL WEIGHTS ARE STAMPED ON THE UNIT NAMEPLATE.

**Table 81. Roof curb max weight (lbs)**

Unit	Roof Curb Max. Weight	
	SAH_	SEH_, SFH_, SLH_, SSH, SXH_
20, 25, 30	490	510
40, 50, 55	515	550
60, 70, 75	610	640
90-130	N/A	770

**Note:** Roof curb weights include the curb and pedestal.



# Mechanical Specifications

## General

Units shall be specifically designed for outdoor rooftop installation on a roof curb and be completely factory assembled and tested, piped, internally wired, fully charged with R-454B compressor oil, factory run tested and shipped in one piece. Units shall be available for direct expansion cooling only, or direct expansion cooling with natural gas, electric, hot water or steam heating. Filters, outside air system, exhaust air system, optional non-fused disconnect switches and all operating and safety controls shall be furnished factory installed.

All units shall be UL listed to US and Canadian Safety Standards. Cooling capacity shall be rated in accordance with AHRI Standard 360. All units shall have decals and tags to aid in service and indicate caution areas. Electrical diagrams shall be printed on long life water resistant material and shall ship attached to control panel doors.

## Casing

Exterior panels shall be zinc-coated, galvanized steel painted with a slate gray air-dry finish durable enough to withstand a minimum of 672 hours consecutive salt spray application in accordance with standard ASTM B117. Screws shall be zinc-plus-zinc chromate coated.

Heavy gauge steel hinged access panels with tiebacks to secure door in open position shall provide access to filters and heating sections. Refrigeration components, supply air fan and compressor shall be accessible through removable panels as standard. Unit control panel, filter section, and gas heating section shall be accessible through hinged access panels as standard. Optional double wall construction hinged access doors shall provide access to filters, return/exhaust air, heating and supply fan section. All access doors and panels shall have neoprene gaskets. Interior surfaces or exterior casing members shall have ½ inch fiberglass insulation.

Unit base shall be watertight with heavy gauge formed load-bearing members, formed recess and curb overhang. Unit lifting lugs shall accept chains or cables for rigging. Lifting lugs shall also serve as unit tie down points.

## Refrigeration System

### Compressors

The Trane Scroll compressor shall be industrial grade, direct drive 3600 RPM maximum speed scroll type. The motor shall be suction gas-cooled hermetic design. Compressor shall have centrifugal oil pump with dirt separator, oil sight glass, and oil charging valve. Compressor shall also be provided with thermostatic motor winding temperature control to protect against excessive motor temperatures resulting from over-/under-voltage or loss of charge, high and low pressure cutouts, and reset relay.

### eFlex™ Variable Speed Compressors (200/230/460/575V)

Trane® eFlex™ variable speed compressors shall be capable of speed modulation from 25 Hz to a maximum of 100 Hz. The minimum unit capacity shall be 15% of full load or less. The compressor motor shall be a permanent magnet type. Each compressor shall have a crankcase heater installed, properly sized to minimize the amount of liquid refrigerant present in the oil sump during off cycles. Compressors shall be equipped with a bearing oil injection system that optimizes bearing and scroll set lubrication, sealing, and controls the oil circulation rate. Optimal bearing lubrication shall be provided by a gear oil pump.

Each variable speed compressor shall be matched with a specially designed variable frequency drive which modulates the speed of the compressor motor and provides several compressor protection functions. Control of the variable speed compressor and inverter shall be integrated with the IPak unit controller to ensure optimal equipment reliability and efficiency.

## Power Supplies

The 20 to 75 tons air-cooled rooftops shall be available with 200, 230, 460, and 575 voltage power supplies and 90 to 130 tons units shall be available with 460 or 575 voltage power supplies.



## Mechanical Specifications

---

### Ambient Control

Variable speed condenser motors shall be provided to allow the unit to operate down to 0°F.

### Corrosion Protected Condenser Coil

Optional protection on the all aluminum, microchannel condenser coil shall consist of a corrosion resistant coating that shall withstand ASTM B117 Salt Spray test for 6,000 hours and ASTM G85 A2 Cyclic Acidified Salt Fog test for 2,400 hours. This coating shall be added after coil construction covering all tubes, headers and fin edges, therefore providing optimum protection in more corrosive environments.

### Modulating Hot Gas Reheat Control

A reheat condenser coil shall be factory installed downstream of the unit evaporator coil. Modulating electronic valves shall control the flow of refrigerant between the indoor reheat and outdoor condensers in response to the unit discharge air temperature in order to dehumidify the space. The modulating valves shall always apply to circuit 1.

Modulating reheat valves shall be electronically controlled by the Symbio™ 800 unit controller. This fully integrates reheat valve control with unit operation to ensure optimal equipment reliability and efficiency. Modulating reheat valves shall be stepper type valves for precise refrigerant control. Valve position shall be displayed at the user interface to assist field diagnostics.

### Hot Gas Bypass

Electronic Hot Gas Bypass valve piping and controls shall all be included on circuit 1 to allow operation at low airflow, avoiding coil frosting and damage to compressor. When suction pressure falls below valve adjustable setpoint, the valve shall modulate hot gas to the inlet of the evaporator. Valves sized to meet ASHRAE 90.1.

### Evaporator Coil Drain Pan

Drain pan shall be double sloping [galvanized] [stainless] steel and promote runoff of standing water from condensation inside the unit. Two drain pipes shall be installed through the base channel on each side of the unit. Drain pipe connection shall be installed through the side of the unit and connector size is 1.25 NPTI. The stainless steel option shall provide protection in corrosive environments.

### Leak Detection Sensors

Unit shall be furnished with a leak detection system from the factory when a circuit refrigerant charge exceeds 4 lbs. The leak detection system shall consist of one or more refrigerant detection sensors. When the system detects a leak, the unit controller shall initiate mitigation actions.

## Air-Cooled Condensing

### Air-Cooled Condenser Coil

Condenser coils shall have all aluminum microchannel coils. All coils shall be leak tested at the factory to ensure pressure integrity. The condenser coil shall be pressure tested to 650 psig. Subcooling circuit (s) shall be provided as standard.

The High Efficiency Condenser Coil option shall include additional rows of coil that provide increased efficiency compared to standard coils.

### Air-Cooled Condenser Fans and Motors

All condenser fans shall be vertical discharge, direct drive fans, statically balanced, with aluminum blades and zinc plated steel hubs. Condenser fan motors shall be three-phase motors with permanently lubricated ball bearings, built-in current and thermal overload protection and weather-tight slingers over motor bearings. Modulating condenser fans shall be provided on eFlex™ units.

## **Air Handling System**

### **Supply Fan**

Supply fan motors shall be open drip-proof. All supply fans shall be dynamically balanced in factory. Supply fan shall be test run in unit and shall reach rated rpm. All 60 Hz supply fan motors shall meet the Energy Independence Security Act of 2007 (EISA).

#### **20 to 75 Tons with Forward-Curved Supply Fan**

Supply fans shall have two double-inlet, forward-curved fans mounted on a common shaft with fixed sheave drive. Fans shall be factory-tested to reach rated rpm before the fan shaft passes through first critical speed. Fan shaft shall be mounted on two grease lubricated ball bearings designed for 200,000 hours average life. Optional extended grease lines shall allow greasing of bearings from unit filter section. Fan motor and fan assembly shall be mounted on common base to allow consistent belt tension with no relative motion between fan and motor shafts. Entire assembly shall be completely isolated from unit and fan board by double deflection rubber-in-shear isolators, or by optional 2" deflection spring isolation.

#### **20 to 75 Tons eDrive™ Direct-Drive Plenum Supply Fan**

The eDrive™ direct drive plenum supply fan shall be [one][two] single width, single inlet 9-blade plenum fans. Fan blades shall be aluminum backward-inclined airfoil. Plenum fans shall be direct-driven. Entire assembly shall be completely isolated from unit and fan board by 2" deflection spring isolation. Multiple fan widths shall be available to optimize efficiency. Fan shall not require routine maintenance such as fan bearing lubrication, belt tensioning and replacement, sheave alignment, and setscrew torque checks.

#### **90 to 130 Tons Forward-Curved Supply Fan**

All supply fans shall have two independent fan assemblies with double inlet, forward-curved air foil fan, motor and fixed pitch sheave drive. All fans shall be statically and dynamically balanced and tested in factory. Supply fans shall be test run in unit as part of unit test. Unit shall reach rated rpm before fan shaft passes through first critical speed. Fan shafts shall be mounted on two grease lubricated ball bearings designed for 200,000 hours average life.

Optional extended grease lines shall allow greasing of bearings from unit filter section. Fan motor and fan assembly shall be mounted on common base to allow consistent belt tension with no relative motion between fan and motor shafts. Entire assemblies shall be completely isolated from unit and fan board by two-inch deflection spring isolators.

## **Electrical**

Unit shall be completely factory wired with necessary control and contactor pressure lugs or terminal block for power wiring. Units shall provide an option for a non-fused disconnect with external handle for safety.

### **Unit Voltage**

Rooftops shall be available with 200, 230, 460, and 575 voltage, 3 phase, 60 Hz power supplies.

### **Unit Interrupt Rating (Short Circuit Current Rating-SCCR)**

A standard SCCR of 5,000 amps shall be applied to the unit enclosure. A high fault SCCR option is available that provides a 65,000A SCCR for 200V, 230V, and 460V units; 25,000A SCCR for 575V units.

### **Internal Shaft Grounding Ring**

Motors shall have internal bearing protection for use with VFDs to provide a conductive discharge path away from the motor bearings to ground. Bearing Protection Rings shall be circumferential rings with conductive micro fibers which provide the path of least resistance and dramatically extend motor life.



## Mechanical Specifications

---

### Phase Monitor

Standard on 20 to 75 tons. Phase monitor shall protect 3-phase equipment from phase loss, phase reversal and phase imbalance. Any fault condition shall produce a Failure Indicator LED and send the unit into an auto stop condition. cULus approved.

### Non-Fused Disconnect

An external handle mounted on the control box door shall be provided to disconnect unit power with the control box door closed for safety.

### Symbio™ 800 Controller

The Symbio 800 controller is an application-specific, programmable controller that is factory installed and designed to control packaged HVAC equipment. A 7" user interface features a touch-sensitive color screen that provides facility managers with at-a-glance operating status, performance monitoring, scheduling changes and operating adjustments. Other advanced features include automated controller backup and optional features such as secure remote connectivity, wireless building communications, mobile device connectivity and custom programming with expandable I/O.

### BACnet® Communication Interface

Rooftop controller communication interface shall use the BACnet protocol with an Ethernet (IEEE 802.3) or RS485 (EIA-485) physical interface and an appropriate data link technology as defined in ANSI®/ASHRAE® Standard 135-2012 (for example, BACnet/IP, BACnet/MSTP). The rooftop controller shall be BTL listed as a BACnet Advanced Application Controller (B-AAC) as defined in ANSI/ASHRAE Standard 135-2012.

### AirFi® Wireless Communication Interface Module (WCI)

Rooftop controller communication interface shall use the BACnet protocol with a ZigBee (IEEE 802.15.4) physical interface and an appropriate data link technology as defined in ANSI®/ASHRAE® Standard 135-2012. Wireless communication shall utilize open standard protocols, of which BACnet and ZigBee shall be considered appropriate.

Each rooftop controller wireless communication interface shall self-heal to maintain operation in the event of network communication failure.

Each zone sensor wireless communication interface shall be capable of many-to-one sensors per controller to support averaging, monitoring, and multiple zone applications. Sensing options shall include temperature, relative humidity, CO<sub>2</sub>, and occupancy.

### LonTalk® Communication Interface Module

The rooftop controller shall support LonTalk allowing for control and monitoring of the unit through a RS485, two wire communication link.

### Modbus Communication Protocol

All documented status and control points shall be available as Modbus RTU or Modbus TCP registers as defined in the Modbus protocol specification through an RS485, two wire communication link.

### Power Monitor

Factory installed power meter shall measure unit energy usage to 0.2% accuracy (ANSI C12.20) and communicate through the Symbio™ 800 controller enabling viewing through user interface or building automation system.

### Controls Expansion Hardware

The rooftop controller shall have field applied controls capability. Factory installed expansion hardware (XM70) shall have 19 inputs/outputs. Additional expansions may be added in the field.

## Rapid Restart

Option provides immediate start-up upon power failure. A backup generator shall be required on site before unit start-up. Rapid Restart shall begin immediately after recovery from a power loss and work by restarting the compressors and supply fan quickly to provide full cooling within 2 to 3 minutes.

## Operator Display

The roof top unit (RTU) shall include a 7-inch, touch-sensitive color screen that provides operating status, performance monitoring, and scheduling changes and operating adjustments.

## Secure Remote Access

Manufacturer shall provide secure remote access to the HVAC equipment with, or without, the presence of a Building Automation System. Secure remote access shall not require IP ports to be "exposed" (port-forwarded or external public IP addresses) to the Internet. Manufacturer shall update secure remote access software as necessary to follow cyber security best practices and respond to cyber security events.

## Filters

### General

Filter options shall mount integral within unit and be accessible by hinged access panels.

### No Filters Option (Two-inch throwaway filter rack only)

Shall provide a complete set of two-inch thick filter racks, without the filter media to accommodate applications which require field supplied filters.

### No Filters Option (Bag/cartridge with pre-filter filter rack)

Shall provide a long-lasting galvanized steel frame without the filter media to accommodate applications which require field supplied filters.

### Pre-Evaporator Filter Options (Available for all units)

#### Throwaway Filters, MERV 4

Filters shall be two-inch [50.8 mm] thick, UL Class 2, glass fiber type and rated at 80% average synthetic dust weight arrestment when tested in accordance with ASHRAE 52-76 and 52.1 test methods. Filters shall be mounted in galvanized steel rack.

#### Permanent Cleanable Wire Mesh Option, MERV 3

Shall be washable permanent wire mesh with metal frame.

#### High Efficiency Throwaway Option, MERV 8

Shall be two-inch high efficiency media filters with average dust spot efficiency of 25-35 percent and an average arrestance in excess of 90 percent when tested in accordance with ASHRAE 52-76.

#### 90-95 Percent Bag Filter Option, MERV 14

Shall have glass fiber media mounted in a galvanized steel frame. These Class 1 single piece disposable bag filters shall have a 90-95% dust spot efficiency rating per ASHRAE 52-76. To ensure maximum bag filter life two-inch MERV 8 pre-filters shall be included with the bag filters.

#### 90-95 Percent Cartridge Filter Option, MERV 14

Twelve-inch deep cartridge filters shall be mounted in a galvanized steel frame. Filters shall be Class 1 listed by Underwriters Laboratories and have a 90-95% dust spot efficiency per ASHRAE 52-76. To ensure maximum cartridge filter life, two-inch MERV 8 pre-filters shall be provided.

### Final Filter Options (Available for SX Units only)

Final filter section filter options shall mount integral within the blank section unit casing and be accessible by hinged access doors.



## Mechanical Specifications

---

### **90-95 Percent, Cartridge, Final Filter Option, Merv 14**

Available on cooling only SX units. Twelve-inch deep cartridge filters shall be mounted in a galvanized steel frame. Filters shall be Class 1 listed by Underwriters Laboratories and have a 90-95% dust spot efficiency per ASHRAE 52-76.

### **90-95 Percent, Cartridge Filter with two-inch pre-filters, Final Filter Option, MERV 14**

Available on cooling only SX units. 2", MERV 8 pre-filters shall be included with the cartridge filters. Pre-filters shall be mounted in the same galvanized steel frame as the cartridge final filters.

## Relief Air

### General

Return air options shall include no relief, barometric relief, 100 percent modulating relief fan and 100 percent modulating relief fan with direct space building pressurization control. Relief motors shall be open drip-proof fan cooled. All 60 Hz motors meet the Energy Independence and Security Act of 2007 (EISA). All 50 Hz relief motors meet the U.S. Energy Policy Act of 1992 (EPACT).

### No Relief (standard)

Rooftops can be built for makeup air applications with no relief. Relief air opening shall be sealed with panel and made watertight.

### Barometric Relief Option

Gravity dampers shall open to relieve positive pressure in the return air section of the rooftop. Barometric relief dampers shall relieve building overpressurization, when that overpressurization is great enough to overcome the return duct pressure drops.

### Modulating Relief Fan Option

Two, double-inlet, forward-curved fans shall be mounted on a common shaft with fixed sheave drive. All fans shall be dynamically balanced and tested in factory before being installed in unit. Relief fan shall be test run as part of unit final run test. Unit shall reach rated rpm before fan shaft passes through first critical speed. Fan shaft shall be mounted on two grease lubricated ball bearings designed for 200,000-hour average life.

Optional extended grease lines shall be provided to allow greasing of bearings from unit filter section. Fan motor and assembly shall be mounted on common base to allow consistent belt tension with no relative motion between fan and motor shafts. Entire assembly shall be completely isolated from unit and fan board by spring isolation on motor sizes larger than 5 hp.

#### **With Statitrac™ Enabled**

For VAV rooftops, the modulating relief discharge dampers (or VFD) shall be modulated in response to building pressure. A differential pressure control system, (Statitrac™), shall use a differential pressure transducer to compare indoor building pressure to outdoor ambient atmospheric pressure. The FC relief fan shall be turned on when required to lower building static pressure setpoint.

#### **With Statitrac™ Disabled**

Relief dampers at unit outlet shall modulate relief airflow in response to OA damper position.

### Ventilation Override Mode

With the ventilation override option installed, the unit shall be programmed to transition to up to 5 different programmed sequences for Smoke Purge, Evacuation, Pressurization, Purge, Purge with duct control sequence and Unit off. The transition shall occur when a binary input on the VOM is closed (shorted); this would typically be a hard wired relay output from a smoke detector or fire control panel.



## Return Air

### General

Return air options shall include 100 percent modulating return fan and 100 percent modulating return with direct space building pressurization control. All 60 Hz motors meet the Energy Independence and Security Act of 2007 (EISA).

### 100 Percent Modulating Return Fan

A single width plenum fan with airfoil blade shall be mounted on a shaft with fixed sheave drive. The fan shall be dynamically balanced for the operating envelop and tested in factory before being installed in unit. The plenum fan shall be test run in unit as part of unit test. Fan operating envelop rpm shall be below first critical speed.

Fan shaft shall be mounted on two grease lubricated ball or roller bearings designed for 200,000-hour average life. Extended grease lines shall be provided to allow greasing of bearings from section base rail. Fan motor and assembly shall be mounted on common base to allow consistent belt tension with no relative motion between fan and motor shafts. The entire assembly shall be completely isolated from unit with 2-inch spring isolators. Discharge dampers at unit outlet shall modulate relief airflow in response to OA / return air damper position.

A single width plenum fan with airfoil blade can relieve up to 100 percent supply air. The fan operates in conjunction with the supply fan. The relief damper modulates in response to economizer damper position on constant volume rooftops.

### 100 Percent Modulating Return Fan with Statitrac™ Control Option

A single width plenum fan with airfoil blade shall be mounted on a shaft with fixed sheave drive. The fan shall be dynamically balanced for the operating envelop and tested in factory before being installed in unit. The plenum fan shall be test run as part of unit final run test. Fan operating envelop rpm shall be below first critical speed.

Fan shaft shall be mounted on two grease lubricated ball or roller bearings designed for 200,000-hour average life. Extended grease lines shall be provided to allow greasing of bearings from section base rail. Fan motor and assembly shall be mounted on common base to allow consistent belt tension with no relative motion between fan and motor shafts. The entire assembly shall be completely isolated from unit with 2-inch spring isolators.

Option shall be provided with all the necessary controls to control/ maintain building space pressure through a VAV rooftop. The variable frequency drive (VFD) modulates the speed of the return fan motor in response to return plenum pressure. The 100 percent modulating relief damper shall be modulated in response to building pressure. A differential pressure control system, (Statitrac), shall use a differential pressure transducer to compare indoor building pressure to outdoor ambient atmospheric pressure. The (Statitrac) control system shall modulate the dampers to control the building pressure to within the adjustable, specified deadband that shall be adjustable at the user interface. The return fan shall modulate in response to return plenum static pressure. Optional bypass control provides full nominal airflow in the event of drive failure.

## Outside Air

### General

Three outside air options: 100 percent return air, 0 to 25 percent manually controlled outside air, and 0-100 percent fully modulating economizer.

### Manual Outside Air Option

Manually controlled outside air damper shall provide up to 25 percent outside air. Manual outside air damper shall be set at desired position at unit startup.

### 0-100 Percent Modulating Economizer Option

Economizer option shall be operated through the primary temperature controls to automatically utilize outside air for "free" cooling. Automatically modulated return and outside air dampers shall maintain



## Mechanical Specifications

---

proper temperature in the conditioned space. Economizer shall be equipped with an automatic lockout when the outdoor high ambient temperature is too high for proper cooling.

Minimum position control shall be standard and adjustable at the user interface or through the building management system. A spring return motor shall ensure closure of OA dampers during unit shutdown or power interruption. Mechanical cooling shall be available to aid the economizer mode at any ambient. Standard economizer dampers leakage rate shall be 2.5 percent of nominal airflow (400 cfm/ton) at 1 inch wg. static pressure.

### Low-Leak Economizer Damper Option

Low leak dampers shall be provided with gasketing added to the damper blades and rolled stainless steel jamb seals to the sides of the damper assembly. Low leak economizer dampers shall have a leakage rate of 1 percent based on testing data completed in accordance with AMCA Standard 500 at AMCA Laboratories.

### Ultra Low-Leak Economizer Damper Option

Economizer return and outside air dampers shall be provided with horizontal airfoil blades and spring-return actuators. The economizer shall have a functional life of 60,000 opening and closing cycles. Dampers shall be AMCA 511 Class 1A certified with a maximum leakage rate of 3 CFM/sq-ft at 1.0 in WC pressure differential thus exceeding requirements of ASHRAE 90.1-2013, California Title 24-2013, and IECC-2012.

IntelliPak® units ordered with ultra low leak economizers shall be listed on the California Energy Commission Registry for factory compliance with Title 24 Economizer and FDD requirements. A label shall be applied to the unit identifying construction with the ultra low leak economizer and FDD controls.

Ultra low leak motorized exhaust dampers shall be provided when the ultra low leak economizer is ordered with an exhaust/return option that includes motorized dampers. Ultra low leak motorized exhaust dampers shall be AMCA 511 Class 1A certified with a maximum leakage rate of 3 cfm/sq-ft at 1.0 in WC pressure differential. This exceeds the most stringent requirements of ASHRAE 90.1 and IECC (4 CFM/sq-ft at 1.0 in WC pressure differential).

### Economizer Control with Comparative Enthalpy

Two enthalpy sensors shall be provided to compare total heat content of the indoor air and outdoor air to determine the most efficient air source when economizing.

### Economizer Control with Reference Enthalpy

An outdoor enthalpy sensor shall be provided to compare the total heat content of outdoor air to a locally adjustable setpoint. The setpoint shall be programmed at the user interface to determine if the outdoor enthalpy condition is suitable for economizer operation.

### Economizer Control with Dry Bulb

An outdoor temperature sensor shall be included for comparing the outdoor dry bulb temperature to a locally adjustable temperature setpoint. The setpoint shall be programmed at the user interface to determine if outdoor air temperature is suitable for economizer operation.

### Differential Dry Bulb

An outdoor and return air temperature sensor is used to compare the dry bulb temperature of the outside air to the return air temperature to determine if it is suitable to economize.

### Outside Air Measurement (Traq™)

A factory mounted airflow measurement station (Traq™) shall be provided in the outside air opening to measure airflow. The airflow measurement station shall measure from 40 CFM/ton to maximum airflow. The airflow measurement station shall adjust for temperature variations. Measurement accuracy shall meet requirements of LEED IE Q Credit 1 as defined by ASHRAE 62.1-2007.

## Demand Control Ventilation

When equipped with a CO<sub>2</sub> sensor, the fresh air damper position shall modulate in response to a CO<sub>2</sub> sensor in the conditioned space, in order to minimize the unit energy consumption and simultaneously meet the ventilation requirements of ASHRAE Std 62.1. The Traq™ airflow monitoring solution shall augment the system, allowing for measurement and control of outside airflow.

## Heating System

### Electric Heating Option

All electric heat models shall be completely assembled and have wired electric heating system integral within the rooftop unit. Heavy duty nickel chromium elements internally wired with a maximum density of 40 watts per square inch shall be provided. Heater circuits shall be 48 amps or less, each individually fused. Automatic reset high limit control shall operate through heater primary contactors and a manual reset high limit control, located in the electric heat control box, shall operate through heater backup contactors.

The 460 and 575 volt electric units shall have optional factory mounted non-fused disconnect switch located in the main control panel to serve the entire unit.

The 200 and 230 volt SEH\* models shall have separate power supply to heating section.

### Steam Heating Option

Steam coils shall be Type NS, with non-freeze steam distribution circuits. Distributor tubes shall be located concentrically within condensing tubes to assure even steam distribution. Coils shall be pitched to provide complete drainage. Steam modulating valve with actuator shall be provided.

### Hot Water Heating Option

Hot water coils shall be Type 5W and factory mounted in the rooftop unit to provide complete drainage of coil. Hot water modulating valve with actuator shall be provided.

### Gas-Fired Heating Option

All gas-fired units shall be completely assembled, have a wired, gas-fired heating system integral within unit, and fire tested prior to shipment. Units shall be cULus approved specifically for outdoor applications downstream from refrigerant cooling coils.

All gas heaters shall have 81% steady state efficiency, meeting the 2023 Department of Energy efficiency code. Gas-fired heating system control shall be fully integrated with the unit controls. Gas safety controls shall include electronic flame sensing capability, which proves combustion air prior to ignition sequence and during operation. The ignition sequence shall include a pre-purge cycle. Direct spark ignition shall be provided on all heat exchangers; ultra modulating heaters shall have direct spark ignition provided to the pilot line.

A three minute delay shall be provided between first and second stage gas valve operation on two-stage heaters.

Heat exchangers shall be drum and tube design with pre-mix burners. Free-floating design shall eliminate expansion and contraction stresses and noises. Heating system shall incorporate forced draft fans and include a chimney that exhausts away from the air intake. All gas heaters shall be made from grades of stainless steel suitable for condensing situations. Gasketed cleanout plate shall be provided for maintenance and inspection of tubes/turbulators.

All gas piping shall be threaded connection with a pipe cap provided. Gas supply connection shall be provided through the side or bottom of unit. Heat exchanger shall be factory pressure and leak tested.

## Miscellaneous Options

### Two-Inch Spring Isolators

Supply and relief/return fan (if applicable) assemblies shall be isolated with two-inch nominal deflection to reduce transmission of vibrations (standard feature on 90 to 130 tons).



## Mechanical Specifications

---

### Special Unit Paint Colors

Shall allow matching of HVAC equipment to customer specified color. This option shall be for standard paint compound in different colors only.

## Service

### Access Doors

Hinged access doors shall provide easy access to supply fan, filters, exhaust/return fan, and the heating section. Double wall construction with dual density insulation sandwiched between heavy gauge galvanized steel panels for strength and durability can be selected.

### Supply Airflow Measurement (Piezometer)

Plenum supply fan shall have an airflow measurement device to measure differential pressure and to calculate fan airflow. The device shall be capable of measuring airflow within  $\pm 5$  percent total accuracy when operating within the stable operating region of the fan curve. Fan airflow performance and noise levels shall not be affected by the installation of the device. The fan inlet shall not be obstructed by the airflow measurement device.

*Note: Piezometer option does not come with transducers or controls for flow monitoring.*

### Powered Convenience Outlet

A 15A, 115V Ground Fault Interrupter convenience outlet shall be factory installed. It shall be wired and powered from a factory mounted transformer. Unit-mounted, non-fused disconnect with external handle shall be furnished with factory powered outlet.

### Extended Grease Lines

Lines shall allow greasing of supply and relief fan bearings through the filter access door.

### IntelliPak™ Replacement Unit (IRU)

The IntelliPak replacement solution shall include a condenser base pan, strengthening of the condenser section with welded reinforcement of condenser base rail, as well as welded integral supports to the condenser base. This additional strength shall allow the reuse of the existing pedestal as well as any Trane® full perimeter curb and reduce installation risk and labor. Also optional with stainless steel.

## Accessories

### Roof Mounting Curb

Roof mounting curb shall be heavy gauge zinc coated steel with nominal two-inch by four-inch nailer setup. Supply/return air opening gasketing shall be provided. Curb shall ship knocked down for easy assembly. Channel shall be provided to allow for adjustment of return air opening location. Curb shall be manufactured to National Roofing Contractors Association guidelines.

### Electronic Zone Sensors

- Remote Sensor shall be available to be used for remote zone temperature sensing capabilities when zone sensors are used as Remote panels
- Integrated Comfort System sensors shall be available with sensor only, sensor with timed override, and sensor with local temperature setpoint adjustment with timed override.
- Humidity Sensor - Monitors the humidity levels in the space for 1) Humidification and/or 2) Modulating Hot Gas Reheat.

### Field-Installed Kits

- Trane® LonTalk® Communication Interface kit - For future opportunities and upgrade flexibility, this kit contains a LonTalk Communication Interface module, which is required for communication with Tracer® Summit or a 3rd party building automation system.

- Trane Air-Fi® Wireless Communications Interface (Field Installed) — Trane Air-Fi Wireless Communications Interface (WCI) provides wireless communication between the Tracer SC, Unit Controllers.

## **Certified AHRI Performance**

Packaged Rooftop units cooling, heating capacities and efficiencies shall be rated within the scope of the Air-Conditioning, Heating and Refrigeration Institute (AHRI) Certification Program and display the AHRI Certified® mark as a visual confirmation of conformance to the certification sections of AHRI Standard 340-360 (I-P) and ANSIZ21.47 and 10 CFR Part 431 pertaining to Commercial Warm Air Furnaces. The applications in this catalog specifically excluded from the AHRI certification program are:

- Ventilation modes
- Heat Recovery
- Units larger than nominal 63 tons



Notes

---



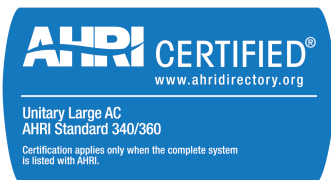

The AHRI Certified mark indicates Trane U.S. Inc. participation in the AHRI Certification program. For verification of individual certified products, go to [ahridirectory.org](http://ahridirectory.org).

Trane - by Trane Technologies (NYSE: TT), a global innovator - creates comfortable, energy efficient indoor environments for commercial and residential applications. For more information, please visit [trane.com](http://trane.com) or [tranetechnologies.com](http://tranetechnologies.com).

Trane has a policy of continuous product and product data improvements and reserves the right to change design and specifications without notice. We are committed to using environmentally conscious print practices.