



Product Catalog

# **CenTraVac™ Water-cooled Chillers with Symbio™ Controls**

120 to 4000+ Tons (450 to 14000+ kW)  
60 and 50 Hz





# Introduction

## World's Most Efficient Lowest Emissions Chiller

**Trane EcoWise™ Portfolio**—Trane has always taken a leadership position in environmental stewardship without compromising efficiency, reliability or safety. CenTraVac™ chillers are among the Trane® products within the EcoWise™ portfolio and can operate with next-generation refrigerants R-514A or R-1233zd, both featuring ultra-low GWPs of less than two.

**Standard of Excellence**—Trane found that the straightest path to achieve the highest efficiency with the best reliability is through simplicity of design. The CenTraVac™ chiller has only one primary moving part—a single rotating shaft supported by two bearings. This direct drive concept minimizes the chance of failure by reducing the number of critical parts—no gear boxes, couplings, extra shafts, or shaft seals.

**Economically and Environmentally Sound**—The CenTraVac™ chiller has a proven track record as the world's most efficient, lowest emissions chiller. It is selectable at an unmatched efficiency level of 0.45 kW/ton at standard AHRI conditions. The full load efficiency levels of CenTraVac™ chillers are simply the best available, averaging at least 13.5 percent better than the next best centrifugal chiller available today.

**Lowest Refrigerant Emissions**—The key to the highest energy efficiency and lowest leak rate is use of the low pressure refrigerants. CenTraVac™ chillers are designed to be leak-tight, delivering the industry's lowest documented refrigerant leak rate—less than 0.5 percent annually versus the industry-accepted rate of 2.0 percent. We are so confident in our ability to keep the refrigerant inside our CenTraVac™ chillers, we back each one with a Leak-Tight Warranty—the first offered by any HVAC manufacturer.

**Maximizing System Efficiency**—CenTraVac chillers are designed to support all ASHRAE requirements, guidance and recommendations. The flexible heat exchanger design for superior flow range and turndown, robust compressor for stable operation at full and part load conditions, and onboard controls with chilled water reset and variable flow capabilities allow it to fit perfectly into high performance chilled water systems. A high performance system design approach reduces first cost, lowers operating costs, and is substantially quieter than traditional applied systems. Central to the design are low flow, low temperature, and high efficiency for both airside and waterside systems, along with optimized control algorithms for sustainable performance. Tracer® Symbio™ 800 controls provide the system intelligence required to manage the performance and document the benefits. Smaller equipment and ductwork means supplying less airflow at colder temperatures and enables quieter operation. This also reduces relative humidity in the building, improving indoor air quality. Compared to conventional designs, a high performance chilled water system reduces the total cost of ownership by lowering installation and operating costs.

## Copyright

This document and the information in it are the property of Trane, and may not be used or reproduced in whole or in part without written permission. Trane reserves the right to revise this publication at any time, and to make changes to its content without obligation to notify any person of such revision or change.

## Trademarks

All trademarks referenced in this document are the trademarks of their respective owners.

## Revision History

- Updated Across-the-Line (Full Voltage) in Unit Options chapter.
- Updated Tubes in Mechanical Specifications chapter.



# Table of Contents

General Information.....	6
Local Support .....	6
Custom Built Unit .....	6
ISO 9001 Certified .....	6
Certified AHRI Performance .....	6
District Cooling .....	6
Turbine Inlet Cooling .....	6
CenTraVac Chiller Portfolio.....	7
Trane Gigaton Challenge .....	7
Next-Generation Refrigerants .....	8
Benefits of Low Pressure .....	8
Standard Features .....	9
0.0% Leak-Tight Warranty.....	10
Integrated Rapid Restart.....	10
Optional Features.....	11
Unit Options .....	14
Factory Performance Testing .....	14
Trane Starters and Drives .....	14
Enhanced Electrical Protection Package Option.....	21
Free Cooling Option.....	22
System Options.....	26
Full Heat Recovery.....	26
Partial Heat Recovery .....	27
Thermal/Ice Storage .....	30
Application and Job Site Considerations .....	32
Condenser Water Control .....	32
Water Treatment.....	32
Water Pumps.....	32
Water Flow.....	32
Shipment and Assembly .....	33



## Table of Contents

---

Controls .....	34
Tracer Symbio 800 Controller.....	34
Optional Enhanced Flow Management Package .....	36
Optional Extended Operation Package.....	38
Communication Interface .....	39
Building Automation and Chiller Plant Control.....	39
Standard Protections .....	41
Enhanced Protection Option.....	44
Chiller Selection .....	45
Fully Customizable Chiller Selection.....	45
Full-Load and Part-Load Performance .....	46
myPLV Chiller Performance Evaluation Tool .....	47
Unit Specifications – Imperial (I-P) Units .....	48
Performance Data .....	48
Weights (lb) .....	52
Physical Dimensions .....	59
Waterbox Lengths .....	65
Unit Specifications – International System (SI) Units .....	70
Performance Data .....	70
Weights (kg) .....	74
Physical Dimensions .....	81
Waterbox Lengths .....	87

Mechanical Specifications .....	92
Compressor .....	92
Evaporator .....	93
Condenser/Heat Recovery Condenser .....	94
Economizer .....	94
Purge System .....	95
Symbio™ 800 Chiller Controller .....	95
Isolation Pads .....	96
Refrigerant and Oil Charge .....	96
0.0% Leak-Tight Warranty .....	96
Thermometer Wells and Sight Glasses .....	96
Insulation .....	96
Refrigerant Pumpout/Reclaim Connections .....	97
Painting .....	97
Unit-Mounted Starter and Adaptive Frequency Drive Options .....	97
Appendix A: Chiller Views .....	98
Appendix B: Evaporator Waterbox Configuration .....	100
Appendix C: Condenser Waterbox Configuration .....	104
Appendix D: Marine Waterbox Arrangement .....	106
Appendix E: CenTraVac Chiller Operating Cycles .....	108
Compressor Motor .....	108
Fixed Orifice Flow Control .....	108
Low Speed, Direct Drive Compressor .....	108
Multiple Stages of Compression .....	109
Inlet Guide Vanes .....	109
Flash Economizer .....	109
Refrigerant/Oil Pump Motor .....	109
Purge System .....	109
Appendix F: CenTraVac Chiller Pressure-Enthalpy (P-H) Diagrams .....	110
Appendix G: Standard Conversions .....	112



# General Information

## Local Support

The performance and reliability of CenTraVac™ chillers is backed by a team of knowledgeable engineers, HVAC systems specialists, and technical professionals. Your local Trane team will see you through the entire chiller bid process, from building analysis to equipment specification and through installation and commissioning.

## Custom Built Unit

Each CenTraVac™ chiller is custom built to meet your specific project requirements, optimizing the configuration based on design parameters such as full- and part-load performance and waterside pressure drops.

## ISO 9001 Certified

The quality management system used by the Trane CenTraVac™ chiller manufacturing facility is the ISO 9001 Standard. This standard documents office, manufacturing, and testing procedures for maximum consistency in meeting or exceeding customer expectations. ISO 9001 requires extensive documentation on how quality assurance activities are managed, performed, and continuously monitored. Included in the system are verification checkpoints from the time the order is entered until final shipment. In addition, product development is subjected to formal planning, review, and validation.

## Certified AHRI Performance

CenTraVac™ chillers are rated within the scope of the Air-Conditioning, Heating & Refrigeration Institute (AHRI) Certification Program and display the AHRI Certified® mark as a visual confirmation of conformance to the certification sections of AHRI Standard 550/590 (I-P) and ANSI/AHRI Standard 551/591 (SI).

The applications in this catalog specifically excluded from the AHRI certification program are:

- Free cooling
- Low temperature applications (below 36°F [2.2°C]), including ice storage
- 60 Hz chillers larger than 3000 tons (10551 kW) and/or greater than 15000 volts
- 50 Hz chillers larger than 3000 tons (10551 kW) and/or greater than 15000 volts
- Heat recovery and heat pump ratings
- Auxiliary condenser
- Glycol and brines

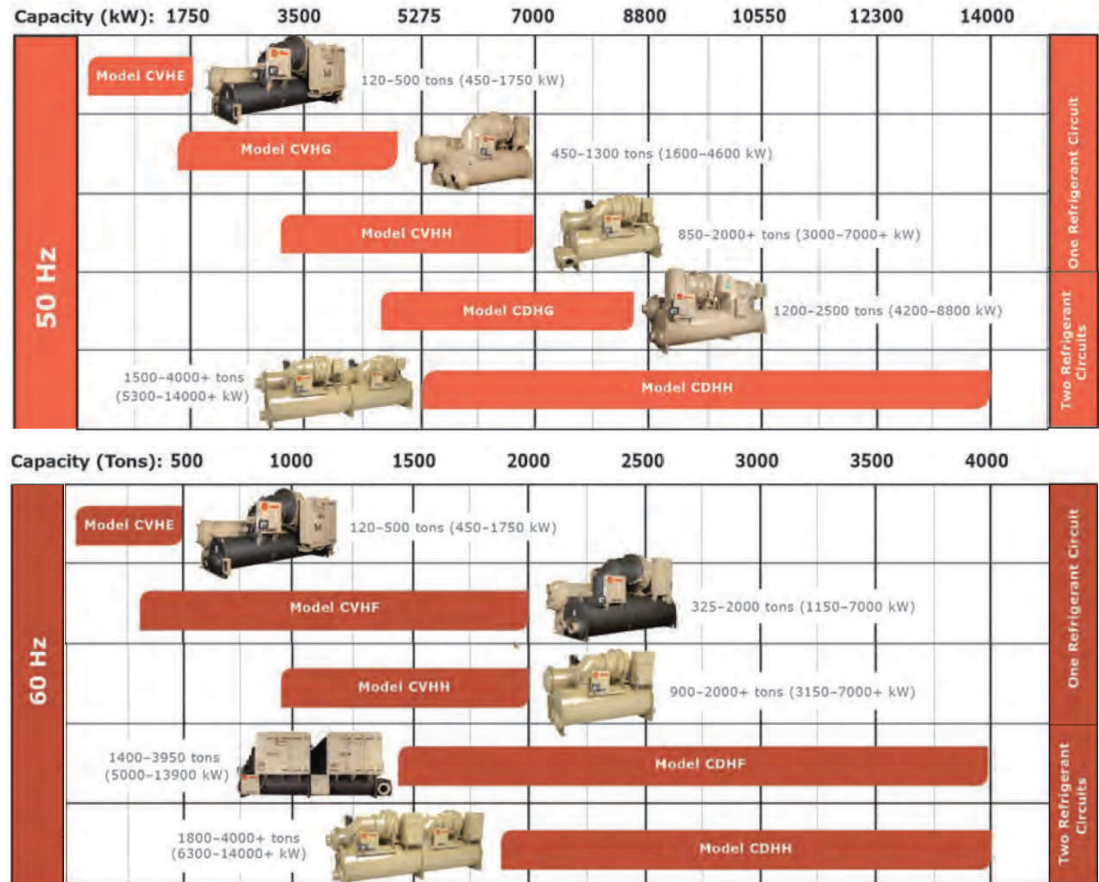
## District Cooling

Trane Adaptive Control™ algorithms and the multi-stage design allow all CenTraVac™ chillers to deliver low leaving chilled water temperatures (e.g., 34°F [1.1°C]) without the use of glycol or other freeze inhibitors. This reduces the cost of delivering cooling capacity over long distances. Pre-engineered CenTraVac™ chiller thermal storage systems extend the chiller's exceptional reliability to the rest of the district cooling plant.

## Turbine Inlet Cooling

Trane chillers are frequently used in conjunction with combustion turbines to increase the power capacity, efficiency, and life of the turbine. Turbine inlet cooling can eliminate the need for inlet water spray to reduce NO<sub>x</sub> emissions. With turbine inlet cooling, plants can delay or even avoid the need for additional turbines because more capacity can be obtained from existing turbines.

# CenTraVac Chiller Portfolio



## Trane Gigaton Challenge

### Our Gigaton Challenge

Uniquely positioned to lead a movement to reduce greenhouse gas (GHG) emissions

#### Accelerate Clean Technologies



CLEAN200™

#66 Corporate Knights Clean200 list of public companies ranked by green revenue

20 million+ metric ton reduction in the use phase emissions of our products since 2014

#### Addressing System Energy Efficiency

##### Holistic Solutions

Connecting, monitoring and automating a building's entire mechanical system to operate in the most efficient way possible

##### Strategic Electrification of Heating

Innovating new solutions to remove fossil fuels on-site and help our customers be resilient in what's set to be a tumultuous decade

#### Reducing Food Loss from Cold Chain

10% of the world's emissions are from the loss or waste of food



Our hunger relief program was developed to help reduce food waste and increase access to fresh, nutritious food for people who need it most

#### Transitioning Out of High GWP Refrigerants

By 2030 we will fully transition out of high GWP refrigerants, ahead of regulation

30+ countries (most of which do not have regulations in place) where our next-generation chillers can be purchased





## Next-Generation Refrigerants

Trane has always taken a balanced approach to selecting refrigerants, considering factors such as safety, sustainability, efficiency, reliability, and overall lifecycle impact. Expanding the CenTraVac™ chiller portfolio to operate with one of two low pressure next-generation refrigerants (R-514A or R-1233zd) enables Trane to continue our commitment as the industry evolves through its next refrigerant transition, from HCFCs and HFCs to next-generation, low-GWP refrigerants.

Low pressure refrigerants have been a key element of the CenTraVac™ chiller design dating back to the very first Trane® centrifugal chiller in 1938. These new models continue the tradition offering a low pressure, leak-tight chiller that delivers best-in-class efficiencies.

CenTraVac™ chillers are available with R-514A. Model CDHH and CVHH chillers offer R-1233zd refrigerant as an option. Classified as an “A1” refrigerant per ASHRAE Standard 34, R-1233zd is one of the few nonflammable olefin options available today. Likewise, R-514A is another next-generation refrigerant with a GWP of less than two.

## Benefits of Low Pressure

Trane CenTraVac™ chillers feature a time-tested and proven low-pressure design utilizing environmentally friendly refrigerants R-514A and R-1233zd. They provide the safety of low pressure with continued product enhancements in leak-tight design. Consider the benefits of a low pressure CenTraVac™ chiller versus medium pressure machines:

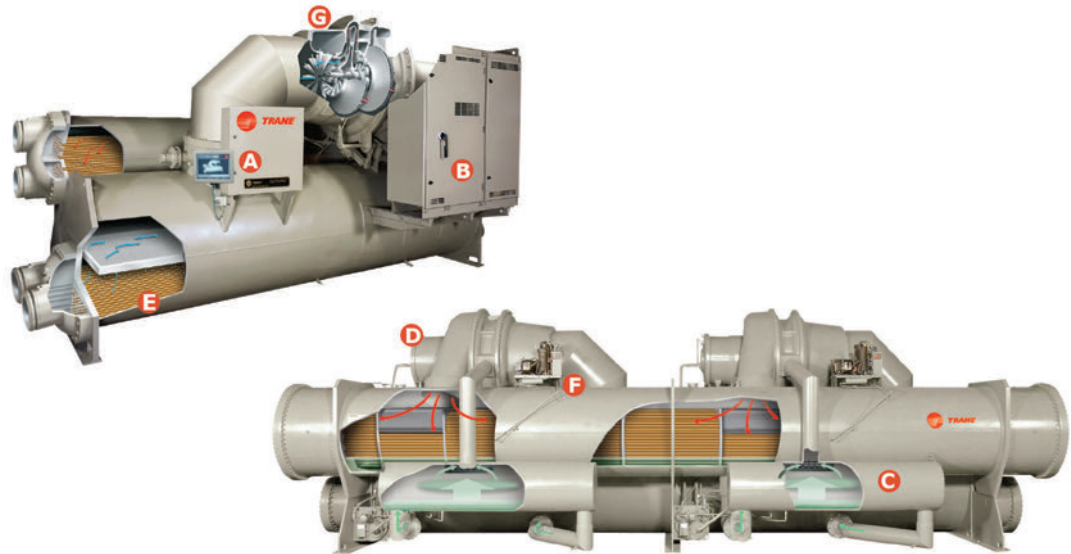
**Table 1. Operating pressure comparison at AHRI conditions**

	Low Pressure	Medium Pressure
Evaporator	<ul style="list-style-type: none"> <li>Always at negative pressure</li> <li>Air leaks inward</li> <li>Refrigerant lost: (# air leak in) x purge efficiency<sup>(a)</sup></li> <li>No refrigerant loss into equipment room</li> </ul>	<ul style="list-style-type: none"> <li>Operates at positive pressure</li> <li>Refrigerant leaks outward at moderate rate</li> <li>Refrigerant loss is difficult to know, performance is degraded</li> <li>Refrigerant loss is into equipment room</li> </ul>
Condenser	<ul style="list-style-type: none"> <li>Usually at neutral to negative pressure during inactivity (air might leak inward)</li> <li>At slightly positive pressure during operation</li> <li>In the event of a leak, refrigerant could leak outward, but at a very low rate</li> </ul>	<ul style="list-style-type: none"> <li>Always at high positive pressure</li> <li>In the event of a leak, refrigerant would leak outward at a very high rate</li> </ul>
Monitoring of leak rate	<ul style="list-style-type: none"> <li>Unit purge is able to continuously monitor in leakage with the run meter, whether the chiller is on or off.</li> <li>Refrigerant monitor as required by ASHRAE.</li> <li>Purge can be connected to a building automation system for notification of increased purge operation (in-leak). Similarly, the BACnet® module allows the refrigerant monitor to be connected to the building automation system.</li> </ul>	<ul style="list-style-type: none"> <li>Only ways to monitor leak rate on medium pressure chiller are:               <ul style="list-style-type: none"> <li>periodic leak checks</li> <li>purchase refrigerant monitor</li> </ul> </li> <li>Refrigerant monitor as required by ASHRAE.</li> <li>Typically, the only time a leak is detected on a medium pressure chiller is during spring start-up. This means that a chiller which develops a leak in the summer may leak continuously until the following spring.</li> </ul>
Typical Pressures Evaporator: 38°F (3.3°C) Condenser: 100°F (37.8°C)	<b>R-514A</b> Evaporator: -9.5 psig (-65.4 kPaG) Condenser: 5.3 psig (36.3 kPaG) <b>R-1233zd</b> Evaporator: -6.6 psig (-45.8 kPaG) Condenser: 14.4 psig (99.3 kPaG)	<b>R-134a</b> Evaporator: 33.1 psig (228.5 kPaG) Condenser: 124.2 psig (856.0 kPaG) <b>R-513A</b> Evaporator: 37.6 psig (259.0 kPaG) Condenser: 130.7 psig (901.2 kPaG) <b>R-1234ze</b> Evaporator: 20.8 psig (143.1 kPaG) Condenser: 89.9 psig (619.8 kPaG)

<sup>(a)</sup> Trane® purge efficiency meets ASHRAE Standard 147, which is less than 1 unit of refrigerant per unit of air.



## Standard Features



The following features are provided as standard with all Trane CenTraVac™ chillers:

**A. Symbio™ 800 Chiller Controller**—Feed Forward Adaptive Control™ is a predictive control strategy designed to anticipate and compensate for load changes via entering water temperatures and flow rates. Control algorithms shorten chiller response time for energy-saving variable pumping strategies. The controller includes a unit-mounted control panel, the main processor, and an intuitive animated operator interface.

**B. Unit Mounted Starters and Adaptive Frequency Drives**—Trane offers a large selection of starters and drives. Trane starters offer standard features for safe, efficient application and ease of installation. Adaptive Frequency™ drives are the industry's most capable variable speed drives, optimizing compressor speed control to reduce energy use.

**C. Flash Economizer**—CenTraVac™ chillers leverage a multi-stage design with two or three impellers, making it possible to flash refrigerant gas at intermediate pressure(s) between the evaporator and condenser. This feature increases chiller efficiency up to 4.5 percent for two-stage chillers and up to 7 percent for three-stage chillers.

**D. Refrigerant Cooled Motor**—All Trane CenTraVac™ chiller motors are cooled by liquid refrigerant surrounding the motor winding and rotor. Using liquid refrigerant in uniform low temperatures prolongs motor life, as to open designs. As an additional benefit, motor heat is rejected out to the cooling tower, helping to keep the equipment room at a desirable temperature.

**E. Low Pressure Design**—Low pressure refrigerants have been a key element of the Trane centrifugal chiller design since 1938. Backed by the Trane 0.0% Leak Tight Warranty, the CenTraVac™ chiller's tight vessel low-pressure operation minimizes the chance for outward refrigerant leaks.

**F. Purge System**—The high efficiency purge system is designed with automatic regeneration capability. When the filter senses that it is full, the regeneration cycle begins, and reclaimed refrigerant is automatically returned to the chiller, keeping the purge's productivity at its peak without the need to exchange carbon canisters. The CenTraVac™ chiller purge system has capability to run even when the chiller is turned off.

**G. Direct Drive Low-Speed Compressor**—The exclusive CenTraVac™ compressor has only one moving part supported by just two bearings, providing reliability through simplicity of design. The low-speed, direct-drive design not only gives the CenTraVac™ compressor the most reliable and efficient operation, but also the lowest sound and vibration levels in the industry. This feature also eliminates the need for costly jacketing and energy-wasting liquid-refrigerant sound attenuation.



## 0.0% Leak-Tight Warranty

### Terms and Conditions

The Company warrants for the lesser of 60 months from initial start-up or 66 months from date of shipment that the CenTraVac™ chiller will be leak-tight against refrigerant loss or the Company will furnish replacement refrigerant (the limited “Leak-Tight Warranty”). The limited Leak-Tight Warranty covers CenTraVac™ chillers (models CDHF, CDHH, CVHE, CVHF, and CVHH) installed in the United States and Canada that ship from the factory in La Crosse, Wisconsin, September 1, 2004 or later. **The Company’s obligations and liabilities under this warranty are limited to furnishing replacement refrigerant; no other parts or labor are covered under this limited warranty.** No liability whatever shall attach to the Company until appropriate actions (acceptable to Company) have been taken to eliminate the source of the leak.

If the chiller is placed under a comprehensive Trane service and maintenance agreement (Trane “Select Agreement” or better) prior to the expiration of the standard Leak-Tight Warranty, the protection against refrigerant loss shall continue under the Trane Select Agreement for as long as an active Trane Select Agreement remains in effect without interruption.

If a 10-Year Parts, Labor and Refrigerant Warranty was purchased for the chiller and the chiller is placed under the Trane Select Agreement (or better) prior to the expiration of the 10-Year Parts, Labor and Refrigerant Warranty, the protection against refrigerant loss shall continue under the Trane Select Agreement for as long as an active Trane Select Agreement remains in effect without interruption.

Any further warranty must be in writing, signed by an authorized representative of the Company.

NOTWITHSTANDING ANYTHING TO THE CONTRARY, IN NO EVENT SHALL THE COMPANY BE LIABLE FOR ANY INCIDENTAL OR CONSEQUENTIAL DAMAGES EVEN IF A PARTY HAS BEEN ADVISED OF SUCH POSSIBLE DAMAGES OR IF SAME WERE REASONABLY FORESEEABLE AND REGARDLESS OF WHETHER THE CAUSE OF ACTION IS FRAMED IN CONTRACT, NEGLIGENCE, ANY OTHER TORT, WARRANTY, STRICT LIABILITY, OR PRODUCT LIABILITY.

## Integrated Rapid Restart

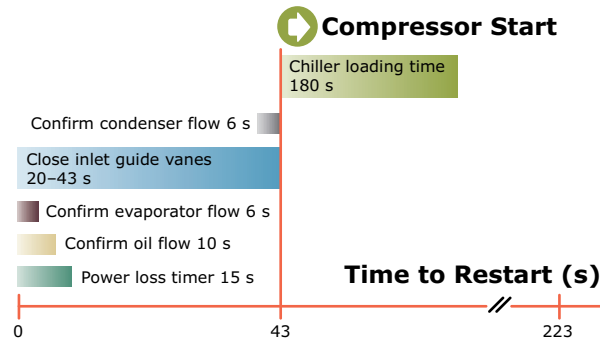
**Note:** Restart times are based on chillers with a electromechanical speed starter. Restart times with a Trane Adaptive Frequency™ Drive (AFD) will vary. Contact your local Trane account manager for more information.

A loss of cooling capacity can be costly, which is why CenTraVac™ chillers are designed to integrate seamlessly with uninterruptible power supplies (UPS) and have the shortest restart times in the industry.

In the event of a power interruption, the chiller defaults to its rapid restart mode, optimizing electrical and mechanical variables, including guide vane position. This not only helps the chiller get back online faster, but it also provides the least amount of load on your building’s electrical infrastructure, which can make a big difference if your building has a backup generator.

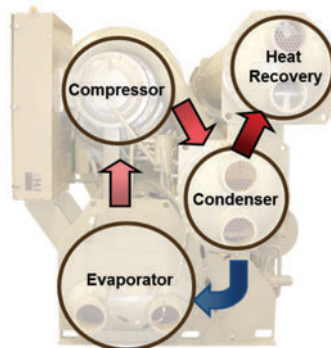
Even under extreme conditions, CenTraVac™ chiller restart times have been verified at as few as 43 seconds, as shown in the following figure. Thanks to fast restart times like these, you can substantially minimize the risks of financially devastating damage to assets caused by overheating due to power outages. Of course, the truest test of a chiller’s restart capabilities is the amount of time it takes to resume full-load cooling, and this is where the CenTraVac™ chiller really shines. An 80 percent cooling load can be achieved in less than three minutes after power restoration—your assurance that the cooling capacity your equipment requires is just a few minutes away.

**Figure 1. Symbio™ 800 restart time after power loss (with UPS)—single compressor CenTraVac chiller models**



1. Restart time shown in this figure assumes chiller starter power restored within 120 seconds.
2. Time to close inlet guide vanes (20–43 seconds) is a function of chiller load.
3. Time to confirm oil flow (10 seconds) is for an oil pump on UPS.
4. Chiller loading time (180 seconds) is the estimated time to 80 percent load.

## Optional Features



*Note: CVHF unit shown.*

### Heat Recovery—Full or Partial

Utilize heat that would otherwise be rejected into the atmosphere

- Improve overall system efficiency
- Reduce ancillary power
- Simplify system controls
- Lower operating costs

For more information, refer to “Full Heat Recovery,” p. 26 and “Partial Heat Recovery,” p. 27.

*Model CVHH use two separate bundles within the same condenser shell.*

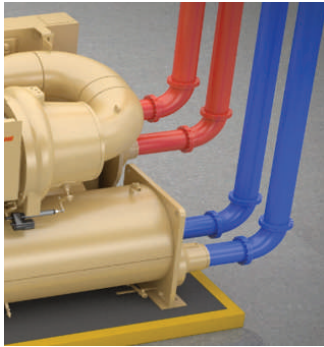


### Free Cooling

Take advantage of cold ambient conditions

- Better system efficiency
- No additional footprint
- Integrated control
- Lower first, install, and maintenance costs
- Predictable performance

For more information, refer to “Free Cooling Option,” p. 22.


**Low Supply Temperature**

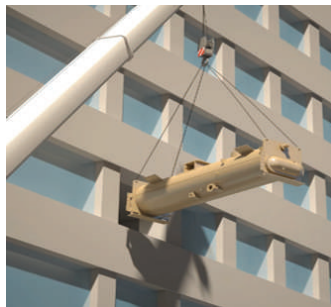
Leaving water down to 34°F (1.1°C) without glycol

- Eliminate energy wasting glycol
- Simplify system design
- Increase capacity of existing distribution system


**Thermal/Ice Storage**

Take advantage of low cost energy

- Manage energy costs
  - Reduce demand charges
  - Shift system load demand
  - Stability of cooling capacity
  - Dual-duty operation
- For more information, refer to [“Thermal/Ice Storage,” p. 30.](#)


**Separable Shells**

Bolt together design allows for chiller break down

- Ease of installation for existing buildings


**Enhanced Flow Management**

Maintain stable, precise, capacity control

- Operate chiller at greater variable evaporator flows
- Tighten leaving temperature control
- Minimize variable-flow disturbance
- Maintain control stability at low flow

For more information, refer to [“Optional Enhanced Flow Management Package,” p. 36.](#)


**Enhanced Electrical Protection**

Enhance the CenTraVac™ chiller's already robust design:

- Features modified controls and electrical components
- Operate in hazardous or sensitive environments
- Includes operator safeguards and chiller protection
- Meets intent of NEMA 12

For more information, refer to [“Enhanced Electrical Protection Package Option,” p. 21.](#)

**Thermal Insulation**

Prevent condensation on chiller shells

- Available in two thicknesses: 0.75 in. (19 mm) and 1.5 in. (38 mm)
  - Provides flexible thermal barrier
  - Manufactured without the use of CFC, HCFC, or HFC
  - Low VOCs, fiber free and resistant to mold
- For more information, refer to [“Insulation,” p. 96.](#)

**Adaptive Frequency Drive**

Lower chiller power consumption

- Most reliable and lowest maintenance drive
  - Optimize chiller efficiency
  - Total Demand Distortion (TDD) down to 5 percent
  - Direct to drive technology
  - Integrate with Trane chiller controls
- For more information, refer to [“Adaptive Frequency Drive,” p. 17.](#)

**Waterbox Options**

Trane provides an extensive selection of waterboxes for your specific application

- One-, two-, or three-pass evaporator configurations
  - Standard and marine available
  - Victaulic® or welded raised face flanges
  - Hinged waterbox options
  - CSE-6100 Series Epoxy Phenolic Coating and anodes available
- For more information, refer to [“Appendix B: Evaporator Waterbox Configuration,” p. 100](#) and [“Appendix C: Condenser Waterbox Configuration,” p. 104.](#)

**Factory Testing**

Validate performance under operating conditions

- Ensure chiller’s actual performance matches predictions
  - Prove performance under special conditions, like variable primary flow, free cooling, rapid restart and more
  - Visit Trane® manufacturing facility in La Crosse, Wisconsin for a factory hosted Witness Test
  - Watch testing in the comfort of your office with the new Remote Witness Test option
- For more information, refer to [“Factory Performance Testing,” p. 14.](#)

**Special Tube Options**

Customize evaporator heat transfer surface for specific applications

- Available in 1 in. (25 mm) or 0.75 in. (19 mm) diameters
- Choose from standard copper to cupronickel, stainless steel, or titanium
- From ultra-high efficiency to low fouling or even smooth-bore
- Range of tube wall thicknesses (0.025 in. to 0.035 in. [0.635 mm to 0.889])



# Unit Options

## Factory Performance Testing

CenTraVac™ chillers that fall within the scope of the AHRI Standard 550/590 (I-P) and ANSI/AHRI Standard 551/591 (SI) Certification Process bear the AHRI seal. All other CenTraVac™ chillers, and the selection software itself, are rated in accordance with the Standard. Performance testing is a key part of this program. Factory performance tests confirm that your chiller’s actual performance matches what was predicted during the selection process, before the chiller is installed.

Standard AHRI tests are a well-recognized industry practice; however, a chiller’s operating conditions vary significantly based on the needs of the building and its occupants. Data centers, hospitals, and retail locations all have specific requirements unique to their application and location. The Trane myTest™ program offers a fully customizable portfolio of chiller test packages and proof-of-performance options, in addition to standard AHRI tests. All tests and demonstrations are done in accordance with AHRI Standard 550/590, and the testing equipment is calibrated and validated by the National Institute of Standards Technology (NIST).

AHRI allows for standard tolerances in its certified selections; however, some customers may require tighter tolerances. Selecting and testing to zero tolerance requirements ensures that the full capacity and performance benefit are realized.

## Trane Starters and Drives

### A Wide Array of Low- and Medium-Voltage Starters

Trane offers a comprehensive portfolio of electromechanical starters and frequency drives for low-voltage and medium voltage chiller applications. [Table 2, p. 14](#) presents a summary of the starters and drives available at these applications.

The selection program chooses the correct starter or frequency drive based on chiller amperage. [Table 5, p. 30](#) provides a summary of the starters and frequency drives available at the two voltage classes. When referring to frequency drives, Trane has trademarked the term Adaptive Frequency™ drive (AFD) to describe the unique control algorithms used to optimize chiller efficiency while operating at variable speeds. For more detailed information on all electrical topics including starters and AFDs, refer to CTV-PRB004\*-EN (*Engineering Bulletin: Frequency Drives, Starters and Electrical Components for CenTraVac Chillers*).

**Table 2. Trane CenTraVac™ chiller starter and drive choices**

Low Voltage (208–600V) <sup>(a)</sup>		Medium Voltage (2300–6600V)		Medium Voltage (10000–13800V)
Remote-Mounted	Unit-Mounted	Remote-Mounted	Unit-Mounted	Remote-Mounted
<b>Wye-Delta</b> <ul style="list-style-type: none"> <li>Circuit breaker option</li> </ul>	<b>Wye-Delta</b> <ul style="list-style-type: none"> <li>Circuit breaker option</li> </ul>	<b>Across-the-Line</b> <ul style="list-style-type: none"> <li>Isolation switch, power fuses standard</li> </ul>	<b>Across-the-Line</b> <ul style="list-style-type: none"> <li>Isolation switch, power fuses standard</li> </ul>	<b>Across-the-Line</b> <ul style="list-style-type: none"> <li>Isolation switch, power fuses standard</li> </ul>
		<b>Primary Reactor</b> <ul style="list-style-type: none"> <li>Isolation switch, power fuses standard</li> </ul>	<b>Primary Reactor</b> <ul style="list-style-type: none"> <li>Isolation switch, power fuses standard</li> </ul>	<b>Primary Reactor</b> <ul style="list-style-type: none"> <li>Isolation switch, power fuses standard</li> </ul>
<b>Adaptive Frequency™ Drive (AFD)</b> <ul style="list-style-type: none"> <li>Circuit breaker standard</li> </ul>	<b>Refrigerant-Cooled AFD</b> <ul style="list-style-type: none"> <li>Circuit breaker standard 380–480V</li> </ul>	<b>Autotransformer</b> <ul style="list-style-type: none"> <li>Isolation switch, power fuses standard</li> </ul>	<b>Autotransformer</b> <ul style="list-style-type: none"> <li>Isolation switch, power fuses standard</li> </ul>	<b>Autotransformer</b> <ul style="list-style-type: none"> <li>Isolation switch, power fuses standard</li> </ul>
	<b>Air-Cooled AFD</b> <ul style="list-style-type: none"> <li>Circuit breaker standard 460–480V</li> </ul>	<b>AFD</b> <ul style="list-style-type: none"> <li>Isolation switch, power fuses standard</li> </ul>		

<sup>(a)</sup> Models CDHH and CVHH Low Voltage (380–600V)

## Overview, Standard and Optional Features

All factory-installed or remote-mounted starters provided by Trane offer the following standard features for safe, efficient application and ease of installation:

### Standard Features

- NEMA 1 starter enclosure.
- Starter enclosures capable of being padlocked (unit-mounted wye-delta starters).
- 120 volt, 60 hertz, 1-phase fused pilot and safety circuits.
- Control power transformer (4 kVA) producing 120V, 60 and 50 Hz, single-phase. This provides auxiliary power for all chiller-mounted devices (except remote-mounted medium-voltage AFDs and customer-supplied starters).
- Control power transformer and oil pump motor circuit (models CDHH and CVHH):
  - 60 and 50 Hz low voltage units: 4 kVA single phase control power transformer to provide power for all chiller-mounted control devices (except remote-mounted medium-voltage AFDs and customer-supplied starters) with 120V secondary voltage and 3-phase line voltage 380–600 Vac to provide power to the three-phase oil pump motor circuit.
  - 60 and 50 Hz medium voltage units: 8 kVA single phase control power transformer with dual secondary voltage to provide power for all chiller-mounted control devices (except remote-mounted medium-voltage AFDs and customer-supplied starters) with 120V secondary voltage and 200–240V secondary voltage to provide power to the single phase oil pump motor circuit.
- Three-phase incoming line terminals.
- Six output load terminals for low-voltage starters (at or below 600 Vac), three output load terminals for medium voltage (greater than 600 Vac). Unit-mounted starters are factory-connected to the motor.
- Automatic closed-transition transfer from wye to delta on any two-step starter (unit-mounted).
- One pilot relay to initiate start sequence from CenTraVac™ chiller control circuit signal.

### Optional Features

- Ground fault protection.
- Digital metering devices.
- Surge protector/lighting arrestor.
- Standard and high interrupt circuit breakers that are mechanically interlocked to disconnect line power when the starter door is open.
- Special NEMA enclosures.
- Analog ammeters and voltmeters.

### Advantages of Factory-Installed Starters

- Enhance electrical system reliability
- Reduce starter installation costs 20–35 percent
- Decrease required equipment room floor space
- Optimize control of motor and compressor
- Provide factory-quality control of the starter-to-chiller electrical connections
- Reduce system design time with pre-engineered starter components and interconnecting wiring

### Standard Motor Protections

Trane provides the key motor protection and metering functions within the chiller microprocessor control panel as standard. Having the motor control and chiller control in one panel provides better integration and optimization of the two control systems. For example, the chiller controller can unload the chiller when approaching an overload “trip” point, so that the chiller stays online.

The standard motor protections include:

- Overload protection
- Long acceleration protection
- Motor overheat protection
- Momentary power loss protection (distribution fault)
- Phase failure/loss protection
- Phase imbalance protection

- Phase reversal protection
- Under/overvoltage protection
- Short cycling protection

## Low Voltage Starter and Adaptive Frequency Drive Options

The following table shows the most common low-voltage starter and Adaptive Frequency™ drive types, and lists advantages and disadvantages of each.

**Table 3. Comparison of low-voltage starter and drive types**

Starter Type (closed-transition)	Inrush Current % LRA	Percent Rated Torque	Advantages	Disadvantages	Typical Acceleration Time (seconds)
<b>Constant Speed</b>					
Wye-Delta (Star-Delta)	33	33	<ul style="list-style-type: none"> <li>• Equal reduction of torque and inrush current</li> <li>• Simple, easy to service and maintain</li> <li>• Lower cost</li> </ul>	<ul style="list-style-type: none"> <li>• Only applicable up to 600V</li> <li>• Small "spike" at transition</li> </ul>	5–12
<b>Variable Speed</b>					
Adaptive Frequency Drive (AFD)	<13 (<RLA)	Varies	<ul style="list-style-type: none"> <li>• Lowest inrush current</li> <li>• Better chiller efficiency at reduced lift</li> </ul>	<ul style="list-style-type: none"> <li>• Most expensive</li> <li>• Efficiency losses at full load</li> <li>• Harmonics may be an issue</li> </ul>	8–30

Conventional chillers use inlet guide vanes to provide stable operation at part-load conditions. Capacity is reduced by closing the vanes while maintaining a constant motor speed. A variable speed drive can be used to maximize chiller efficiency and reduce power consumption by adapting the compressor motor speed and inlet guide vanes to the chiller operating temperatures.

### Wye (Star) Delta Starter

One of the most common starters in the industry is the wye (star)-delta. It is an air-cooled electromechanical starter initially set up in a "wye" or "star" configuration, which then transitions to a "delta" configuration during the starting sequence. In the wye configuration, the voltage applied to the motor windings is reduced, resulting in a reduction in the inrush current. The inrush current is 0.33 times the full voltage locked rotor current rating of the motor. The accelerating torque of the motor is also reduced to 33 percent of the full-voltage torque rating, which is sufficient to fully accelerate the compressor motor. During acceleration, when the line current drops to approximately 0.85 times rated load current, transition is initiated. With the completion of transition, the motor windings are connected in the delta configuration with full line voltage. This starter type can be selected as either a unit- or remote-mounted option.



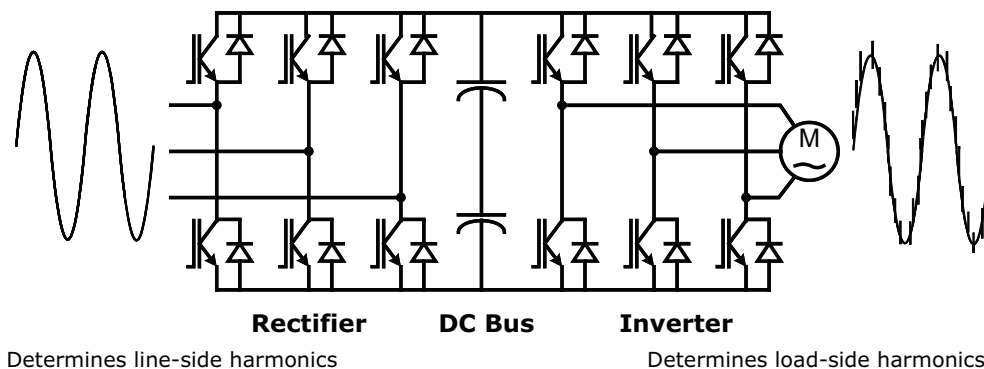
## Adaptive Frequency Drive

An Adaptive Frequency™ Drive (AFD) may be used in lieu of a constant speed starter. Adaptive Frequency™ is the trademarked term for a Trane® variable frequency drive (VFD) which is made to Trane specifications and uses proprietary control logic. The primary purpose of a VFD is to reduce energy consumption by changing the speed of the motor, but other benefits include improved power factor and soft starts.

The combination of speed control and inlet guide vane (IGV) position is optimized mathematically and controlled simultaneously. The Adaptive Control™ microprocessor controller allows the chiller to operate longer at higher efficiencies and with greater stability.

The AFD regulates output voltage in proportion to output frequency to maintain ideal motor flux and constant torque-producing capability. It controls load-side frequency and voltage to adjust the compressor motor speed. The AFD is a voltage-source, pulse-width modulated (PWM) design. It consists of three primary power sections as shown in the following figure: the active rectifier, the DC bus, and the inverter.

**Figure 2. AFD power sections**



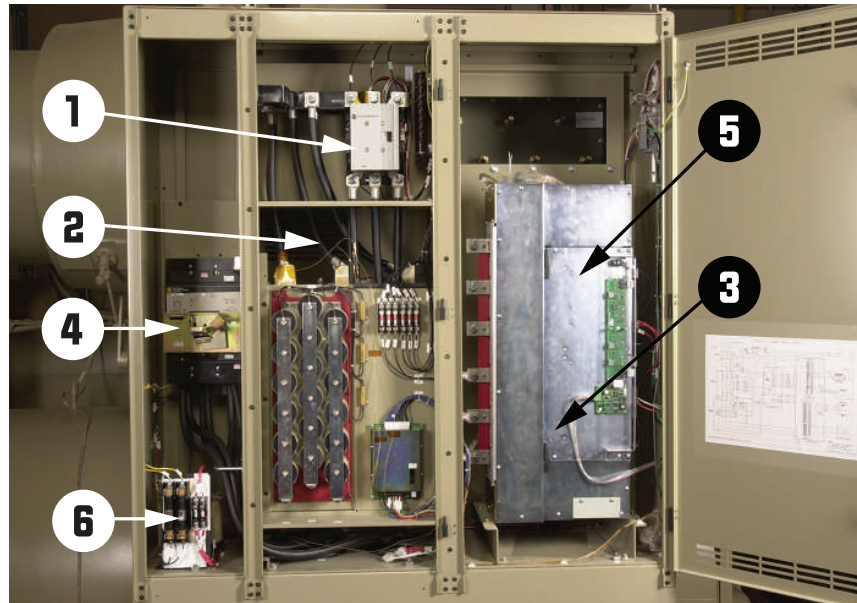
Trane offers four low voltage options:

**Unit-mounted refrigerant-cooled AFD with full harmonic attenuation**—Available for use with 460/480V 60 Hz or 380–415V 50 Hz. This drive features an active rectifier to filter incoming AC power and convert it to a fixed DC voltage and meets the less than 5 percent total demand distortion (TDD) as standard, without the need for additional line-side filters to meet IEEE harmonic requirements.

**Compact unit-mounted air-cooled AFD**—This low profile AFD has a DC choke that minimizes harmonic distortion and results in a TDD of approximately 30 percent. Available for CVHE and CVHF models, 120 to 500 tons, 460/480V and 575/600V 60 Hz input power,  $\pm 10$  percent.

**Remote (free-standing) air-cooled AFD**—The remote AFD comes as a complete, free-standing package that includes the necessary controls, control power and programming needed for operation. Input voltage options include 460, 480, 575, and 600V. The remote AFD has as standard a 5 percent link reactor to help minimize harmonics, however it is a 6-pulse AFD which means the TDD is ~30 percent.

**Figure 3. Typical AFD layout (unit-mounted, refrigerant-cooled AFD)**



1. Pre-charge contactor
2. Inductor (behind the panel)
3. Adjustable-speed drive (inverter)
4. Circuit breaker (standard)
5. Active rectifier
6. 3 kVA control-power transformer

### **IEEE Standard 519 Harmonic Filter and Transformer Options**

It is important to recognize that the IEEE Standard 519 as a guideline relates to the entire system, not specifically to any one load or product. IEEE Standard 519 establishes requirements at the point of common coupling (PCC) where the building connects to the utility system. The Standard contains no specific requirements for the internal electrical loads. Even though a Trane® AFD-equipped chiller may attenuate its own harmonics, other non-linear loads on the same system may still create harmonic problems. In buildings where harmonics might be a concern, Trane recommends conducting a power-distribution system analysis to determine if there is a need to further attenuate harmonics at the system level.

### **Application of Drives on Chillers**

Certain system characteristics favor installation of an AFD because of energy cost savings and shorter payback. These systems include:

- Condenser water temperature relief (colder than design temperatures)
- Chilled-water reset
- Utilities with high kWh and low kW demand rates

### **Condenser Water Temperature Relief or Chilled-Water Reset**

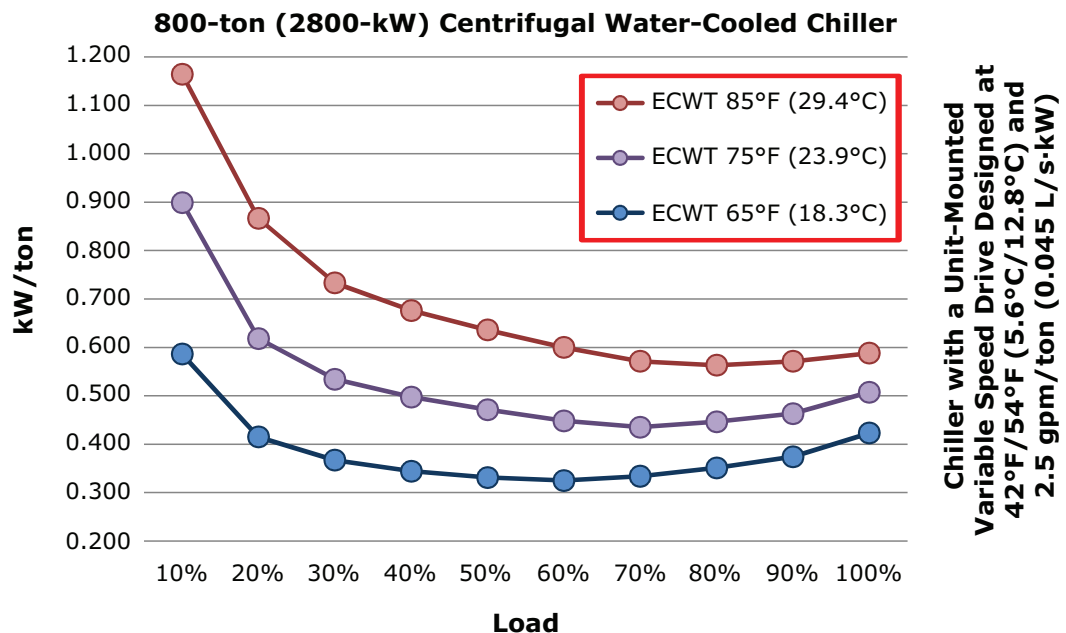
Compressor lift reduction is required for a VFD chiller application, both to provide stable chiller operation and to achieve greater energy savings. A reduction in lift, also referred to as "relief," assumes colder entering condenser temperatures compared to the design entering temperature. Intelligent control to reduce condenser water temperature, or chilled-water reset strategies, are key to VFD savings in chiller system applications. Many believe that VFDs offer better efficiency at part load because part load values are often reported assuming condenser relief. A VFD can incrementally improve efficiency over a constant speed chiller at any load if you have substantial hours with reduced entering condenser water temperatures.

### High Operating Hours with Relief

The following figure is based on an 800-ton (2800-kW) chiller at 42°F/55°F (5.6°C/12.8°C) in the evaporator, and 85°F (29.4°C) entering condenser water temperature, and 2.5 gpm/ton (0.045 L/s-kW) of flow. Three lines are plotted (ECWT at 85°F [29.4°C], 75°F [23.9°C], and 65°F [18.3°C]); the y-axis is kW/ton and the x-axis is chiller percent load.

First, note the unloading curve with the 85°F (29.4°C) entering condenser water—this would be considered unloading with no relief. Then compare this curve with next two curves showing unloading with relief at 75°F (23.9°C) and 65°F (18.3°C), respectively. Note that efficiency improves significantly independent of the chiller load. This is why AFDs should be applied when there are significant hours of operation during which the condensing temperature is reduced.

**Figure 4. Unloading curves with AFD chiller and 85°F (29.4°C), 75°F (23.9°C), 65°F (18.3°C) ECWT temps**



### High kW Demand Charges

Electric utility bills typically include both peak-based and consumption-based components. The demand or distribution charges are significant portions of the energy bill, even in deregulated markets. These charges are established by usage during utility peak hours, by individual peak usage, or a combination of peak and individual usage. This portion may or may not be influenced by installation of a VFD, because a VFD-equipped chiller draws more power at full load. If the peak chiller load coincides with utility peak hours, then the peak-based portion of the utility bill will increase. The energy or kWh portion will almost certainly be reduced because of the improved efficiency of the chiller plant during part-load and part-lift conditions throughout the year. The greater the kWh charge, and the smaller demand or distribution charges, the shorter the payback.

### Medium-Voltage Starter Options

The following table shows the most common medium-voltage starter types and the advantages and disadvantages of each.

**Table 4. Comparison of medium-voltage starter types**

Starter Type (closed-transition)	Inrush Current % LRA	Percent Rated Torque	Advantages	Disadvantages	Typical Acceleration Time (seconds)
<b>Constant Speed</b>					
Across-the-Line (Full Voltage)	100	100	<ul style="list-style-type: none"> <li>• Low cost</li> <li>• Least complex</li> <li>• Least maintenance</li> </ul>	<ul style="list-style-type: none"> <li>• Draws highest inrush current at start-up</li> </ul>	3–5
Primary Reactor 65% TAP	65	42	<ul style="list-style-type: none"> <li>• Good compromise between first cost and reduced inrush current</li> </ul>	<ul style="list-style-type: none"> <li>• More expensive than Across-the-Line</li> <li>• Larger than Across-the-Line</li> </ul>	5–12
Autotransformer 65% TAP	45	42	<ul style="list-style-type: none"> <li>• Almost equal reduction of torque and inrush current</li> <li>• Lowest inrush current</li> </ul>	<ul style="list-style-type: none"> <li>• More expensive than Primary Reactor</li> <li>• Larger than Across-the-Line</li> </ul>	5–12
<b>Variable Speed</b>					
Adaptive Frequency Drive (AFD)	<13 (<RLA)	Varies	<ul style="list-style-type: none"> <li>• Efficiency at part lift</li> <li>• Power factor</li> </ul>	<ul style="list-style-type: none"> <li>• Most expensive</li> <li>• Large and heavy</li> <li>• Complex</li> </ul>	5–12

The AMPGARD® medium-voltage starter family by Eaton Cutler-Hammer®, built to Trane specifications, is available as a factory-installed option for use with CenTraVac™ chillers. Trane mounts, wires, and tests 2300–6600V unit-mounted starters (higher voltages are remote-mount only) at the factory, so you don't have to. This reduces, or eliminates altogether, the time, expense, and any added risk associated with having the starter installed and wired at the job site.

Medium-voltage starters have traditionally been freestanding due to their large size and weight. With advances in contactor technology and component layout, medium-voltage starters have become small enough to make unit-mounting feasible. When this is done, the starter becomes an integral part of the chiller, saving on equipment floor space.

### Across-the-Line (Full Voltage)

An across-the-line starter is the smallest medium-voltage starter option. These starters draw the highest inrush current at starting line up (100 percent of locked rotor amp or LRA), and have the shortest acceleration time (3-5 seconds).

### Primary Reactor

Primary reactor type starters have an inrush current draw of 65 percent of LRA at start-up. Their acceleration time (3–8 seconds) is slightly higher than an across-the-line starter.

### Autotransformer

Autotransformer starters have the lowest inrush current draw of 45 percent of LRA at start-up. They have an acceleration time of 3–8 seconds.

### Standard Features

- Models CDHH and CVHH: UL listed
- Factory-installed (unit-mounted only)
- Non-load-break isolation switch and current limiting fuses
- NEMA Class E2 fused interrupting ratings
  - 200 MVA @ 3000V
  - 400 MVA @ 4600V
  - 750 MVA @ 6600V
- Voltage range of 2300–6600 Volts (unit-mounted)
- Types: Across-the-line (full voltage), primary reactor, autotransformer

- Phase voltage sensors for kW, volts/phase protection, under/overvoltage
- Eaton Cutler-Hammer® AMPGARD®, designed and built to Trane specifications

### Optional Features

- IQ150 and IQDP 4130 electrical metering packages
- Ground fault protection
- Factory-installed power factor correction capacitors sized specific to the motor, factory-wired and mounted inside the starter
- Models CDHH and CVHH: CE-compliant per EU directives and IEC standards
- Models CDHH and CVHH: When a starter-mounted control power transformer is selected, it will have an oil pump motor circuit to drive the single phase oil pump motor

### Starter by Others

If the CenTraVac™ chiller starter will be provided by another manufacturer, the starter must be designed in accordance with the current Trane Starter by Others engineering specification. The system designer and installer are responsible for providing proper starting and control systems.

If another manufacturer's starter will be used with a CE-marked chiller (models CVHH and CDHH only), the system designer/engineer and installer are responsible for ensuring that both the starter and the wiring/connections between the starter and the chiller and the wiring connections into the starter itself meet all applicable CE/IEC standards including CE/IEC EMC standards.

### Enhanced Electrical Protection Package Option

The Enhanced Electrical Protection Package is an option for both low and medium voltage CenTraVac™ chillers. Chillers with this option feature modified controls and electrical components to comply with more stringent industrial demands. The chiller construction meets the intent of NEMA 12 with completely enclosed wiring in seal-tight conduits and polycarbonate junction boxes. All warning markings and wire components have phenolic (permanent) labels. This option includes a control panel with screw-type control terminal-block connections. The purge is also upgraded to meet the intent of NEMA 12, including gasketed seal-tight conduits for electrical and control wiring, sealed motor terminal box, and a totally enclosed fan-cooled (TEFC) motor.

**Note:** *The control panel, purge panel, junction boxes, terminal boxes, wiring/conduit and conduit connections do NOT have an environmental NEMA 12 rating on them. The chiller, itself, is still NEMA 1 rated and can only be used indoors. Even with the Enhanced Electrical Protection Package option, these units are not rated to be hosed down with water.*

When the Enhanced Electrical Protection Package is selected, there are additional options available, which can be applied to remote-mounted medium-voltage starters, both from Trane and from other starter manufacturers.

### Control Power Transformer (CPTR) Option for Low- and Medium-Voltage Starters

Models CDHF, CDHG, CVHE, CVHF, and CVHG: Unit-mounted, factory-wired, separate enclosure mounted next to the control panel with:

- Flanged disconnect
- Secondary fuse status indicator (blown or not-blown)
- Fused primary and secondary power
- UL 508 tested Type 12 construction
- 4 kVA control power transformer (480 to 115 volts)

Models CDHH and CVHH: The CPTR option allows the customer to bring in a clean, dedicated/independent source of power to power the controls and oil pump motor. When this option is selected, the control power transformer and oil pump motor circuit are located in a separate enclosure mounted on the chiller itself, outside of the starter or drive panel, and includes the following:

- Flanged disconnect
- Three-phase customer connection with fused primary (380–600 Vac) and secondary (107–120 Vac) voltage for powering the controls and secondary voltage of 200–240 Vac for medium-voltage applications to power the single phase oil pump motor.
- UL 508A/CE construction



The CPTR option may be selected for either low voltage or medium voltage chillers:

- The low-voltage CPTR option includes a 4 kVA control power transformer and is used with the 3-phase oil pump motor.
- The medium-voltage CPTR option includes two 4 kVA control power transformers and is used with the single phase oil pump motor.

Please note that a control power transformer is always required for the chiller and is standard inside the Trane® AFD/starter for all units except for those configured with a customer-supplied starter or a medium voltage AFD. The CPTR option is sometimes a selectable option and, in some instances, a required item. Please contact your local Trane account manager with any questions.

### Supplemental Motor Protection (SMP) on Medium-Voltage Starters Only

Unit-mounted, factory-wired, separate enclosure mounted to the motor with:

- Surge capacitors
- Field-accessible terminal block for trouble-shooting via panel
- Lightning arrestors
- Zero-sequence ground fault
- UL 347 tested Type 12 construction

### Differential Motor Protection (DMP) on Medium-Voltage Starters Only

Models CDHF, CDHG, CVHE, CVHF, and CVHG: The DMP option includes all of the SMP features except that a flux summation self-compensating differential protection scheme is used instead of the zero-sequence ground fault to remove the line power more quickly and more precisely during a fault.

**Note:** DMP is available only for 1062 kW and larger motor sizes up to 5000 volts.

### Customer-Supplied Vacuum Circuit (CVAC) Breaker on Medium-Voltage Starters Only

Models CDHF, CDHG, CDHH, CVHE, CVHF, CVHG, and CVHH:

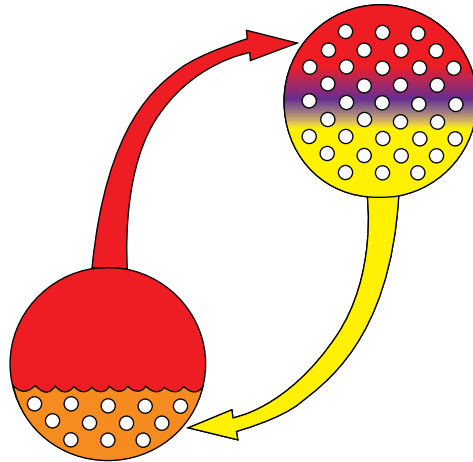
- Three-pole disconnect
- Relays for vacuum circuit-breaker starter type
- Industrial terminal block
- Secondary 120 to 30 volt power transformers (for medium-voltage units)

### Free Cooling Option

The Trane patented free cooling option for CenTraVac™ chillers adapts the basic chiller so it may function as a simple heat exchanger using refrigerant as the working fluid. A free cooling CenTraVac™ chiller can provide cooling without running the compressor, enabling significant energy and cost savings in many situations. For example, it may be possible to cool a building with a high cooling load located in a climate with cold winters exclusively with free cooling during three to six months of the year. In this case, the free cooling payback can easily be less than a year. Additionally, unlike a plate-and-frame heat exchanger solution, this factory-installed option requires no additional floor space or piping beyond the standard CenTraVac™ chiller.

The free cooling cycle is based on the principle that refrigerant migrates to the area of lowest pressure. When the condenser water is at a lower temperature than the chilled water, the refrigerant pressure will also be lower in the condenser than in the evaporator. This pressure difference causes refrigerant to boil in the evaporator and migrate to the condenser. The refrigerant returns to a liquid state in the condenser and flows by gravity back to the evaporator. This completes the refrigerant flow cycle, which can be repeated as long as a temperature/pressure difference exists. The temperature differential between the evaporator and condenser determines the rate of refrigerant flow, and therefore, the cooling capacity delivered. The greater the temperature difference, the greater the cooling capacity—up to 45 percent of the nominal chiller capacity. When the free cooling cycle can no longer provide sufficient capacity to meet cooling requirements, mechanical cooling is restarted automatically by the unit control panel.

**Figure 5. Free cooling schematic**



## Benefits

When condenser water is available at temperatures lower than the desired chilled water temperature, free cooling can provide up to 45 percent of nominal chiller capacity without operation of the compressor. Besides substantial energy cost savings, this Trane solution provides:

- Single-Source Responsibility: Trane-engineered, -manufactured, and -installed.
- Ease of Installation: Completely factory-installed and leak-tested, with factory-wired valves and controls.
- Ease of Operation: Changeover to/from free cooling automatically or by single switch control.
- Reliability: Two simple valves are the only moving parts.

## Application

Modern buildings often require some form of year-round cooling to handle interior zones, solar loads, or computer loads. As the outside air temperature falls below the inside air temperature, it is often possible to use an outside air economizer to satisfy the cooling requirements. There are many situations, however, in which a free cooling CenTraVac™ chiller offers advantages over the use of an outside air economizer. It is possible for the free cooling chiller to satisfy the cooling load for many hours, days, or months during the fall, winter, or spring seasons without operation of the compressor motor. This method of satisfying the cooling requirement can result in significant total energy savings over other types of systems. The savings available are most easily determined through the use of a computer energy analysis and economic program, such as TRACE™ (Trane Air Conditioning Economics).

The suitability of free cooling for any particular installation depends upon a number of factors, including the temperature and quality of the outside air, the availability of cold condenser water, the type of airside system, the temperature and humidity control requirements, and the cost of electricity.

**Temperature and quality of the outside air**—In general, locations that have a substantial number of days with ambient temperatures below 45°F (7.2°C) wet bulb or more than 4000 degree days per year are well suited to free cooling operation. Additionally, a free cooling CenTraVac™ chiller may be a better solution than an outside air economizer in areas that have fouled air.

**Availability of cold condenser water from a cooling tower, river, lake, or pond**—A cooling tower must be winterized for offseason operation and the minimum sump temperature is limited by some cooling tower manufacturers. Cooling tower manufacturers should be consulted for recommendations on low temperature operation. With river, lake, or pond supply, condenser water temperatures down to freezing levels are possible.

**Type of airside system**—Airside systems like dual-duct, multi-zone and reheat systems which heat and cool the air can often effectively use a free cooling chiller. With an outside air economizer, as the outside temperature begins to fall, the cool outside air satisfies the cooling requirements. But, as the outdoor air temperature becomes very low, the outdoor air may need to be heated in order to maintain the design supply air temperature when it is mixed with return air. This “heating penalty” can be eliminated by using free cooling CenTraVac™ chiller. Warmer chilled water provided by the free cooling

chiller would allow a warmer air temperature off the chilled-water coils, eliminating the heating energy required by an outside air economizer. With the high cost of electricity in most areas of the country, the heating penalty of an outside air economizer can be very significant.

**Temperature and humidity control requirements**—Low temperature outside air from an outside air economizer often requires a large amount of energy for humidification, which can often be reduced with a free cooling chiller. However, applications which require extremely precise humidity control typically cannot tolerate the warmer-than-design chilled-water temperatures delivered by a free cooling chiller. Likewise, free cooling is not used in conjunction with heat recovery systems, since mechanical cooling must be used to recover heat that will be used elsewhere in the building for simultaneous heating.

## Operation

Free cooling operates on the principle that refrigerant flows to the area of lowest pressure in the system. The Chiller Plant Control (CPC) application in the Tracer® SC system controller can be used for automatic free cooling control. When condenser water is available at a temperature lower than the required leaving chilled-water temperature, the CPC starts the free cooling cycle. If the load cannot be satisfied with free cooling, the CPC or a customer-supplied system can automatically switch to the powered cooling mode. If desired, the chiller can be manually switched to the free cooling mode at the unit control panel. Upon changeover to free cooling, the liquid and gas line shutoff valves are opened and a lockout circuit prevents compressor energization. Liquid refrigerant drains from the storage tank (except models CDHH and CVHH) into the evaporator, flooding the tube bundle. Because of the water temperature difference, the refrigerant temperature and pressure are higher in the evaporator than in the condenser, so the refrigerant gas that boils off in the evaporator will flow to the condenser. The refrigerant then condenses and flows by gravity back to the evaporator. This free cooling cycle is sustained as long as a temperature difference exists between the condenser and evaporator water; it is this difference that determines the rate of refrigerant flow between the two shells and hence the free cooling capacity.

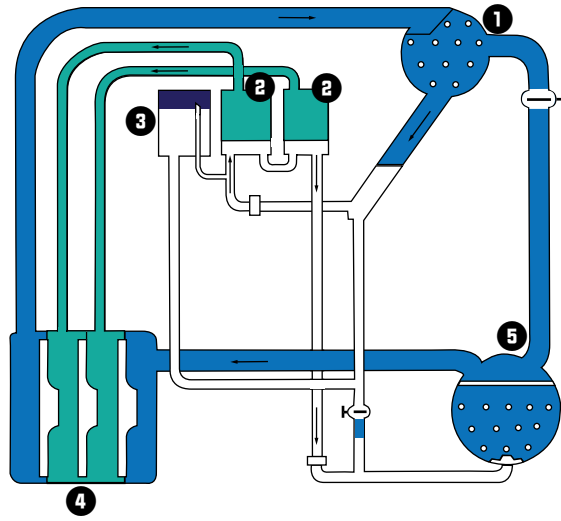
If the system load becomes greater than the free cooling capacity, free cooling operation is disabled—either manually by the operator; via a binary input from a customer-supplied system; or automatically by the CPC. The gas and liquid valves close and the compressor starts. Refrigerant gas is drawn out of the evaporator by the compressor, compressed, and introduced into the condenser. Most of the condensed liquid first takes the path of least resistance by flowing into the storage tank (except models CDHH and CVHH) which is vented to the high pressure economizer sump by a small bleed line. When the storage tank (except models CDHH and CVHH) is filled, liquid refrigerant must flow through the bleed line restriction. The pressure drop through the bleed line is greater than that associated with the orifice flow control device, hence liquid refrigerant flows normally from the condenser through the orifice system and into the economizer.

The free cooling option consists of the following factory-installed or supplied components:

- Additional refrigerant charge required for the free cooling cycle
- Manual free cooling controls on the unit control panel
- Refrigerant gas line with electrically actuated shutoff valve between the evaporator and condenser
- Refrigerant storage vessel adjacent to the economizer
- Liquid line with electrically activated shutoff valve between the condenser sump and evaporator

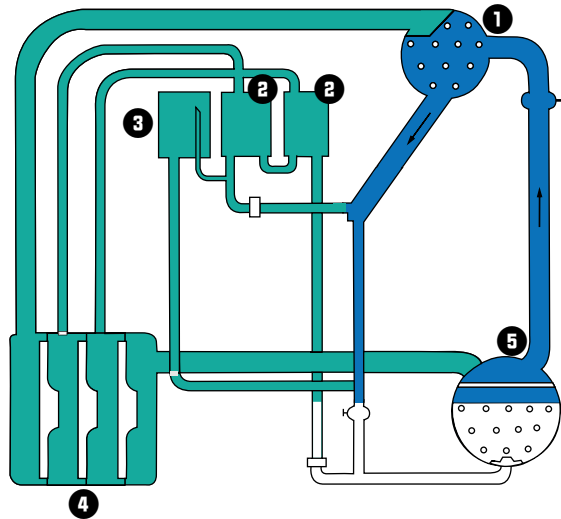


**Figure 6. CenTraVac chiller compressor operation schematic**



1. Condenser
2. Economizer
3. Refrigerant Storage Tank (except CDHH)
4. Compressor
5. Evaporator

**Figure 7. CenTraVac chiller free cooling operation schematic**



1. Condenser
2. Economizer
3. Refrigerant Storage Tank (except CDHH)
4. Compressor
5. Evaporator

For specific information on free cooling applications, contact your local Trane sales office.

# System Options

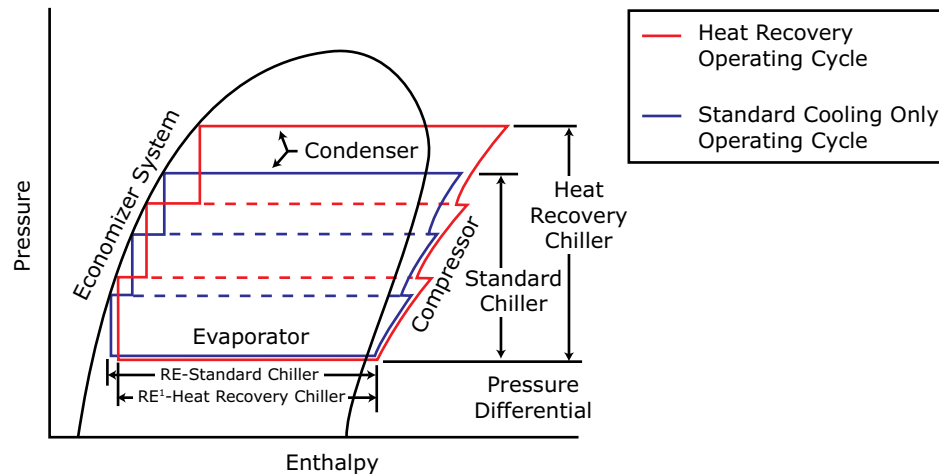
## Full Heat Recovery

A heat recovery CenTraVac™ chiller can significantly reduce energy costs by using heat which would normally be rejected to the atmosphere. This heat may be used for perimeter zone heating, reheat air conditioning systems, and preheating domestic hot water. Any building with a simultaneous heating and cooling load is a potential candidate.

Most heating applications require water warmer than the 85°F to 95°F (29.4°C to 35°C) typically sent to the cooling tower. Therefore, most heat recovery chillers are required to produce higher leaving condenser water temperatures, and thus will not achieve the energy efficiencies of standard, cooling-only chillers. The following figure illustrates the typical operating cycles of a cooling-only and a heat recovery chiller. The most noticeable differences are:

1. The pressure differential of the compressor is much greater for the heat recovery cycle.
2. The amount of heat rejected from the heat recovery condenser is greater than that which would be rejected in cooling-only operation.
3. There is a decrease in the refrigeration effect (RE). Higher condensing pressures increase the intermediate pressure in the economizer. Therefore, the liquid in the economizer has a higher enthalpy during the heat recovery mode than during standard chiller operation and the RE is slightly decreased. Because of this decreased RE, the compressor must pump more gas per ton of refrigeration.

**Figure 8. Typical operating cycles**



**Note:** RE = Refrigeration Effect

The effect of this increased pressure differential and decreased refrigeration effect is a heat recovery machine which consumes more energy during heat recovery operation.

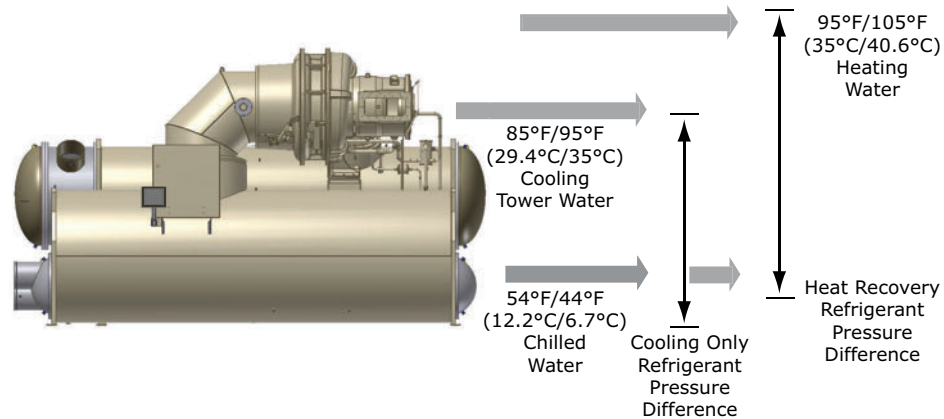
Typical catalog efficiencies for heat recovery machines operating in the heat recovery mode range from 0.64 to 0.84 kW/ton (5.49 to 4.18 COP) and range from 0.54 to 0.57 kW/ton (6.51 to 6.16 COP) for a cooling-only machine. Not only can there be an energy consumption penalty due to the inherent differences in operating cycles for heat recovery machines, but traditional chiller designs can add to that energy handicap. A heat recovery machine's operating efficiency is penalized year-round by having the capability to produce high heating water temperatures. Impellers are selected to produce the maximum refrigerant pressure difference between the evaporator and condenser, which is shown in [Figure 9, p. 27](#). This means the impeller diameters are determined by the heat recovery operating conditions.

The CenTraVac™ chiller compressor and advanced impeller design reduce this costly energy penalty. The higher lift and stability of the multi-stage compressor enables a closer match of impeller size for both the cooling only and heat recovery operating conditions.

## Simultaneous Heating and Cooling

The heat recovery CenTraVac™ chiller is an excellent choice for applications requiring simultaneous heating and cooling. These chillers save energy by recovering heat that would normally be rejected to the atmosphere and using it to provide space heating, hot water for the building, or process hot water.

**Figure 9. Refrigerant pressure difference**



This heat is provided at a fraction of conventional heating systems cost. A heat recovery CenTraVac™ chiller can provide 95°F to 105°F (35°C to 40.6°C) hot water depending upon the operating conditions. Two separate condenser shells are used with the heat recovery option for models CDHF, CVHE, and CVHF. The heating circuit and cooling tower circuit are separate, preventing cross contamination. Refrigerant gas from the compressor flows into both condense shells allowing heat rejection to one or both condenser water circuits.

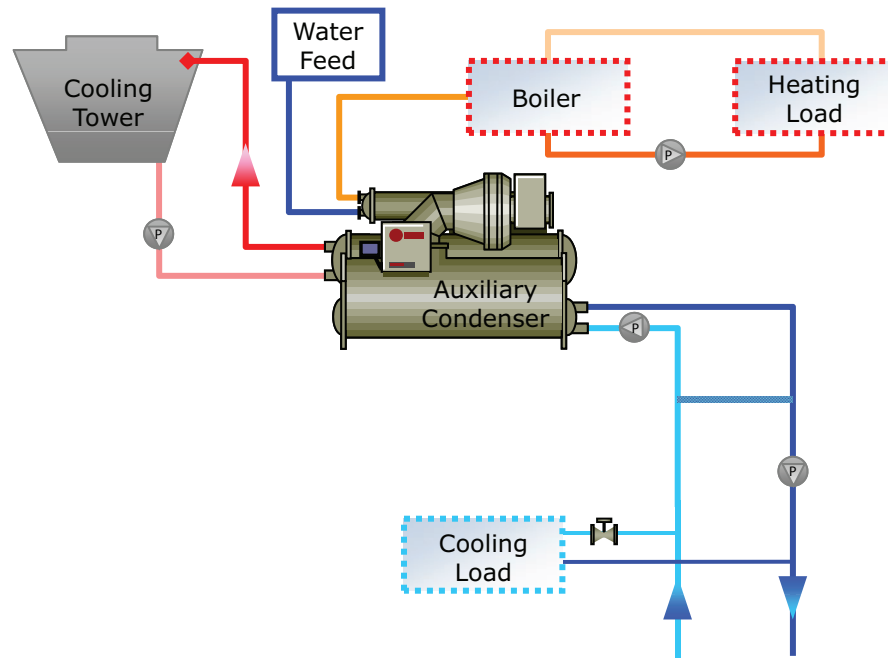
The heat recovery option for models CDHH and CVHH uses two separate bundles within the same condenser shell. Refrigerant gas from the compressor then flows into the single condenser shell allowing heat rejection to one or both condenser water circuits.

The reliability of the heat recovery CenTraVac™ chiller has been proven in installations around the world. This option is completely factory packaged.

## Partial Heat Recovery

Models CDHH, CDHF, CDHG, CVHE, CVHF, CVHG, and CVHH: All heat recovery systems require a simultaneous demand for heating and cooling. While a traditional (full) heat recovery system uses higher temperature water to satisfy a building heating load or the full heat input for domestic hot water, partial heat recovery with the auxiliary condenser option can be used for smaller heating demand, such as reheat air conditioning systems, swimming pools or to preheat domestic or boiler makeup water. Schools, hospitals, office buildings, and hotels have all proved to be excellent applications for the auxiliary condenser option.

Figure 10. Auxiliary condenser option

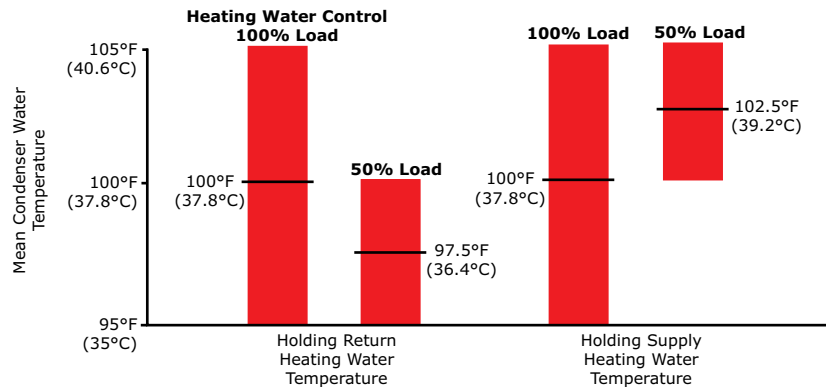


## Heating Water Temperatures and Control

To further reduce the system energy requirements, the following design considerations should be incorporated into any heat recovery system.

It is always desirable to use the lowest heating water temperature the application allows. Experience has shown that a design heating water temperature of 105°F to 110°F (40.6°C to 43.3°C) can satisfy most heating requirements. Lower temperatures increase the chiller operating efficiency in both the heating and cooling modes. In general, the heat recovery power consumption will increase 7 to 14 percent for every 10°F (5.6°C) increase in the design heating water temperature. Equally important is how that temperature is controlled. In most cases, the heating water temperature control should maintain the return heating water temperature. By allowing the supply water temperature to float, the mean water temperature in the system drops as the chiller load decreases and less heat is rejected to the condenser. As the mean heating water temperature drops, so does the refrigerant condensing temperature and pressure difference which the compressor is required to produce at part load. This increases the unloading range of the compressor.

When the supply heating water temperature to the building system is maintained and the return heating water temperature to the condenser is allowed to float, the mean heating water temperature actually rises as the chiller load decreases and less heat is rejected to the condenser. As the following figure illustrates, when the compressor unloads, the pressure difference that it must oppose to prevent surging remains essentially the same, while the compressor's ability to handle the pressure difference decreases. Therefore, the chiller's ability to unload without the use of hot gas bypass is reduced.

**Figure 11. Heating water control**


Hot gas bypass artificially increases the load on the compressor by diverting refrigerant gas from the condenser back to the compressor. Although hot gas bypass increases the unit's power consumption by forcing the compressor to pump more refrigerant gas, it will increase the heat available to recover for those applications where significant heating loads remain as the cooling load decreases.

## Application

All heat recovery systems require a simultaneous demand for heating and cooling. While a traditional (full) heat recovery system uses higher temperature water to satisfy a building heating load or the full heat input for domestic hot water, partial heat recovery with the auxiliary condenser option can be used for smaller heating demand, such as reheat air conditioning systems, swimming pools or to preheat domestic or boiler makeup water. Schools, hospitals, office buildings, and hotels have all proved to be excellent applications for the auxiliary condenser option.

## Increased Chiller Efficiency

The auxiliary condenser not only captures energy otherwise lost, it also increases chiller efficiency by increasing condenser heat transfer surface area and lowering the pressure differential the compressor must generate. This is because the auxiliary condenser water is always at a lower temperature than the standard condenser water.

Auxiliary condensers are available in standard and large. Because the auxiliary condenser is a separate condenser, there is no cross contamination between the cooling tower water and the heat recovery water circuits. No temperature controls are required and auxiliary condensers come factory-mounted.

## Controls

The auxiliary condenser was designed for simplicity of operation. Machine load, water flow rate, and temperature determine the amount of heat recovered. There are no controls needed for heating water temperature because no attempt is made to maintain a specific hot water temperature in or out of the auxiliary condenser.

## Operation

The auxiliary condenser is a factory-mounted, separate, shell and tube heat exchanger available on models CDHF, CDHG, CVHE, CVHF, CVHG, and CVHH GenTraVac™ chillers.

Because refrigerant gas always migrates to the area of lowest temperature, auxiliary condenser operation is simple. As the discharge gas leaves the compressor, it is free to flow to the auxiliary condenser or the standard condenser. Since water entering the auxiliary condenser is normally colder than that entering the standard condenser, the auxiliary condenser will have a lower bundle temperature and will attract the refrigerant gas. The auxiliary condenser will recover as much heat as the machine cooling load, heating water temperature, and flow rate will allow. All remaining heat will automatically be rejected through the standard condenser to the atmosphere through the cooling tower. No controls are needed to balance heat rejection in the two condensers.

Good system design will include a heated water bypass to ensure that water does not circulate through the auxiliary condenser when the chiller is de-energized. There are several ways to bypass the auxiliary

condenser. When the hot water system is installed as shown, the bypass is automatic if the heating water pump is interlocked with the chiller compressor motor.

Another bypass arrangement is to install a diverting valve. When interlocked with the compressor motor, this valve diverts the heating water flow to the conventional heating system whenever the chiller is not operating. These are only examples of the many ways available to accomplish a bypass.

Contact your local Trane sales office for further specific information.

**Table 5. Auxiliary condenser flow limits and connection sizes**

Auxiliary Condenser Bundle Size	Two Pass				Connection Size (in.)
	Internally Enhanced IECU		Low Fouling TLCU		
	Minimum (gpm)	Maximum (gpm)	Minimum (gpm)	Maximum (gpm)	
Standard (80)	74	276	69	194	5
Large (130)	121	453	112	318	5

## Thermal/Ice Storage

An ice storage system uses a dual-duty chiller to make ice at night when utilities charge less for electricity. The ice supplements or even replaces mechanical cooling during the day when utility rates are at their highest. This reduced need for cooling results in significant utility cost savings.

Another advantage of ice storage is standby cooling capacity. If the chiller is unable to operate, one or two days of ice may still be available to provide cooling. In that time, the chiller can be repaired before building occupants feel any loss of comfort.

The CenTraVac™ chiller is uniquely suited for low temperature applications, like ice storage, because it uses multiple stages of compression, versus competitive designs with only one stage. This allows the chiller to produce ice efficiently with less stress on the machine. The multi-stage compressor allows the lower suction temperatures required to produce ice and the higher chiller efficiencies attributed to centrifugal chillers. Trane® three-stage and two-stage centrifugal chillers produce ice by supplying ice storage vessels with a constant supply of 20°F to 25°F (-6.7°C to -3.9°C) glycol solution. CenTraVac™ chillers selected for these lower leaving fluid temperatures are also selected for efficient production of chilled fluid at normal comfort cooling conditions. The ability of Trane® chillers to serve “double duty” in ice production and comfort cooling greatly reduces the capital cost of ice storage systems.

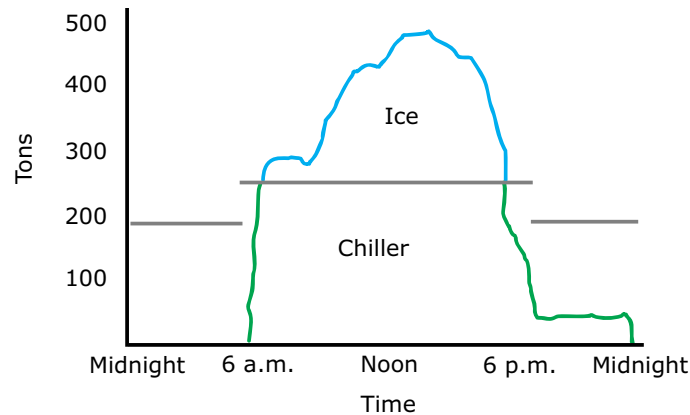
A glycol solution is used to transfer heat from the ice storage tanks to the CenTraVac™ chiller and from the cooling coils to either the chiller or the ice storage tanks. The use of a freeze-protected solution eliminates the design time, field construction cost, large refrigerant charges, and leaks associated with ice plants. Ice is produced by circulating 20°F to 25°F (-6.7°C to -3.9°C) glycol solution through modular insulated ice storage tanks. Each tank contains a heat exchanger constructed of polyethylene tubing. Water in each tank is completely frozen with no need for agitation. The problems of ice bridging and air pumps are eliminated.

When cooling is required, ice chilled glycol solution is pumped from the ice storage tanks directly to the cooling coils. No expensive heat exchanger is required. The glycol loop is a sealed system, eliminating expensive annual chemical treatment costs. The centrifugal chiller is also available for comfort cooling duty at nominal cooling conditions and efficiencies. The modular concept of glycol ice storage systems and the proven simplicity of Trane Tracer® controls allow the successful blend of reliability and energy saving performance in any ice storage application.

The ice storage system operates in six different modes, each optimized for the utility cost of the hour:

1. Off
2. Freeze ice storage
3. Provide comfort cooling with ice
4. Provide comfort cooling with chiller
5. Provide comfort cooling with ice and chiller
6. Freeze ice storage when comfort cooling is required

**Figure 12. Ice storage demand cost savings**



Simple and smart control strategies are another advantage the CenTraVac™ chiller has for ice storage applications. Trane Tracer® building management systems can actually anticipate how much ice needs to be made at night and operate the system accordingly. The controls are integrated right into the chiller. Two wires and preprogrammed software dramatically reduce field installation cost and complex programming.

Tracer® optimization software controls operation of the required equipment and accessories to easily transition from one mode of operation to another. Even with ice storage systems, there are numerous hours when ice is neither produced or consumed, but saved. In this mode, the chiller is the sole source of cooling. To cool the building after all ice is produced, but before high electrical demand charges take effect, Tracer® controls set the CenTraVac™ chiller leaving fluid setpoint to the system's most efficient setting and start the chiller.

When electrical demand is high, the ice pump is started and the chiller is either demand-limited or shutdown completely. Tracer controls have the intelligence to optimally balance the contribution of ice and chiller in meeting the cooling load.

The capacity of the chiller plant is extended by operating the chiller and ice in tandem. Tracer controls ration the ice, augmenting chiller capacity while reducing cooling costs.

When ice is produced, Tracer® controls will lower the CenTraVac™ chiller leaving fluid setpoint and start the chiller, ice pumps, and other accessories. Any incidental loads that persist while producing ice can be addressed by starting the load pump and drawing spent cooling fluid from the ice storage tanks.

For specific information on ice storage applications, contact your local Trane sales account manager.



# Application and Job Site Considerations

## Condenser Water Control

CenTraVac™ chillers start and operate over a wide range of load conditions with controlled water temperatures. Reducing the condenser water temperature is an effective way to lower the chiller power input; however, the effect of lowering the condenser water temperature may cause an increase in system power consumption. Although CenTraVac™ chillers can start and operate without control of the condenser water temperature, However, for optimum system power consumption, and for multiple-chiller applications, control of the condenser water circuit is recommended. Integrated control of the chillers, pumps, and towers is easily accomplished with the chiller controller and/or Tracer® building controls.

Most chillers are designed for entering tower temperatures around 85°F (29.5°C), but CenTraVac™ chillers can operate at reduced lift down to a 3 psid (20.7 kPaD) pressure differential between the condenser and evaporator at any steady state load without oil loss, oil return, motor cooling, refrigerant hang-up, or purge problems. This can equate to safe minimum entering condenser water temperatures at or below 55°F (12.8°C) dependent on a variety of factors such as load, leaving evaporator temperature, and component combinations. Start-up below this differential is possible as long as the 3 psid (20.7 kPaD) minimum pressure differential is achieved within a given amount of time. Refer to *CenTraVac™ Water-cooled Chillers Models CDHF, CDHG, CVHE, CVHF, CVHG Condenser Water Temperature Control Engineering Bulletin* (CTV-PRB027\*-EN) for additional information.

## Water Treatment

The use of untreated or improperly treated water in a chiller may result in scaling, erosion, corrosion, algae, or slime. It is recommended that the services of a qualified water treatment specialist be used to determine what treatment, if any, is advisable. Trane assumes no responsibility for the results of untreated, or improperly treated water.

## Water Pumps

Avoid specifying or using 60 Hz (3600 rpm) or 50 Hz (3000 rpm) condenser and chilled-water pumps. Such pumps may operate with objectionable noises and vibrations. In addition, a low frequency beat may occur due to the slight difference in operating rpm between water pumps and CenTraVac™ chiller motors. Where noise and vibration-free operation are important, Trane encourages the use of 60 Hz (1750 rpm) or 50 Hz (1500 rpm) pumps.

## Water Flow

Today's technology challenges AHRI's traditional design of 3 gpm/ton (0.054 L/s·kW) through the condenser. Reduced condenser flows are a simple and effective way to reduce both first and operating costs for the entire chiller plant. This design strategy will require more effort from the chiller. But pump and tower savings will typically offset any penalty. This is especially true when the plant is partially loaded or condenser relief is available.

In new systems, the benefits can include dramatic savings associated with:

- Size and cost of the water pumps and cooling tower
- Pump and cooling tower fan energy (30 to 35 percent reduction)
- Size and cost for condenser lines and valves

Replacement chiller plants can reap even greater benefits from low flow condensers. Because the water lines and tower are already in place, reduced flows offer tremendous energy savings. Theoretically, a 2 gpm/ton (0.036 L/s·kW) design applied to a 3 gpm/ton (0.054 L/s·kW) system would offer a 70 percent reduction in pump energy. At the same time, the original tower would require a nozzle change but would then be able to produce about two degrees colder condenser water than before. These two benefits would typically offset any extra effort required by the chiller.

Contact your local Trane account manager for information regarding optimum condenser water temperatures and flow rates for a specific application.



## Shipment and Assembly

Each CenTraVac™ chiller ships as a factory assembled, factory tested package, fully charged, ready to rig into place on factory-supplied isolation pads. A full oil charge is shipped in the oil sump and a 5 psig (34.5 kPaG) (for CDHF, CDHG, CVHE, CVHF, and CVHG) and 3 to 5 psig (20.7 to 34.5 kPaG) (for CDHH and CVHH) dry nitrogen charge prevents condensation and confirms a leak-free seal before installation.

**Figure 13. Shrink-wrapped chiller, ready to ship from the factory**



**Figure 14. Unit control panel**



Each CenTraVac™ chiller is shrink-wrapped to help ensure that it is delivered to the customer in the same condition it left the factory. The packaging process used is industry-leading; each unit is covered with a six-sided 10 mil, military-grade recyclable film.



# Controls

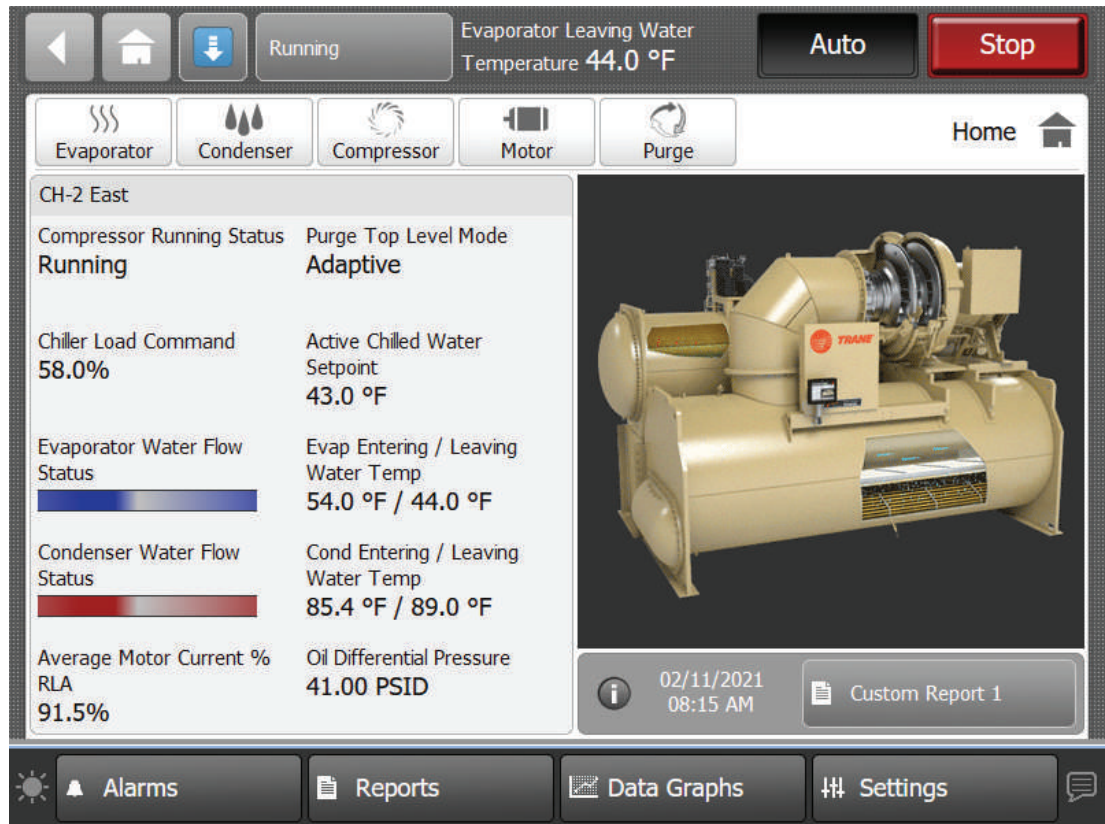
## Tracer Symbio 800 Controller

CenTraVac™ chillers leverage a Tracer® Symbio™ 800 controller, which uses Feed Forward Adaptive Control™ strategies to anticipate and compensate for changes in the chiller's operating conditions. Key features and benefits of the Tracer Symbio 800 chiller control are highlighted here with additional information available in *CenTraVac™ Water-cooled Chillers Models CDHF, CDHG, CVHE, CVHF, CVHG Condenser Water Temperature Control Engineering Bulletin (CTV-PRB027\*-EN)*.

### Control Panel and Operator Interface

The Tracer® AdaptiView™ display is a 12 inch (30.5 centimeter) touchscreen display that provides an intuitive navigation system. This display allows the user to select from 27 different languages to ensure that the operator can easily see and understand how the chiller is operating.

**Figure 15. Tracer AdaptiView display**



- Data graphs
- Mode overrides
- Status (all subsystems)
- Auto/Stop commands
- Diagnostics
- ASHRAE report
- Setpoint adjustment (daily user points)
- LLID Binding

## Feed Forward Adaptive Control

Feed Forward Adaptive Control™ is an open loop, predictive control strategy that uses the evaporator entering water temperature as an indicator of load change, allowing the controller to respond faster and to maintain stable leaving water temperatures. Feed Forward Adaptive Control™ algorithms are patented control strategies that respond to both normal and extreme operating conditions to maintain effective chiller plant operation.

## Variable-Primary Flow (VPF)

Chilled-water systems that vary the water flow through the chiller evaporator have caught the attention of engineers, contractors, building owners, and operators. Varying the water flow reduces the energy consumed by pumps, while having limited effect on the chiller energy consumption. This strategy can be a significant source of energy savings, depending on the application. As standard, the CenTraVac™ chiller can handle up to 30 percent change in flow per minute and stay online. Add the “[Optional Enhanced Flow Management Package](#),” p. 36 for even greater capacity control and the ability to display the evaporator and condenser flow rates on the control panel.

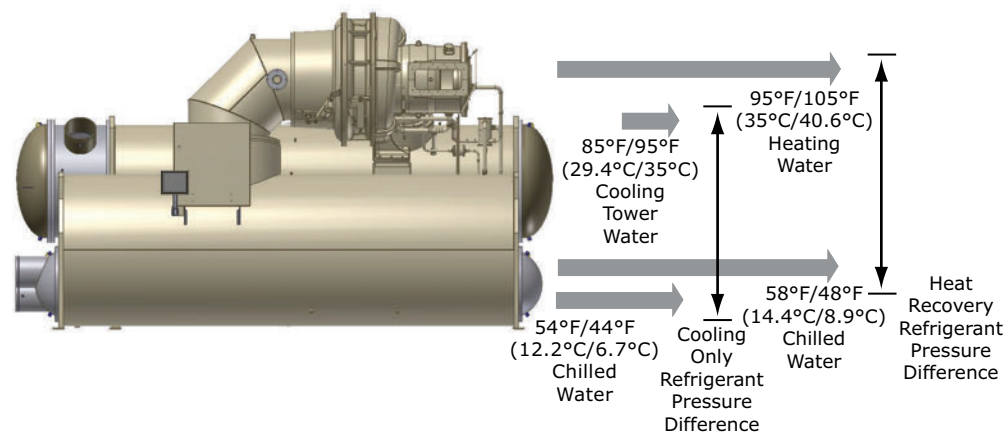
## 34°F (1.1°C) Leaving Water Temperature

Another benefit of Feed Forward Adaptive Control™ is the ability to operate the CenTraVac™ chiller at low leaving evaporator water temperatures without the use of glycol. Colder water is generally used in wide delta-T systems, reducing the pumping energy required and making it less expensive to deliver cooling capacity over long distances. For this reason, low leaving water temperatures are frequently used in district cooling applications, but can also be used in comfort cooling applications. Your local Trane account manager can assist in making chiller two- or three-pass selections using 34°F to 36°F (1.1°C to 2.2°C) leaving water temperatures. Special installation procedures may be required.

## Chilled-Water Reset

Chilled-water reset reduces chiller energy consumption during periods of the year when heating loads are high and cooling loads are reduced. It is based on return chilled-water temperature. Resetting the chilled-water temperature reduces the amount of work that the compressor must do by increasing the evaporator refrigerant pressure. This increased evaporator pressure reduces the pressure differential the compressor must generate while in the heat recovery mode. Chilled-water reset is also used in combination with the hot-water control. By resetting the chilled-water temperature upward, the compressor can generate a higher condenser pressure, resulting in higher leaving hot-water temperatures.

**Figure 16. Chilled-water reset**



## Hot-Water Control

In the hot-water mode, the chiller produces hot water as its primary objective, rather than chilled water—similar to the heat recovery operation. A leaving condenser water set point is maintained while the leaving evaporator temperature is allowed to modulate with the load. The hot-water mode is performed



without a secondary condenser. As an option, the “[Optional Extended Operation Package](#),” p. 38 allows an external controller to enable, disable, and modulate this mode.

## Ice-Building Control

For chillers that have been selected for ice-building operation, the standard control package includes the ice-building mode. As an option, the “[Optional Extended Operation Package](#),” p. 38 allows an external controller to enable, disable, and modulate this mode.

## Optional Enhanced Flow Management Package

With the Enhanced Flow Management Package, the Tracer® Symbio™ 800 chiller controller reliably accommodates variable evaporator water flow and virtually eliminates its effect on the chilled water temperature. This option includes transducers for the differential evaporator and condenser water pressures. Flow switches or some other means to prove flow are still required and must be field connected. One type of sensor handles all pressure ranges up to 300 psig (2068.4 kPaG).

The Tracer Symbio 800 chiller controller uses a patented, variable water-flow compensation algorithm to maintain stable, precise capacity control. If the water-pressure transducer fails and the flow switch continues to prove flow, water-flow compensation will be disabled and the design delta-T will be used. For applications designed to operate with variable-primary water flow, variable-flow compensation allows the chiller to respond quickly to changes in chilled-water flow rate. By automatically adjusting the control gain, large changes in the water-flow rate are accommodated. [Figure 17, p. 37](#) demonstrates water-temperature control without flow compensation. In contrast, [Figure 18, p. 37](#) demonstrates water-temperature control with flow compensation enabled. The chilled-water temperature remains stable, even when the water flow rate drops 50 percent in 30 seconds.

Another benefit is disturbance rejection. [Figure 19, p. 38](#) shows the test results from step changes in water flow with increasing magnitudes. The leaving chilled-water temperature remains largely unaffected. Even the most severe change—dropping water flow 66 percent in 30 seconds—caused only a small, 1.5°F (0.83°C) variation in chilled-water temperature. While it is unlikely that a chiller application would make water flow changes of this magnitude, the results demonstrate that the chiller is more than capable of supporting variable water flow applications.

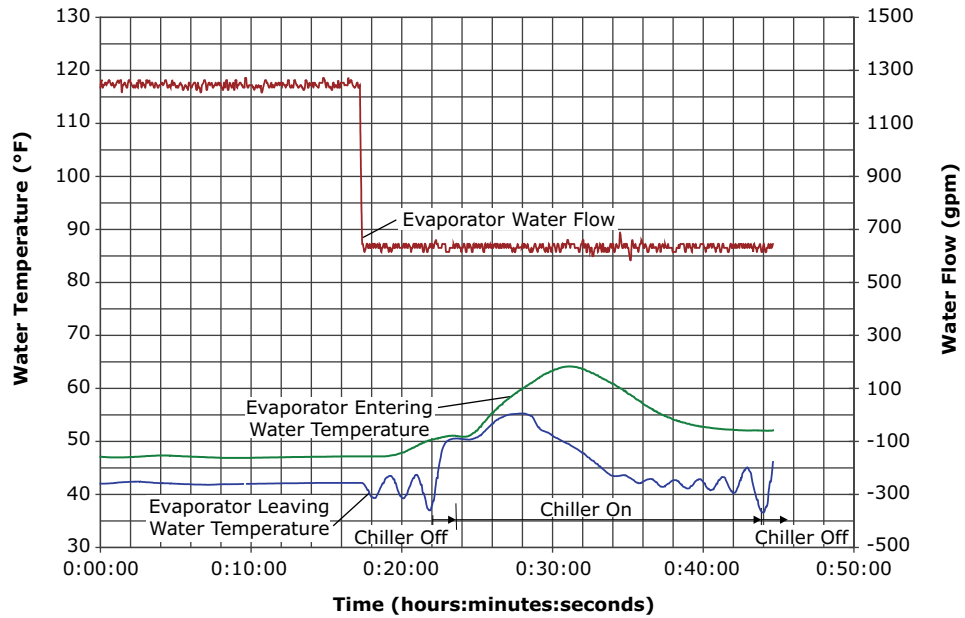
The following data will be shown on the Tracer AdaptiView display, the Tracer TU display, and at the Tracer controls:

- Evaporator capacity (tons, kW)
- Evaporator and condenser flow rates (gpm, L/s)
- Evaporator and condenser differential water pressures (psid, kPaD)

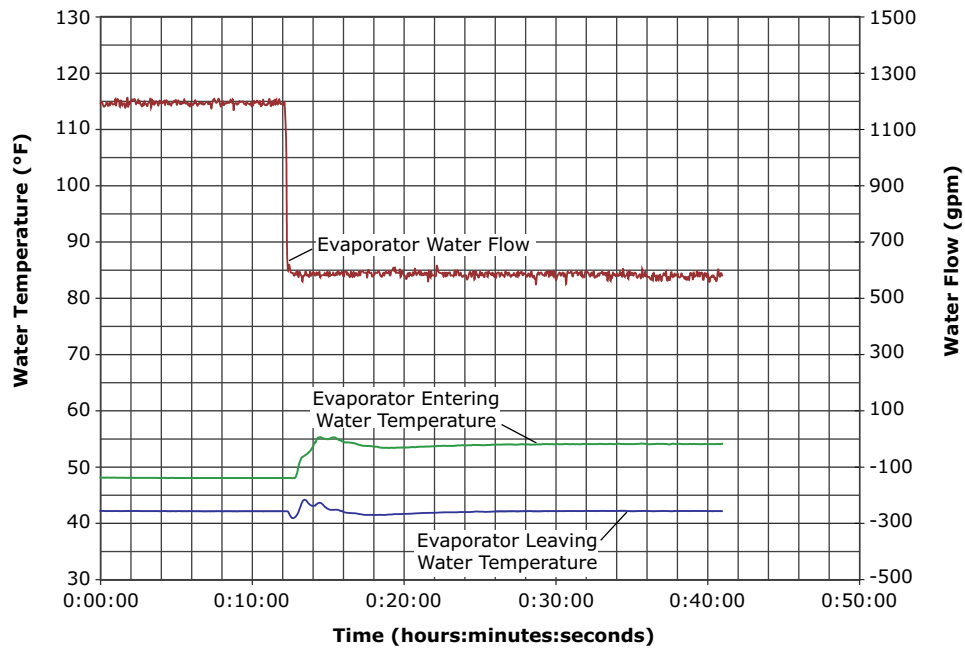
It will automatically adjust capacity control to:

- Minimize variable-flow disturbance
- Maintain control stability at low flow

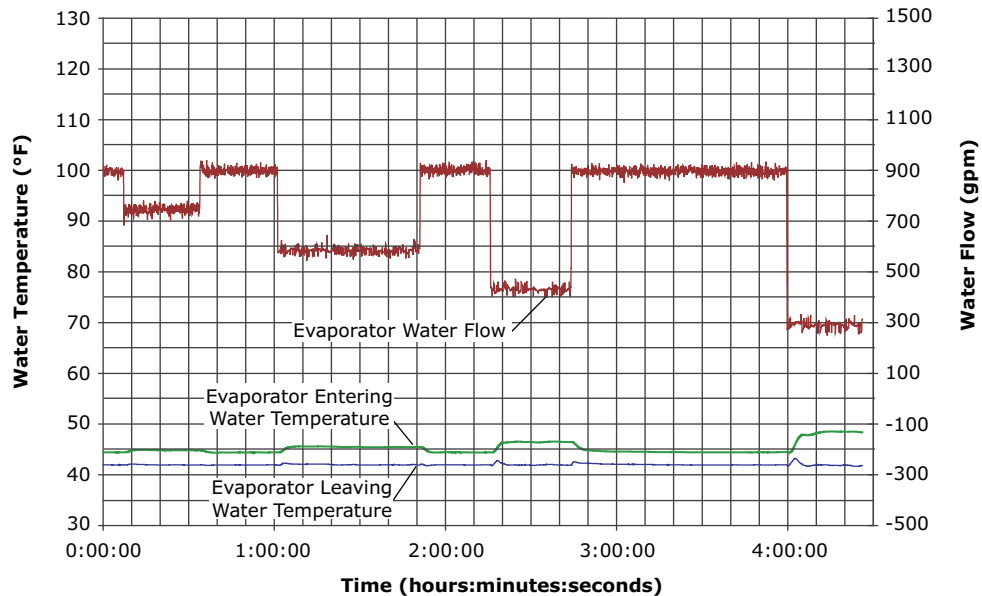
**Figure 17. Capacity control without enhanced flow management package**



**Figure 18. Capacity control with enhanced flow management package**



**Figure 19. Capacity control with flow changes and enhanced flow management package**



## Optional Extended Operation Package

Select the extended-operation package for chillers that require external ice-building control, hot water control, and/or base-loading capabilities. This option includes the following: refrigerant monitor input, external base-loading binary input, external base-loading control, external ice-building binary input, external ice-building control and external hot-water control binary input.

**Base-Loading Control**—This option allows an external controller to directly modulate the capacity of the chiller. It is typically used in applications where virtually infinite sources of evaporator load and condenser capacity are available and it is desirable to control the loading of the chiller. Two examples are industrial process applications and cogeneration plants.

**Ice-Building Control**—This option allows an external controller to control the chiller in an ice storage system. While the standard controller is fully capable of running the chiller in ice-building mode, installation savings and additional energy savings can be realized by using the Chiller Plant Control module of the Tracer building automation system. Chiller Plant Control anticipates how much ice needs to be made at night and operates the system accordingly. The controls are integrated with the chiller—two wires and pre-programmed software reduce field-installation cost and complex custom programming.

**Hot-Water Control**—This option allows an external controller to enable/disable and modulate the hot-water control mode. Occasionally, CenTraVac™ chillers are used to provide heating as a primary operation. In this case the external controller or operator would select a hot-water temperature set point and the chiller capacity would be modulated to maintain the set point. Heating is the primary function and cooling is a waste product or a secondary function. This technique provides application flexibility, especially in multiple-chiller plants in conjunction with undersized heating plants.

**Refrigerant Monitor**—This option allows for a refrigerant monitor to send a 4–20 mA signal to the Tracer® Symbio™ 800 control. It can be calibrated to correspond to either 0–100 ppm or 0–1000 ppm concentration levels. The concentration level is displayed on the Tracer AdaptiView display and Tracer TU, but the chiller will not take any action based on the input from the refrigerant monitor.

Alternatively, the BACnet® module allows the refrigerant monitor to be connected to Trane Tracer controls, which have the ability to increase ventilation in the equipment room in response to high refrigerant concentrations.

---

## Communication Interface

### LonTalk Building Automation Systems

The LonTalk® communication protocol for the Symbio™ 800 controller expands communications from the unit UCM network to a Tracer® Ensemble™ or Tracer SC+ building automation system or third party building automation system. Utilizing LonTalk, the BAS allows external setpoint and configuration adjustment and monitoring of status and diagnostics. The Symbio 800 utilizes an FTT-10A free topology transceiver, which supports non-polarity sensitive, free topology wiring—which in turn allows the system installer to utilize star, bus, and loop architectures. This controller works in standalone mode, peer-to-peer with one or more other units, or when connected to a Tracer Ensemble, Tracer SC+, or a third party building automation system that supports LonTalk.

### BACnet Building Automation Control Network

The BACnet® control network for Symbio™ 800 expands communications from the unit UCM network to the Tracer® Ensemble™ or Tracer SC+ building automation system or third party building automation system. Utilizing BACnet, the BAS allows external setpoint and configuration adjustment and monitoring of status and diagnostics. The Symbio™ 800 utilizes the BACnet defined TP protocol as defined in ASHRAE standard 135-2004. This controller works in standalone mode, with Tracer® Ensemble™, Tracer SC+ or when connected to a third party building automation system that supports BACnet.

### Modbus Automation Control Network

Allows the user to easily interface with Modbus™ RTU Communication protocol via a single twisted pair wiring from the Symbio™ 800 controller to a factory installed device.

### Tracer TU Interface

The Tracer chiller controller adds a level of sophistication better served by a PC application to improve service technician effectiveness and minimize chiller downtime. The Tracer AdaptiView™ display is intended to serve only typical daily tasks. The portable PC-based service-tool software, Tracer TU, supports service and maintenance tasks.

Tracer TU serves as a common interface to all Symbio 800 and BCI-C (BACnet®) based Trane chillers, and will customize itself based on the properties of the chiller with which it is communicating. Thus, the service technician learns only one service interface.

The panel bus is easy to troubleshoot using LED sensor verification. Only the defective device is replaced. Tracer TU can communicate with individual devices or groups of devices.

All chiller status, machine configuration settings, customizable limits, and up to 100 active or historic diagnostics are displayed through the service-tool software interface.

LEDs and their respective Tracer TU indicators visually confirm the availability of each connected sensor, relay, and actuator.

Tracer TU is designed to run on a customer's laptop, connected to the Tracer Symbio 800 control panel with a USB cable.

Contact your local Trane account manager for more information.

## Building Automation and Chiller Plant Control

### System and Chiller Plant Controls

Tracer® SC+ allows you to streamline facility management without reinventing the entire system. Adding Tracer® SC+ to your system provides a flexible, cost effective solution for building automation and climate control that can extend to lighting and energy consumption. Accessible from a personal computer, tablet or smart phone, Tracer® SC+ eliminates the need for a dedicated computer so you can manage system performance whenever and wherever it is convenient. Tracer® SC+ is a simplified, web-based management tool that reduces scheduling, reporting and system application chores to simple “point and click” tasks. Tracer® SC+ strikes the perfect balance between tenant comfort and energy efficiency, resulting in operating cost savings and a better bottom line.



## Area Application

The Area application coordinates groups of equipment based on tenant or occupant organization within a building, allowing for standard calculations and functions. The Area application can be configured to use multiple algorithms, along with area temperatures and humidity inputs, to make an economizing decision. Users are presented with a simplified, logical user interface with logical areas rather than directly interfacing with equipment. The Area application also supports:

- Optimal start/stop
- Humidity pulldown
- Night purge
- Unoccupied heating/cooling setpoints
- Unoccupied humidify/dehumidify
- Timed override functions

## Chiller Plant Control (CPC)

The Chiller Plant Control (CPC) application permits users to configure a chiller plant for optimal efficiency and reliability, while providing a means for monitoring and controlling the daily operation. Depending upon the chiller plant configuration and design, the CPC application can do the following:

- Provide overall chiller plant status information and alarms to local and remote Tracer® SC+ users
- Enable or disable chiller plants
- Start, stop, and monitor the status of system chilled water pumps
- Calculate individual chilled water setpoints for chillers in series chiller plants
- Request when chillers are added or subtracted according to building load requirements and user-specified add and subtract logic
- Rotate chillers according to user-defined intervals
- Remove chillers from the rotation in the event

For more information, refer to BAS-APG012\*-EN (*Applications Guide: Tracer SC System Controller Chiller Plant Control Application*).

## Chiller-Tower Optimization

The Tracer® chiller-tower optimization extends Adaptive Control™ to the rest of the chiller plant. Chiller-tower optimization is a unique control algorithm for managing the chiller and cooling tower subsystem. It considers the chiller load and real-time ambient conditions, then optimizes the tower setpoint temperature to maximize the efficiency of the entire subsystem. This real-time optimization may vary tower temperatures between 50°F–90°F (10°C–32.2°C) depending upon current outdoor conditions, chiller loading, and ancillary efficiencies.

## Tracer Building Controls

The Tracer Symbio 800 chiller controller is designed to communicate with a wide range of building automation systems. To leverage all of your chiller capabilities, integrate your chiller into a Tracer SC+ system controller or a comprehensive Tracer ES building management system.

The Tracer® SC+ system controller can manage multiple systems within a building. It provides a flexible solution for managing your building's HVAC system, with an intuitive, web-based user interface and industry-leading 3D graphics and pre-programmed features such as:

- **Chiller plant management**—Allows you to manage multiple chillers of any size and coordinate with other equipment as part of your chiller plant operation for even greater energy efficiency and reduced operating costs.
- **High performance chilled water systems**—Apply integrated pre-packaged design concepts that are optimized for energy and environmental performance; sustainable systems that deliver measurable, repeatable and superior performance with lower operating costs.

The Tracer ES building management software provides a web-based, scalable, integration platform for managing all of your facilities as a single enterprise. It allows you to view status and manage alarms and schedules from one system—from anywhere, and its reports enable enterprise-wide decision making for optimized performance. It also offers easy integration with other systems via BACnet® IP.



## Standard Protections

The Tracer® Symbio™ 800 controller uses proportional-integral-derivative (PID) control for all limits—there is no dead band. This removes oscillation above and below setpoints and extends the capabilities of the chiller. Some of the standard protection features of the chiller controller are described in this section.

For a complete listing of CenTraVac™ motor protection capabilities, refer to *Frequency Drives, Starters, and Electrical Components for CenTraVac Chillers Engineering Bulletin* (CTV-PRB004\*-EN). For a complete listing of the chiller protection capabilities, refer to *Diagnostic Descriptions, Troubleshooting Tables, and Control Component Overview for Water-cooled CenTraVac Chillers with Symbio™ Control Diagnostics Manual* (CTV-SVD005\*-EN). Contact your local Trane sales office with any questions or for more information.

### High Condenser-Pressure Protection

The chiller will protect itself from a starter failure that prevents disconnecting the compressor motor from the incoming line power.

The chiller controller's condenser limit keeps the condenser pressure under a specified maximum pressure. The chiller will run up to 100 percent of this setpoint before the Adaptive Control™ mode reduces capacity.

### Starter-Contactor Failure Protection

The chiller will protect itself from a starter failure that prevents the compressor motor from disconnecting from the line to the limits of its capabilities.

The controller starts and stops the chiller through the starter. If the starter malfunctions and does not disconnect the compressor motor from the line when requested, the controller will recognize the fault and attempt to protect the chiller by operating the evaporator and condenser water pumps, oil/refrigerant pumps and attempting to unload the compressor.

### Loss of Water-Flow Protection

Tracer® Symbio™ 800 control has an input that will accept a contact closure from a proof-of-flow device such as a flow switch or pressure switch. Customer wiring diagrams also suggest that the flow switch be wired in series with the cooling-water and condenser-water pump starter auxiliary contacts. When this input does not prove flow within a fixed time during the transition from Stop to Auto modes of the chiller, or if the flow is lost while the chiller is in the Auto mode of operation, the chiller will be inhibited from running by a diagnostic.

### Evaporator Limit Protection

Evaporator Limit is a control algorithm that prevents the chiller from tripping on its low refrigerant-temperature cutout. The machine may run down to the limit but not trip. Under these conditions the intended chilled-water setpoint may not be met, but the chiller will do as much as it can. The chiller will deliver as much cold water as possible even under adverse conditions.

### Low Evaporator-Water Temperature

Low evaporator-water temperature protection, also known as Freeze Stat protection, avoids water freezing in the evaporator by immediately shutting down the chiller and attempting to operate the chilled-water pump. This protection works together with the Evaporator Limit protection, and prevents freezing in the event of extreme errors in the evaporator-refrigerant temperature sensor.

The cutout setting should be based on the percentage of antifreeze used in the customer's water loop. The chiller's operation and maintenance documentation provides the necessary information for percent antifreeze and suggests leaving-water temperature-cutout settings for a given chilled-water temperature setpoint.

### High Vacuum-Lockout Protection

The controller inhibits a compressor start with a latching diagnostic whenever the evaporator pressure is less than or equal to 3.1 psia (21.4 kPaA). This protects the motor by locking out chiller operation while the unit is in a high vacuum preventing start-up without a refrigerant change during commissioning.

## Oil-Temperature Protection

Low oil-temperature trips when the oil pump and/or compressor are running may be an indication of refrigerant diluting the oil. If the oil temperature is at or below the low oil-temperature setpoint, the compressor is shutdown on a latching diagnostic and cannot be started. The diagnostic is reported at the user interface. The oil heater is energized in an attempt to raise the oil temperature above the low oil-temperature setpoint.

High oil-temperature protection is used to avoid overheating the oil and the bearings.

## Low Differential Oil-Pressure Protection

Oil pressure is indicative of oil flow and active oil-pump operation. A significant drop in oil pressure indicates a failure of the oil pump, oil leakage, or a blockage in the oil circuit.

During compressor prelube the differential pressure should not fall below 12 psid (82.7 kPaD). A shutdown diagnostic will occur within 2 seconds of the differential pressure falling below two-thirds (CDHF, CDHG, CVHE, CVHF, and CVHG) or three-quarters (CDHH and CVHH) of the low differential oil-pressure cutout.

When the compressor is running the shutdown diagnostic will occur when the differential pressure falls below the differential oil-pressure cutout for more than (cutout x 3) seconds. This allows for a relatively high cutout to be violated longer before triggering shutdown, as compared to a low cutout.

## Excessive Purge Detection

Pump-out activity indicates the amount of air leaking into the chiller refrigerant system. The operator is informed when the air-leakage rate changes. The operator can specify an expected leakage rate, and can be notified through a diagnostic if the rate is higher than expected.

Occasionally, when a service technician performs a mechanical repair on the chiller, an unusually high pump-out rate is expected for a certain period of time following the procedure. The service excessive pump-out override allows the technician to specify a time period for the purge system to rid the chiller of air in the system. This temporarily suspends excessive purge detection.

## Phase-Unbalance Protection

Phase-unbalance protection is based on an average of the three-phase current inputs. The ultimate phase-unbalance trip point is 30 percent. In addition, the RLA of the motor is derated by resetting the active current limit setpoint based on the current unbalance. The RLA derate protection can be disabled in the field start-up menu.

The following derates apply when the phase-unbalance limit is enabled.

For CDHF, CDHG, CVHE, CVHF, and CVHG:

10% unbalance = 100% RLA available  
15% unbalance = 90% RLA available  
20% unbalance = 85% RLA available  
25% unbalance = 80% RLA available  
30% unbalance = Shutdown

For CDHH and CVHH:

Less than 20% unbalance = 100% RLA available  
20% unbalance = 80% RLA available  
25% unbalance = 86% RLA available  
30% unbalance = Shutdown

## Phase-Loss Protection

The controller will shutdown the chiller if any of the three-phase currents feeding the motor drop below 10 percent RLA. The shutdown will result in a latching phase-loss diagnostic. The time to trip is 1 second at minimum, 3 seconds maximum.

## Phase Reversal/Rotation Protection

The controller detects reverse-phase rotation and provides a latching diagnostic when it is detected. The time to trip is 0.7 seconds.

## Momentary Power Loss and Distribution Fault Protection

Three-phase momentary power loss (MPL) detection gives the chiller improved performance through many different power anomalies. MPLs of 2.5 cycles or longer will be detected and cause the unit to shutdown. The unit will be disconnected from the line within 6 line cycles of detection. If enabled, MPL protection will be active any time the compressor is running. MPL is not active on reduced-voltage starters during start-up to avoid nuisance trips. The MPL diagnostic is an automatic reset diagnostic.

An MPL has occurred when the motor no longer consumes power. An MPL may be caused by any drop or sag in the voltage that results in a change in the direction of power flow. Different operating conditions, motor loads, motor size, inlet guide vane position, etc., may result in different levels at which this may occur. It is difficult to define an exact voltage sag or voltage level at which a particular motor will no longer consume power, but we are able to make some general statements concerning MPL protection:

The chiller will remain running under the following conditions:

- Second-order or lower harmonic content on the line
- Control-voltage sags of any magnitude less than 3 line cycles
- Control-voltage sags of 40 percent or less for any amount of time
- Line-voltage sag of 1.5 line cycles or less for any voltage magnitude sag

The chiller may shutdown under the following conditions:

- Line-voltage sags of 1.5 or more line cycles for voltage dips of 30 percent or more
- Third-order or higher harmonic content on the line
- Control-voltage sags of three or more line cycles for voltage dips of 40 percent or more

## Current-Overload Protection

The control panel will monitor the current drawn by each line of the motor and shut the chiller off when the highest of the three line currents exceeds the trip curve. A manual reset diagnostic describing the failure will be displayed. The current overload protection does not prohibit the chiller from reaching its full-load amperage. The chiller protects itself from damage due to current overload during starting and running modes, but is allowed to reach full-load amps.

## High Motor-Winding Temperature Protection

This function monitors the motor temperature and terminates chiller operation when the temperature is excessive. The controller monitors each of the three winding-temperature sensors any time the controller is powered up, and displays each temperature at the service menu. The controller will generate a latching diagnostic if the winding temperature exceeds 265°F (129.4°C) for 0.5–2 seconds.

## Surge Detection Protection

Surge detection is based on current fluctuations in one of three phases. The default detection criterion is two occurrences of root-mean square (RMS) current change of 30 percent within 0.8 seconds in 60 seconds  $\pm$ 10 percent. The detection criterion is adjustable with the Tracer® chiller controller.

## Overvoltage and Undervoltage Protection

While some components of the chiller are impervious to dramatically different voltages, the compressor-motor is not. The control panel monitors all three line-to-line voltages for the chiller, and bases the over and undervoltage diagnostics on the average of the three voltages. The default protection resets the unit if the line voltage is  $\pm$ 10 percent of nominal for 60 seconds.

## Power Factor and Kilowatt Measurement

Three-phase measurement of kilowatts (kW) and unadjusted power factor yields higher accuracy during power imbalance conditions.

## Short-Cycling Protection

This function mimics heat dissipation from a motor start using two setpoints: Restart Inhibit Free Starts and Restart Inhibit Start-to-Start Timer. This allows the CenTraVac™ chiller to inhibit too many starts in a defined amount of time while still allowing for fast restarts. The default for CenTraVac™ chillers is

three Free Starts and a 20 minute Start-to-Start Timer. The control panel generates a warning when the chiller is inhibited from starting by this protection.

**Restart Inhibit Free Starts:** This setting will allow a maximum number of rapid restarts equal to its value. If the number of free starts is set to 1, this will allow only one start within the time period set by the Start-to-Start Time setting. The next start will be allowed only after the start-to-start timer has expired. If the number of free starts is programmed to 3, the control will allow three starts in rapid succession, but thereafter, it would hold off on a compressor start until the Start-to-Start timer expired.

**Restart Inhibit Start-to-Start Time Setting:** This setting defines the shortest chiller cycle period possible after the free starts have been used. If the number of free starts is programmed to 1, and the Start-to-Start Time setting is programmed to 10 minutes, the compressor will be allowed one start every 10 minutes. The start-to-start time is the time from when the motor was directed to energize to when the next prestart is issued.

## Enhanced Protection Option

This optional package includes sensors and transducers that enable the following protection features:

### Enhanced Condenser-Limit Control

Includes factory-installed condenser-pressure transducer and all necessary interconnecting piping and wiring. Enhanced condenser-limit control provides high-pressure cutout avoidance by energizing a relay to initiate head relief.

*Note: This option is in addition to the standard high refrigerant-pressure safety contact.*

### Optional Compressor-Discharge Refrigerant-Temperature Protection

Includes a factory-installed sensor and safety cutout on high compressor discharge temperature. Allows the chiller controller to monitor compressor discharge temperature, which is displayed at Tracer® AdaptiView™ display, Tracer® TU, and Tracer® building controls.

*Note: When the chiller is selected with hot gas bypass, this sensor and its associated protections are included as standard.*

### Sensing of Leaving Oil Set Temperature For Each Bearing

Optional factory-installed sensors allow high-temperature safety cutouts to monitor the leaving bearing-oil temperatures. The AdaptiView display, Tracer TU, Tracer® ES, and Tracer® SC display these temperatures. The compressor thrust bearing on models CDHH and CVHH chillers has three resistance temperature detectors (RTDs) that measure the bearing pad temperature during operation. The high bearing-temperature cutout is fixed at 180°F (82.2°C). If either bearing temperature violates the cutout, a latching diagnostic will be generated.



# Chiller Selection

## Fully Customizable Chiller Selection

The CenTraVac™ chiller product line provides more than 200,000 individual unit selections over a capacity range of 120 through 4000+ cooling tons (420 through 14000+ kW). Chiller selections and performance data can be obtained through the use of the CenTraVac™ chiller selection program available in local Trane sales offices. This program can provide AHRI-certified chiller selections optimized to match specific project requirements.

### Performance

Trane Select Assist (TSA) software provides performance data for each chiller selection at the full-load design point and part-load operating points as required.

Changing the water flow rates may significantly alter the performance of a particular chiller. To obtain the maximum benefit from the wide range of selections available, designers are encouraged to develop performance specifications and use the computer selection program to optimize their selections. This will allow the selection of the particular compressor-evaporator-condenser combination that most closely meets the job requirements. All selections are made using the Trane Select Assist (TSA) selection program.

The Trane Select Assist (TSA) selection program is certified by AHRI in accordance with AHRI Standards 550/590 (I-P) and 551/591 (SI). To ensure that the specific chiller built for your project will meet the required performance, and to ensure a more trouble-free start-up, it is recommended that the chiller be performance tested on an AHRI-approved factory test loop.

The Trane Select Assist (TSA) selection program has the flexibility to select chillers for excessive field fouling allowances.

Contact your local Trane account manager for more information.

### Fouling Factors

All heat exchanger tubes are subject to a certain amount of fouling during operation due to contaminants in the water and based on water treatment at the facility. Fouling impedes heat transfer and makes the chiller work harder.

AHRI Standards 550/590 (I-P) and 551/591 (SI) include a definition of the standard fouling factors to be used in water-cooled chiller ratings. The standard fouling adjustment is a 0.0001 increment from 0.0000 ("clean") on the evaporator and 0.00025 increment from 0.0000 ("clean") on the condenser.

Chiller specifications should be developed using the most current standard fouling factors.

### Unit Performance with Fluid Media Other Than Water

CenTraVac™ chillers can be selected with a wide variety of media other than water. Typically used media include ethylene glycol or propylene glycol either in the evaporator, condenser, or both. Chillers using media other than water are excluded from the AHRI Certification Program, but are rated in accordance with AHRI Standard 550/590. Trane® factory performance tests are only performed with water as the cooling and heat rejection media. For fluid media other than water, contact your local Trane account manager for chiller selections and information regarding factory performance testing.

### Flow Rate Limits

Flow rate limits for multiple pass combinations for evaporators and condensers are tabulated in the data section for the appropriate chiller family. For applications outside of these limits, please contact your local Trane account manager.

### Roughing-in Dimensions

Dimensional drawings illustrate overall measurements of the chiller. The recommended space envelope indicates clearances required to easily service the CenTraVac™ chiller. A view of the unit with its support feet is superimposed on this drawing.

All catalog dimensional drawings are subject to change. Refer to the current submittal drawings for detailed dimensional information. If the unit must be disassembled in the field, refer to the *Installation*



*Guide: Disassembly and Reassembly Units* for your specific model chiller (CVHE-SVN04\*-EN for models CDHF, CDHG, CVHE, CVHF, and CVHG; CVHH-SVN001\*-EN for models CDHH and CVHH) for detailed information. Contact your local Trane account manager for submittal and template information.

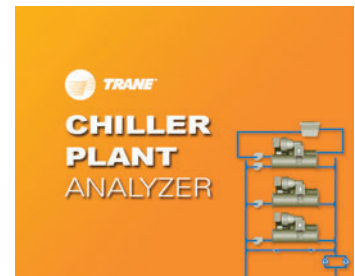
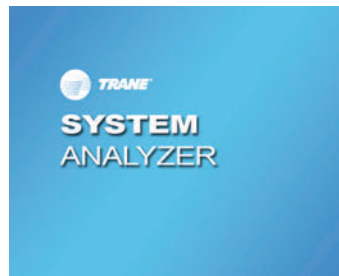
### Evaporator and Condenser Data Tables

Evaporator and condenser data is shown in “Performance Data,” p. 48 (Imperial [I-P] Units) and “Performance Data,” p. 70 (International System [SI] Units). It includes minimum and maximum water flow limits and water connection sizes for all standard pass configurations and tube types. Pressure drops are calculated by the chiller computer selection program.

### Full-Load and Part-Load Performance

The CenTraVac™ chiller possesses excellent performance characteristics over its full range of operation due to multi-stage, direct drive compressor that enables stable and efficient operation over a wide range of conditions, virtually eliminating the need for the energy-wasting hot gas bypass typically found on single-stage chillers. Reference Topps for your specific order selection for unit specific part load performance as selected. Always run selections at any expected off design conditions to verify proper expectations. .

In order to evaluate total energy costs over a period of time, an in-depth examination of project-specific conditions and energy rate structures should be performed. Trane Air Conditioning Economics, or TRACE™, is a software program that helps HVAC professionals perform this type of analysis and optimize the design of a building’s heating, ventilating and air conditioning system based on energy utilization and life-cycle cost. Visit [www.traneCDS.com](http://www.traneCDS.com) for more information.



Local utilities may offer substantial monetary rebates for centrifugal chillers with specific efficiency ratings. Contact your local utility or your local Trane account manager for further information.

The electrical rate structure is a key component of an economic evaluation. Most power bills include a significant demand charge in addition to the usage charge. The full-load power consumption of the chiller plant is likely to set the kW peak and demand charge for the billing period. This places an increased emphasis on the need to minimize the full-load power consumption of the chiller plant.

There are a number of variables that should be considered when developing a chiller load profile to compare part load performance of one chiller versus another. The use of outdoor air economizers, variations in chiller sequencing, and chiller plant load optimization strategies should be considered. Decoupled, primary/secondary water loops or variable-primary flow designs are more efficient ways to control multiple chiller water plants. These control strategies result in one chiller operating at a more fully loaded condition rather than multiple chillers operating at part load, which would require more pumping energy.

AHRI Standard 550/590 defines the entering condenser water temperatures for loads of 100, 75, 50, and 25 percent. Each point is tested, and then the Integrated Part Load Value (IPLV) can be calculated. Although some manufacturers focus on IPLV only, chiller efficiency is measured at full load and part load operation. High efficiency at full load determines the capability of the chiller to minimize the electrical infrastructure required, and reduces the impact of demand-based charges and real-time pricing during peak periods. The full load efficiency rating is required for buildings to comply with most local codes. Both full load and IPLV ratings are required for LEED® Energy and Atmosphere (EA) credits.

# myPLV Chiller Performance Evaluation Tool

The myPLV™ tool provides a simpler tool than TRACE provides for quick and reliable chiller economic comparisons considering both full and part load ratings.

The manufacturer-agnostic tool leverages industry-standard building model data, calculating four performance points (94, 75, 50 and 25 percent) based on the specific building type, location and plant design, providing accurate weighting points and condenser temperatures. The myPLV™ tool also calculates the ton-hours at each of those points necessary to accurately estimate annualized energy use.

Utilizing the myPLV™ tool from the beginning assures that the selected chiller is appropriate for the particular application. Then, myTest™ certification confirms the chiller performs as expected.

To learn more or to download a free copy of the myPLV™ tool, please visit [www.trane.com/myPLV](http://www.trane.com/myPLV).

**Figure 20. myPLV—compare chiller performance**

**myPLV™ calculator**

Unit of Measure: SI

Region: West & Central Asia

Country: Turkey (TUR)

State/territory:

City/location: Istanbul / Ataturk (3A)

Building Type and Airside Economizer: Office with Econ

Chiller Condenser Type: Water Cooled Chiller

Building Peak Load: 6000 kW

Number of Chillers in Plant: 2 \*\*Assumes equal size chillers in parallel\*\*

Size of Each Chiller: 3000 kW

Plant Capacity (Calculated Point): 6000 kW

ASHRAE 90.1 app G oversize factor (Calculated Point): 0%

Calculate myPLV™ Conditions

**myPLV™ Test and Submittal Points**

Enter chiller performance values for four submittal points.

% FL	kW	kW-hrs	weighting	ECWT	Chiller kW/kW	
25%	750	689,639	8.2%	15.5° C	0.155	
50%	1,500	2,770,231	32.9%	23.3° C	0.136	
75%	2,250	3,823,317	45.5%	26.1° C	0.135	
94%	2,820	1,128,822	13.4%	27.2° C	0.138	
design	3,000		0%	29.4° C	0.151	
Total kW-hrs		8,412,009			myPLV™	
					Annualized kWh	1,155,571



# Unit Specifications – Imperial (I-P) Units

## Performance Data

Table 6. Minimum and maximum evaporator flow rates (gpm) — CDHF, CDHG, CVHE, CVHF, and CVHG chillers

Shell Size EVSZ	Bundle Size EVBS	One Pass						Two Pass						Three Pass					
		IECU/IMCU		IMC1		TECU		IECU/IMCU		IMC1		TECU		IECU/IMCU		IMC1		TECU	
		Min	Max	Min	Max	Min	Max	Min	Max	Min	Max	Min	Max	Min	Max	Min	Max	Min	Max
032S	200	155	1137	—	—	241	1325	78	568	—	—	120	662	52	379	—	—	80	442
	230	179	1312	—	—	270	1486	89	656	—	—	135	743	60	437	—	—	90	495
	250	191	1399	—	—	297	1635	95	700	—	—	149	818	64	466	—	—	99	545
032S/L	280	216	1596	219	1603	339	1866	108	798	109	801	170	933	72	532	73	534	113	622
	320	245	1814	249	1822	379	2085	123	907	124	911	190	1042	82	605	83	607	126	695
	350	269	1989	272	1998	—	—	134	995	136	999	—	—	90	663	91	666	—	—
050S/L	390	310	2273	—	—	473	2603	155	1137	—	—	237	1301	103	758	—	—	158	868
	480	370	2711	—	—	578	3179	185	1355	—	—	289	1589	123	904	—	—	193	1060
	580	447	3279	—	—	691	3801	224	1640	—	—	346	1900	149	1093	—	—	230	1267
	700	538	3979	545	3996	813	4469	269	1989	272	1998	406	2234	179	1326	182	1332	271	1490
	860	650	4809	659	4831	—	—	325	2405	329	2415	—	—	217	1603	220	1610	—	—
080S/L	740	579	4285	587	4304	—	—	290	2142	293	2152	—	—	193	1428	196	1435	—	—
	880	686	5028	—	—	959	1676	343	2514	—	—	480	2638	229	1676	—	—	320	1758
	1050	841	6165	—	—	1097	6035	420	3082	—	—	549	3018	280	2055	—	—	366	2012
	1210	978	7170	—	—	1227	6749	489	3585	—	—	614	3375	326	2390	—	—	409	2250
	1400	1135	8394	1150	8432	1411	7763	567	4197	575	4216	706	3881	378	2798	383	2811	470	2588
142M/L	960	750	5516	761	5577	—	—	375	2758	380	2789	—	—	250	1839	254	1859	—	—
	1200	898	6601	910	6675	920	6749	449	3301	455	3338	460	3375	299	2200	303	2225	307	2250
	1320	1058	7774	1072	7861	1037	7602	529	3887	536	3930	518	3801	353	2591	357	2620	346	2534
	1600	1194	8773	1210	8871	1156	8477	597	4386	605	4435	578	4238	398	2924	403	2957	385	2826
	1750	1347	9902	1365	10013	1307	9583	674	4951	683	5006	653	4791	449	3301	455	3338	436	3194
	1890	1460	10727	1479	10847	1407	10320	730	5364	740	5423	704	5160	487	3576	493	3616	469	3440
142E	960	752	5552	761	5577	—	—	376	2776	380	2789	—	—	251	1851	254	1859	—	—
	1200	900	6645	910	6675	920	6749	450	3323	455	3338	460	3375	300	2215	303	2225	307	2250
	1320	1060	7826	1072	7861	1037	7602	530	3913	536	3930	518	3801	353	2609	357	2620	346	2534
	1600	1196	8831	1210	8871	1156	8477	598	4416	605	4435	578	4238	399	2944	403	2957	385	2826
	1750	1350	9968	1365	10013	1307	9583	675	4984	683	5006	653	4791	450	3323	455	3338	436	3194
	1890	1463	10799	1479	10847	1407	10320	731	5399	740	5423	704	5160	488	3600	493	3616	469	3440
210L	1610	1229	9013	1246	9134	1470	8085	615	4507	623	4567	735	4043	410	3004	415	3045	490	2695
	1760	1380	10118	1398	10254	1642	9030	690	5059	699	5127	821	4515	460	3373	466	3418	547	3010
	1900	1525	11180	1545	11330	1824	10032	762	5590	772	5665	912	5016	508	3727	515	3777	608	3344
	2100	1619	11873	1641	12033	2010	11057	810	5937	820	6016	1005	5528	540	3958	547	4011	670	3686
250E	2280	1616	11848	—	—	2002	11011	808	5924	—	—	1001	5505	—	—	—	—	—	—
	2300	1762	12919	—	—	2174	11955	881	6460	—	—	1087	5978	587	4306	—	—	725	3985
	2480	1789	13116	—	—	2201	12105	894	6558	—	—	1100	6052	—	—	—	—	—	—
	2500	1929	14144	—	—	2394	13165	964	7072	—	—	1197	6582	643	4715	—	—	798	4388



## Unit Specifications – Imperial (I-P) Units

**Table 6. Minimum and maximum evaporator flow rates (gpm) — CDHF, CDHG, CVHE, CVHF, and CVHG chillers (continued)**

Shell Size EVSZ	Bundle Size EVBS	One Pass						Two Pass						Three Pass					
		IECU/IMCU		IMC1		TECU		IECU/IMCU		IMC1		TECU		IECU/IMCU		IMC1		TECU	
		Min	Max	Min	Max	Min	Max	Min	Max	Min	Max	Min	Max	Min	Max	Min	Max	Min	Max
210D	1610	1224	8975	—	—	1421	7816	—	—	—	—	—	—	—	—	—	—	—	—
	1850	1397	10244	—	—	1680	9241	—	—	—	—	—	—	—	—	—	—	—	—
	2100	1567	11493	—	—	1935	10643	—	—	—	—	—	—	—	—	—	—	—	—
250D/M/X	2100	1567	11493	—	—	1943	10688	—	—	—	—	—	—	—	—	—	—	—	—
	2300	1734	12719	—	—	2101	11556	—	—	—	—	—	—	—	—	—	—	—	—
	2500	1899	13925	—	—	2314	12725	—	—	—	—	—	—	—	—	—	—	—	—

*Note: The minimum evaporator water velocity is 1.5 ft/s for IECU tubes and 2.0 ft/s for all other tubes. For a variable evaporator water flow system, the minimum GPME is generally not applicable at full load, and may be limited by other factors such as glycol. Confirm actual minimum and maximum flows for each selection before operating near flow boundaries. Values in this table are based on 0.025-in. wall tubes for M, L, S, and E bundles and 0.028-in. wall tubes for D, M, and X bundles.*

**Table 7. Minimum and maximum condenser flow rates (gpm) — CDHF, CDHG, CVHE, CVHF, and CVHG chillers**

Shell Size CDSZ	Bundle Size CDBS	One Pass						Two Pass					
		IMCU		TECU		IECU		IMCU		TECU		IECU	
		Min	Max	Min	Max	Min	Max	Min	Max	Min	Max	Min	Max
032S	230	432	1584	417	1528	434	1592	216	792	208	764	217	796
032S/L	250	487	1785	466	1715	489	1793	243	892	233	857	245	897
	280	541	1985	521	1916	544	1995	271	993	260	958	272	997
	320	607	2226	576	2118	610	2236	304	1113	288	1059	305	1118
050S	360	689	2527	655	2403	692	2539	345	1263	328	1201	346	1269
050S/L	400	777	2848	738	2713	780	2861	388	1424	369	1357	390	1431
	450	875	3209	831	3056	879	3224	438	1604	415	1528	440	1612
	500	974	3570	887	3357	928	3586	487	1785	467	1718	489	1793
080S	500	974	3570	921	3378	978	3586	487	1785	461	1689	489	1793
	560	1088	3991	1031	3780	1093	4009	544	1995	515	1890	547	2005
080S/L	630	1220	4472	1160	4266	1225	4493	610	2236	580	2133	613	2247
	710	1367	5014	1311	4821	1374	5037	684	2507	655	2410	687	2519
	800	1537	5635	1472	5398	1544	5662	768	2818	739	2708	772	2831
142L	890	1739	6378	1667	6112	1747	6407	870	3189	833	3056	874	3204
	980	1936	7100	1854	6798	1945	7132	968	3550	927	3399	973	3566
	1080	2166	7942	2071	7595	2176	7979	1083	3971	1036	3797	1088	3989
	1220	2418	8864	2316	8492	2429	8905	1209	4432	1158	4246	1214	4453
	1420	2795	10248	2610	9571	2808	10296	1397	5124	1305	4786	1404	5148
210L	1610	2970	10890	2602	9541	2984	10940	1485	5445	1301	4771	1492	5470
	1760	3287	12053	2880	10560	3302	12109	1644	6027	1440	5280	1651	6055
	1900	3599	13196	3158	11578	3616	13257	1799	6598	1579	5789	1808	6629
	2100	3900	14299	3441	12617	3918	14366	1950	7150	1721	6309	1959	7183
250L	2100	3894	14279	3441	12617	3912	14345	1947	7140	1721	6309	1956	7173
	2300	4277	15683	3782	13868	4297	15756	2139	7842	1891	6934	2149	7878
	2500	4655	17067	4131	15149	4676	17146	2327	8533	2066	7574	2338	8573



## Unit Specifications – Imperial (I-P) Units

**Table 7. Minimum and maximum condenser flow rates (gpm) — CDHF, CDHG, CVHE, CVHF, and CVHG chillers (continued)**

Shell Size CDSZ	Bundle Size CDBS	One Pass						Two Pass					
		IMCU		TECU		IECU		IMCU		TECU		IECU	
		Min	Max	Min	Max	Min	Max	Min	Max	Min	Max	Min	Max
210D	1610	2970	10890	2602	9541	2984	10940	—	—	—	—	—	—
	1760	3287	12053	2880	10560	1421	12109	—	—	—	—	—	—
	1900	3599	13196	3158	11578	1680	13257	—	—	—	—	—	—
	2100	3900	14299	3441	12617	3918	14366	—	—	—	—	—	—
250D/M/X	2100	3894	14279	3441	12617	3912	14345	—	—	—	—	—	—
	2300	4277	15683	3782	13868	4297	15756	—	—	—	—	—	—
	2500	4655	17067	4131	15149	4676	17146	—	—	—	—	—	—

**Note:** The minimum condenser water velocity is 3 ft/s and the maximum is 11 ft/s and may be limited by other factors such as glycol. Confirm actual minimum and maximum flows for each selection before operating near flow boundaries. Values in this table are based on 0.028-in. wall tubes.

**Table 8. Minimum and maximum evaporator flow rates (gpm) — CDHH and CVHH chillers**

Shell Size (EVSZ)	Bundle Size (EVBS)	Tube Type																			
		IECU				IMC1				TECU				IMCU							
		Number of Passes																			
		1		2		3		1		2		3		1		2		3		1	
		Min	Max	Min	Max	Min	Max	Min	Max	Min	Max	Min	Max	Min	Max	Min	Max	Min	Max	Min	Max
100M	810	762	5589	393	2706	264	1826	761	5577	392	2701	263	1822	716	5254	367	2565	252	1703	—	—
	870	810	5941	417	2882	282	1936	808	5928	416	2876	281	1932	753	5523	385	2700	264	1792	—	—
	1000	972	7129	501	3454	330	2354	970	7114	500	3447	329	2349	860	6307	440	3081	298	2061	—	—
100L	810	762	5589	393	2706	264	1826	761	5577	392	2701	263	1822	716	5254	367	2565	252	1703	—	—
	870	810	5941	417	2882	282	1936	808	5928	416	2876	281	1932	753	5523	385	2700	264	1792	—	—
	1000	972	7129	501	3454	330	2354	970	7114	500	3447	329	2349	860	6307	440	3081	298	2061	—	—
130M	1040	975	7151	501	3476	330	2310	973	7136	500	3469	329	2306	877	6430	448	3148	296	2084	—	—
	1140	1074	7877	552	3829	363	2552	1072	7861	551	3821	362	2547	952	6979	486	3417	322	2252	—	—
	1300	1191	8735	612	4247	414	2662	1189	8717	611	4238	413	2657	1027	7528	524	3686	353	2353	—	—
160M	1290	1212	8889	606	4445	405	2948	1210	8871	605	4435	404	2942	1062	7786	541	3820	354	2588	—	—
	1390	1341	9835	672	4907	447	3278	1338	9815	671	4896	446	3272	1149	8424	574	4212	383	2801	—	—
	1600	1521	11155	762	5567	507	3718	1518	11132	761	5555	506	3711	1280	9388	640	4694	428	3126	—	—
200L	1520	1296	9505	678	4533	—	—	1293	9486	677	4523	—	—	1166	8548	606	4100	414	2655	—	—
	1680	1455	10671	744	5215	501	3322	1452	10649	743	5204	500	3316	1300	9533	674	4593	466	3025	—	—
	1840	1590	11662	834	5545	558	3498	1587	11637	832	5533	557	3491	1427	10463	738	5052	518	3294	—	—
	2000	1704	12498	915	5787	627	3674	1701	12472	913	5775	626	3667	1525	11180	849	4952	581	3450	—	—
220L	1850	1809	13268	905	6634	603	4423	1805	13240	903	6620	602	4413	1567	11494	784	5747	522	3831	—	—
	2000	1998	14654	999	7327	666	4885	1994	14624	997	7312	665	4875	1720	12614	860	6307	573	4205	—	—
	2200	2268	16634	1134	8317	756	5545	2264	16600	1132	8300	755	5533	1974	14474	987	7237	658	4825	—	—
400M	3040	1296	9505	—	—	—	—	—	—	—	—	—	—	1198	8788	—	—	—	—	1288	9444
	3360	1455	10671	—	—	—	—	—	—	—	—	—	—	1337	9801	—	—	—	—	1446	10602
	3680	1590	11662	—	—	—	—	—	—	—	—	—	—	1467	10757	—	—	—	—	1580	11586
	4000	1704	12498	—	—	—	—	—	—	—	—	—	—	1567	11494	—	—	—	—	1693	12417

## Unit Specifications – Imperial (I-P) Units

**Table 8. Minimum and maximum evaporator flow rates (gpm) — CDHH and CVHH chillers (continued)**

Shell Size (EVSZ)	Bundle Size (EVBS)	Tube Type																			
		IECU						IMC1						TECU						IMCU	
		Number of Passes																			
		1		2		3		1		2		3		1		2		3		1	
Min	Max	Min	Max	Min	Max	Min	Max	Min	Max	Min	Max	Min	Max	Min	Max	Min	Max	Min	Max		
440M	3700	1809	13268	—	—	—	—	—	—	—	—	—	—	1611	11817	—	—	—	—	1797	13182
	4000	1998	14654	—	—	—	—	—	—	—	—	—	—	1768	12969	—	—	—	—	1985	14559
	4400	2268	16634	—	—	—	—	—	—	—	—	—	—	2029	14881	—	—	—	—	2254	16526
440X	3700	1809	13268	—	—	—	—	—	—	—	—	—	—	1611	11817	—	—	—	—	1797	13182
	4000	1998	14654	—	—	—	—	—	—	—	—	—	—	1768	12969	—	—	—	—	1985	14559
	4400	2268	16634	—	—	—	—	—	—	—	—	—	—	2029	14881	—	—	—	—	2254	16526

**Table 9. Minimum and maximum condenser flow rates (gpm) — CDHH and CVHH chillers**

Shell Size (CDSZ)	Bundle Size (CDBS)	Tube Type											
		IECU				IMCU				TECU			
		Number of Passes											
		1		2		1		2		1		2	
Min	Max	Min	Max	Min	Max	Min	Max	Min	Max	Min	Max	Min	Max
100M	810	2078	7621	1039	3810	2112	7745	1056	3873	1853	6796	927	3398
	870	2292	8403	1146	4202	2329	8540	1165	4270	2034	7459	1017	3730
	1000	2461	9025	1231	4512	2501	9172	1251	4586	2193	8042	1097	4021
100L	810	2078	7621	1039	3810	2112	7745	1056	3873	1853	6796	927	3398
	870	2292	8403	1146	4202	2329	8540	1165	4270	2034	7459	1017	3730
	1000	2461	9025	1231	4512	2501	9172	1251	4586	2193	8042	1097	4021
10HM	810	2089	7661	1045	3831	2123	7786	1062	3893	1853	6796	927	3398
	870	2286	8383	1143	4192	2324	8520	1162	4260	2034	7459	1017	3730
	1000	2456	9005	1228	4502	2496	9151	1248	4576	2223	8153	1112	4076
130M	1040	2593	9506	1296	4753	2635	9661	1317	4830	2314	8485	1157	4242
	1140	2844	10429	1422	5214	2891	10599	1445	5299	2544	9329	1272	4664
	1300	3085	11311	1542	5656	3135	11495	1568	5748	2747	10073	1374	5036
13HM	1040	2593	9506	1296	4753	2635	9661	1317	4830	2314	8485	1157	4242
	1140	2844	10429	1422	5214	2891	10599	1445	5299	2544	9329	1272	4664
	1300	3085	11311	1542	5656	3135	11495	1568	5748	2747	10073	1374	5036
200M	1520	2954	10830	1477	5415	3002	11006	1501	5503	2594	9510	1297	4755
	1680	3282	12033	1641	6017	3335	12229	1668	6115	2865	10505	1433	5253
	1840	3610	13236	1805	6618	3669	13452	1834	6726	3142	11520	1571	5760
	2000	3900	14299	1950	7150	3963	14532	1982	7266	3422	12546	1711	6273
200L	1520	2954	10830	1477	5415	3002	11006	1501	5503	2594	9510	1297	4755
	1680	3282	12033	1641	6017	3335	12229	1668	6115	2865	10505	1433	5253
	1840	3610	13236	1805	6618	3669	13452	1834	6726	3142	11520	1571	5760
	2000	3883	14239	1942	7120	3947	14471	1973	7236	3422	12546	1711	6273



## Unit Specifications – Imperial (I-P) Units

**Table 9. Minimum and maximum condenser flow rates (gpm) — CDHH and CVHH chillers (continued)**

Shell Size (CDSZ)	Bundle Size (CDBS)	Tube Type											
		IECU				IMCU				TECU			
		Number of Passes											
		1		2		1		2		1		2	
		Min	Max	Min	Max	Min	Max	Min	Max	Min	Max	Min	Max
20HM	1520	2954	10830	1477	5415	3002	11006	1501	5503	2594	9510	1297	4755
	1680	3282	12033	1641	6017	3335	12229	1668	6115	2860	10485	1430	5243
	1840	3610	13236	1805	6618	3669	13452	1834	6726	3142	11520	1571	5760
	2000	3763	13798	1882	6899	3824	14023	1912	7011	3282	12033	1641	6017
220L	1850	3900	14299	1950	7150	3963	14532	1982	7266	3422	12546	1711	6273
	2000	4283	15703	2141	7852	4352	15959	2176	7979	3756	13772	1878	6886
	2200	4633	16987	2316	8493	4708	17263	2354	8632	4110	15069	2055	7535
22HL	1850	3894	14279	1947	7140	3958	14512	1979	7256	3422	12546	1711	6273
	2000	4288	15723	2144	7862	4358	15979	2179	7990	3756	13772	1878	6886
	2200	4627	16967	2314	8483	4703	17243	2351	8621	4112	15079	2056	7540
440M	3700	3900	14299	—	—	3963	14532	—	—	3422	12546	—	—
	4000	4283	15703	—	—	4352	15959	—	—	3756	13772	—	—
	4400	4633	16987	—	—	4708	17263	—	—	4110	15069	—	—
440X	3700	3900	14299	—	—	3963	14532	—	—	3422	12546	—	—
	4000	4283	15703	—	—	4352	15959	—	—	3756	13772	—	—
	4400	4633	16987	—	—	4708	17263	—	—	4110	15069	—	—
44HM	3700	3900	14299	—	—	3963	14532	—	—	3422	12546	—	—
	4000	4283	15703	—	—	4352	15959	—	—	3756	13772	—	—
	4400	4633	16987	—	—	4708	17263	—	—	4110	15069	—	—
44HX	3700	3900	14299	—	—	3963	14532	—	—	3422	12546	—	—
	4000	4283	15703	—	—	4352	15959	—	—	3756	13772	—	—
	4400	4633	16987	—	—	4708	17263	—	—	4110	15069	—	—

## Weights (lb)

**Important:** The weight information provided here should be used for general information only. Trane does not recommend using this weight information for considerations relative to chiller handling, rigging, or placement. The large number of variances between chiller selections drives variances in chiller weights that are not recognized in these tables. For specific weights for your chiller, refer to your submittal package.

**Table 10. Representative weights, 60 Hz chillers (lb) — CVHE, CVHF, and CDHF chillers**

Model	Comp Size	CPKW	Evap Size	Cond Size	Weights without Starters		Weights with Starters	
	NTON		EVSZ	CDSZ	Operating	Shipping	Operating	Shipping
CVHE	230–320	233	032S	032S	14828	13469	—	—
		289			—	—	16508	15149
	230–320	289	032S	032L	15433	13924	17113	15604
	230–320	289	032L	032L	16277	14574	17957	16254
	230–320	289	050S	050S	20035	17599	21715	19279
	230–320	289	050S	050L	21001	18356	22681	20036
	230–320	289	050L	050L	22352	19304	24032	20984
	360–500	455	050S	050S	20717	18281	22397	19961
	360–500	455	050S	050L	21683	19038	23363	20718
	360–500	455	050L	050L	23034	19986	24714	21666
	360–500	455	050S	080S	23200	20265	24880	21945
	360–500	455	050L	080L	26793	22976	28473	24656
	360–500	455	080S	080S	29854	25634	31534	27314
	360–500	455	080S	080L	31442	26917	33122	28597
	360–500	455	080L	080L	33463	28333	35143	30013



## Unit Specifications – Imperial (I-P) Units

**Table 10. Representative weights, 60 Hz chillers (lb) — CVHE, CVHF, and CDHF chillers (continued)**

Model	Comp Size	CPKW	Evap Size	Cond Size	Weights without Starters		Weights with Starters	
	NTON		EVSZ	CDSZ	Operating	Shipping	Operating	Shipping
CVHF	350–570	588	050S	050S	20487	17984	22167	19664
	350–570	588	050S	050L	21453	18741	23133	20421
	350–570	588	050L	050L	22703	19567	24383	21247
	350–570	588	050S	080S	22970	19968	24650	21648
	350–570	588	050L	080L	26512	22557	28192	24237
	350–570	588	080S	080S	31845	26997	32173	27715
	350–570	588	080S	080L	32131	27318	33811	28998
	350–570	588	080L	080L	34319	28855	35999	30535
	350–910	957	080S	080S	32843	28385	35843	31385
	350–910	957	080S	080L	34481	29668	37481	32668
	350–910	957	080L	080L	36669	31205	39669	34205
	350–910	957	080L	142L	44814	37663	47814	40663
	350–910	957	142M	142L	48446	40540	51446	43540
	350–910	957	142L	142L	49667	41453	52667	44453
	1070–1300	1062	080L	142L	45710	38559	48710	41559
	1070–1300	1062	142M	142L	49116	41210	52116	44210
	1070–1300	1062	142L	142L	50337	42123	53337	45123
	1070–1300	1062	142E	142L	51762	43109	54762	46109
	1070–1300	1062	142M	210L	55062	46057	58062	49057
	1070–1300	1062	142L	210L	56333	46970	59333	49970
	1070–1300	1062	142E	210L	57758	47956	60758	50956
	1070–1300	1062	210L	210L	61899	51929	64899	54929
	1070–1300	1062	250E	250L	76152	63330	79152	66330
	1470	1340	210L	210L	64550	54580	67550	57580
1470–1720	1340	142L	210L	58984	49621	61984	52621	
1470–1720	1340	250E	250L	78803	65981	81803	68981	
CDHF	1500–2000	745	210D	210D	95319	80069	101319	86069
	2170–2550	1062	250D	250D	110325	91405	116325	97405
	3000	1062	250M	250M	125690	103670	131690	109670
	3500	957	250X	250X	—	—	133835	109305
		1229			138730	114199	—	—

**Notes:**

1. TECU tubes, 0.028 in. tube wall thickness.
2. 300 psig marine waterboxes.
3. Heaviest possible bundle and motor combination.
4. Operating weights assume the largest possible refrigerant charge.
5. Weights with starters assume the heaviest possible starter (AFD when it's an allowed option).
6. Industrial Control Panel (INDP) option, add 50 lb.
7. Control Power Transformer (CPTR) option, add 130 lb.
8. Supplemental Motor Protection (SMP) option, add 500 lb.

**Table 11. Representative weights, 60 Hz chillers (lb)**

Model	Comp Size	CPKW	Evap Size	Cond Size	Weights without Starters	
	NTON		EVSZ	CDSZ	Operating	Shipping
CVHH	900–1200	1228	100M	100M	47451	41071
	900–1200	1228	100L	100L	49252	42368
	900–1200	1340	100M	10HM	54999	47798
	900–1200	1340	130M	130M	52868	44894
	900–1200	1340	130M	13HM	62184	53398
	900–1200	1340	160M	200M	63653	53621
	900–1200	1340	200L	220L	71963	58931
	900–1200	1340	220L	220L	79082	64664
	1500–1700	1340	200L	200L	70921	59137
	1500–1700	1340	200L	20HL	80262	67562
	1500–1700	1340	220L	220L	79082	64664
	1500–1700	1340	220L	22HL	93396	78060
CDHH	2000–2600	1340	400M	440M	124422	100930
	2800–3300	1340	440M	440M	134278	108299
	2800–3300	1340	440X	440X	141614	113420
	2000–2600	1340	440M	44HM	159702	121963
	2800–3300	1340	440X	44HX	171753	129265

**Notes:**

1. TECU tubes, 0.028 in. tube wall thickness.
2. 300 psig marine waterboxes.
3. Heaviest possible bundle and motor combination.
4. Operating weights assume the largest possible refrigerant charge.
5. Industrial Control Panel (INDP) option, add 50 lb.
6. Control Power Transformer (CPTR) option, add 280 lb.
7. Supplemental Motor Protection (SMP) option, add 500 lb.
8. To calculate the maximum chiller weight with starter/drive, add the starter/AFD weight from the following table (maximum weights, unit-mounted starters/AFDs [lb]) to the chiller maximum weight from this table. Note that Duplex™ chiller models CDHH will have two starters, one for each compressor.



## Unit Specifications – Imperial (I-P) Units

**Table 12. Representative weights, 50 Hz chillers (lb) — CVHE, CVHG, and CDHG chillers**

Model	Comp Size	CPKW	Evap Size	Cond Size	Weights without Starters		Weights with Starters	
	NTON		EVSZ	CDSZ	Operating	Shipping	Operating	Shipping
CVHE	190–320	215	032S	032S	14785	13426	—	—
		231			—	—	16456	15097
	190–320	215	032S	032L	15390	13881	—	—
		231			—	—	17061	15552
	190–320	215	032L	032L	16234	14531	—	—
		231			—	—	17905	16202
	190–320	215	050S	050S	19696	17195	—	—
		231			—	—	21419	18918
	190–320	215	050S	050L	20712	17952	—	—
		231			—	—	22435	19675
	190–320	215	050L	050L	21829	18682	—	—
		231			—	—	23636	20502
	300–500	360	050S	050S	21307	18806	—	—
		379			—	—	22608	20107
	300–500	360	050S	050L	22323	19563	—	—
		379			—	—	23624	20864
	300–500	360	050L	050L	23524	20390	—	—
		379			—	—	24825	21691
	300–500	360	050S	080S	24923	21589	—	—
		379			—	—	26224	22890
300–500	360	080S	080S	30740	26520	—	—	
	379			—	—	32041	27821	
300–500	360	080S	080L	32328	27803	—	—	
	379			—	—	33629	29104	
300–500	360	080L	080L	34349	29219	—	—	
	379			—	—	35650	30520	



## Unit Specifications – Imperial (I-P) Units

**Table 12. Representative weights, 50 Hz chillers (lb) — CVHE, CVHG, and CDHG chillers (continued)**

Model	Comp Size	CPKW	Evap Size	Cond Size	Weights without Starters		Weights with Starters	
	NTON		EVSZ	CDSZ	Operating	Shipping	Operating	Shipping
CVHG	480–565	489	050S	050S	22258	19747	22815	20304
	480–565	489	050S	050L	23274	20504	23831	21061
	480–565	489	050L	050L	24391	21244	24948	21801
	480–565	489	050S	080S	25874	22538	26431	23095
	480–565	489	050L	080L	28712	24647	29269	25204
	480–565	489	080S	080L	33279	28754	33836	29311
	670–780	621	080S	080S	32952	28732	33509	29289
	670–780	621	080S	080L	34540	30015	35097	30572
	670–780	621	080L	080L	36561	31431	37118	31988
	670–780	621	080L	142L	45020	38203	45577	38760
	670–780	621	142M	142L	49518	41562	50075	42119
	670–780	621	142L	142L	50789	42475	51346	43032
	920–1100	621	080L	142L	46086	39269	46643	39826
	920–1100	892	142M	142L	50988	43032	51545	43589
	920–1100	892	142L	142L	52259	43945	52816	44502
	920–1100	892	142M	210L	56984	47879	57541	48436
	920–1100	892	142L	210L	58205	48792	58762	49349
	920–1100	892	142E	210L	59630	49778	60187	50335
	920–1100	892	210L	210L	63821	53751	64378	54308
CDHG	1250	621	210D	210D	99463	84013	100577	85127
	1750	621	210D	210D	99463	84013	100577	85127
	2150	892	210D	210D	103720	88298	104834	89412
	2250	892	210D	210D	102408	86953	103522	88067

**Notes:**

1. TECU tubes, 0.028 in. tube wall thickness.
2. 300 psig marine waterboxes.
3. Heaviest possible bundle and motor combination.
4. Operating weights assume the largest possible refrigerant charge.
5. Weights with starters assume the heaviest possible starter (AFD when it's an allowed option).
6. Industrial Control Panel (INDP) option, add 50 lb.
7. Control Power Transformer (CPTR) option, add 130 lb.
8. Supplemental Motor Protection (SMP) option, add 500 lb.



## Unit Specifications – Imperial (I-P) Units

**Table 13. Representative weights, 50Hz chillers (lb)**

Model	Comp Size	CPKW	Evap Size	Cond Size	Weights without Starters	
	NTON		EVSZ	CDSZ	Operating	Shipping
CVHH	950–1050	1023	100M	100M	49024	42643
	950–1050	1023	100L	100L	50824	43940
	950–1050	1023	100M	10HM	56723	49522
	950–1050	1023	130M	130M	54592	46618
	950–1050	1023	130M	13HM	63908	55122
	950–1050	1023	160M	200M	65377	55345
	950–1050	1023	200L	220L	73687	60655
	950–1050	1023	220L	220L	80806	66388
	1550	1023	200L	200L	72345	60561
	1550	1023	200L	20HL	81686	68986
	1550	1023	220L	220L	80506	66088
	1550	1023	220L	22HL	94820	79484
CDHH	1750–2250	1023	400M	440M	127870	104378
	3050	1023	440M	440M	137126	111147
	3050	1023	440X	440X	144462	116268
	3050	1023	440M	44HM	164929	127190
	3050	1023	440X	44HX	175825	133337

**Notes:**

1. TECU tubes, 0.028 in. tube wall thickness.
2. 300 psig marine waterboxes.
3. Heaviest possible bundle and motor combination.
4. Operating weights assume the largest possible refrigerant charge.
5. Industrial Control Panel (INDP) option, add 50 lb.
6. Control Power Transformer (CPTR) option, add 280 lb.
7. Supplemental Motor Protection (SMP) option, add 500 lb.
8. To calculate the maximum chiller weight with starter/drive, add the starter/AFD weight from the following table (maximum weights, unit-mounted starters/AFDs [lb]) to the chiller maximum weight from this table. Note that Duplex™ chiller models CDHH will have two starters, one for each compressor.

**Table 14. Maximum weights, unit-mounted starters/Adaptive Frequency™ Drives (AFDs) (lb)**

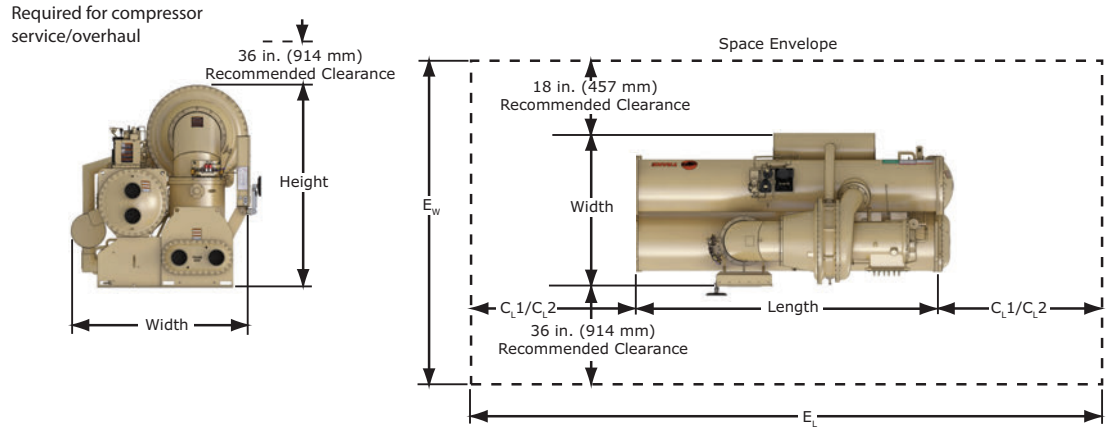
<b>Low Voltage (less than 600 volts)</b>	Wye-delta	557
<b>Adaptive Frequency Drive (less than 600 volts)</b>	900 amp	3000
	1210 amp	3000
<b>Medium Voltage (2300–6600 volts)</b>	Across-the-line	652
	Primary Reactor	1602
	Autotransformer	1702

*Note: All weights are nominal and ±10%.*

# Physical Dimensions

## Single Compressor Chillers

**Figure 21. Space envelope for 60 and 50 Hz single compressor chillers — CVHE, CVHF, CVHG, and CVHH chillers (CVHF unit shown)**



**Note:** Physical dimensions without unit-mounted starters. Refer to the following tables for I-P data for single compressor CenTraVac™ chillers; refer to “Single Compressor Chillers,” p. 81 for SI data for single compressor CenTraVac™ chillers.

**Table 15. Chiller water connection pipe size (in.) — CVHE, CVHF, and CVHG chillers**

Water Passes	Shell Size					
	032	050	080	142	210	250
Evaporator	Nominal Pipe Size					
1 Pass	8	10	12	16	16	16
2 Pass	6	8	10	12	14	14
3 Pass	5	6	8	10	12	12
Condenser	Nominal Pipe Size					
1 Pass	8	10	12	16	16	16
2 Pass	6	8	10	12	14	14

**Table 16. Chiller water connection pipe size (in.) — CVHH chillers**

Water Passes	Shell Size				
	100	130	160	200	220
Evaporator	Nominal Pipe Size				
1 Pass	12	12	14	16	20
2 Pass	10	10	12	14	14
3 Pass	8	8	10	12	12
Condenser	Nominal Pipe Size				
1 Pass	12	14	—	16	24
2 Pass	10	12	—	14	14



## Unit Specifications – Imperial (I-P) Units

**Table 17. Physical dimensions for 60 Hz compressor chillers (in.) — CVHE, and CVHF chillers**

Model	Comp Size	Shell Size	Shell Arrange	Envelope				Clearance		Base Unit Dimensions			
				Length	Width			Tube Pull					
					Terminal Box Only	LV Unit Mounted Starters <sup>(a)</sup>	LV Unit Mounted AFD						
				E <sub>L</sub>	E <sub>W</sub>	E <sub>W</sub>	E <sub>W</sub>	C <sub>L1</sub>	C <sub>L2</sub>	Length	Height	Width	
CVHE	230–320	032	SS	317	132	134	150	141	41	135.0	93.8	69.1	
			SL / LL	408	132	134	150	186	41	180.3	93.8	69.1	
	050	SS	318	135	147	158	141	42	135.0	98.3	80.6		
		SL / LL	409	135	147	158	186	42	180.3	98.3	80.6		
	360–500	050	SS	318	135	147	158	141	42	135.0	98.7	80.5	
			SL / LL	409	135	147	158	186	42	180.3	98.7	80.5	
		050/080	SS	328	144	149	167	141	52	135.0	103.8	90.3	
			LL	419	144	149	167	186	52	180.3	103.8	90.3	
		080	SS	328	153	158	168	141	52	135.0	114.9	96.8	
			SL / LL	419	153	158	168	186	52	180.3	114.9	96.8	
CVHF	350–570	050	SS	318	134	147	149	141	42	135.0	100.0	80.4	
			SL / LL	409	134	147	149	186	42	180.3	100.0	80.4	
		050/080	SS	328	144	149	167	141	52	135.0	103.6	90.2	
			LL	419	144	149	167	186	52	180.3	103.6	90.2	
		080	SS	328	152	157	167	141	52	135.0	114.7	96.7	
	SL / LL		419	152	157	167	186	52	180.3	114.7	96.7		
	650–910	080	SS	328	161	157	175	141	52	135.0	114.9	97.2	
			SL / LL	419	161	157	175	186	52	180.3	114.9	97.2	
		080/142	LL	426	175	175	198	186	59	180.3	117.8	120.9	
	1070–1300	142	ML / LL	426	172	169	196	186	59	180.3	121.3	115.4	
			080/142	LL	426	177	176	199	186	59	180.3	121.6	121.7
		142	ML / LL	426	177	173	199	186	59	180.3	121.5	118.3	
			EL	471	177	173	199	209	59	202.8	121.5	118.3	
		142/210	ML / LL	426	185	181	210	186	59	180.3	128.9	126.8	
			EL	471	185	181	210	209	59	202.8	128.9	126.8	
		210	LL	426	182	178	204	186	59	180.3	135.2	124.8	
			EL	474	191	195	212	209	62	202.8	139.3	137.3	
		1470–1720	142/210	LL	426	181	187	207	186	59	180.3	130.9	126.9
				EL	471	181	187	207	209	59	202.8	130.9	126.9
	210		LL	426	189	186	205	186	59	180.3	137.2	124.7	
EL			474	191	195	212	209	62	202.8	141.4	137.3		

**Notes:**

1. C<sub>L1</sub> can be at either end of the machine and is required for tube pull clearance.
2. C<sub>L2</sub> is always at the opposite end of the machine from C<sub>L1</sub> and is required for service clearance.
3. DMP = Differential Motor Protection
4. SMP = Supplemental Motor Protection, no unit-mounted starter
5. CPTR = Control Power Transformer option, no unit-mounted starter
6. Refer to [Figure 21, p. 59](#) for the space envelope for single compressor CenTraVac™ chillers.

<sup>(a)</sup> Dimensions for low-voltage unit-mounted starters. Medium-voltage starters are also available for unit mounting.

## Unit Specifications – Imperial (I-P) Units

**Table 18. Physical dimensions for 50 and 60 Hz single compressor chillers (in.) — CVHH chillers**

Units	Comp Size	Shell Configuration Evap/Cond	Space Envelope		Clearance		Base Unit Dimensions		
			Length (E <sub>L</sub> )	Terminal Box Only (E <sub>W</sub> )	Tube Pull		Length	Height	Width
					C <sub>L</sub> 1	C <sub>L</sub> 2			
CVHH (50 Hz)	950 1050	100M/100M	373.0	176.0	166.0	47.0	160.0	121.2	122.0
		100L/100L	413.5	176.0	186.0	47.0	180.3	121.2	122.0
		130M/130M	373.0	178.1	166.0	47.0	160.0	127.9	124.1
		160M/200M	373.0	180.1	166.0	47.0	160.0	135.4	126.1
		200L/220L	413.5	185.2	186.0	47.0	180.3	137.7	131.2
		220L/220L	413.5	192.1	186.0	47.0	180.3	141.6	138.1
	1550	200L/200L	413.5	181.1	186.0	47.0	180.3	137.7	127.1
		220L/220L	413.5	192.1	186.0	47.0	180.3	141.6	138.1
CVHH Heat Recovery (50 Hz)	950 1050	100M/10HM	373.0	191.8	166.0	47.0	160.0	121.2	137.8
		130M/13HM	373.0	194.0	166.0	47.0	160.0	127.9	140.0
		160M/20HM	373.0	200.7	166.0	47.0	160.0	135.4	146.7
	1550	200L/20HL	413.5	203.8	186.0	47.0	180.3	137.7	149.8
		220L/22HL	413.5	225.5	186.0	47.0	180.3	141.6	171.5
CVHH (60 Hz)	900 1000 1200	100M/100M	373.0	176.0	166.0	47.0	160.0	121.2	122.0
		100L/100L	413.5	176.0	186.0	47.0	180.3	121.2	122.0
		130M/130M	373.0	178.0	166.0	47.0	160.0	127.9	124.0
		160M/200M	373.0	180.1	166.0	47.0	160.0	135.4	126.1
		200L/220L	413.5	185.2	186.0	47.0	180.3	137.7	131.2
		220L/220L	413.5	192.1	186.0	47.0	180.3	141.6	138.1
	1500 1700	200L/200L	413.5	181.1	186.0	47.0	180.3	137.7	127.1
		220L/220L	413.5	192.1	186.0	47.0	180.3	141.6	138.1
CVHH Heat Recovery (60 Hz)	900 1000 1200	100M/10HM	373.0	191.8	166.0	47.0	160.0	121.2	137.8
		130M/13HM	373.0	194.0	166.0	47.0	160.0	127.9	140.0
		160M/20HM	373.0	200.7	166.0	47.0	160.0	135.4	146.7
	1500 1700	200L/20HL	413.5	203.8	186.0	47.0	180.3	137.7	149.8
		220L/22HL	413.5	222.0	186.0	47.0	180.3	141.6	168.0

**Notes:**

1. Dimensions do not include waterboxes, hinges, starters, or other unit-mounted options that may affect unit size. Contact your Trane representative for more information.
2. C<sub>L</sub>1 can be at either end of the machine and is required for tube pull clearance.
3. C<sub>L</sub>2 is always at the opposite end of the machine from C<sub>L</sub>1 and is required for service clearance.
4. Physical dimensions do NOT include unit-mounted starters.
5. Refer to [Figure 21](#), p. 59 for the space envelope for single compressor CenTraVac™ chillers.



## Unit Specifications – Imperial (I-P) Units

**Table 19. Physical dimensions for 50 Hz compressor chillers (in.) — CVHE and CVHG chillers**

Model	Comp Size	Shell Size	Shell Arrange	Envelope			Clearance		Base Unit Dimensions		
				Length	Width		Tube Pull				
					E <sub>L</sub>	Terminal Box Only			LV Unit Mounted Starters <sup>(a)</sup>	C <sub>L1</sub>	C <sub>L2</sub>
CVHE	190–270	032	SS	317	132	134	141	41	135.0	93.8	69.1
			SL / LL	408	132	134	186	41	180.3	93.8	69.1
		050	SS	318	135	147	141	42	135.0	98.3	80.6
			SL / LL	409	135	147	186	42	180.3	98.3	80.6
	300–420	050	SS	318	135	147	141	42	135.0	98.7	80.6
			SL / LL	409	135	147	186	42	180.3	98.7	80.6
		050/080	SS	328	144	149	141	52	135.0	103.8	90.3
			LL	419	144	149	186	52	180.3	103.8	90.3
		080	SS	328	153	158	141	52	135.0	114.9	96.9
			SL / LL	419	153	158	186	52	180.3	114.9	96.9
CVHG	480–565	050	SS	318	135	148	141	42	135.0	102.9	80.8
			SL / LL	409	135	148	186	42	180.3	102.9	80.8
		050/080	SS	328	146	152	141	52	135.0	104.7	91.4
			LL	419	146	152	186	52	180.3	104.7	91.4
		080	SS	328	155	151	141	52	135.0	115.8	97.1
			SL / LL	419	155	151	186	52	180.3	115.8	97.1
	670–780	080	SS	328	153	159	141	52	135.0	114.9	97.1
			SL / LL	419	153	159	186	52	180.3	114.9	97.1
		080/142	LL	426	175	175	186	59	180.3	117.8	120.9
		142	ML / LL	426	174	170	186	59	180.3	121.3	115.5
	920–1067	080/142	LL	426	177	176	186	59	180.3	119.2	121.8
		142	ML / LL	426	174	170	186	59	180.3	121.1	115.4
		142/210	ML / LL	426	185	181	186	59	180.3	126.6	126.8
			EL	471	185	181	209	59	202.8	126.6	126.8
		210	LL	426	182	179	186	59	180.3	132.8	124.6
	1100	080/142	LL	426	177	176	186	59	180.3	121.6	121.8
		142	ML / LL	426	177	173	186	59	180.3	121.5	118.3
		210	LL	426	182	179	186	59	180.3	135.2	124.6

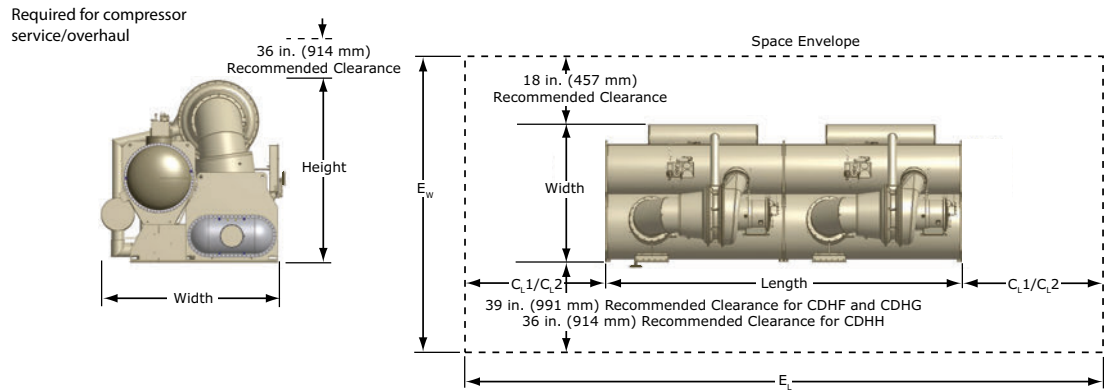
**Notes:**

1. C<sub>L1</sub> can be at either end of the machine and is required for tube pull clearance.
2. C<sub>L2</sub> is always at the opposite end of the machine from C<sub>L1</sub> and is required for service clearance.
3. DMP = Differential Motor Protection
4. SMP = Supplemental Motor Protection, no unit-mounted starter
5. CPTR = Control Power Transformer option, no unit-mounted starter
6. Refer to [Figure 21, p. 59](#) for the space envelope for single compressor CenTraVac™ chillers.

<sup>(a)</sup> Dimensions for low-voltage unit-mounted starters. Medium-voltage starters are also available for unit mounting.

## Dual Compressor Chillers

**Figure 22. Space envelope for 60 and 50 Hz dual compressor chillers — CDHF, CDHG, and CDHH chillers (CDHF unit shown)**



**Note:** Physical dimensions without unit-mounted starters. Refer to the following tables for I-P data for dual compressor CenTraVac™ chillers; refer to “Dual Compressor Chillers,” p. 85 for SI data for dual compressor CenTraVac™ chillers.

**Table 20. Chiller water connection pipe sizes (in.) — CDHF and CDHG chillers**

Water Passes	Shell Size			
	210D	250D	250M	250X
Evaporator	Nominal Pipe Size			
1 Pass	16	16	18	18
Condenser	Nominal Pipe Size			
1 Pass	16	16	20	20

**Table 21. Chiller water connection pipe sizes (in.) — CDHH chillers**

Water Passes	Shell Size	
	400	440
Evaporator	Nominal Pipe Size	
1 Pass	16	20
2 Pass	—	—
3 Pass	—	—
Condenser	Nominal Pipe Size	
1 Pass	—	24
2 Pass	—	—



## Unit Specifications – Imperial (I-P) Units

**Table 22. Physical dimensions dual 60 and 50 Hz compressor units (in.) — CDHF and CDHG chillers**

Model	Comp Size	Shell Size	Shell Arrange	Envelope				Clearance		Base Unit Dimensions		
				Length	Width			Tube Pull				
					Terminal Box Only	MV Unit Mounted Starters	LV Unit Mounted AFD			C <sub>L1</sub>	C <sub>L2</sub>	Length
E <sub>L</sub>	E <sub>W</sub>	E <sub>W</sub>	E <sub>W</sub>	C <sub>L1</sub>	C <sub>L2</sub>	Length	Height	Width				
CDHF	1500	210	DD	606	183	203	208	264	84	258	133.0	125.0
	2000											
	2170	250	DD	606	194	207	215	264	84	258	139.3	136.8
	2550											
	3000											
3500												
CDHG	1250	210	DD	606	185	205	N/A	264	84	258	133.0	124.9
	1750											
	2250	210	DD	606	184	204	N/A	264	84	258	135.2	124.9

**Notes:**

1. C<sub>L1</sub> can be at either end of the machine and is required for tube pull clearance.
2. C<sub>L2</sub> is always at the opposite end of the machine from C<sub>L1</sub> and is required for service clearance.
3. Refer to Figure 22, p. 63 for the space envelope for dual compressor CenTraVac™ chillers.

**Table 23. Physical dimensions for 60 and 50 Hz dual compressor chillers (in.) — CDHH chillers**

Units	Comp Size	Shell Configuration EVAP/COND	Space Envelope		Clearance		Base Unit Dimensions		
			Length (E <sub>L</sub> )	Terminal Box Only (E <sub>W</sub> )	Tube Pull		Length	Height	Width
					C <sub>L1</sub>	C <sub>L2</sub>			
CDHH (50 Hz)	1750	400M/440M	698.0	185.2	318.0	68.0	312.0	137.7	131.2
	2250								
	3050	440M/440M	706.0	192.1	318.0	76.0	312.0	141.6	138.1
		440X/440X	802.0	192.1	366.0	76.0	360.0	141.6	138.1
		440M/44HM	706.0	192.1	318.0	76.0	312.0	141.6	138.1
CDHH (60 Hz)	2000	400M/440M	698.0	185.2	318.0	68.0	312.0	137.7	131.2
	2600								
	2800	440M/440M	706.0	192.1	318.0	76.0	312.0	141.6	138.1
	3300	440X/440X	802.0	192.1	366.0	76.0	360.0	141.6	138.1
	2800	440M/44HM	706.0	192.1	318.0	76.0	312.0	141.6	138.1
	3300	440X/44HX	802.0	192.1	366.0	76.0	360.0	141.6	138.1

**Notes:**

1. Dimensions do not include waterboxes, hinges, starters, or other unit-mounted options that may affect unit size. Contact your Trane representative for more information.
2. C<sub>L1</sub> can be at either end of the machine and is required for tube pull clearance.
3. C<sub>L2</sub> is always at the opposite end of the machine from C<sub>L1</sub> and is required for service clearance.
4. Refer to Figure 22, p. 63 for the space envelope for dual compressor CenTraVac™ chillers.



## Waterbox Lengths

Table 24. 150 psig waterbox lengths (in.) — CDHF, CDHG, CVHE, CVHF, and CVHG chillers

Shell	Passes	Evaporator		Condenser	
		Supply Length	Return Length	Supply Length	Return Length
<b>Non-Marine Waterboxes</b>					
320	1	12.8	—	13.0	—
	2	12.8	6.8	9.3	6.1
	3	12.8	—	—	—
500	1	12.7	—	14.7	—
	2	12.7	7.4	23.6	8.0
	3	12.7	—	—	—
800	1	13.2	—	15.9	—
	2	13.2	7.3	14.1	8.8
	3	13.2	—	—	—
1420	1	14.6	—	19.0	—
	2	14.6	8.4	17.5	13.6
	3	14.6	—	—	—
2100	1	16.0	—	19.5	—
	2	16.0	9.6	17.9	14.1
	3	16.0	—	—	—
2500	1	18.9	—	20.5	—
	2	18.9	10.4	19.3	15.1
	3	18.9	—	—	—
2100 (Duplex™)	1	16.0	—	19.5	—
2500 (Duplex™)	1	18.9	—	20.5	—
<b>Marine Waterboxes</b>					
320	1	15.9	—	17.1	—
	2	15.9	6.8	16.8	6.1
	3	15.9	—	—	—
500	1	18.3	—	21.3	—
	2	18.3	7.4	15.9	8.0
	3	18.3	—	—	—
800	1	23.2	—	22.9	—
	2	23.2	7.3	23.3	8.8
	3	23.2	—	—	—
1420	1	27.9	—	39.5	—
	2	27.9	8.4	37.5	13.6
	3	27.9	—	—	—
2100	1	28.4	—	40.5	—
	2	28.4	9.6	38.3	14.1
	3	28.4	—	—	—
2500	1	30.2	—	45.0	—
	2	30.2	10.4	41.0	15.1
	3	—	—	—	—



## Unit Specifications – Imperial (I-P) Units

**Table 24. 150 psig waterbox lengths (in.) — CDHF, CDHG, CVHE, CVHF, and CVHG chillers (continued)**

Shell	Passes	Evaporator		Condenser	
		Supply Length	Return Length	Supply Length	Return Length
2100 (Duplex™)	1	28.4	—	40.5	—
2500 (Duplex™)	1	30.2	—	45.0	—

**Table 25. 300 psig waterbox lengths (in.) — CDHF, CDHG, CVHE, CVHF, and CVHG chillers**

Shell	Passes	Evaporator		Condenser	
		Supply Length	Return Length	Supply Length	Return Length
<b>Non-Marine Waterboxes</b>					
320	1	12.8	—	13.3	—
	2	12.8	6.8	20.1	7.6
	3	12.8	—	—	—
500	1	12.7	—	15.5	—
	2	12.7	6.7	24.4	10.4
	3	12.7	—	—	—
800	1	13.8	—	15.8	—
	2	13.8	7.8	24.7	10.6
	3	13.8	—	—	—
1420	1	15.2	—	21.1	—
	2	15.2	9.5	19.6	15.9
	3	15.2	—	—	—
2100	1	—	—	22.1	—
	2	—	9.8	20.5	15.7
	3	—	—	—	—
2500	1	21.2	—	24.6	—
	2	21.2	13.2	21.9	17.3
	3	21.2	—	—	—
2100 (Duplex™)	1	—	—	22.1	—
2500 (Duplex™)	1	21.2	—	24.6	—
<b>Marine Waterboxes</b>					
300	1	18.9	—	23.6	—
	2	18.9	6.7	18.2	8.2
	3	—	—	—	—
320	1	15.9	—	17.2	—
	2	15.9	6.8	17.0	7.6
	3	15.9	—	—	—
500	1	18.9	—	23.6	—
	2	18.9	6.7	18.2	8.2
	3	18.9	—	—	—
800	1	25.3	—	28.5	—
	2	25.3	7.1	28.0	8.6
	3	25.3	—	—	—

**Table 25. 300 psig waterbox lengths (in.) — CDHF, CDHG, CVHE, CVHF, and CVHG chillers (continued)**

Shell	Passes	Evaporator		Condenser	
		Supply Length	Return Length	Supply Length	Return Length
1420	1	29.9	—	35.0	—
	2	29.9	8.8	33.0	9.7
	3	29.9	—	—	—
2100	1	31.7	—	38.7	—
	2	31.7	9.8	34.9	13.7
	3	31.7	—	—	—
2500	1	33.9	—	38.2	—
	2	—	—	38.2	14.7
	3	—	—	—	—
2100 (Duplex™)	1	31.7	—	38.7	—
2500 (Duplex™)	1	33.9	—	38.2	—

**Table 26. 150 psig waterbox lengths (in.) — CDHH and CVHH chillers**

Shell	Passes	Evaporator		Condenser	
		Supply Length	Return Length	Supply Length	Return Length
<b>Non-Marine Waterboxes</b>					
100M/L	1	20.3	20.3	18.5	18.5
	2	21.9	13.8	20.4	11.9
100M/L	3	19.3	19.3	—	—
130M	1	21.4	21.4	21.5	21.5
	2	23.1	14.8	21.4	13.4
	3	20.4	20.4	—	—
160M	1	23.3	23.3	—	—
	2	23.3	15.3	—	—
	3	22.6	22.6	—	—
200M/L	1	17.3	17.3	21.1	21.1
	2	16.9	9.6	21.2	14.1
	3	16.3	16.3	—	—
220L	1	18.3	18.3	22.0	22.0
	2	17.6	10.4	22.2	15.1
	3	17.5	17.5	—	—
400M	1	17.3	23.3	21.1	21.1
440M/X	1	18.3	18.3	22.0	22.0
44HM/HX	1	18.3	18.3	22.0	22.0
10HM	1	—	—	17.1	17.1
	2	—	—	20.5	8.7
13HM	1	—	—	17.1	17.1
	2	—	—	20.5	8.7
20HM/L	1	—	—	20.1	20.1
	2	—	—	20.4	8.7
22HM/L	1	—	—	17.4	17.4
	2	—	—	20.4	8.7



## Unit Specifications – Imperial (I-P) Units

**Table 26. 150 psig waterbox lengths (in.) — CDHH and CVHH chillers (continued)**

Shell	Passes	Evaporator		Condenser	
		Supply Length	Return Length	Supply Length	Return Length
<b>Marine Waterboxes</b>					
100M/L	1	40.1	40.1	37.3	37.3
	2	40.1	13.8	37.3	11.9
	3	40.1	40.1	—	—
130M	1	41.1	41.1	38.8	38.8
	2	41.1	14.8	38.8	13.4
	3	41.1	41.1	—	—
160M	1	47.5	47.5	—	—
	2	46.3	15.3	—	—
	3	46.3	46.3	—	—
200M/L	1	34.8	34.8	43.7	43.7
	2	34.8	9.6	41.2	14.1
	3	34.8	31.6	—	—
220L	1	39.1	39.1	52.0	52.0
	2	39.1	10.4	41.5	15.1
	3	—	—	—	—
400M	1	34.8	34.8	—	—
440M/X	1	39.1	39.1	52.0	52.0
44HM/HX	2	—	—	20.4	8.7

**Table 27. 300 psig waterbox lengths (in.) — CDHH and CVHH chillers**

Shell	Passes	Evaporator		Condenser	
		Supply Length	Return Length	Supply Length	Return Length
<b>Non-Marine Waterboxes</b>					
100M/L	1	—	—	20.0	20.0
	2	—	8.3	20.4	12.4
	3	—	—	—	—
130M	1	—	—	21.9	21.9
	2	—	8.3	22.4	14.0
	3	—	—	—	—
160M	1	—	—	—	—
	2	—	8.4	—	—
	3	—	—	—	—

**Table 27. 300 psig waterbox lengths (in.) — CDHH and CVHH chillers (continued)**

Shell	Passes	Evaporator		Condenser	
		Supply Length	Return Length	Supply Length	Return Length
200M/L	1	—	—	22.2	22.2
	2	—	9.8	22.2	12.5
	3	—	—	—	—
220L	1	21.2	21.2	24.9	24.9
	2	21.2	13.1	23.6	14.7
	3	21.2	21.2	—	—
400M	1	—	—	22.2	22.2
440M/X	1	21.2	21.2	24.9	24.9
<b>Marine Waterboxes</b>					
100M/L	1	28.0	28.0	37.9	37.9
	2	28.0	8.3	35.9	12.4
	3	28.0	23.9	—	—
130M	1	28.0	28.0	40.7	40.7
	2	28.0	8.3	39.0	14.0
	3	28.0	23.9	—	—
160M	1	29.2	29.2	—	—
	2	29.2	8.4	—	—
	3	29.2	26.1	—	—
200M/L	1	38.7	38.7	39.1	39.1
	2	38.7	9.8	36.4	12.5
	3	38.7	35.5	—	—
220L	1	45.3	45.3	54.4	54.4
	2	45.3	13.3	43.8	14.7
	3	—	—	—	—
400M	1	38.7	38.7	—	—
440M/X	1	45.3	45.3	54.4	54.4



# Unit Specifications – International System (SI) Units

## Performance Data

Table 28. Minimum and maximum evaporator flow rates (L/s) — CDHF, CDHG, CVHE, CVHF, and CVHG chillers

Shell Size EVSZ	Bundle Size EVBS	One Pass						Two Pass						Three Pass					
		IECU/IMCU		IMC1		TECU		IECU/IMCU		IMC1		TECU		IECU/IMCU		IMC1		TECU	
		Min	Max	Min	Max	Min	Max	Min	Max	Min	Max	Min	Max	Min	Max	Min	Max	Min	Max
032S	200	10	72	—	—	15	84	5	36	—	—	8	42	3	24	—	—	5	28
	230	11	83	—	—	17	94	6	41	—	—	9	47	4	28	—	—	6	31
	250	12	88	—	—	19	103	6	44	—	—	9	52	4	29	—	—	6	34
032S/L	280	14	101	14	101	21	118	7	50	7	51	11	59	5	34	5	34	7	39
	320	15	114	16	115	24	132	8	57	8	57	12	66	5	38	5	38	8	44
	350	17	125	17	126	—	—	8	63	9	63	—	—	6	42	6	42	—	—
050S/L	390	20	143	—	—	30	164	10	72	—	—	15	82	7	48	—	—	10	55
	480	23	171	—	—	36	201	12	85	—	—	18	100	8	57	—	—	12	67
	580	28	207	—	—	44	240	14	103	—	—	22	120	9	69	—	—	15	80
	700	34	251	34	252	51	282	17	125	17	126	26	141	11	84	11	84	17	94
	860	41	303	42	305	—	—	21	152	21	152	—	—	14	101	14	102	—	—
080S/L	740	37	270	37	271	—	—	18	135	19	136	—	—	12	90	12	90	—	—
	880	43	317	—	—	60	106	22	159	—	—	30	166	14	106	—	—	20	111
	1050	53	389	—	—	69	381	27	194	—	—	35	190	18	130	—	—	23	127
	1210	62	452	—	—	77	426	31	226	—	—	39	213	21	151	—	—	26	142
	1400	72	530	73	532	89	490	36	265	36	266	45	245	24	177	24	177	30	163
142M/L	960	47	348	48	352	—	—	24	174	24	176	—	—	16	116	16	117	—	—
	1200	57	416	57	421	58	426	28	208	29	211	29	213	19	139	19	140	19	142
	1320	67	490	68	496	65	480	33	245	34	248	33	240	22	163	23	165	22	160
	1600	75	553	76	560	73	535	38	277	38	280	36	267	25	184	25	187	24	178
	1750	85	625	86	632	82	605	42	312	43	316	41	302	28	208	29	211	27	202
	1890	92	677	93	684	89	651	46	338	47	342	44	326	31	226	31	228	30	217
142E	960	47	350	48	352	—	—	24	175	24	176	—	—	16	117	16	117	—	—
	1200	57	419	57	421	58	426	28	210	29	211	29	213	19	140	19	140	19	142
	1320	67	494	68	496	65	480	33	247	34	248	33	240	22	165	23	165	22	160
	1600	75	557	76	560	73	535	38	279	38	280	36	267	25	186	25	187	24	178
	1750	85	629	86	632	82	605	43	314	43	316	41	302	28	210	29	211	27	202
	1890	92	681	93	684	89	651	46	341	47	342	44	326	31	227	31	228	30	217
210L	1610	78	569	79	576	93	510	39	284	39	288	46	255	26	190	26	192	31	170
	1760	87	638	88	647	104	570	44	319	44	323	52	285	29	213	29	216	35	190
	1900	96	705	97	715	115	633	48	353	49	357	58	316	32	235	32	238	38	211
	2100	102	749	104	759	127	697	51	374	52	380	63	349	34	250	35	253	42	232
250E	2280	102	747	—	—	126	695	51	374	—	—	63	347	—	—	—	—	—	—
	2300	111	815	—	—	137	754	56	407	—	—	69	377	37	272	—	—	46	251
	2480	113	827	—	—	139	764	56	414	—	—	69	382	—	—	—	—	—	—
	2500	122	892	—	—	151	830	61	446	—	—	75	415	41	297	—	—	50	277

## Unit Specifications – International System (SI) Units

**Table 28. Minimum and maximum evaporator flow rates (L/s) — CDHF, CDHG, CVHE, CVHF, and CVHG chillers (continued)**

Shell Size EVSZ	Bundle Size EVBS	One Pass						Two Pass						Three Pass					
		IECU/IMCU		IMC1		TECU		IECU/IMCU		IMC1		TECU		IECU/IMCU		IMC1		TECU	
		Min	Max	Min	Max	Min	Max	Min	Max	Min	Max	Min	Max	Min	Max	Min	Max	Min	Max
210D	1610	77	566	—	—	90	493	—	—	—	—	—	—	—	—	—	—	—	—
	1850	88	646	—	—	106	583	—	—	—	—	—	—	—	—	—	—	—	—
	2100	99	725	—	—	122	671	—	—	—	—	—	—	—	—	—	—	—	—
250D/M/X	2100	99	725	—	—	123	674	—	—	—	—	—	—	—	—	—	—	—	—
	2300	109	802	—	—	133	729	—	—	—	—	—	—	—	—	—	—	—	—
	2500	120	878	—	—	146	803	—	—	—	—	—	—	—	—	—	—	—	—

**Note:** The minimum evaporator water velocity is 0.457 m/s for IECU tubes and 0.610 m/s for all other tubes. For a variable evaporator water flow system, the minimum GPME is generally not applicable at full load, and may be limited by other factors such as glycol. Confirm actual minimum and maximum flows for each selection before operating near flow boundaries. Values in this table are based on 0.64-mm wall tubes for M, L, S, and E bundles and 0.71-mm wall tubes for D, M, and X bundles.

**Table 29. Minimum and maximum evaporator flow rates, L/s — CDHH and CVHH chillers**

Shell Size (EVSZ)	Bundle Size (EVBS)	Tube Type																			
		IECU						IMC1						TECU						IMCU	
		Number of Passes																			
		1		2		3		1		2		3		1		2		3		1	
Min	Max	Min	Max	Min	Max	Min	Max	Min	Max	Min	Max	Min	Max	Min	Max	Min	Max	Min	Max		
100M	810	48	353	25	171	17	115	48	352	25	170	17	115	45	331	23	162	16	107	—	—
	870	51	375	26	182	18	122	51	374	26	181	18	122	48	348	24	170	17	113	—	—
	1000	61	450	32	218	21	149	61	449	32	217	21	148	54	398	28	194	19	130	—	—
100L	810	48	353	25	171	17	115	48	352	25	170	17	115	45	331	23	162	16	107	—	—
	870	51	375	26	182	18	122	51	374	26	181	18	122	48	348	24	170	17	113	—	—
	1000	61	450	32	218	21	149	61	449	32	217	21	148	54	398	28	194	19	130	—	—
130M	1040	62	451	32	219	21	146	61	450	32	219	21	145	55	406	28	199	19	131	—	—
	1140	68	497	35	242	23	161	68	496	35	241	23	161	60	440	31	216	20	142	—	—
	1300	75	551	39	268	26	168	75	550	39	267	26	168	65	475	33	232	22	148	—	—
160M	1290	76	561	38	280	26	186	76	560	38	280	25	186	67	491	34	241	22	163	—	—
	1390	85	620	42	310	28	207	84	619	42	309	28	206	72	531	36	266	24	177	—	—
	1600	96	704	48	351	32	235	96	702	48	350	32	234	81	592	40	296	27	197	—	—
200L	1520	82	600	43	286	—	—	82	598	43	285	—	—	74	539	38	259	26	167	—	—
	1680	92	673	47	329	32	210	92	672	47	328	32	209	82	601	42	290	29	191	—	—
	1840	100	736	53	350	35	221	100	734	53	349	35	220	90	660	47	319	33	208	—	—
	2000	108	788	58	365	40	232	107	787	58	364	39	231	96	705	54	312	37	218	—	—
220L	1850	114	837	57	418	38	279	114	835	57	418	38	278	99	725	49	363	33	242	—	—
	2000	126	924	63	462	42	308	126	922	63	461	42	307	109	796	54	398	36	265	—	—
	2200	143	1049	72	525	48	350	143	1047	71	524	48	349	125	913	62	457	42	304	—	—
400M	3040	82	600	—	—	—	—	—	—	—	—	—	—	76	554	—	—	—	—	81	596
	3360	92	673	—	—	—	—	—	—	—	—	—	—	84	618	—	—	—	—	91	669
	3680	100	736	—	—	—	—	—	—	—	—	—	—	93	679	—	—	—	—	100	731
	4000	108	788	—	—	—	—	—	—	—	—	—	—	99	725	—	—	—	—	107	783



## Unit Specifications – International System (SI) Units

**Table 29. Minimum and maximum evaporator flow rates, L/s — CDHH and CVHH chillers (continued)**

Shell Size (EVSZ)	Bundle Size (EVBS)	Tube Type																			
		IECU						IMC1						TECU						IMCU	
		Number of Passes																			
		1		2		3		1		2		3		1		2		3		1	
Min	Max	Min	Max	Min	Max	Min	Max	Min	Max	Min	Max	Min	Max	Min	Max	Min	Max	Min	Max		
440M	3700	114	837	—	—	—	—	—	—	—	—	—	—	102	745	—	—	—	—	113	831
	4000	126	924	—	—	—	—	—	—	—	—	—	—	112	818	—	—	—	—	125	918
	4400	143	1049	—	—	—	—	—	—	—	—	—	—	128	939	—	—	—	—	142	1042
44HM	3700	114	837	—	—	—	—	—	—	—	—	—	—	102	745	—	—	—	—	113	831
	4000	126	924	—	—	—	—	—	—	—	—	—	—	112	818	—	—	—	—	125	918
	4400	143	1049	—	—	—	—	—	—	—	—	—	—	128	939	—	—	—	—	142	1042
440X	3700	114	837	—	—	—	—	—	—	—	—	—	—	102	745	—	—	—	—	113	831
	4000	126	924	—	—	—	—	—	—	—	—	—	—	112	818	—	—	—	—	125	918
	4400	143	1049	—	—	—	—	—	—	—	—	—	—	128	939	—	—	—	—	142	1042
44HX	3700	114	837	—	—	—	—	—	—	—	—	—	—	102	745	—	—	—	—	113	831
	4000	126	924	—	—	—	—	—	—	—	—	—	—	112	818	—	—	—	—	125	918
	4400	143	1049	—	—	—	—	—	—	—	—	—	—	128	939	—	—	—	—	142	1042

**Table 30. Minimum and maximum condenser flow rates (L/s) — CDHF, CDHG, CVHE, CVHF, and CVHG chillers**

Shell Size CDSZ	Bundle Size CDBS	One Pass						Two Pass					
		IMCU		TECU		IECU		IMCU		TECU		IECU	
		Min	Max	Min	Max	Min	Max	Min	Max	Min	Max	Min	Max
032S	230	27	100	26	96	27	100	14	50	13	48	14	50
032S/L	250	31	113	29	108	31	113	15	56	15	54	15	57
	280	34	125	33	121	34	126	17	63	16	60	17	63
	320	38	140	36	134	38	141	19	70	18	67	19	71
050S	360	43	159	41	152	44	160	22	80	21	76	22	80
050S/L	400	49	180	47	171	49	180	24	90	23	86	25	90
	450	55	202	52	193	55	203	28	101	26	96	28	102
	500	61	225	51	113	62	226	31	113	31	113	31	113
080S	500	61	225	58	213	62	226	31	113	29	107	31	113
	560	69	252	65	238	69	253	34	126	33	119	34	126
080S/L	630	77	282	73	269	77	283	38	141	37	135	39	142
	710	86	316	83	304	87	318	43	158	41	152	43	159
	800	97	355	93	341	97	357	48	178	47	171	49	179
142L	890	110	402	105	386	110	404	55	201	53	193	55	202
	980	122	448	117	429	123	450	61	224	58	214	61	225
	1080	137	501	131	479	137	503	68	250	65	240	69	252
	1220	152	559	146	536	153	562	76	280	73	268	77	281
	1420	176	646	165	604	177	649	88	323	82	302	89	325
210L	1610	187	687	164	602	188	690	94	343	82	301	94	345
	1760	207	760	182	666	208	764	104	380	91	333	104	382
	1900	227	832	199	730	228	836	114	416	100	365	114	418
	2100	246	902	217	796	247	906	123	451	109	398	124	453



## Unit Specifications – International System (SI) Units

**Table 30. Minimum and maximum condenser flow rates (L/s) — CDHF, CDHG, CVHE, CVHF, and CVHG chillers (continued)**

Shell Size CDSZ	Bundle Size CDBS	One Pass						Two Pass					
		IMCU		TECU		IECU		IMCU		TECU		IECU	
		Min	Max	Min	Max	Min	Max	Min	Max	Min	Max	Min	Max
250L	2100	246	901	217	796	247	905	123	450	109	398	123	452
	2300	270	989	239	875	271	994	135	495	119	437	136	497
	2500	294	1077	261	956	295	1082	147	538	130	478	147	541
210D	1610	187	687	164	602	188	690	—	—	—	—	—	—
	1760	207	760	182	666	90	764	—	—	—	—	—	—
	1900	227	832	199	730	106	836	—	—	—	—	—	—
	2100	246	902	217	796	247	906	—	—	—	—	—	—
250D/M/X	2100	246	901	217	796	247	905	—	—	—	—	—	—
	2300	270	989	239	875	271	994	—	—	—	—	—	—
	2500	294	1077	261	956	295	1082	—	—	—	—	—	—

**Note:** The minimum condenser water velocity is 0.914 m/s and the maximum is 3.35 m/s, and may be limited by other factors such as glycol. Confirm actual minimum and maximum flows for each selection before operating near flow boundaries. Values in this table are based on 0.71-mm wall tubes.

**Table 31. Minimum and maximum condenser flow rates (L/s) — CDHH and CVHH chillers**

Shell Size (CDSZ)	Bundle Size (CDBS)	Tube Type											
		IECU				IMCU				TECU			
		Number of Passes											
		1		2		1		2		1		2	
		Min	Max	Min	Max	Min	Max	Min	Max	Min	Max	Min	Max
100M	810	131	481	66	240	133	489	67	244	117	429	58	214
	870	145	530	72	265	147	539	73	269	128	471	64	235
	1000	155	569	78	285	158	579	79	289	138	507	69	254
100L	810	131	481	66	240	133	489	67	244	117	429	58	214
	870	145	530	72	265	147	539	73	269	128	471	64	235
	1000	155	569	78	285	158	579	79	289	138	507	69	254
10HM	810	132	483	66	242	134	491	67	246	117	429	58	214
	870	144	529	72	264	147	537	73	269	128	471	64	235
	1000	155	568	77	284	157	577	79	289	140	514	70	257
130M	1040	164	600	82	300	166	609	83	305	146	535	73	268
	1140	179	658	90	329	182	669	91	334	160	588	80	294
	1300	195	714	97	357	198	725	99	363	173	635	87	318
13HM	1040	164	600	82	300	166	609	83	305	146	535	73	268
	1140	179	658	90	329	182	669	91	334	160	588	80	294
	1300	195	714	97	357	198	725	99	363	173	635	87	318
200M	1520	186	683	93	342	189	694	95	347	164	600	82	300
	1680	207	759	104	380	210	771	105	386	181	663	90	331
	1840	228	835	114	417	231	849	116	424	198	727	99	363
	2000	246	902	123	451	250	917	125	458	216	791	108	396



## Unit Specifications – International System (SI) Units

**Table 31. Minimum and maximum condenser flow rates (L/s) — CDHH and CVHH chillers (continued)**

Shell Size (CDSZ)	Bundle Size (CDBS)	Tube Type											
		IECU				IMCU				TECU			
		Number of Passes											
		1		2		1		2		1		2	
Min	Max	Min	Max	Min	Max	Min	Max	Min	Max	Min	Max	Min	Max
200L	1520	186	683	93	342	189	694	95	347	164	600	82	300
	1680	207	759	104	380	210	771	105	386	181	663	90	331
	1840	228	835	114	417	231	849	116	424	198	727	99	363
	2000	245	898	122	449	249	913	124	456	216	791	108	396
20HM	1520	186	683	93	342	189	694	95	347	164	600	82	300
	1680	207	759	104	380	210	771	105	386	180	661	90	331
	1840	228	835	114	417	231	849	116	424	198	727	99	363
	2000	237	870	119	435	241	885	121	442	207	759	104	380
220L	1850	246	902	123	451	250	917	125	458	216	791	108	396
	2000	270	991	135	495	275	1007	137	503	237	869	118	434
	2200	292	1072	146	536	297	1089	148	544	259	951	130	475
22HL	1850	246	901	123	450	250	915	125	458	216	791	108	396
	2000	270	992	135	496	275	1008	137	504	237	869	118	434
	2200	292	1070	146	535	297	1088	148	544	259	951	130	476
440M	3700	246	902	—	—	250	917	—	—	216	791	—	—
	4000	270	991	—	—	275	1007	—	—	237	869	—	—
	4400	292	1072	—	—	297	1089	—	—	259	951	—	—
44HM	3700	246	902	—	—	250	917	—	—	216	791	—	—
	4000	270	991	—	—	275	1007	—	—	237	869	—	—
	4400	292	1072	—	—	297	1089	—	—	259	951	—	—
440X	3700	246	902	—	—	250	917	—	—	216	791	—	—
	4000	270	991	—	—	275	1007	—	—	237	869	—	—
	4400	292	1072	—	—	297	1089	—	—	259	951	—	—
44HX	3700	246	902	—	—	250	917	—	—	216	791	—	—
	4000	270	991	—	—	275	1007	—	—	237	869	—	—
	4400	292	1072	—	—	297	1089	—	—	259	951	—	—

## Weights (kg)

**Important:** The weight information provided here should be used for general information only. Trane does not recommend using this weight information for considerations relative to chiller handling, rigging, or placement. The large number of variances between chiller selections drives variances in chiller weights that are not recognized in these tables. For specific weights for your chiller, refer to your submittal package.

## Unit Specifications – International System (SI) Units

**Table 32. Representative weights, 60 Hz chillers (kg) — CVHE, CVHF, and CDHF chillers**

Model	Comp Size	CPKW	Evap Size	Cond Size	Weights without Starters		Weights with Starters	
	NTON		EVSZ	CDSZ	Operating	Shipping	Operating	Shipping
CVHE	230–320	233	032S	032S	6726	6109	—	—
		289			—	—	7488	6871
	230–320	289	032S	032L	7000	6316	7762	7078
	230–320	289	032L	032L	7383	6611	8145	7373
	230–320	289	050S	050S	9088	7983	9850	8745
	230–320	289	050S	050L	9526	8326	10288	9088
	230–320	289	050L	050L	10139	8756	10901	9518
	360–500	455	050S	050S	9397	8292	10159	9054
	360–500	455	050S	050L	9835	8635	10597	9398
	360–500	455	050L	050L	10448	9065	11210	9828
	360–500	455	050S	080S	10523	9192	11285	9954
	360–500	455	050L	080L	12153	10422	12915	11184
	360–500	455	080S	080S	13542	11627	14304	12389
	360–500	455	080S	080L	14262	12209	15024	12971
	360–500	455	080L	080L	15179	12852	15941	13614



## Unit Specifications – International System (SI) Units

**Table 32. Representative weights, 60 Hz chillers (kg) — CVHE, CVHF, and CDHF chillers (continued)**

Model	Comp Size	CPKW	Evap Size	Cond Size	Weights without Starters		Weights with Starters	
	NTON		EVSZ	CDSZ	Operating	Shipping	Operating	Shipping
CVHF	350–570	588	050S	050S	9293	8157	10055	8919
	350–570	588	050S	050L	9731	8501	10493	9263
	350–570	588	050L	050L	10298	8875	11060	9637
	350–570	588	050S	080S	10419	9057	11181	9819
	350–570	588	050L	080L	12026	10232	12788	10994
	350–570	588	080S	080S	14445	12246	14593	12571
	350–570	588	080S	080L	14574	12391	15336	13153
	350–570	588	080L	080L	15567	13088	16329	13850
	350–910	957	080S	080S	14897	12875	16258	14236
	350–910	957	080S	080L	15640	13457	17001	14818
	350–910	957	080L	080L	16633	14154	17994	15515
	350–910	957	080L	142L	20327	17084	21688	18444
	350–910	957	142M	142L	21975	18389	23336	19749
	350–910	957	142L	142L	22529	18803	23889	20164
	1070–1300	1062	080L	142L	20734	17490	22094	18851
	1070–1300	1062	142M	142L	22279	18693	23639	20053
	1070–1300	1062	142L	142L	22832	19107	24193	20467
	1070–1300	1062	142E	142L	23479	19554	24840	20915
	1070–1300	1062	142M	210L	24976	20891	26336	22252
	1070–1300	1062	142L	210L	25552	21305	26913	22666
	1070–1300	1062	142E	210L	26199	21752	27559	23113
	1070–1300	1062	210L	210L	28077	23555	29438	24915
	1070–1300	1062	250E	250L	34542	28726	35903	30087
	1470	1340	210L	210L	29279	24757	30640	26118
1470–1720	1340	142L	210L	26755	22508	28115	23868	
1470–1720	1340	250E	250L	35744	29928	37105	31289	
CDHF	1500–2000	745	210D	210D	43236	36319	45958	39040
	2170–2550	1062	250D	250D	50043	41461	52764	44182
	3000	1062	250M	250M	57012	47024	59734	49745
	3500	957	250X	250X	—	—	60707	49580
		1229			62927	51800	—	—

**Notes:**

1. TECU tubes, 0.71 mm tube wall thickness.
2. 2068.4 kPaG non-marine waterboxes.
3. Heaviest possible bundle and motor combination.
4. Operating weights assume the largest possible refrigerant charge.
5. Weights with starters assume the heaviest possible starter (AFD when it's an allowed option).
6. Industrial Control Panel (INDP) option, add 23 kg.
7. Control Power Transformer (CPTR) option, add 59 kg.
8. Supplemental Motor Protection (SMP) option, add 227 kg.

## Unit Specifications – International System (SI) Units

**Table 33. Representative weights, 60 Hz chillers (kg)**

Model	Comp Size	CPKW	Evap Size	Cond Size	Weights without Starters	
	NTON		EVSZ	CDSZ	Operating	Shipping
CVHH	900–1200	1228	100M	100M	21523	18629
	900–1200	1228	100L	100L	22340	19218
	900–1200	1340	100M	10HM	24947	21681
	900–1200	1340	130M	130M	23981	20364
	900–1200	1340	130M	13HM	28206	24221
	900–1200	1340	160M	200M	28873	24322
	900–1200	1340	200L	220L	32642	26731
	900–1200	1340	220L	220L	35871	29331
	1500–1700	1340	200L	200L	32169	26824
	1500–1700	1340	200L	20HL	36406	30646
	1500–1700	1340	220L	220L	35871	29331
	1500–1700	1340	220L	22HL	42364	35407
CDHH	2000–2600	1340	400M	440M	56437	45781
	2800–3300	1340	440M	440M	60907	49124
	2800–3300	1340	440X	440X	64235	51446
	2000–2600	1340	440M	44HM	72440	55322
	2800–3300	1340	440X	44HX	77906	58634

**Notes:**

1. TECU tubes, 0.71 mm tube wall thickness.
2. 2068.4 kPaG marine waterboxes.
3. Heaviest possible bundle and motor combination.
4. Operating weights assume the largest possible refrigerant charge.
5. Industrial Control Panel (INDP) option, add 23 kg.
6. Control Power Transformer (CPTR) option, add 127 kg.
7. Supplemental Motor Protection (SMP) option, add 227 kg.
8. To calculate the maximum chiller weight with starter/drive, add the starter/AFD weight from the following table (maximum weights, unit-mounted starters/AFDs [kg]) to the chiller maximum weight from this table. Note that Duplex™ chiller models CDHH will have two starters, one for each compressor.



## Unit Specifications – International System (SI) Units

**Table 34. Weights, 50 Hz chillers (kg) — CVHE, CVHG, and CDHG chillers**

Model	Comp Size	CPKW	Evap Size	Cond Size	Weights without Starters		Weights with Starters	
	NTON		EVSZ	CDSZ	Operating	Shipping	Operating	Shipping
CVHE	190–320	215	032S	032S	6706	6090	—	—
		231			—	—	7464	6848
	190–320	215	032S	032L	6981	6296	—	—
		231			—	—	7739	7054
	190–320	215	032L	032L	7364	6591	—	—
		231			—	—	8122	7349
	190–320	215	050S	050S	8934	7800	—	—
		231			—	—	9715	8581
	190–320	215	050S	050L	9395	8143	—	—
		231			—	—	10176	8924
	190–320	215	050L	050L	9901	8474	—	—
		231			—	—	10721	9300
	300–500	360	050S	050S	9665	8530	—	—
		379			—	—	10255	9120
	300–500	360	050S	050L	10126	8874	—	—
		379			—	—	10716	9464
	300–500	360	050L	050L	10670	9249	—	—
		379			—	—	11260	9839
	300–500	360	050S	080S	11305	9793	—	—
		379			—	—	11895	10383
300–500	360	080S	080S	13943	12029	—	—	
	379			—	—	14534	12619	
300–500	360	080S	080L	14664	12611	—	—	
	379			—	—	15254	13201	
300–500	360	080L	080L	15580	13254	—	—	
	379			—	—	16171	13844	

## Unit Specifications – International System (SI) Units

**Table 34. Weights, 50 Hz chillers (kg) — CVHE, CVHG, and CDHG chillers (continued)**

Model	Comp Size	CPKW	Evap Size	Cond Size	Weights without Starters		Weights with Starters	
	NTON		EVSZ	CDSZ	Operating	Shipping	Operating	Shipping
CVHG	480–565	489	050S	050S	10096	8957	10349	9210
	480–565	489	050S	050L	10557	9300	10810	9553
	480–565	489	050L	050L	11064	9636	11316	9889
	480–565	489	050S	080S	11736	10223	11989	10476
	480–565	489	050L	080L	13024	11180	13276	11432
	480–565	489	080S	080L	15095	13043	15348	13295
	670–780	621	080S	080S	14947	13033	15199	13285
	670–780	621	080S	080L	15667	13615	15920	13867
	670–780	621	080L	080L	16584	14257	16836	14510
	670–780	621	080L	142L	20421	17329	20673	17581
	670–780	621	142M	142L	22461	18852	22714	19105
	670–780	621	142L	142L	23038	19266	23290	19519
	920–1100	621	080L	142L	20904	17812	21157	18065
	920–1100	892	142M	142L	23128	19519	23380	19772
	920–1100	892	142L	142L	23704	19933	23957	20186
	920–1100	892	142M	210L	25848	21718	26100	21970
	920–1100	892	142L	210L	26401	22132	26654	22384
	920–1100	892	142E	210L	27048	22579	27300	22832
	920–1100	892	210L	210L	28949	24381	29201	24634
CDHG	1250	621	210D	210D	45116	38108	45621	38613
	1750	621	210D	210D	45116	38108	45621	38613
	2150	892	210D	210D	47047	40051	47552	40557
	2250	892	210D	210D	46451	39441	46957	39947

**Notes:**

1. TECU tubes, 0.71 mm tube wall thickness.
2. 2068.4 kPaG non-marine waterboxes.
3. Heaviest possible bundle and motor combination.
4. Operating weights assume the largest possible refrigerant charge.
5. Weights with starters assume the heaviest possible starter (AFD when it's an allowed option).
6. Industrial Control Panel (INDP) option, add 23 kg.
7. Control Power Transformer (CPTR) option, add 59 kg.
8. Supplemental Motor Protection (SMP) option, add 227 kg.



## Unit Specifications – International System (SI) Units

**Table 35. Representative weights, 50 Hz chillers (kg)**

Model	Comp Size	CPKW	Evap Size	Cond Size	Weights without Starters	
	NTON		EVSZ	CDSZ	Operating	Shipping
CVHH	950–1050	1023	100M	100M	22237	19343
	950–1050	1023	100L	100L	23053	19931
	950–1050	1023	100M	10HM	25729	22463
	950–1050	1023	130M	130M	24763	21146
	950–1050	1023	130M	13HM	28988	25003
	950–1050	1023	160M	200M	29655	25104
	950–1050	1023	200L	220L	33424	27513
	950–1050	1023	220L	220L	36653	30113
	1550	1023	200L	200L	32815	27470
	1550	1023	200L	20HL	37052	31292
	1550	1023	220L	220L	36517	29977
	1550	1023	220L	22HL	43010	36053
CDHH	1750–2250	1023	400M	440M	58001	47345
	3050	1023	440M	440M	62199	50415
	3050	1023	440X	440X	65527	52738
	3050	1023	440M	44HM	74811	57693
	3050	1023	440X	44HX	79753	60481

**Notes:**

1. TECU tubes, 0.71 mm tube wall thickness.
2. 2068.4 kPaG marine waterboxes.
3. Heaviest possible bundle and motor combination.
4. Operating weights assume the largest possible refrigerant charge.
5. Industrial Control Panel (INDP) option, add 23 kg.
6. Control Power Transformer (CPTR) option, add 127 kg.
7. Supplemental Motor Protection (SMP) option, add 227 kg.
8. To calculate the maximum chiller weight with starter/drive, add the starter/AFD weight from the following table (maximum weights, unit-mounted starters/AFDs [kg]) to the chiller maximum weight from this table. Note that Duplex™ chiller models CDHH will have two starters, one for each compressor.

**Table 36. Maximum weights, unit-mounted starters/Adaptive Frequency™ Drives (AFD) (kg)**

Low Voltage (less than 600 volts)	Wye-delta	253
	900 amp	1361
Adaptive Frequency Drive (less than 600 volts)	1210 amp	1361
	Across-the-line	296
Medium Voltage (2300–6600 volts)	Primary Reactor	727
	Autotransformer	772

*Note: All weights are nominal and ±10%.*



## Physical Dimensions

### Single Compressor Chillers

**Notes:**

- Physical dimensions without unit-mounted starters. Refer to the following tables for SI data for single compressor CenTraVac™ chillers; refer to “Single Compressor Chillers,” p. 59 for I-P data for single compressor CenTraVac™ chillers.
- Refer to Figure 21, p. 59 for space envelope information for single compressor CenTraVac™ chillers.

**Table 37. Chiller water connection pipe size (mm) — CVHE, CVHF, and CVHG chillers**

Water Passes	Shell Size					
	032	050	080	142	210	250
Evaporator	Metric Pipe Size					
1 Pass	DN200	DN250	DN350	DN400	DN400	DN400
2 Pass	DN150	DN200	DN250	DN300	DN350	DN350
3 Pass	DN125	DN150	DN200	DN250	DN300	DN300
Condenser	Metric Pipe Size					
1 Pass	DN200	DN250	DN350	DN400	DN400	DN400
2 Pass	DN150	DN200	DN250	DN300	DN350	DN350

**Table 38. Chiller water connection pipe sizes (mm) — CVHH chillers**

Water Passes	Shell Size				
	100	130	160	200	220
Evaporator	Metric Pipe Size				
1 Pass	DN300	DN300	DN350	DN400	DN500
2 Pass	DN250	DN250	DN300	DN350	DN350
3 Pass	DN200	DN200	DN250	DN300	DN300
Condenser	Metric Pipe Size				
1 Pass	DN300	DN350	—	DN400	DN600
2 Pass	DN250	DN300	—	DN350	DN350



## Unit Specifications – International System (SI) Units

**Table 39. Physical dimensions for 60 Hz compressor chillers (mm) — CVHE and CVHF chillers**

Model	Comp Size	Shell Size	Shell Arrange	Envelope				Clearance		Base Unit Dimensions		
				Length	Width			Tube Pull				
					Terminal Box Only	LV Unit Mounted Starters <sup>(a)</sup>	LV Unit Mounted AFD					
				E <sub>L</sub>	E <sub>W</sub>	E <sub>W</sub>	E <sub>W</sub>	C <sub>L1</sub>	C <sub>L2</sub>	Length	Height	Width
CVHE	230–320	032	SS	8052	3353	3404	3810	3581	1041	3429	2383	1755
			SL / LL	10351	3353	3404	3810	4731	1041	4578	2383	1755
		050	SS	8077	3429	3734	4013	3581	1067	3429	2497	2407
			SL / LL	10376	3429	3734	4013	4731	1067	4578	2497	2047
	360–500	050	SS	8077	3429	3734	4013	3581	1067	3429	2507	2045
			SL / LL	10376	3429	3734	4013	4731	1067	4578	2507	2045
		050/080	SS	8331	3658	3785	4242	3581	1321	3429	2637	2293
			LL	10630	3658	3785	4242	4731	1321	4578	2637	2293
		080	SS	8331	3886	4013	4267	3581	1321	3429	2918	2459
			SL / LL	10630	3886	4013	4267	4731	1321	4578	2918	2459
CVHF	350–570	050	SS	8077	3404	3734	3785	3581	1067	3429	2540	2042
			SL / LL	10376	3404	3734	3785	4731	1067	4578	2540	2042
		050/080	SS	8331	3658	3785	4242	3581	1321	3429	2631	2291
			LL	10630	3658	3785	4242	4731	1321	4578	2631	2291
		080	SS	8331	3861	3988	4242	3581	1321	3429	2913	2456
			SL / LL	10630	3861	3988	4242	4731	1321	4578	2913	2456
	650–910	080	SS	8331	4089	3988	4445	3581	1321	3429	2918	2469
			SL / LL	10630	4089	3988	4445	4731	1321	4578	2918	2469
		080/142	LL	10808	4445	4445	5029	4731	1499	4578	2992	3071
		142	ML / LL	10808	4369	4293	4978	4731	1499	4578	3081	2931
	1070–1300	080/142	LL	10808	4496	4470	5055	4731	1499	4578	3089	3091
			ML / LL	10808	4496	4394	5055	4731	1499	4578	3086	3005
		142	EL	11951	4496	4394	5055	5302	1499	5150	3086	3005
			ML / LL	10820	4699	4597	5334	4731	1499	4578	3274	3221
		142/210	EL	11963	4699	4597	5334	5302	1499	5150	3274	3221
			LL	10808	4623	4521	5182	4731	1499	4578	3434	3170
		210	LL	10808	4623	4521	5182	4731	1499	4578	3434	3170
		250	EL	12027	4581	4953	5385	5302	1575	5150	3538	3487
	1470–1720	142/210	LL	10820	4609	4750	5258	4731	1499	4578	3326	3223
			EL	11963	4597	4750	5258	5302	1499	5150	3326	3223
210		LL	10808	4801	4724	5207	4731	1499	4578	3485	3167	
250		EL	12027	4851	4953	5385	5302	1575	5150	3592	3487	

**Notes:**

1. C<sub>L1</sub> can be at either end of the machine and is required for tube pull clearance.
2. C<sub>L2</sub> is always at the opposite end of the machine from C<sub>L1</sub> and is required for service clearance.
3. DMP = Differential Motor Protection
4. SMP = Supplemental Motor Protection, no unit-mounted starter
5. CPTR = Control Power Transformer option, no unit-mounted starter
6. Refer to [Figure 21, p. 59](#) for the space envelope for single compressor CenTraVac™ chillers.

<sup>(a)</sup> Dimensions for low-voltage unit-mounted starters. Medium-voltage starters are also available for unit mounting.

## Unit Specifications – International System (SI) Units

**Table 40. Physical dimensions for 60 and 50 Hz single compressor chillers (mm) — CVHH chillers**

Units	Comp Size	Shell Configuration Evap/Cond	Space Envelope		Clearance		Base Unit Dimensions		
			Length (E <sub>L</sub> )	Terminal Box Only (E <sub>W</sub> )	Tube Pull		Length	Height	Width
					C <sub>L</sub> 1	C <sub>L</sub> 2			
CVHH (50 Hz)	950 1050	100M/100M	9474	4470	4216	1194	4064	3078	3099
		100L/100L	10503	4470	4731	1194	4578	3078	3099
		130M/130M	9474	4524	4216	1194	4064	3248	3152
		160M/200M	9474	4575	4216	1194	4064	3439	3203
		200L/220L	10503	4704	4731	1194	4578	3498	3332
		220L/220L	10503	4878	4731	1194	4578	3597	3507
	1550	200L/200L	10503	4600	4731	1194	4578	3498	3228
		220L/220L	10503	4878	4731	1194	4578	3597	3507
CVHH Heat Recovery (50 Hz)	950 1050	100M/10HM	9474	4872	4216	1194	4064	3078	3500
		130M/13HM	9474	4928	4216	1194	4064	3248	3556
		160M/20HM	9474	5097	4216	1194	4064	3439	3725
	1550	200L/20HL	10503	5177	4731	1194	4578	3498	3805
		220L/22HL	10503	5728	4731	1194	4578	3597	4356
CVHH (60 Hz)	900 1000 1200	100M/100M	9474	4470	4216	1194	4064	3078	3099
		100L/100L	10503	4470	4731	1194	4578	3078	3099
		130M/130M	9474	4521	4216	1194	4064	3248	3150
		160M/200M	9474	4575	4216	1194	4064	3439	3203
		200L/220L	10503	4704	4731	1194	4578	3498	3332
		220L/220L	10503	4878	4731	1194	4578	3597	3507
	1500 1700	200L/200L	10503	4600	4731	1194	4578	3498	3228
		220L/220L	10503	4878	4731	1194	4578	3597	3507
CVHH Heat Recovery (60 Hz)	900 1000 1200	100M/10HM	9474	4872	4216	1194	4064	3078	3500
		130M/13HM	9474	4928	4216	1194	4064	3248	3556
		160M/20HM	9474	5097	4216	1194	4064	3439	3725
	1500 1700	200L/20HL	10503	5177	4731	1194	4578	3498	3805
		220L/22HL	10503	5639	4731	1194	4578	3597	4267

**Notes:**

1. Dimensions do not include waterboxes, hinges, starters, or other unit-mounted options that may affect unit size. Contact your Trane representative for more information.
2. C<sub>L</sub>1 can be at either end of the machine and is required for tube pull clearance.
3. C<sub>L</sub>2 is always at the opposite end of the machine from C<sub>L</sub>1 and is required for service clearance.
4. Physical dimensions do NOT include unit-mounted starters.
5. Refer to [Figure 21](#), p. 59 for the space envelope for single compressor CenTraVac™ chillers.



## Unit Specifications – International System (SI) Units

**Table 41. Physical dimensions for 50 Hz compressor chillers (mm) — CVHE and CVHG chillers**

Model	Comp Size	Shell Size	Shell Arrange	Envelope			Clearance		Base Unit Dimensions		
				Length	Width		Tube Pull				
					E <sub>L</sub>	Terminal Box Only			LV Unit Mounted Starters <sup>(a)</sup>	C <sub>L1</sub>	C <sub>L2</sub>
CVHE	190–270	032	SS	8052	3353	3404	3581	1041	3429	2383	1755
			SL / LL	10351	3353	3404	4731	1041	4578	2383	1755
		050	SS	8077	3429	3734	3581	1067	3429	2497	2047
			SL / LL	10376	3429	3734	4731	1067	4578	2497	2047
	300–420	050	SS	8077	3429	3734	3581	1067	3429	2507	2047
			SL / LL	10376	3429	3734	4731	1067	4578	2507	2047
		050/080	SS	8331	3658	3785	3581	1321	3429	2637	2294
			LL	10630	3658	3785	4731	1321	4578	2637	2294
		080	SS	8331	3886	4013	3581	1321	3429	2918	2461
			SL / LL	10630	3886	4013	4731	1321	4578	2918	2461
CVHG	480–565	050	SS	8077	3429	3759	3581	1067	3429	2614	2052
			SL / LL	10376	3429	3759	4731	1067	4578	2614	2052
		050/080	SS	8331	3708	3861	3581	1321	3429	2659	2322
			LL	10630	3708	3861	4731	1321	4578	2659	2322
		080	SS	8331	3937	3835	3581	1321	3429	2941	2466
			SL / LL	10630	3937	3835	4731	1321	4578	2941	2466
	670–780	080	SS	8331	3886	4039	3581	1321	3429	2918	2466
			SL / LL	10630	3886	4039	4731	1321	4578	2918	2466
		080/142	LL	10808	4445	4445	4731	1499	4578	2992	3071
		142	ML / LL	10808	4420	4318	4731	1499	4578	3081	2934
	920–1067	080/142	LL	10808	4496	4470	4731	1499	4578	3028	3094
		142	ML / LL	10808	4420	4318	4731	1499	4578	3076	2931
		142/210	ML / LL	10808	4699	4597	4724	1499	4578	3215	3220
			EL	11951	4699	4597	5309	1499	5150	3215	3220
		210	LL	10808	4623	4547	4731	1499	4578	3373	3165
	1100	080/142	LL	10808	4496	4470	4731	1499	4578	3089	3094
		142	ML / LL	10808	4496	4394	4731	1499	4578	3086	3005
		210	LL	10808	4623	4547	4731	1499	4578	3434	3165

**Notes:**

1. C<sub>L1</sub> can be at either end of the machine and is required for tube pull clearance.
2. C<sub>L2</sub> is always at the opposite end of the machine from C<sub>L1</sub> and is required for service clearance.
3. DMP = Differential Motor Protection
4. SMP = Supplemental Motor Protection, no unit-mounted starter
5. CPTR = Control Power Transformer option, no unit-mounted starter
6. Refer to Figure 21, p. 59 for the space envelope for single compressor CenTraVac™ chillers.

<sup>(a)</sup> Dimensions for low-voltage unit-mounted starters. Medium-voltage starters are also available for unit mounting.

## Dual Compressor Chillers

**Notes:**

- Physical dimensions without unit-mounted starters. Refer to the following table for SI data for dual compressor CenTraVac™ chillers; refer to “Dual Compressor Chillers,” p. 63 for I-P data for dual compressor CenTraVac™ chillers.
- Refer to [Figure 22, p. 63](#) for space envelope information for dual compressor CenTraVac™ chillers.

**Table 42. Chiller water connection pipe sizes (mm) — CDHF and CDHG chillers**

Water Passes	Shell Size			
	210D	250D	250M	250X
Evaporator	Nominal Pipe Size			
1 Pass	DN400	DN400	458	458
Condenser	Nominal Pipe Size			
1 Pass	DN400	DN400	508	508

**Table 43. Chiller water connection pipe sizes (mm) — CDHH chillers**

Water Passes	Shell Size	
	400	440
Metric Pipe Size		
1 Pass	DN400	DN500
2 Pass	—	—
3 Pass	—	—
Condenser		
1 Pass	—	DN600
2 Pass	—	—



## Unit Specifications – International System (SI) Units

**Table 44. Physical dimensions dual 60 and 50 Hz compressor units (mm) — CDHF and CDHG chillers**

Model	Comp Size	Shell Size	Shell Arrange	Envelope				Clearance		Base Unit Dimensions		
				Length	Width			Tube Pull				
					Terminal Box Only	MV Unit Mounted Starters	LV Unit Mounted AFD			C <sub>L1</sub>	C <sub>L2</sub>	Length
E <sub>L</sub>	E <sub>W</sub>	E <sub>W</sub>	E <sub>W</sub>	C <sub>L1</sub>	C <sub>L2</sub>	Length	Height	Width				
CDHF	1500	210	DD	15392	4628	5156	5283	6706	2134	6553	3378	3174
	2000											
	2170	250	DD	15392	4928	5258	5461	6706	2134	6553	3538	3474
	2550											
	3000	250	MM	18136	4928	5258	5461	8077	2134	7925	3586	3472
	3500	250	XX	20574	4928	5258	5461	9296	2134	9144	3586	3472
CDHG	1250	210	DD	15392	4699	5207	N/A	6706	2134	6553	3377	3172
	1750											
	2250	210	DD	15392	4674	5182	N/A	6706	2134	6553	3435	3172

**Notes:**

1. C<sub>L1</sub> can be at either end of the machine and is required for tube pull clearance.
2. C<sub>L2</sub> is always at the opposite end of the machine from C<sub>L1</sub> and is required for service clearance.
3. Refer to Figure 22, p. 63 for the space envelope for dual compressor CenTraVac™ chillers.

**Table 45. Physical dimensions for 60 and 50 Hz dual compressor chillers (mm) — CDHH chillers**

Units	Comp Size	Shell Configuration EVAP/COND	Space Envelope		Clearance		Base Unit Dimensions		
			Length (E <sub>L</sub> )	Terminal Box Only (E <sub>W</sub> )	Tube Pull		Length	Height	Width
					C <sub>L1</sub>	C <sub>L2</sub>			
CDHH (50 Hz)	1750	400M/440M	17729	4704	8077	1727	7925	3498	3332
	2250								
	3050	440M/440M	17932	4878	8077	1930	7925	3597	3507
		440X/440X	20371	4878	9296	1930	9144	3597	3507
		440M/44HM	17932	4878	8077	1930	7925	3597	3507
CDHH (60 Hz)	2000	400M/440M	17729	4704	8077	1727	7925	3498	3332
	2600								
	2800	440M/440M	17932	4878	8077	1930	7925	3597	3507
	3300	440X/440X	20371	4878	9296	1930	9144	3597	3507
	2800	440M/44HM	17932	4878	8077	1930	7925	3597	3507
	3300	440X/44HX	20371	4878	9296	1930	9144	3597	3507

**Notes:**

1. Dimensions do not include waterboxes, hinges, starters, or other unit-mounted options that may affect unit size. Contact your Trane representative for more information.
2. C<sub>L1</sub> can be at either end of the machine and is required for tube pull clearance.
3. C<sub>L2</sub> is always at the opposite end of the machine from C<sub>L1</sub> and is required for service clearance.
4. Refer to Figure 22, p. 63 for the space envelope for dual compressor CenTraVac™ chillers.

## Waterbox Lengths

Table 46. 1034.2 kPaG waterbox lengths (mm) — CDHF, CDHG, CVHE, CVHF, and CVHG chillers

Shell	Passes	Evaporator		Condenser	
		Supply Length	Return Length	Supply Length	Return Length
<b>Non-Marine Waterboxes</b>					
320	1	325	—	330	—
	2	325	173	235	154
	3	325	—	—	—
500	1	324	—	374	—
	2	323	188	374	202
	3	323	—	—	—
800	1	335	—	404	—
	2	335	185	357	224
	3	335	—	—	—
1420	1	370	—	482	—
	2	370	214	443	345
	3	370	—	—	—
2100	1	406	—	496	—
	2	406	243	455	359
	3	406	—	—	—
2500	1	480	—	521	—
	2	479	264	489	384
	3	479	—	—	—
2100 (Duplex™)	1	406	—	495	—
2500 (Duplex™)	1	480	—	521	—
<b>Marine Waterboxes</b>					
320	1	403	—	435	—
	2	403	173	426	154
	3	403	—	—	—
500	1	464	—	542	—
	2	464	188	405	202
	3	464	—	—	—
800	1	590	—	583	—
	2	590	185	591	224
	3	590	—	—	—
1420	1	709	—	1004	—
	2	709	214	953	345
	3	709	—	—	—
2100	1	721	—	1030	—
	2	721	243	973	359
	3	721	—	—	—
2500	1	766	—	1144	—
	2	766	264	1042	384
	3	—	—	—	—



## Unit Specifications – International System (SI) Units

**Table 46. 1034.2 kPaG waterbox lengths (mm) — CDHF, CDHG, CVHE, CVHF, and CVHG chillers (continued)**

Shell	Passes	Evaporator		Condenser	
		Supply Length	Return Length	Supply Length	Return Length
2100 (Duplex™)	1	721	—	1029	—
2500 (Duplex™)	1	767	—	1143	—

**Table 47. 2068.4 kPaG waterbox lengths (mm) — CDHF, CDHG, CVHE, CVHF, and CVHG chillers**

Shell	Passes	Evaporator		Condenser	
		Supply Length	Return Length	Supply Length	Return Length
<b>Non-Marine Waterboxes</b>					
320	1	325	—	339	—
	2	325	173	510	193
	3	325	—	—	—
500	1	324	—	393	—
	2	322	171	619	263
	3	323	—	—	—
800	1	349	—	402	—
	2	349	199	627	268
	3	349	—	—	—
1420	1	387	—	535	—
	2	387	241	491	403
	3	387	—	—	—
2100	1	—	—	562	—
	2	—	250	521	400
	3	—	—	—	—
2500	1	539	—	625	—
	2	539	335	555	440
	3	539	—	—	—
2100 (Duplex™)	1	—	—	562	—
2500 (Duplex™)	1	539	—	625	—
<b>Marine Waterboxes</b>					
320	1	403	—	437	—
	2	403	173	431	193
	3	403	—	—	—
500	1	480	—	600	—
	2	480	171	463	209
	3	480	—	—	—
800	1	642	—	725	—
	2	642	179	712	217
	3	642	—	—	—
1420	1	760	—	890	—
	2	760	224	839	246
	3	760	—	—	—



## Unit Specifications – International System (SI) Units

**Table 47. 2068.4 kPaG waterbox lengths (mm) — CDHF, CDHG, CVHE, CVHF, and CVHG chillers (continued)**

Shell	Passes	Evaporator		Condenser	
		Supply Length	Return Length	Supply Length	Return Length
2100	1	804	—	984	—
	2	804	250	886	348
	3	804	—	—	—
2500	1	860	—	971	—
	2	—	—	971	375
	3	—	—	—	—
2100 (Duplex™)	1	804	—	984	—
2500 (Duplex™)	1	860	—	971	—

**Table 48. 1034.2 kPaG waterbox lengths (mm) — CDHH and CVHH chillers**

Shell	Passes	Evaporator		Condenser	
		Supply Length	Return Length	Supply Length	Return Length
<b>Non-Marine Waterboxes</b>					
100M/L	1	515	515	470	470
	2	555	350	518	302
	3	490	490	—	—
130M	1	544	544	545	545
	2	588	376	543	341
	3	518	518	—	—
160M	1	592	592	—	—
	2	592	389	—	—
	3	573	573	—	—
200M/L	1	440	440	536	536
	2	430	243	537	359
	3	413	413	—	—
220L	1	466	466	559	559
	2	447	264	563	384
	3	444	444	—	—
400M	1	440	592	536	536
440M/X	1	466	466	559	559
44HM/HX	1	466	466	559	559
10HM	1	—	—	433	433
	2	—	—	520	220
13HM	1	—	—	433	433
	2	—	—	520	220
20HM/L	1	—	—	512	512
	2	—	—	519	220



## Unit Specifications – International System (SI) Units

**Table 48. 1034.2 kPaG waterbox lengths (mm) — CDHH and CVHH chillers (continued)**

Shell	Passes	Evaporator		Condenser	
		Supply Length	Return Length	Supply Length	Return Length
22HM/L	1	—	—	443	443
	2	—	—	519	220
<b>Marine Waterboxes</b>					
100M/L	1	1018	1018	949	949
	2	1018	351	949	302
	3	1018	1018	—	—
130M	1	1043	1043	987	987
	2	1043	376	987	341
	3	1043	1043	—	—
160M	1	1207	1207	—	—
	2	1176	389	—	—
	3	1176	1176	—	—
200M/L	1	885	885	1111	1111
	2	885	243	1047	359
	3	885	802	—	—
220L	1	993	993	1322	1322
	2	993	264	1054	384
	3	—	—	—	—
400M	1	885	885	—	—
440M/X	1	993	993	1322	1322

**Table 49. 2068.4 kPaG waterbox lengths (mm) — CDHH and CVHH chillers**

Shell	Passes	Evaporator		Condenser	
		Supply Length	Return Length	Supply Length	Return Length
<b>Non-Marine Waterboxes</b>					
100M/L	1	—	—	507	507
	2	—	211	518	315
	3	—	—	—	—
130M	1	—	—	557	557
	2	—	211	568	356
	3	—	—	—	—
160M	1	—	—	—	—
	2	—	214	—	—
	3	—	—	—	—
200M/L	1	—	—	565	565
	2	—	250	565	318
	3	—	—	—	—

## Unit Specifications – International System (SI) Units

**Table 49. 2068.4 kPaG waterbox lengths (mm) — CDHH and CVHH chillers (continued)**

Shell	Passes	Evaporator		Condenser	
		Supply Length	Return Length	Supply Length	Return Length
220L	1	538	538	633	633
	2	538	334	599	373
	3	538	538	—	—
400M	1	—	—	565	565
440M/X	1	538	538	633	633
<b>Marine Waterboxes</b>					
100M/L	1	712	712	963	963
	2	712	211	912	315
	3	712	607	—	—
130M	1	712	712	1034	1034
	2	712	211	989	356
	3	712	607	—	—
160M	1	742	742	—	—
	2	742	214	—	—
	3	742	662	—	—
200M/L	1	984	984	992	992
	2	984	250	924	318
	3	984	901	—	—
220L	1	1152	1152	1381	1381
	2	1152	337	1113	373
	3	—	—	—	—
400M	1	984	984	—	—
440M/X	1	1152	1152	1381	1381



# Mechanical Specifications

## Compressor

### Inlet Guide Vanes

Fully modulating variable inlet guide vanes provide capacity control. The guide vanes are controlled by an externally-mounted electric vane operator in response to refrigeration load on the evaporator.

### Impellers

Fully shrouded impellers made of high strength aluminum alloy are directly connected to the motor rotor shaft operating at 3600 rpm (60 Hz) or 3000 rpm (50 Hz). The impellers are dynamically balanced and over-speed tested at 4500 rpm (60 Hz) and 3750 (50 Hz). The motor-compressor assembly is balanced to a maximum vibration of 0.15 in./s (3.8 mm/s) at 3600 rpm (60 Hz) or 3000 rpm (50 Hz) as measured on the motor housing.

### Compressor Casing

Separate volute casings of refrigerant-tight, close-grained cast iron are used on the centrifugal compressor; each incorporating a parallel wall diffuser surrounded by a collection scroll. The diffuser passages are machined to ensure high efficiency. All casings are proof- and leak-tested.

### Motor

Compressor motors are hermetically sealed two-pole, squirrel cage induction-type. Compressor motors are built in accordance with Trane specifications and guaranteed by the manufacturer for continuous operation at the nameplate rating. A load-limit system provides protection against operation in excess of this rating. The rotor shaft is heat-treated carbon steel and designed such that the critical speed is well above the operating speed. The control circuit prevents motor energization unless positive oil pressure is established. Impellers are keyed directly to the motor shaft and locked in position. Nonferrous, labyrinth-type seals minimize recirculation and gas leakage between the stages of the compressor.

200–600V, 3-phase 60 Hz and 380–415V, 3-phase 50 Hz motors are supplied with six terminal posts for reduced-voltage wye-delta starting. For low-voltage and AFDs, connecting links are furnished to convert the motor to a 3-lead motor.

2300–13800V, 3-phase 60 Hz and 3300–11000V, 3-phase 50 Hz motors are supplied with three terminal posts for full-voltage (across-the-line) or reduced-voltage (primary reactor or autotransformer) starting. Motor terminal pads are supplied. A removable sheet metal terminal box encloses the terminal board area.

### Motor Cooling

Motor cooling is accomplished by a patented refrigerant pump that supplies liquid refrigerant to the motor. The refrigerant circulates uniformly over the stator windings and between the rotor and stator. All motor windings are specifically insulated for operation within a refrigerant atmosphere.

### Lubrication

A direct-drive, positive-displacement oil pump is driven by a 120-volt, single-phase, 3/4-hp motor. The motor and pump assembly are submerged in the oil sump to assure a positive oil supply to the compressor bearings at all times. A low watt-density heater maintains the oil temperature to minimize its affinity for refrigerant.

The oil pump for low voltage model CDHH and CVHH chillers is driven by a 380–600V, 50/60 Hz, 3-phase, 2 hp motor, while the oil pump for medium voltage models is driven by a 200–240V, 50/60 Hz, 1-phase, 2 hp motor. The motor and pump assembly are submerged in the oil sump to ensure a positive oil supply to the compressor bearings at all times. Two low watt density heaters maintain the oil temperature to minimize its affinity for refrigerant.

The oil tank is constructed in accordance with ASME Section VIII, Division I. It is designed with an open internal volume to accommodate the separation of refrigerant vapor from oil during operation. An electrically actuated ball valve prevents foaming and oil loss during a chiller start. It utilizes two heater

elements and a cooling sub-system that consists of a small brazed plate heat exchanger working in combination with a solenoid valve.

## Evaporator

### Shell and Waterboxes

For CDHF, CDHG, CVHE, and CVHF chillers, the evaporator shell is constructed of carbon steel plate and incorporates a carbon rupture disc in accordance with the ANSI/ASHRAE 15 Safety Code; for CDHH and CVHH, the evaporator shell is constructed of carbon steel plate and incorporates a steel rupture disc in accordance with the ASME Section VIII, Division I. A refrigerant temperature coupling is provided for a low limit controller or customer use.

Multiple pass arrangements are available at 150 psig (1034.2 kPaG) or 300 psig (2068.4 kPaG) water side working pressures, with grooved connections. Flanged connections and/or marine-type waterboxes are also available.

### Tube Sheets

A thick carbon steel tube sheet is welded to each end of the shell and then drilled and reamed to accommodate the tubes. Three annular grooves are machined into each tube hole to provide a positive liquid and vapor seal between the refrigerant and water side of the shell after tube rolling. Intermediate tube support sheets are positioned along the length of the shell to avoid contact and relative motion between adjacent tubes.

### Tubes

Individually replaceable, seamless tubing available in a variety of materials, depending on the customer's needs, is used as the evaporator heat transfer surface; tubing is available in either 1 inch (25 mm) or 0.75 inch (19 mm) outside diameter. Tubes are externally and internally enhanced, and mechanically expanded into the tube sheets (and are secured to the intermediate supports with tube clips) to provide a leak-free seal and eliminate tube contact and abrasion due to relative motion.

### Eliminators

Multiple layers of metal mesh screen form the eliminators and are installed over the tube bundle along the entire length of the evaporator. The eliminators prevent liquid refrigerant carryover into the compressor.

### Refrigerant Distribution

A refrigerant distributor on the base of the evaporator assures uniform wetting of the heat transfer surface over the entire length of the shell and under varying loads. High velocity, refrigerant-spray impingement on the tubes is prevented through this design.

### Refrigerant Flow Control

A multiple orifice flow-control system maintains the correct pressure differential between the condenser, economizer, and evaporator over the entire range of loading. This patented system contains no moving parts.

### Shell Tests

Models CDHF, CDHG, CVHE, CVHF, and CVHG: The refrigerant side of the evaporator shell, complete with tubes but without waterbox covers, is proof-tested at 45 psig (310.3 kPaG), vacuum leak-tested, and finally pressure leak-tested with a helium mass spectrometer. The water side of the evaporator shell, with waterboxes in place, is hydrostatically tested at 1.5 times the design working pressure, but not less than 225 psig (1551.3 kPaG).

Models CDHH and CVHH: The refrigerant side of the evaporator shell, complete with tubes but without waterbox covers, is proof-tested at 65 psig (448.2 kPaG) for ASME and 71.5 psig (493.0 kPaG) for PED (European Code), vacuum leak-tested, and finally pressure leak-tested with a helium mass spectrometer. The water side of the evaporator shell, with waterboxes in place, is hydrostatically tested at 1.3 times the design working pressure, but not less than 195 psig (1344.5 kPaG) for 150 psig (1034.2 kPaG) waterboxes or 390 psig (2689.0 kPaG) for 300 psig (2068.4 kPaG) waterboxes.



*Note: These tests are not to be repeated at installation.*

# Condenser/Heat Recovery Condenser

## Shell and Waterboxes

The condenser shell is constructed of carbon steel plate designed and constructed in accordance with ANSI/ASHRAE 15 Safety Code (for CDHF, CDHG, CVHE, CVHF, and CVHG chillers) or ASME Section VIII, Division I (for CDHH and CVHH chillers).

Multiple pass arrangements are available at 150 psig (1034.2 kPaG) or 300 psig (2068.4 kPaG) water side working pressures, with grooved connections. Flanged connections and/or marine-type waterboxes are also available.

## Tube Sheets

A thick carbon steel tube sheet is welded to each end of the shell and is drilled and reamed to accommodate the tubes. Three annular grooves are machined into each tube hole to provide a positive liquid and vapor seal between the refrigerant and water sides of the shell after tube rolling. Intermediate tube support sheets are positioned along the length of the shell to avoid contact and relative motion between adjacent tubes.

## Tubes

Individually replaceable, seamless copper tubing available in either 1 in. (25 mm) or 0.75 in. (19 mm) outside diameter is used as the condenser heat transfer surface. Tubes are externally and internally enhanced, and mechanically expanded into the tube sheets (and are secured to the intermediate supports with tube clips) to provide a leak-free seal and eliminate tube contact and abrasion due to relative motion.

## Refrigerant Gas Distribution

A baffle plate between the tube bundle and the condenser shell distributes the hot compressor-discharge gas longitudinally throughout the condenser and downward over the tube bundle. The baffle plate prevents direct impingement of high velocity compressor-discharge gas upon the tubes.

## Shell Tests

Models CDHF, CDHG, CVHE, CVHF, and CVHG: The refrigerant side of the condenser shell, complete with tubes, but without waterbox covers, is proof-tested at 45 psig (310.3 kPaG), vacuum leak-tested, and finally pressure leak-tested with a helium mass spectrometer. The water side of the condenser shell, with waterboxes in place, is hydrostatically tested at 1.5 times the design working pressure, but not less than 225 psig (1551.3 kPaG).

Models CDHH and CVHH: The refrigerant side of the condenser shell, complete with tubes, but without waterbox covers, is proof-tested at 65 psig (448.2 kPaG), vacuum leak-tested, and finally pressure leak-tested with a helium mass spectrometer. The water side of the condenser shell, with waterboxes in place, is hydrostatically tested at 1.3 times the design working pressure, but not less than 195 psig (1344.5 kPaG).

*Note: These tests are not to be repeated at installation.*

## Economizer

CVHE and CVHG CenTraVac™ chillers utilize two-stage economizer (single-stage economizer on CVHF units). CVHH two-stage (60 Hz) chillers utilize a single-stage economizer, and CVHH three-stage (50 Hz) chillers utilize a two-stage economizer.

The economizer is constructed in accordance with ASME Section VIII, Division I and consists of either one or two interstage pressure chambers which utilize a multiple orifice system to maintain the correct pressure differential between the condenser, economizer, and evaporator over the entire range of loading. This patented system contains no moving parts.

CDHF and CDHH Duplex™ models (60 Hz) models use a single-stage economizer per circuit. CDHG and CDHH Duplex™ (50 Hz) models use a two-stage economizer per circuit.

## Purge System

### Standard Features

Refer to *Purge System for Water-Cooled CenTraVac™ Chillers with Symbio Controls, R-514A Refrigerant Installation, Operation, and Maintenance* (PRGG-SVX002\*-EN).

## Symbio™ 800 Chiller Controller

The Symbio 800 microcomputer control panel is factory installed and tested on the CenTraVac™ chiller. All controls necessary for the safe and reliable operation of the chiller are provided including oil management (when required), purge operation, and interface to the starter or Adaptive Frequency Drive™ (AFD). The control system is powered by a control power transformer included in the starter panel. The microcomputer control system processes the leaving evaporator fluid temperature sensor signal to satisfy the system requirements across the entire load range.

The microprocessor controller is compatible with reduced-voltage or full-voltage electromechanical starters, or variable-speed drives. Depending on the applicability, the drives may be factory mounted or remote mounted.

The controller will load and unload the chiller via control of the stepper motor/actuator which drives the inlet guide vanes open or closed. The load range can be limited either by a current limiter or by an inlet guide vane limit (whichever controls the lower limit). It will also control the evaporator and condenser pumps to ensure proper chiller operation.

Approximately 200 diagnostic checks are made and displayed when a fault is detected. Fault information displayed includes target, severity, description, date and time. A diagnostic history displays the diagnostics with the time and date of their occurrence.

The panel features machine protection shutdown requiring *manual* reset for:

- Low oil flow
- Low oil temperature
- Actuator drive circuit fault
- Low differential oil pressure
- Extended compressor surge
- Loss of communication
- High condenser refrigerant pressure
- Critical sensor or detection circuit faults
- Low evaporator refrigerant temperature
- Free-cooling valve closure failure (free cooling applications only)

The AdaptiView display also provides reports that are organized into six groupings: Evaporator, Condenser, Compressor, Motor, Purge, and the ASHRAE Chiller Log. Each report contains data that is accessed by scrolling through the menu items. Each grouping will have a heading which describes the type of data in that grouping. This data includes:

- Phase currents
- Diagnostics
- Phase voltages
- Demand limit setpoint
- Water flows (optional)
- Purge suction temperature
- Oil temperature and pressures
- Motor winding temperatures
- Current chiller operating mode
- Water pressure drops (optional)
- Watts and power factor (optional)
- Bearing temperatures (optional)
- Outdoor air temperature (optional)
- Evaporator refrigerant temperature
- All water temperatures and setpoints
- Condenser liquid refrigerant temperature



## Mechanical Specifications

---

- Compressor starts and hours running
- Saturated refrigerant temperatures and pressures
- Refrigerant detection external to chiller in ppm (optional)
- Control source (i.e., local panel, external source, remote BAS)

The controller is capable of receiving signals from a variety of control sources (which are not mutually exclusive i.e., multiple control sources can coexist simultaneously) and of being programmed at the keypad as to which control source has priority. Control sources can be:

- Tracer® building controls (interface optional)
- The local operator interface (standard)
- A 4–20 mA or 2–10 Vdc signal from an external source (interface optional, control source not supplied by chiller manufacturer)
- Process computer (interface optional, control source not supplied by chiller manufacturer)
- Generic BAS (interface optional, control source not supplied by chiller manufacturer)

The control source with priority will then determine the active setpoints via the signal that is sent to the control panel.

## Isolation Pads

Isolation pads are supplied with each CenTraVac™ chiller for placement under all support points. They are constructed of molded neoprene.

## Refrigerant and Oil Charge

A full charge of refrigerant and oil is supplied with each unit. The oil ships in the unit's oil sump and the refrigerant ships directly to the job site from refrigerant suppliers.

## 0.0% Leak-Tight Warranty

The CenTraVac™ chiller features a 5-year limited Leak-Tight Warranty which is valid for the lesser of 60 months from initial start-up or 66 months from date of shipment. The limited Leak-Tight Warranty covers models CDHF, CDHH, CVHE, CVHF, and CVHH chillers installed in the United States or Canada. The Company's obligations and liabilities under this warranty are limited to furnishing replacement refrigerant due to manufacturing defect (as an example, a rupture disc blowing due to equipment room mishaps not covered). No other parts or labor are covered under this limited warranty. No liability whatever shall attach to the Company until appropriate actions have been taken (acceptable to Company) to eliminate the source of the leak, and then said liability shall be limited to furnishing the replacement refrigerant.

If the chiller is placed under a comprehensive Trane service and maintenance agreement (Trane "Select Agreement" or better) prior to the expiration of the standard Leak-Tight Warranty, the protection against refrigerant loss shall continue under the Trane Select Agreement for as long as an active Trane Select Agreement remains in effect without interruption.

If a 10-Year Parts, Labor and Refrigerant Warranty was purchased for the chiller and the chiller is placed under a Trane Select Agreement (or better) prior to the expiration of the 10-Year Parts, Labor and Refrigerant Warranty, the protection against refrigerant loss shall continue under the Trane Select Agreement for as long as an active Trane Select Agreement remains in effect without interruption.

## Thermometer Wells and Sight Glasses

In addition to the thermometer wells provided for use with the standard unit safety controls, a well is provided for measurement of the liquid refrigerant condensing temperature and a coupling for the evaporating temperatures. Sight glasses are provided for monitoring oil charge level and oil flow, compressor rotation, and purge condenser drum.

## Insulation

Factory applied insulation is available as an option on all units. All low temperature surfaces are covered with 3/4 in. (19 mm) Armaflex® II or equal, with a thermal conductivity = 0.28 Btu/h·ft<sup>2</sup> (0.79 W/m<sup>2</sup>), including the evaporator, waterboxes, and suction elbow and for CDHH and CVHH chillers, also



including the economizer and motor cooling lines. For CDHF, CDHG, CVHE, CVHF, and CVHG chillers, the economizer and motor cooling lines are insulated with 3/8 in. (9.5 mm) and 1/2 in. (12.7 mm) insulation respectively.

## Refrigerant Pumpout/Reclaim Connections

Connections are factory-provided as standard to facilitate refrigerant reclaim/removal required during maintenance or overhaul in accordance with ANSI/ASHRAE 15.

## Painting

All painted CenTraVac™ chiller surfaces are coated with a beige epoxy single coat that is baked to finish (on CVHE, CVHF, and CVHG chillers) or two coats of air-dry beige (primer and finish top coat) solvent-based enamel paint prior to shipment (on CDHF, CDHG, CDHH, and CVHH).

## Unit-Mounted Starter and Adaptive Frequency Drive Options

Low-voltage (200–600V) unit-mounted starters can be wye-delta or Adaptive Frequency™ Drive (AFD) in a NEMA 1 enclosure. Low-voltage unit-mounted starters can be wye delta (380–600V), or an Adaptive Frequency drive in a NEMA 1 enclosure (380–480V).

Medium-voltage starters (2300–6600V) are available to unit-mount on most sizes in across-the-line (full voltage), primary reactor, or autotransformer.

## Appendix A: Chiller Views

*Note: Each of the following figures show five different views of the various CenTraVac™ chillers: front, left, right, top, and rear view. These views and various combinations are used in “Appendix B: Evaporator Waterbox Configuration,” p. 100 and “Appendix C: Condenser Waterbox Configuration,” p. 104, and are intended to help you visualize the possible connections and combinations that may be available for your unit. You must contact your local Trane account manager to configure your selection for an as-built drawing to confirm it is available and to provide appropriate dimensions.*

**Figure 23. Front, left, right, top, and rear views—CDHF, CDHG, CVHE, CVHF, and CVHG chillers (CVHF unit shown)**

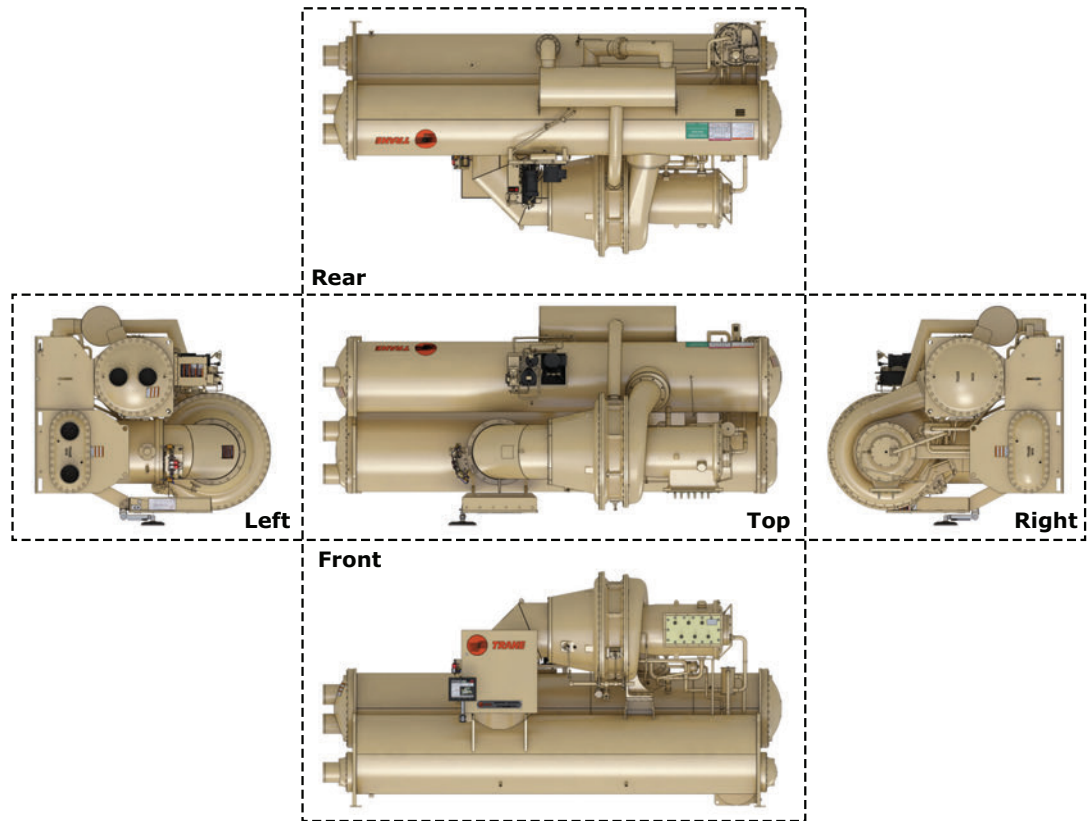
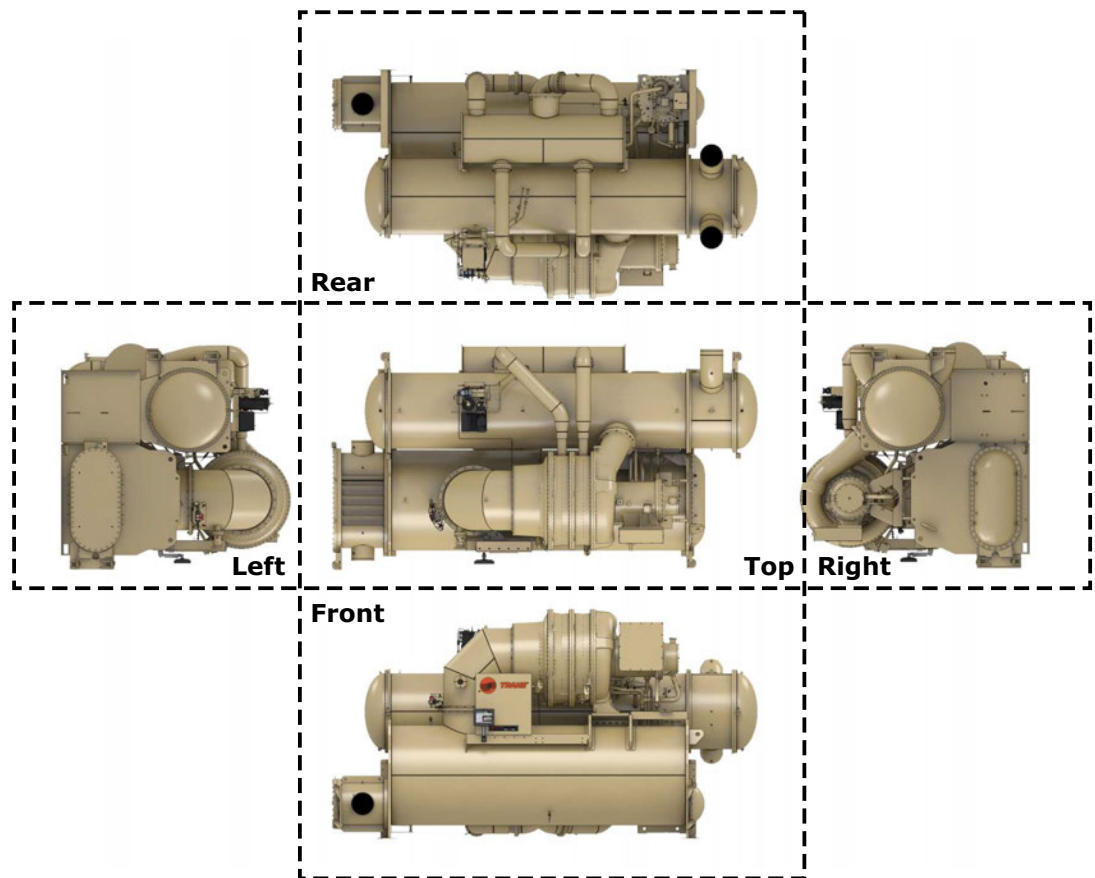


Figure 24. Front, left, right, top, and rear views—CDHH and CVHH chillers (CVHH unit shown)

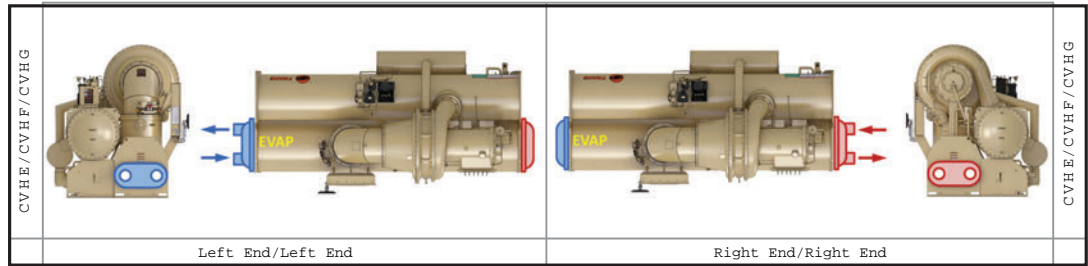


# Appendix B: Evaporator Waterbox Configuration

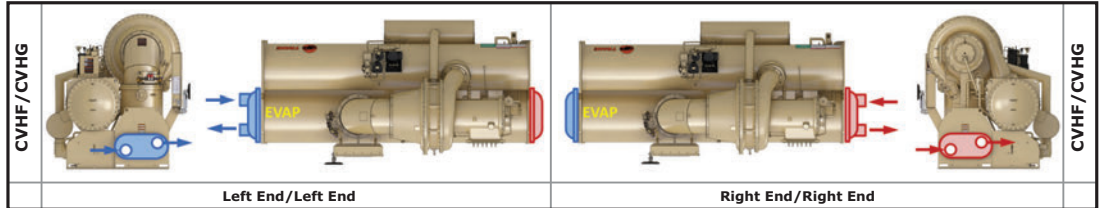
**Notes:**

- The following figures are intended to help you visualize the possible connections and combinations that may be available for your unit. You must contact your local Trane account manager to configure your selection for an as-built drawing to confirm it is available and to provide appropriate dimensions.
- Evaporator waterbox arrangements for models CDHH and CVHH differ from other CenTraVac™ chillers. Please contact your local Trane account manager for more information.

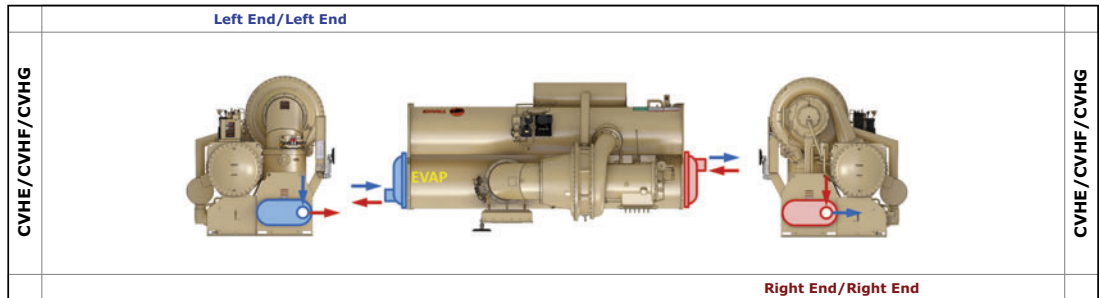
**Figure 25. Two-pass non-marine evaporator waterbox configurations**



**Figure 26. Two-pass non-marine evaporator waterbox configurations (250E only)**



**Figure 27. One-pass or three-pass non-marine evaporator waterbox configurations**



## Appendix B: Evaporator Waterbox Configuration

Figure 28. One-pass or three-pass non-marine evaporator waterbox configurations (250E only)

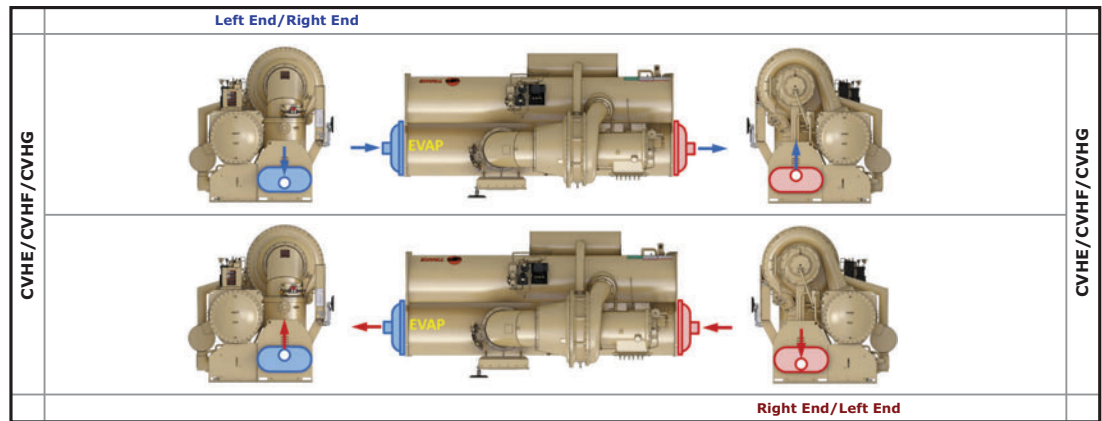
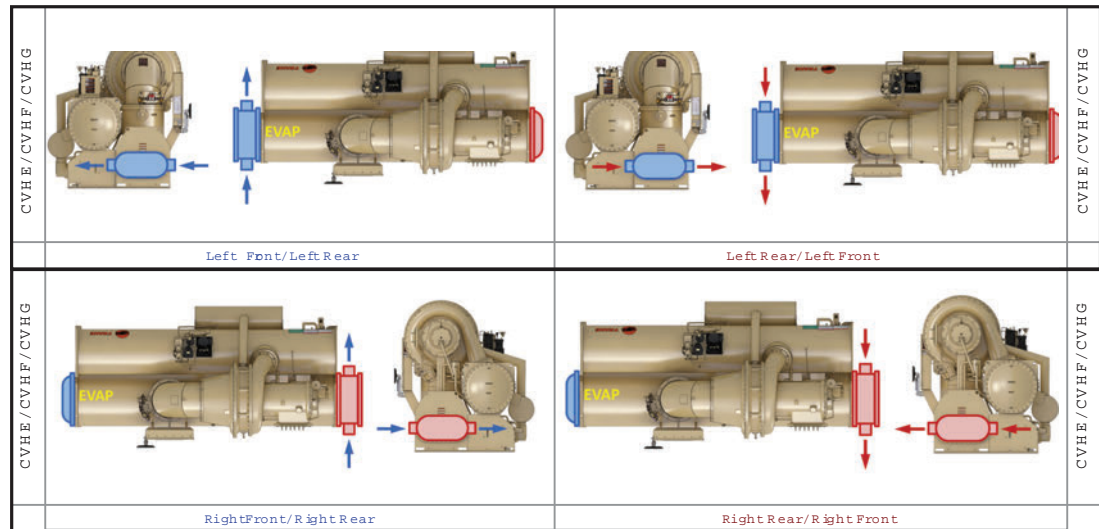


Figure 29. Two-pass marine evaporator waterbox configurations



## Appendix B: Evaporator Waterbox Configuration

Figure 30. One-pass or three-pass marine evaporator waterbox configurations

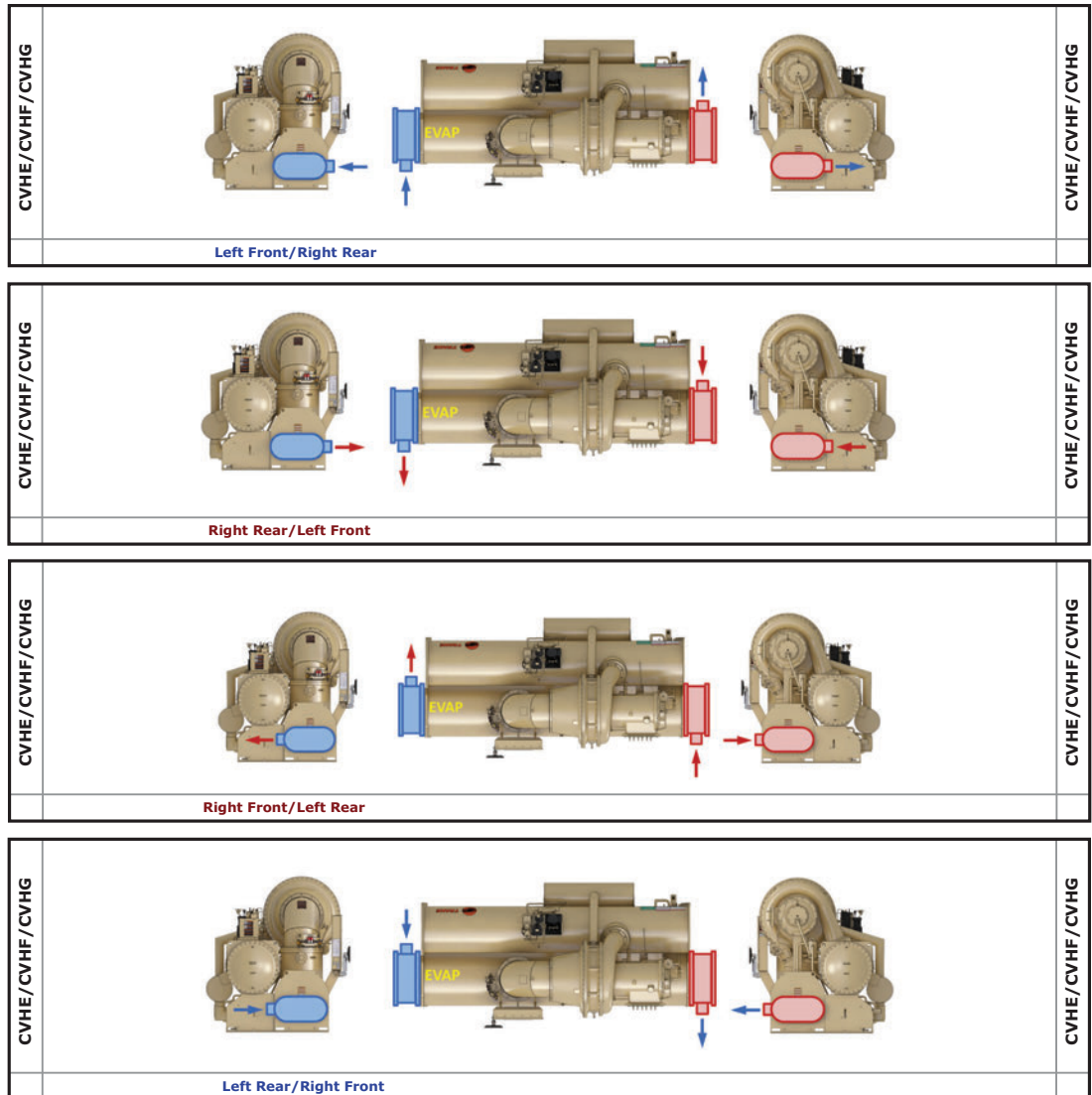
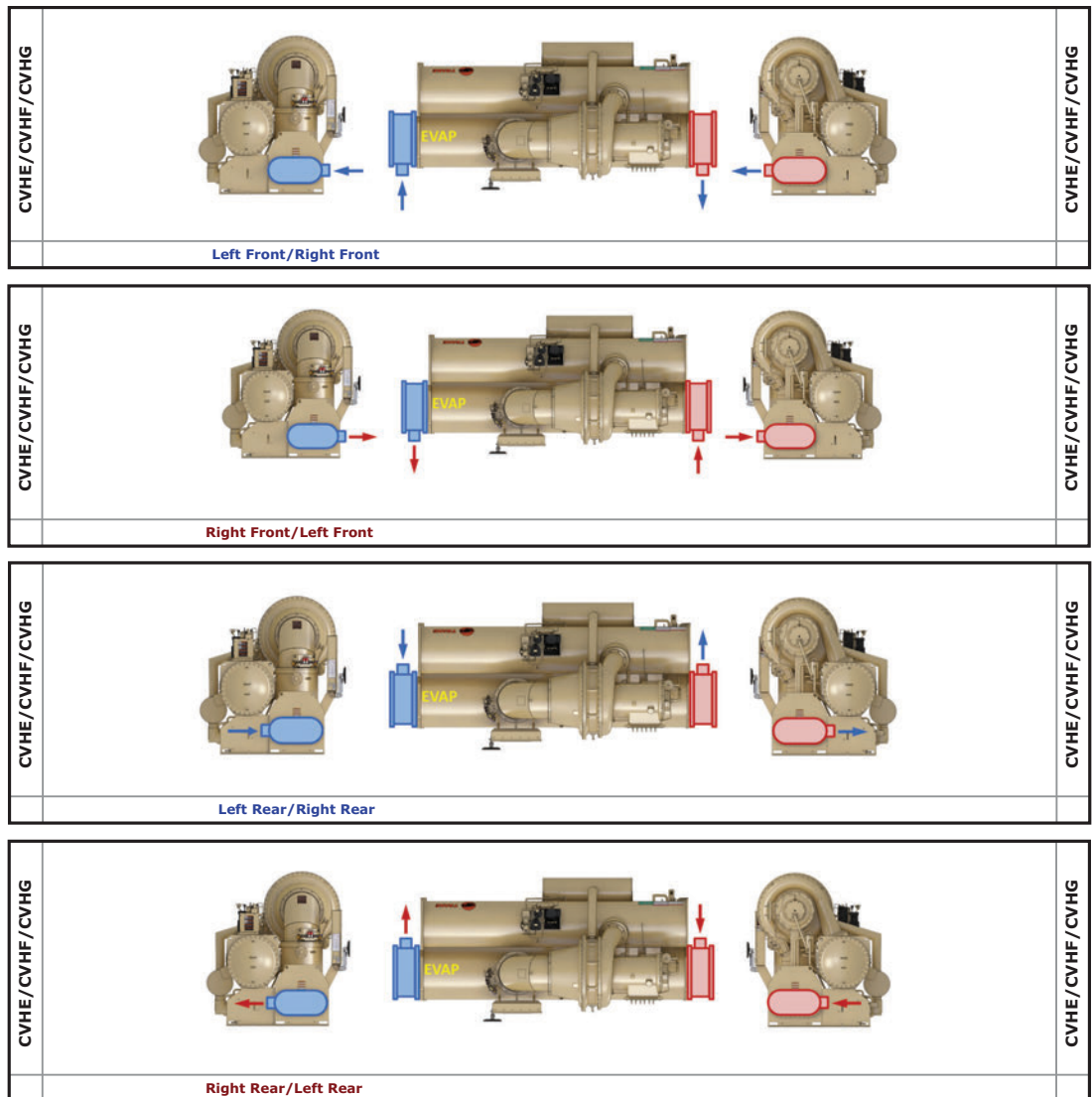


Figure 31. One-pass only marine evaporator waterbox configurations

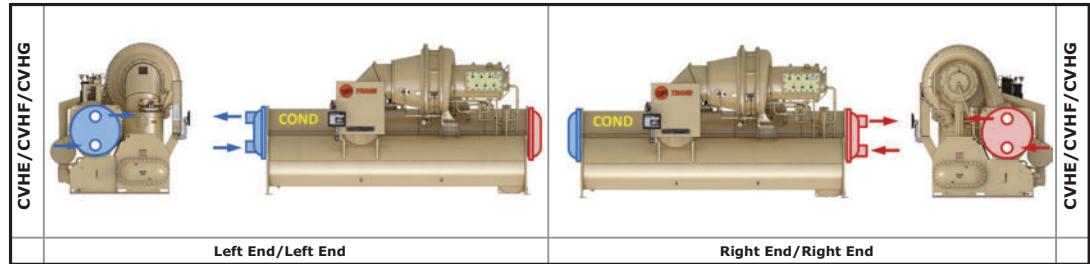


# Appendix C: Condenser Waterbox Configuration

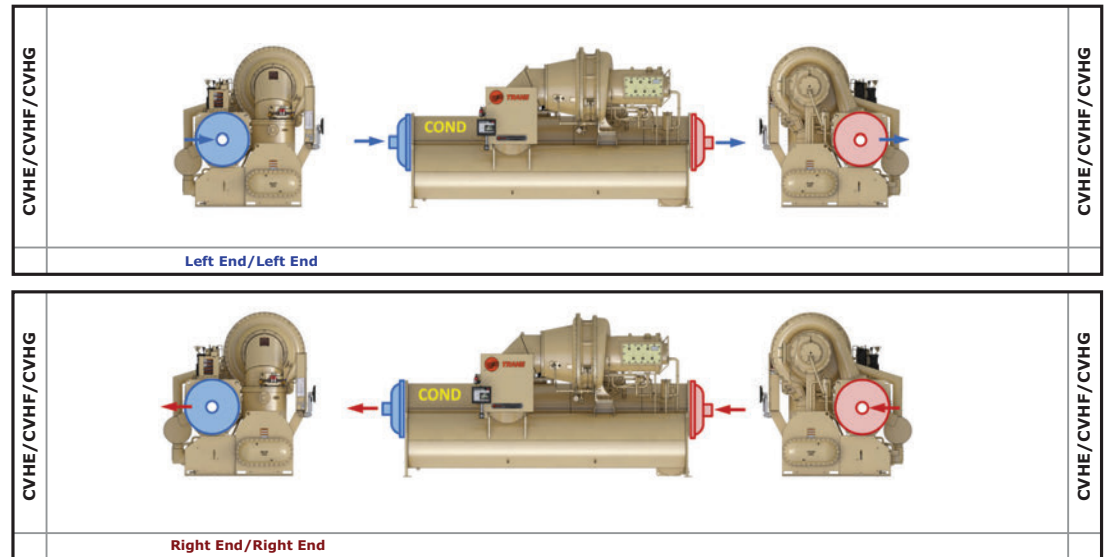
**Notes:**

- The following figures are intended to help you visualize the possible connections and combinations that may be available for your unit. You must contact your local Trane account manager to configure your selection for an as-built drawing to confirm it is available and to provide appropriate dimensions.
- Condenser waterbox arrangements for models CDHH and CVHH differ from other CenTraVac™ chillers. Please contact your local Trane account manager for more information.

**Figure 32. Two-pass non-marine condenser waterbox configurations**



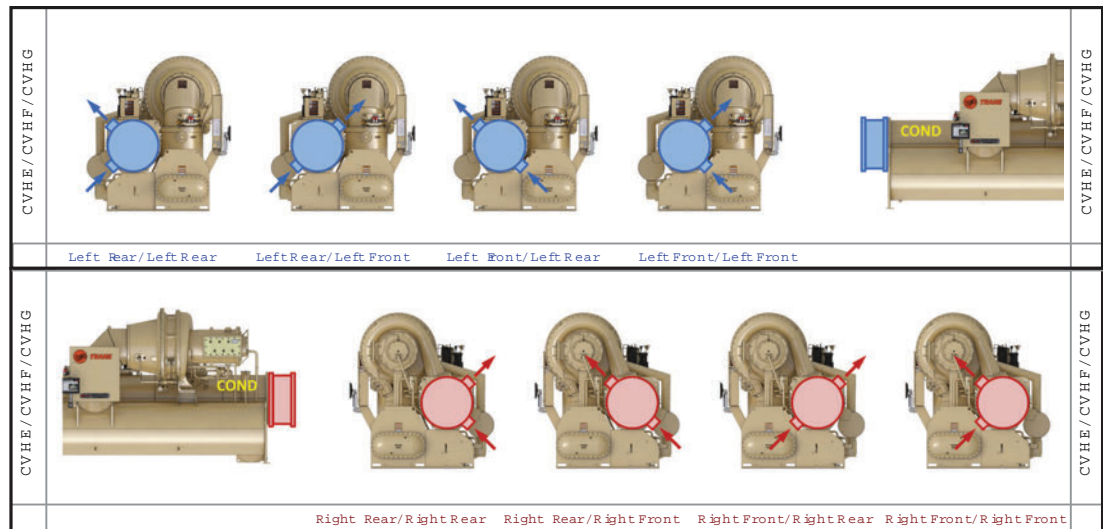
**Figure 33. One-pass non-marine condenser waterbox configurations**



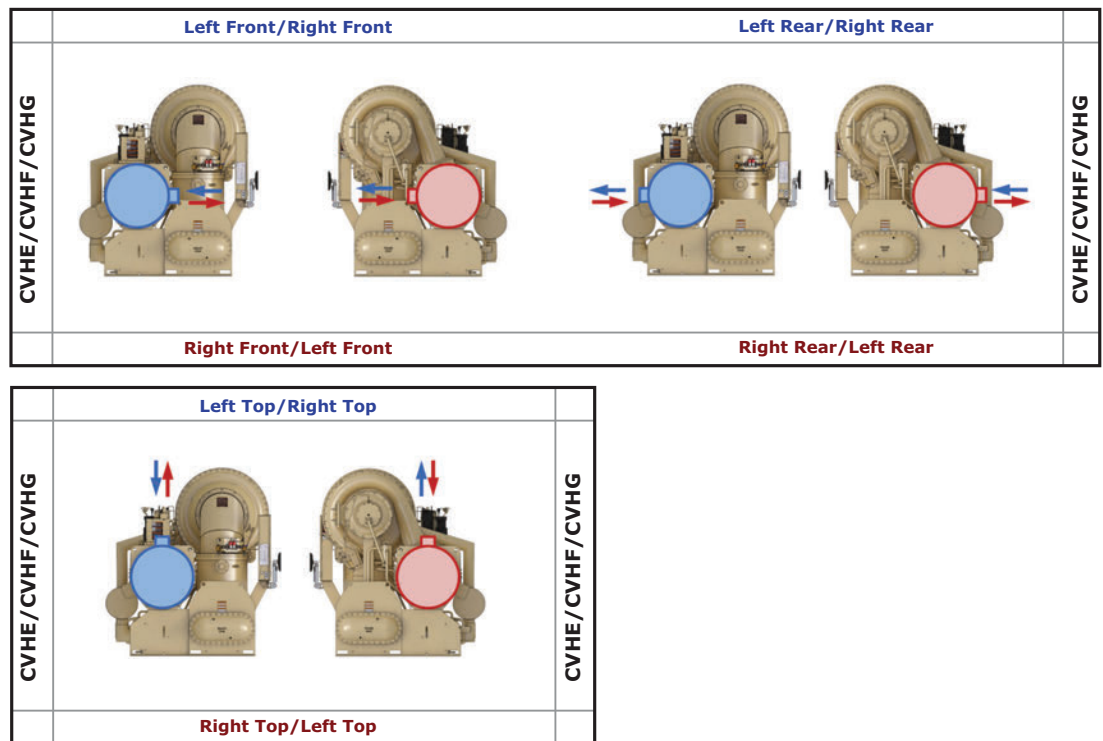


## Appendix C: Condenser Waterbox Configuration

**Figure 34. Two-pass marine condenser waterbox configurations**



**Figure 35. One-pass marine condenser waterbox configurations**





## Appendix D: Marine Waterbox Arrangement

**Table 50. Evaporator waterbox arrangement—CDHF, CDHG, CVHE, CVHF, and CVHG chillers**

EVWA	Inlet	Outlet
LFRF	LH Front	RH Front
RFLF	RH Front	LH Front
LRRR	LH Rear	RH Rear
RRLR	RH Rear	LH Rear
LFRR	LH Front	RH Rear
RFLR	RH Front	LH Rear
LRRF	LH Rear	RH Front
RRLF	RH Rear	LH Front

*Note: Data based on looking at unit on control panel side.*

**Table 51. Condenser waterbox arrangement—CDHF, CDHG, CVHE, CVHF, and CVHG chillers**

CDWA	Inlet	Outlet
LFRF	LH Front	RH Front
RFLF	RH Front	LH Front
LRRR	LH Rear	RH Rear
RRLR	RH Rear	LH Rear
LTRT	LH Top	RH Top
RTL T	RH Top	LH Top
LBRB	LH Bottom	RH Bottom
RBLB	RH Bottom	LH Bottom
LFRR	LH Front	RH Rear
LFRT	LH Front	RH Top
LFRB	LH Front	RH Bottom
RFLR	RH Front	LH Rear
RFLT	RH Front	LH Top
RFLB	RH Front	LH Bottom
LRRF	LH Rear	RH Front
LRRT	LH Rear	RH Top
LRRB	LH Rear	RH Bottom
RRLF	RH Rear	LH Front
RRLT	RH Rear	LH Top
RRLB	RH Rear	LH Bottom
LTRF	LH Top	RH Front
LTRR	LH Top	RH Rear
LTRB	LH Top	RH Bottom
RTLF	RH Top	LH Front
RTL R	RH Top	LH Rear
RTL B	RH Top	LH Bottom
LBRF	LH Bottom	RH Front
LBRR	LH Bottom	RH Rear
LBRT	LH Bottom	RH Top
RBLF	RH Bottom	LH Front

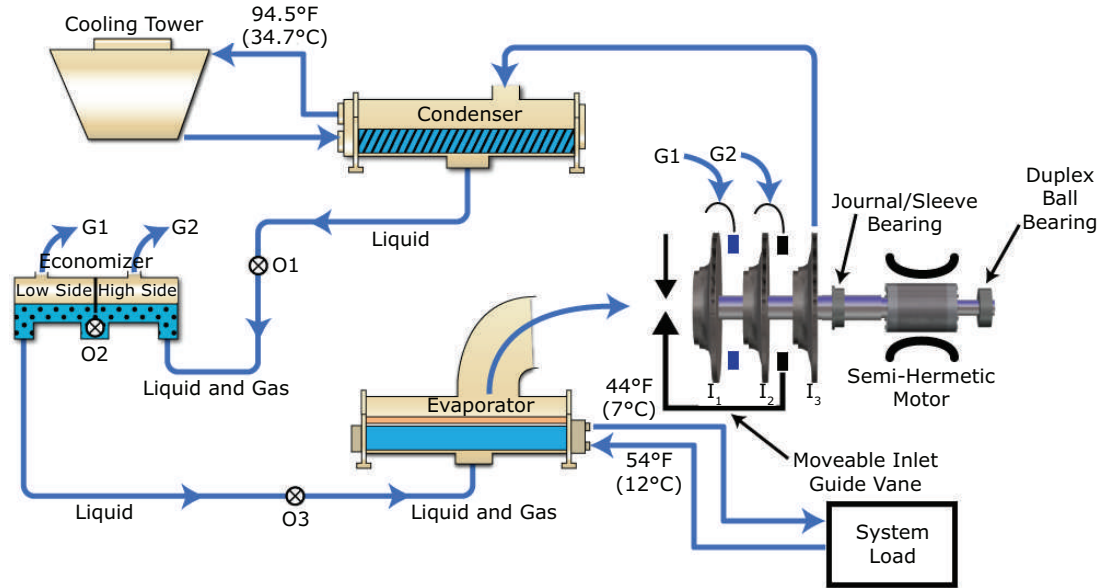
**Table 51. Condenser waterbox arrangement—CDHF, CDHG, CVHE, CVHF, and CVHG chillers (continued)**

CDWA	Inlet	Outlet
RBLR	RH Bottom	LH Rear
RBLT	RH Bottom	LH Top

*Note: Data based on looking at unit on control panel side.*

# Appendix E: CenTraVac Chiller Operating Cycles

**Figure 36. Three-stage refrigerant flow (models CVHE, CVHG, and 50 Hz CVHH)**



**Notes:**

1. For two-stage refrigerant flow (models CVHF and 60 Hz CVHH), remove the third impeller (I3) and orifice (O2) to yield a single phase economizer (G1 only).
2. Model CVHH utilizes a hydrodynamic bearing instead of a duplex ball bearing.

## Compressor Motor

All CenTraVac™ chiller motors are cooled by liquid refrigerant surrounding the motor windings and rotor. Using liquid refrigerant results in uniform low temperatures throughout the motor, which prolongs motor life over open designs. Motor heat is rejected out to the cooling tower, which helps keep the equipment room at a desirable temperature.

**Induction**—A specially designed squirrel-cage, two-pole motor suitable for 60 or 50 Hz, three-phase current.

## Fixed Orifice Flow Control

For proper refrigerant flow control at all load conditions, the CenTraVac™ chiller design incorporates the Trane® patented fixed orifice system. The orifices are optimized for full- and part-load chiller performance during the selection process. It eliminates float valves, thermal expansion valves, and other moving parts. Since there are no moving parts, reliability is increased.

## Low Speed, Direct Drive Compressor

The direct drive, low speed compressor with a motor shaft supported by only two bearings provides quiet, reliable and more efficient operation.

With only one primary rotating component—the rotor/impeller assembly—the CenTraVac™ chiller is inherently quieter than gear-driven compressors. Typical CenTraVac™ chiller sound measurements are among the quietest in the industry. Trane can guarantee sound levels with factory testing and measurements in accordance with AHRI Standard 1280.

Compressors using gears suffer mesh losses and extra bearing losses in the range of three to five percent at full load. Since these losses are fairly constant over the load range, increasingly larger losses (as a percentage) result as the load decreases.

## Multiple Stages of Compression

The multi-stage design provides a stable operating envelope to meet dynamic system needs for reliable operation in all real-world conditions. It also enables the use of a flash economizer for better efficiency.

## Inlet Guide Vanes

Part-load performance is further improved through the use of moveable inlet guide vanes. Inlet guide vanes improve performance by throttling refrigerant gas flow to exactly meet part-load requirements and by pre-rotating the refrigerant gas. Pre-rotation minimizes turbulence and increases efficiency.

## Flash Economizer

CenTraVac™ chillers leverage a multi-stage design with two or three impellers, making it possible to flash refrigerant gas at intermediate pressure(s) between the condenser and evaporator, significantly increasing chiller efficiency.

- Two-stage CenTraVac™ chillers (60 Hz models CDHF, CDHH, CVHF, and CVHH) utilize a single-stage economizer, providing up to 4.5 percent better efficiency than designs with no economizer.
- Three-stage CenTraVac™ chillers (60/50 Hz model CVHE and 50 Hz models CDHG, CDHH, CVHG, and CVHH) utilize a two-stage economizer, providing up to 7 percent better efficiency than designs with no economizer.

These improvements in efficiency are not possible in single-stage chillers where all compression is done by one impeller.

## Refrigerant/Oil Pump Motor

Models CDHF, CDHG, CVHE, CVHF, and CVHG: The oil pump motor is a 120 volt, 60/50 Hz, 3/4 hp, 1-phase motor with protective fusing and panel mounted contactor.

Models CDHH and CVHH: Low voltage chillers will have a 200–240V 60/50 Hz, 1-phase, 2 hp motor.

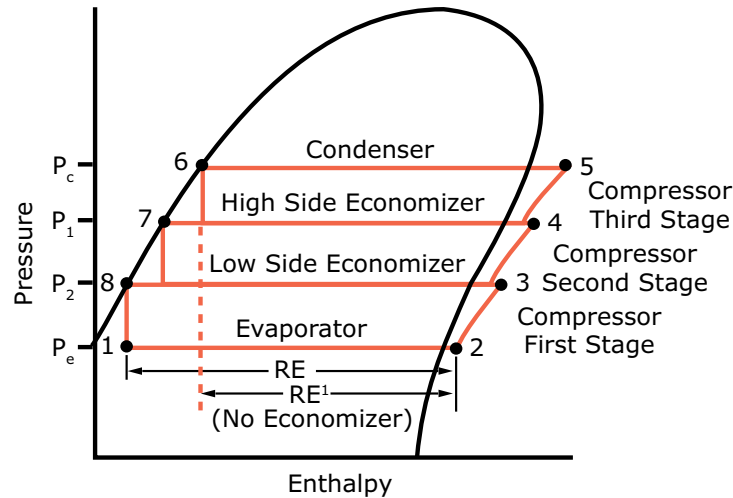
## Purge System

The purge design features a high-efficiency carbon filter with an automatic regeneration cycle. The filter separates refrigerant from non-condensable gas and collects it. When the filter senses that it is full, the regeneration cycle begins, and reclaimed refrigerant is automatically returned to the chiller. This keeps the purge efficiency at its peak without the need to exchange carbon canisters.

Operating efficiency meets ASHRAE Standard 147 and does not exceed 1 units of refrigerant lost per unit of dry air removed.

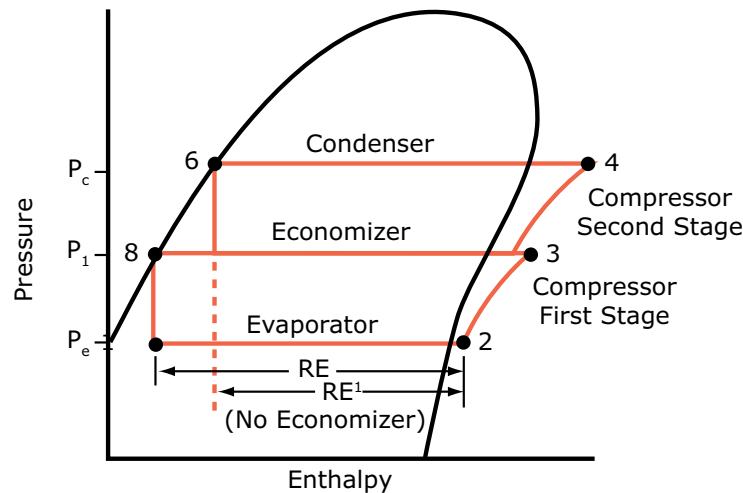
# Appendix F: CenTraVac Chiller Pressure-Enthalpy (P-H) Diagrams

Figure 37. Three-stage CenTraVac chiller P-H diagram



Note: RE = Refrigeration Effect

Figure 38. Two-stage CenTraVac chiller P-H diagram



Note: RE = Refrigeration Effect

The pressure-enthalpy (P-H) diagrams describe refrigerant flow through the major chiller components. The diagrams confirm the superior cycle efficiency of the multi-stage CenTraVac™ compressor with economizer.

**Evaporator**—A liquid-gas refrigerant mixture enters the evaporator (*point 1*). Liquid refrigerant is vaporized (*point 2*) as it absorbs heat from the system cooling load. The vaporized refrigerant then flows into the compressor's first stage.

**Compressor First Stage**—Refrigerant gas is drawn from the evaporator into the compressor. The first-stage impeller accelerates the gas, increasing its temperature and pressure into the first stage of the compressor (*point 3*).

**Compressor Second Stage**—Refrigerant gas leaving the first stage of the compressor is mixed with cooler refrigerant gas from the low pressure side of the economizer. This mixing lowers the enthalpy of

## Appendix F: CenTraVac Chiller Pressure-Enthalpy (P-H) Diagrams

the mixture entering the second stage. The second-stage impeller accelerates the gas, further increasing its temperature and pressure (*point 4*).

**Compressor Third Stage**—For CenTraVac™ chillers with three-stage compressors, the refrigerant gas leaving the compressor's second stage is mixed with cooler refrigerant gas from the high pressure side of the two-stage economizer. This mixing lowers the enthalpy of the gas mixture entering the third stage of the compressor. The third-stage impeller accelerates the gas, further increasing its temperature and pressure (*point 5*), then discharges it to the condenser.

**Condenser**—Refrigerant gas enters the condenser where the system cooling load and heat of compression are rejected to the condenser water circuit. This heat rejection cools and condenses the refrigerant gas to a liquid (*point 6*).

For **three-stage** CenTraVac™ chillers with the patented two-stage economizer and refrigerant orifice system, liquid refrigerant leaving the condenser (*point 6*) flows through the first orifice and enters the high pressure side of the economizer. The purpose of this orifice and economizer is to pre-flash a small amount of refrigerant at an intermediate pressure (P1). Pre-flashing some liquid refrigerant cools the remaining liquid (*point 7*). Refrigerant leaving the first stage economizer flows through the second orifice and enters the second-stage economizer. Some refrigerant is pre-flashed at an intermediate pressure (P2). Pre-flashing the liquid refrigerant cools the remaining liquid (*point 8*).

For **two-stage** CenTraVac™ chillers with economizer and refrigerant orifice system, liquid refrigerant leaving the condenser (*point 6*) flows through the first orifice system and enters the economizer. The purpose of the orifice and economizer is to pre-flash a small amount of refrigerant at an intermediate pressure (P1) between the evaporator and condenser. Pre-flashing some liquid refrigerant cools the remaining liquid (*point 8*).

Another benefit of flashing refrigerant is to increase the total evaporator refrigeration effect from RE<sup>1</sup> to RE; refer to "Flash Economizer," p. 109.

To complete the operating cycle, liquid refrigerant leaving the economizer (*point 8*) flows through a second orifice system. Here, refrigerant pressure and temperature are reduced to evaporator conditions (*point 1*).

The pressure enthalpy (P-H) diagrams show refrigerant flow through the major chiller components. The diagrams confirm the superior cycle efficiency of the multi-stage Agility compressor with economizer.

**Evaporator** — A liquid gas refrigerant mixture enters the evaporator (*point 9*). Liquid refrigerant is vaporized (*point 1*) as it absorbs heat from the system cooling load. The vaporized refrigerant then flows into the compressor's first stage.

**Compressor First Stage** — Refrigerant gas is drawn from the evaporator into the compressor. The first stage impeller accelerates the gas, increasing its temperature and pressure into the first state of the compressor (*point 2*).

**Compressor Second Stage** — Refrigerant gas leaving the first stage of the compressor is mixed with cooler refrigerant gas from the secondary side of the brazed plate heat exchanger economizer (*point 7*). This mixing lowers the enthalpy of the mixture entering the second stage. The second stage impeller accelerates the gas, further increasing its temperature and pressure (*point 3*).

**Condenser** — Refrigerant gas enters the condenser where the system cooling load and heat of compression are rejected to the condenser water circuit. This heat rejection cools and condenses the refrigerant gas to a liquid (*point 4*). The liquid refrigerant flows through an internal subcooler, where additional energy in the refrigerant liquid passes into the condenser water circuit (*point 5*).

**Economizer** — The liquid refrigerant is split such that the primary flow is directed through one side of the brazed plate heat exchanger economizer, while a significantly smaller portion of the flow passes through an expansion valve, lowering refrigerant pressure and temperature before entering phase refrigerant (*point 6*). The heat transfer between the primary and secondary channels in the BPHE results in further subcooling of the primary liquid (*point 8*) as it rejects heat to, and consequently superheats, the secondary flow. The additional subcooling of the liquid prior to expansion through the main electronically controlled valve (*point 9*) effectively increases the overall capacity of the evaporator.



# Appendix G: Standard Conversions

To Convert From:	To:	Multiply By:
<b>Length</b>		
Feet (ft)	meters (m)	0.30481
Inches (in.)	millimeters (mm)	25.4
<b>Area</b>		
Square feet (ft <sup>2</sup> )	square meters (m <sup>2</sup> )	0.093
Square inches (in. <sup>2</sup> )	square millimeters (mm <sup>2</sup> )	645.2
<b>Volume</b>		
Cubic feet (ft <sup>3</sup> )	cubic meters (m <sup>3</sup> )	0.0283
Cubic inches (in. <sup>3</sup> )	cubic mm (mm <sup>3</sup> )	16387
Gallons (gal)	liters (L)	3.785
Gallons (gal)	cubic meters (m <sup>3</sup> )	0.003785
<b>Flow</b>		
Cubic feet/min (cfm)	cubic meters/second (m <sup>3</sup> /s)	0.000472
Cubic feet/min (cfm)	cubic meters/hr (m <sup>3</sup> /h)	1.69884
Gallons/minute (gpm)	cubic meters/hr (m <sup>3</sup> /h)	0.2271
Gallons/minute (gpm)	liters/second (L/s)	0.06308
<b>Velocity</b>		
Feet per minute (fpm)	meters per second (m/s)	0.00508
Feet per second (fps)	meters per second (m/s)	0.3048
<b>Energy, Power, and Capacity</b>		
British thermal units per hour (Btu/h)	kilowatt (kW)	0.000293
British thermal units per hour (Btu)	kilocalorie (kcal)	0.252
Tons (refrig. effect)	kilowatt (refrig. effect)	3.516
Tons (refrig. effect)	kilocalories per hour (kcal/hr)	3024
Horsepower	kilowatt (kW)	0.7457
<b>Pressure</b>		
Feet of water (ft H <sub>2</sub> O)	pascals (Pa)	2990
Inches of water (in. H <sub>2</sub> O)	pascals (Pa)	249
Pounds per square inch (psi)	pascals (Pa)	6895
Pounds per square inch (psi)	bar or kg/cm <sup>2</sup>	6.895 x 10 <sup>-2</sup>
<b>Weight</b>		
Ounces	kilograms (kg)	0.02835
Pounds (lb)	kilograms (kg)	0.4536
<b>Fouling factors for heat exchangers</b>		
0.00085 ft <sup>2</sup> ·°F·h/Btu	= 0.132 m <sup>2</sup> ·°K/kW	
0.00025 ft <sup>2</sup> ·°F·h/Btu	= 0.044 m <sup>2</sup> ·°K/kW	

## Temperature Conversions

Scale		Temperature			Temperature Interval	
		°C	°F		°C	°F
Celsius	x°C =	x	1.8x + 32	1°C =	1	9/5 = 1.8
Fahrenheit	x°F =	(x-32) / 1.8	x	1°F =	5/9	1







Notes

---





The AHRI Certified mark indicates Trane U.S. Inc. participation in the AHRI Certification program. For verification of individual certified products, go to [ahridirectory.org](http://ahridirectory.org).

Trane - by Trane Technologies (NYSE: TT), a global innovator - creates comfortable, energy efficient indoor environments for commercial and residential applications. For more information, please visit [trane.com](http://trane.com) or [tranetechnologies.com](http://tranetechnologies.com).

Trane has a policy of continuous product and product data improvements and reserves the right to change design and specifications without notice. We are committed to using environmentally conscious print practices.