



Product Catalog

Performance Climate Changer™

Air Handlers

Model CSAA





Introduction

Performance Climate Changer™ air handlers combine the Trane tradition of engineering excellence with the latest in manufacturing technology to give you an energy efficient air handler with superior performance, the highest quality and reliability, and the lowest installed cost in the industry. This air handler was designed to incorporate such features as component flexibility, integrated control options, and proven performance to give you the optimal system to clean, filter, dehumidify, heat, and cool your building.

Superior Performance

- ASHRAE 111 Class 6 low-leak casing design
- Less than L/240 @ +/- 8-inches w.g. panel and door deflection
- 2-inch R13 foam-insulated, mid-span thermal break panels and thermal break doors
- Casing thermal resistance ratio TR-value of 0.6

Industry-Leading Energy Efficiency

- AMCA 611-certified Traq™ airflow monitoring station
- Economizer section meets or exceeds all mandatory requirements prescribed by California Building Energy Efficiency Standard Title 24
- Total energy-recovery wheels
- Cool Dry Quiet (CDQ™) desiccant dehumidification wheels
- Discharge plenums and plenum fan sections available with variable size, type, and location of openings to reduce static pressure loss and lower energy consumption
- 25,000 hour LED service lights
- Low-leak, high thermal performance casing design
- All airfoil-bladed and Traq dampers meet ASHRAE 90.1 lowest specified leakage requirements
- High-efficiency coil fins deliver superior heat transfer while allowing face velocities in excess of 625 fpm without moisture carryover
- Variable Refrigerant Flow (VRF) split systems with Trane air handlers allow for heat pump operation
- Variable Refrigerant Flow (VRF) systems with Trane air handlers allow for heat recovery in buildings that require simultaneous heating and cooling

System Optimization

- Optimal design to meet the Trane EarthWise™ design philosophy incorporating high-efficiency air handlers and water chillers with low flow rates and low temperatures
- Factory-engineered, -mounted, -tested, and programmed control packages with properly sealed casing openings.
- Variety of coil types with high-efficiency coil fins allow lower coil approach temperature and reduce chance of moisture carryover
- Ability to choose the exact number of fins per foot of coil surface to enhance heat transfer and air pressure performance
- Wide array of fan options including motorized impellers, direct-drive plenum fans
- Control options to easily incorporate fan pressurization and demand control ventilation strategies.
- Design and analysis tools provide whole building analysis, acoustical design guidance, equipment performance data, and suggested control strategies to help achieve optimum system design with tailored energy, IAQ, and project budget solutions
- Integration into Variable Refrigerant Flow (VRF) systems with matched coil selections for use with Linear Expansion Valve (LEV) kits for trouble free configurations

Highest Quality

- UL/CUL listed
- AHRI Standard 430-certified air-handling unit

- AHRI Standard 410-certified coils are all factory tested
- AHRI Standard 1060-certified energy wheels
- All fans are dynamically balanced in the horizontal and vertical planes
- All fans with VFDs undergo inverter balancing
- Formulated panels and integral base frame minimize seams that could introduce air leak paths
- Integrated raceway for wiring protection
- Integrated, fully-enclosed control panel for starters, VFDs, and unit-mounted controllers
- Pre-engineered, factory-mounted controls, including end devices, motor controllers, VFDs, unit-mounted DDC controllers, Traq damper ventilation control section, UL-listed turnkey control packages

Lowest Installed Cost

- Lifting lugs included on the integral base frame
- Indoor units ship with skid designed for forklift transport
- Variable height, size, type, and location of openings on discharge plenums minimize duct transitions
- Factory-installed interoperable controls shorten construction cycles, simplify job-site coordination, reduce installation time and expense, and provide single-source responsibility for warranty and service issues
- Single-point power is available with high-voltage distribution block
- External service module with 15 amp GFCI receptacle, light switch
- Controller display and communications port
- Quick-connect wiring minimizes installation costs and provides wiring integrity between sections
- Factory-installed conduit connectors eliminate penetrations in the wrong location
- Motor leads can be run through flexible metal conduits to external motor junction box.
- Building Information Modeling (BIM) drawings to minimize jobsite ductwork, electrical, piping and structural interference
- Duct supports designed into factory roof curbs for pre-connection of ductwork

Copyright

This document and the information in it are the property of Trane, and may not be used or reproduced in whole or in part without written permission. Trane reserves the right to revise this publication at any time, and to make changes to its content without obligation to notify any person of such revision or change.

Trademarks

All trademarks referenced in this document are the trademarks of their respective owners.

Revision History

Updated seismic information.



Table of Contents

Features and Benefits	8
Form, Function and Flexibility	8
Construction and Integrity	9
Engineered for Good IAQ	9
Sound-Sensitive Solutions	10
Increase Operating Efficiency	10
Turnkey Control Solutions	11
Proven Performance	13
Leak Detection System	14
HVAC Design Fundamentals	15
Provide Proper Ventilation	15
Maintain Building Pressure	15
Protect Coils from Freezing	16
Filter Contaminants	17
Minimize Microbial Growth	19
Provide Quiet Comfort	20
Application Considerations	22
Air Handler Design	22
Standard AHU Arrangements	24
Arrangements for Specific Applications	26
Energy Recovery	32
Variable Refrigerant Flow (VRF) Systems	35
Acoustics	35
A2L Application Considerations	36
Leak Detection System (R-454B charge greater than 3.91 lb per circuit or R-32 charge greater than 4.04 lb per circuit)	37

Components and Options	38
Access/Blank/Turning Section	38
Blender	38
CDQ™ Desiccant Dehumidification Wheel	38
Coils	40
Dampers	42
Diffuser	43
Discharge Plenum	44
Energy Recovery	44
Fans	45
Filtration and Air Cleaning	47
Gas Heat	48
Humidifier	49
Inlet Hood	49
Mixing Box	50
Silencers	50
General Data	51
Unit Size 3	51
Unit Size 4	52
Unit Size 6	53
Unit Size 8	54
Unit Size 10	56
Unit Size 12	57
Unit Size 14	58
Unit Size 17	59
Unit Size 21	60
Unit Size 25	62
Unit Size 30	63
Unit Size 35	65
Unit Size 40	66
Unit Size 50	67
Unit Size 57	68
Unit Size 66	69
Unit Size 80	71
Unit Size 100	72
Unit Size 120	73



Table of Contents

Coils	75
Coil Depth	75
Coil Connections	75
Coil Circuiting	82
Face-Velocity Limits for Moisture Carryover	88
Performance Data	92
Air-to-Air Plate Frame Heat Exchangers	92
Blenders	93
Dampers	94
Diffuser	103
Discharge Plenums	104
Electric Heat - Draw Through	105
Filters	105
Hoods	108
Humidifiers	110
Silencers	111
Trane Commercial Air Purification System (TCAPS)	111
Electrical Data	112

Mechanical Specifications	114
Certifications	114
Unit Construction	114
Insulation	115
Drain Pans	115
Access Doors	115
Marine Lights	116
Fans	116
Fan Isolation	117
Fan Motors	117
Fan Section Options	117
Fan Modulation	118
Coils	118
Dampers	121
Energy Recovery Wheel Section	121
Cool Dry Quiet (CDQ™) Desiccant Wheel	122
Humidifiers	122
Filters and Air Cleaners	123
Filter Section Options	124
Mixing Section	125
Drum and Tube Gas Heat	125
Inshot Gas Heat	126
Air-to-Air Plate Frame Heat Exchanger	126
Paint Options	126
Pipe Cabinet	127
Outdoor Unit Roof	127
Silencers	127
Other Sections and Options	127
Controls	128
Ultraviolet (UV-C) Lights	130
Leak Detection Sensors	131



Features and Benefits

Figure 1. Trane performance climate changer air handler

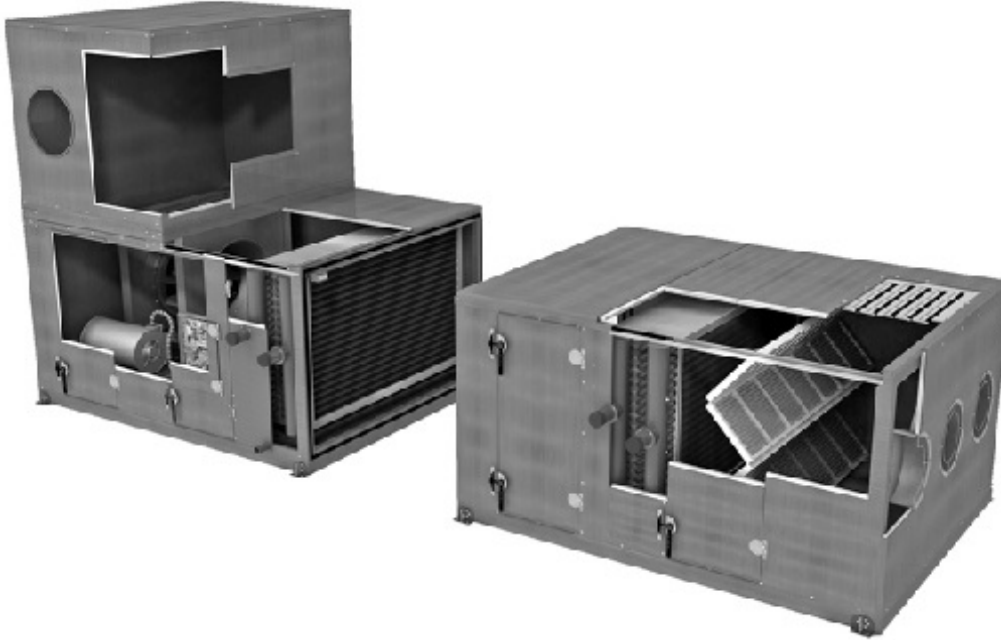

Form, Function and Flexibility

Flexibility and versatility are standard in the Performance air handler. As a semi-custom cataloged air handler, standard components can be arranged to meet most commercial, institutional and industrial applications for the indoor air handler market. Pre-engineered custom options expand that flexibility while ensuring proven, tested performance and dependability, and reducing the costs and long lead times associated with most custom units. Some projects call for an air handler that incorporates new, emerging technologies or a job-specific requirement. Trane’s experienced team of professionals can tailor the Performance air handler to meet these requirements.

The Performance CSAA air handler design adopts a “building-block” approach that allows you to design a unit specifically for your project. Choose the “blocks” you need from the wide range of standard and custom-engineered sections, and arrange them to satisfy the air-handling requirements of the application.

Reduces Footprint when Stacked

The Performance CSAA air handler design makes it easy to stack sections - even coil sections. Reducing the unit footprint is very advantageous, especially in tight mechanical rooms or limited roof space. The structural integrity remains intact, even when panels are removed for service or maintenance activities.

Eases Retrofit, Renovation, and Replacement

Buildings age, usage changes, loads change, new technology emerges, codes and standards are revised. Change is inevitable. The Performance air handler readily lends itself to the special needs of the renovation, retrofit, and replacement markets. The Performance air handler can be shipped in small segments that can easily be moved into tight spaces of existing buildings.

Standard Airside Options

Many standard options are available for specific applications, including:

- Exhaust and return fan economizers
- Direct space pressurization control
- Thermal break double-wall access doors
- Thermal break casing
- Factory-mounted, programmed, and run-tested controls
- Versatile access section lengths to meet specific needs
- Full compliment of pre- and final filter sections
- Single-point power
- LED service lights
- Variable sizes, types and opening locations for discharge plenums, plenum fans, and mixing boxes
- Variable height vertical discharge plenums
- Variable length horizontal discharge plenums
- Leak Detection Sensor for all R-454B or R-32 coils
- Multiple base frame heights/multiple curb heights
- Single-handle, multiple latch doors
- External motor junction box
- Low-flow Traq dampers for separate minimum outside air and economizing measurement/control
- Silencers
- Gas heat
- Flush-mounted dial-type filter gauge
- Stainless steel inner liners
- Treadplate floor
- Plenum fan arrays
- Factory mounted VFD per fan
- Backdraft dampers
- Piezo ring included on fans

Construction and Integrity

Trane engineered panels (walls, roof and base) and doors incorporate mid-span, internal thermal breaks to eliminate thermal conduction paths from the interior of the air handler to the exterior. Likewise, door frames also feature thermal breaks to minimizing heat transfer.

The panels and doors are designed to provide extraordinary insulating capabilities for efficient and cost effective performance. Panels are formulated with interlocking seam features and integral gasket seals optimized to drive down casing air leakage. The Performance air handler design is capable of meeting an ASHARE 111 Class 6 leakage level, better than most custom designs, up to +/-8-inches w.g. based on unit selection. Standard double-wall panels and doors include two-inch injected foam insulation providing a minimum R-value of 13, in addition to unsurpassed panel strength and L/240 deflection at +/- 8-inches w.g.

The no-through-metal panel design and low casing air leakage delivers thermal performance that assures condensation will not form on the casing exterior even under 55°F supply air temperature and design conditions on the unit exterior of 81°F dry bulb and 73°F wet bulb. In addition to the low air leakage, these standard features prevent equipment from unnecessarily creating slip hazards in the mechanical equipment room or premature corrosion of the casing. With this level of casing performance and thorough testing of Trane engineers, Trane is able to deliver predictable thermal performance and key guidance to consulting engineers.

Heavy-duty door handles and hinges are surface-mounted, eliminating a potential leakage path since they do not pierce the casing. A removable hinge pin allows for easy door removal; the symmetrical handle and hinge mounting allows for easy field modification if it becomes necessary to change from a left-hand to a right-hand door.

Engineered for Good IAQ

The building industry is continuously evolving and the rate of change is accelerating. The Performance air handler is engineered to address today's multifaceted design issues required to provide good indoor air quality (IAQ). Building owners must give particular attention to maintaining and documenting IAQ to ensure occupant comfort and to meet industry and government regulatory standards.

In Standard 62.1, the American Society of Heating, Refrigerating, and Air Conditioning Engineers (ASHRAE) provides guidance regarding suitable outside air volume to be brought into the building, recommended air filtration, and design recommendations and procedures to control microbial growth. However, applying these principles may lead to greater energy consumption, larger and noisier units, and increased risk of coil freeze-up. The flexibility of the Performance air handler enables you to configure a unique, IAQ-ready air-handling system that can address all of these concerns.

Serviceability/Cleanability

- Full-size access doors and access sections are available for easy cleaning of internal components.



Features and Benefits

- Fully removable coil and access panels.
- Smooth, cleanable interior double-wall surfaces help improve indoor air quality.
- Coils are raised up out of the drain pan to make all coils removable from the side and provide easier access to the drain pan for cleaning.

Sound-Sensitive Solutions

Acceptable space sound levels enhance occupant comfort and productivity. However, system designs that promote good IAQ can adversely affect acoustics: unlined ductwork, air handlers with solid double-wall construction, and increased fan static pressures (resulting from the addition of energy recovery and increased filtration) can magnify the building's background noise.

Trane air handlers have unique product flexibility that allow designers to use them in many low noise criteria (NC) applications.

NC curves define not-to-exceed limits for a noise source to achieve a level of occupant acceptance. Performance air handlers can be used successfully in NC 35 offices and schools.

Accurate, Tested Sound Data

Traditionally, ASHRAE algorithms have been used to predict the sound power levels of air-handling units. Although this method is easy to do, it can be inaccurate. It can produce results that deviate from tested data by as much as ± 15 dB. For more accurate sound data, AHRI has established Standard 260, which is a method of rating sound data for ducted air-handling equipment. It is intended to be a guide for the industry, including HVAC manufacturers, engineers, installers, contractors, and consumers. AHRI Standard 260:

- Strengthens testing and calibration procedures
- Provides repeatable results
- Uses a reverberant-room approach, a mapped sound-rating concept, and reference sound-source calibration
- Is application driven
- Includes ducted outlet, ducted inlet, and casing (radiated) test configurations

It is important to note that sound data for Trane air handlers is taken per AHRI Standard 260. This sound power standard covers eight octave bands (63–8000 Hz) and is unweighted (no dB corrections). AHRI Standard 260-tested sound data can be found in Trane Select Assist.

Options to Minimize Noise

Trane air handlers have many features to optimize the source sound level for job requirements while minimizing the cost of the air handler including:

- A variety of fan types to minimize the sound generated by the fan and to optimize cost no matter the application. Other fan options to minimize sound include secondary inlet bell, optional blade counts, and coplanar separation for fan arrays.
- Double-wall perforated insulation helps attenuate high-frequency noise.
- Discharge plenums reduce turbulence and create an end reflection that dampens low-frequency sound. An additional 2-inch perforated liner option attenuates higher frequency sound.
- Turning modules used to turn the air and reduce turbulence work as effective, low-cost silencers.
- Silencers for horizontal or vertical discharge in the plenum fan section come in 3-ft. and 5-ft lengths. They are dissipative or film-lined for hospital and clean-room applications.

For more information on how to apply these options in your air handler, contact your local Trane sales representative.

Increase Operating Efficiency

The Trane EarthWise™ system is a design philosophy that uses low flow rate and low temperature on both the waterside and airside, along with high-efficiency equipment. Along with reducing emissions, it also reduces first cost, lowers operating costs, and improves the acoustical characteristics and comfort of the HVAC system. Low-temperature, low-flow systems can challenge conventional air-handling units. The flexibility of the Performance air handler makes it ideally suited for low temperature applications. In addition:

- Trane has developed a unique high-efficiency fin surface that allows face velocities in excess of 625 fpm without moisture carryover. The fins have been engineered and tested to meet these higher face velocities at a given set of design conditions. This allows you to utilize the latest in airside heat transfer to further improve the efficiency of the overall system by lowering the coil approach temperature.

- The ability to choose the exact number of fins per foot of coil surface allows heat transfer and air-pressure-drop performance to be tuned to specifically meet project needs.
- The wide array of fan options lets you choose the right fan for the application.
- Factory-engineered, -mounted, and -tested controls provide the added insurance that the airflow sensors and sequences meet your requirements.
- Further system enhancements can be made by taking advantage of the latest controls technology with fan pressurization control (required in most variable-air-volume systems per ASHRAE Standard 90.1) and/or ventilation reset of the outside air damper based upon occupancy levels in the space.

Turnkey Control Solutions

Trane offers one of the most comprehensive factory-packaged controls system available — from end devices to total system integration with industry-standard open protocols. Performance air handler control packages can be used in a stand-alone operation, or can be fully integrated into a comprehensive control system. The Trane EarthWise™ system incorporates the benefits of factory-installed controls and links the air handler to the Synchrony system controls building management system. This option is designed to lower installation costs and risk while dramatically improving the quality of the application and the performance of the air handler. The entire air handler control system is engineered, mounted, wired, and tested before leaving the factory. As a result of strict quality manufacturing methods, these control options bring consistency and reliability to the control-system package and provide single-source responsibility.

The following control devices are available as standard:

- Symbio™ 500 controller
- Variable-frequency drives (VFDs)
- Digital terminal block
- Various end device options, including:
 - Flow meter, damper actuators, control valves, low limit protection
 - Condensate overflow switch
 - Fan status switch
 - Filter status switch
 - Discharge air sensor
 - Mixed air sensor
 - Damper actuator
 - Humidity sensor
 - High/low pressure cutouts
 - Filter pressure transducer
 - Current sensor

Figure 2. Integral controls cabinet for starters, variable frequency drives, and unit controllers



Figure 3. Factory-mounting ensures quality installation, as shown with the low-limit radius bend





Features and Benefits

Single-Source Responsibility

Equipment and interoperable controls, engineered and provided by a single manufacturer, provide faster construction cycles and simplify job-site coordination efforts. This simplification reduces installation time, expense, and risk. Trane equipment and controls package provides the optimal performance when integrated in a TraneEarthwise™ system. This is a powerful system architecture that unifies Trane HVAC equipment, direct digital control, and building management into a cohesive whole with an assured source of support. This system is managed with the Tracer® SC+ building management system.

Single-Point Power

For air-handling units requiring a supply fan with a return/exhaust fan, electric heat, gas heat energy recovery wheel or CDQ, we can supply single-point power. From a single line voltage connection, power is provided to all components including controls and service lights. Single-point power wiring does not compromise the UL or ETL certification of the unit.

Reduced Installation Costs

While the air-handling system is in the factory, trained technicians install the control end devices and controllers using state-of-the-art equipment and agency-approved wiring practices. The system is pre-designed, pre-engineered, and checked out, making jobsite installation and commissioning fast and easy.

While many of these tasks and procedures could be done in the field, it is beneficial to do them in the factory due to time and accessibility constraints. As a result, field expenses for installation costs of conduit and wire are minimized, additional lead-time is alleviated, and jobsite coordination is simplified. Casing integrity is also maintained by minimized penetrations.

Factory wiring minimizes installation costs, too. Quick-connect wiring ensures integrity between sections without having to identify or check continuity.

After installation, Tracer controllers enable information-sharing and complex control strategies, such as ventilation reset, throughout the HVAC system. They also ensure that each subsystem operates in the most efficient manner possible while continuing to satisfy current loads. The result is reduced building energy consumption through effective operation of the entire HVAC system at part-load conditions.

Trane ICS incorporates the latest energy-saving concepts to produce comfort at the lowest possible cost. In addition, it offers sophisticated building management features, such as after-hours billing, for commercial properties. This revenue opportunity enables developers and owners to accurately monitor and bill the cost incurred by a single tenant in after-hours usage of a facility. An optional DDC variable-air-volume (VAV) capability helps to accurately control each tenant space so that only an individual tenant's HVAC systems are activated. This helps minimize operating costs while providing flexible work hours.

Reliable Operation

Controller end devices, such as low-limit switches and averaging temperature sensors, are properly sized, selected, laboratory-tested, and mounted for optimal system performance. Trane engineers its unit-mounted controllers to provide the highest level of useful information possible. A computer-based test station tests low-voltage end-device functionality and surveys the input devices. This procedure ensures trouble-free installation and reliable operation when the Performance air handler reaches the job site. This feature can limit the number of call-backs and punch-list tasks.

Incorporating a Performance air handler with Trane ICS provides an engineered system of proven components and comfort concepts that is both state-of-the-art and reliable. Standard components are used to aid in serviceability and uniformity from building to building. These components, when tied to a Tracer Summit system, provide a powerful tool for scheduling preventive maintenance, reducing equipment downtime, and controlling service expense.

Open Protocol

Symbio™ uses open standard protocols for easy integration into building automation and HVAC systems. Available protocols are BACnet®, Modbus™, or LonTalk®. BACnet/IP is available, if required by IT.

Service Module

Figure 4. Service module



Performance air handlers can be equipped with an easy access Service Module when service lights are factory mounted. All service lights are wired to a common switch within the Service Module, located on the supply fan. The Service Module can also include a 15-amp ground-fault circuit interrupter (GFCI) receptacle separate from the load side of the equipment, a National Electrical Code (NEC) requirement.

Digital Terminal Block

The digital terminal block, a factory-installed option, connects control end devices to a Symbio™ controller. The Symbio controller includes predefined factory points but without the full Symbio package's programming logic. This enables BACnet® integration with other Trane or third-party controllers, facilitating data communication from factory-installed devices to the building automation system (BAS).

Proven Performance

AHRI Standards

Trane combines comprehensive performance certification by AHRI with thorough laboratory testing and advanced manufacturing methods. Together, these elements help assure that each Trane air handler operates predictably and reliably throughout the life of the unit.

Unlike other rating methods that check fan performance alone, Trane units are performance-tested in accordance with AHRI Standard 430. This certification process evaluates the air handler on the basis of airflow, static pressure, fan speed, and brake horsepower.

Heating and cooling coils are rigorously tested and certified with AHRI Standard 410 to assure that they, too, deliver published performance.

Trane energy wheels and air-to-air plate frame heat exchangers are certified in accordance with AHRI Standard 1060.

AHRI Standard 260 is the first ducted air handler sound rating procedure. It is intended to provide engineers with better, more accurate, ducted sound power levels so that they can design quieter and more cost-effective comfort systems. Sound ratings for Trane air handlers have been developed from extensive AHRI Standard 260 testing and laboratory data.

Miami/Dade County Notice of Compliance (NOA)

Performance Climate Changer air handlers size 3-35 are approved and have been designed to comply with the High Velocity Hurricane Zone of the Florida Building Code. Each qualified unit shall bear a permanent label with the Trane name and logo and the statement "Miami-Dade County Product Control Approved". Notice of compliance and additional product construction details can be found at the Miami-Dade County, Building Code Compliance Office Web site.

UL Listing

Trane air handlers are UL-listed to U.S. and Canadian safety standards.

IBC Seismic Certification

Air handling equipment manufactured by Trane is capable of structurally and operationally withstanding the seismic response criteria as required by the International Building Codes (IBC) 2003, 2006, 2009, 2012, 2015, 2018, 2021, and 2024. Trane has third-party certification for IBC compliance for seismic applications for unit sizes 3-120.



Features and Benefits

AMCA Certification

Trane utilizes AMCA certification for airflow measuring stations. Trane certifies that the Traq™ damper shown herein is licensed to bear the AMCA Seal. The ratings shown are based on tests and procedures performed in accordance with AMCA Publication 611 and comply with the requirements of the AMCA Certified Ratings Program.

This certification program provides the engineer and owner assurance that manufacturer-published performance ratings for airflow measurement stations are accurate and repeatable. Trane Traq dampers are certified with the integral ventilation control module (VCM) which converts differential pressure to an electronic signal for control.

Canadian Registration Number (CRN)

Air handling equipment manufactured by Trane is capable of structurally and operationally withstanding the seismic response criteria as required by the International Building Codes (IBC) 2003, 2006, 2009, 2012, 2015, 2018, 2021, and 2024 to the . Trane has third-party certification for IBC compliance for seismic applications for unit sizes 3-30. Certification for larger sizes is in process.

Leak Detection System

The Leak Detection System (LDS) consists of one or more refrigerant detection sensors and is required in ducted HVAC systems that have more than 3.91 lbs of A2L refrigerant charge, per safety standard UL 60335-2-40. For any units with more than 3.91 lbs of charge in a circuit, an LDS will be factory-installed.

Table 1. Leak detection system features

Features	Additional Details
Leak Detection Sensor per safety standard UL 60335-2-40	<ul style="list-style-type: none"> • Monitors for leaks and activates mitigation when necessary. • Reduces the risk of improper installation in the field. • Bypasses the added cost of field installation.
Leak Detection Sequence of Operation Factory Programmed in Symbio 500	Provides factory programming of leak detection, reducing risk of improper programming
Leak Detection Sequence of Operation Field Programmed on Field Installed Unit Controls	If factory installed controls are not selected or if digital terminal block is selected, the leak detection sequence of operation must be programmed by controls contractor.

HVAC Design Fundamentals

In essence, an air-handling unit, or AHU, is exactly what its name implies: a device that “handles” (moves and/or conditions) air. It accomplishes this based on the functions required by a given application, as well as the arrangement of components necessary for those functions.

Trane air handlers can accommodate an extraordinary degree of design versatility, but in order to apply that versatility to each unique application, an HVAC designer must:

- Design the air handler in a manner consistent with good HVAC design practices.
- Understand the impact of ASHRAE Standard 62.1, *Ventilation for Acceptable Indoor Air Quality*, and ASHRAE Standard 90.1, *Energy Standard for Buildings Except Low-Rise Residential Buildings*, on AHU functions and design.
- Know how specific components can address application requirements, with arrangements optimized for job requirements, thermal performance, and acoustical performance.
- Deliver the performance you have designed with a well-functioning control system.

Provide Proper Ventilation

Ventilation is the process of diluting the build-up of contaminants by introducing clean, fresh outdoor air into buildings. The lack of proper ventilation is identified as a leading cause of poor indoor air quality (IAQ) problems. ASHRAE Standard 62.1 sets the minimum ventilation rates and specifies basic HVAC equipment and system requirements to provide “acceptable indoor air quality.” ASHRAE Standard 62.1 is considered the standard of care for designers to assure good IAQ in commercial buildings.

Assuring proper ventilation levels at all operating conditions can be challenging for a designer. Fixed outdoor-air damper arrangements on variable-air-volume systems can result in severe under-ventilation of the occupied spaces at part-load conditions. The Performance air handler is available with the patented Traq™ outdoor airflow measurement and control damper, which can precisely control the volume of ventilation air entering the system and even dynamically vary the amount in response to specific operating conditions. With the Traq damper, the amount of outdoor air can be continuously logged using a Tracer® SC+ building automation system to document proper ventilation.

Maintain Building Pressure

An important aspect of establishing outdoor-air requirements is equalizing outdoor-air and exhaust-air volumes to maintain proper building pressurization. *Building pressurization* describes an air-handling strategy that regulates pressure differences across the building envelope and between zones or rooms by adjusting the amount of air that is supplied and removed.

Figure 5. Maintain proper building pressurization

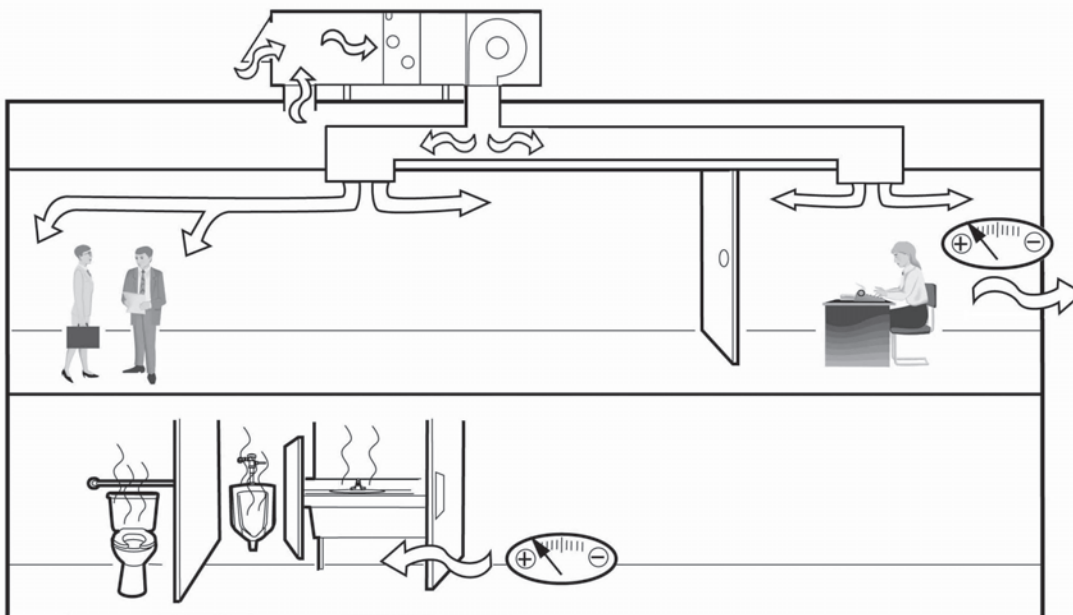

The goals of this strategy are to:

- Assure proper distribution of conditioned and ventilation air throughout the occupied space
- Avoid discomfort due to temperature stratification and drafts
- Prevent infiltration of unconditioned air
- Confine odors and contaminants to specific areas within the building

Building-envelope pressurization is typically achieved by incorporating either an exhaust fan and economizer or a return fan and economizer in the air handler design. Careful analysis is required to determine which approach best suits the unique requirements of each application. To better understand the differences between exhaust-fan and return-fan systems, consult your local Trane sales representative or see the *Building Pressurization Control Applications Engineering Manual* (AM-CON-17*-EN).

Protect Coils from Freezing

Figure 6. Protect coils from freezing by addressing air stratification

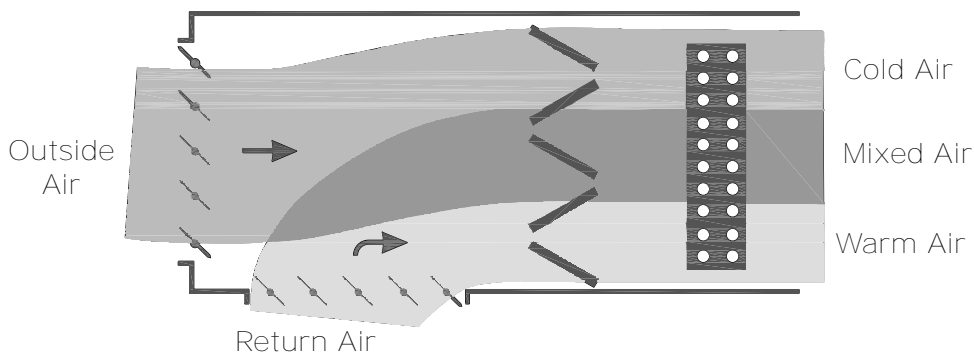

When bringing more outdoor air into the air handler to satisfy the ventilation requirements of ASHRAE Standard 62.1, it increases the likelihood of air stratification. If a layer of freezing air moves through the air handler, it can damage unprotected, hydronic cooling and heating coils.

Figure 7. Low-limit sensor

Traditional freeze protection includes a low-limit thermostat, installed on the face of the cooling coil, that trips when it detects a dangerously low air temperature. When this happens, it stops the supply fan, closes the outdoor air damper, and ultimately degrades the building IAQ.

It is important to design the air handler so that it effectively treats the required amount of outdoor air—regardless of temperature—without risking coil damage, tripping the low-limit thermostat, or compromising indoor air quality. Trane has several means of providing coil protection. Choose the technique that best suits the application requirements.

- *Drain the coils.* This approach necessitates vent and drain connections on every coil, plus shutoff valves to isolate them from the chiller(s).
- *Add glycol and an inhibitor to the cooling system water.* The glycol lowers the water freezing point, and the inhibitor helps to resist corrosion.
- *Introduce ventilation air downstream of the cooling coil* with dual-path or bypass techniques.
- *Preheat the outdoor air stream.* Use a traditional or integral face-and-bypass steam coil or a hot hydronic coil to raise the air-stream temperature above freezing.
- Use a blender section. This approach mixes the outdoor and recirculated air streams to address air stratification.

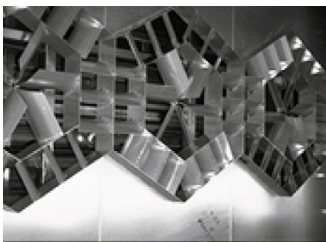
Figure 8. Blender

Filter Contaminants

Particulate Filter Guidelines

The Environmental Protection Agency (EPA) and ASHRAE recommend that the concentration of particulates in the air not exceed 0.05 mg/m^3 (measured as an annual mean). This guideline is established in an EPA PM-10 standard which focuses on smaller particulates (<10 microns) that are likely responsible for adverse health effects because of their ability to reach the lower regions of the respiratory tract.

ASHRAE Standard 62.1 and the U.S. Green Building Council LEED rating system emphasize the importance of including appropriate filters in the air handling system to effectively control particulate contaminants. Both establish minimum requirements for filter performance applied within a commercial building based on ASHRAE Standard 52.2, Method of Testing General Ventilation Air-Cleaning Devices for Removal Efficiency by Particle Size. This standard establishes a test procedure for evaluating the performance of air-cleaning devices as a function of particle size (0.3 to 10 microns). A minimum efficiency reporting value (MERV) is assigned to a filter based on its efficiency in three different particle-size ranges (0.3 to 1 microns, 1 to 3 microns, and 3 to 10 microns). A higher MERV rating indicates a greater ability to remove high quantities of small particles from air.

ASHRAE Standard 62.1 recommends a minimum MERV 6 filter, while the USGBC LEED rating system recommends a minimum MERV 8 during the construction cycle and MERV 13 during normal operation. National, state, or local codes established by government bodies or occupational groups may dictate more specific or stringent filtration requirements.

Selecting the appropriate filter relies on understanding the particles that need to be filtered and their size. The following table provides design guidance for which filter option should be applied in your air handler.

Table 2. MERV ratings versus particle size efficiencies

MERV Value	Group 1 Avg. Eff.% 0.3 to 1.0 microns	Group 2 Avg. Eff.% 1.0 to 3.0 microns	Group 3 Avg. Eff.% 3.0 to 10.0 microns	General Applications
1	—	—	E3<20	Residential Light commercial
2	—	—	E3<20	
3	—	—	E3<20	
4	—	—	E3<20	
5	—	—	20<35	Commercial Industrial Better residential
6	—	—	35<50	
7	—	—	50<70	
8	—	—	70	
9	—	E2<50	85	Commercial Telecommunications Industrial
10	—	50<65	85	
11	—	65<80	85	
12	—	80	90	
13	E1<75	90	90	Superior commercial Health care Hospitals General surgery
14	75<85	90	90	
15	85<95	90	90	
16	95	95	95	
17	99.7	—	—	Surgery Pharmaceutical manufacturing

Gases and Vapors

Figure 9. Use proper filtration

The presence of various undesirable gases and vapors (particularly formaldehyde, radon, oxidants, and volatile organic compounds, or VOCs) indoors can be detrimental to building occupants, materials, and contents. Controlling VOC concentrations is particularly challenging—hundreds of them are present, few are unique to any one source, and there are many potential sources, some of which emit several VOCs.

A common way to control gaseous contaminants is to dilute them with outdoor air. This approach is appealing because many VOCs defy individual treatment. However, it is only practical if the quality of the outdoor air is suitable *and* if the resulting supply airflow is consistent and appropriate *and* if it mixes effectively with the air in the occupied space. Another approach is to neutralize the contaminants in the air. This can be done through air cleaning mechanisms UVc/PCO technology to reduce volatile organic compounds (VOCs) through photocatalytic oxidation without the creation of ozone or by-products.

Minimize Microbial Growth

Figure 10. Keep surfaces clean



Although filtration effectively removes a number of common particulate and gaseous contaminants from the building environment, microbiological, or *microbial*, contaminants such as fungi (mold and mildew) and bacteria are sometimes too small to be filtered entirely from the air stream. To help control microbial growth, design the air handler to include:

- Non-porous, cleanable interior wet surfaces
- Easy access to all areas of the air handler for inspection, service, and cleaning
- Use of ultraviolet (UV) germicidal irradiation lights.

Regular cleaning and disinfecting with nonpolluting cleansers and antimicrobial coatings also helps, but none of these measures totally eliminates the growth of ever-present microorganisms. Consequently, moisture control becomes another important means of combating microbial contaminants.

Water Management

Cooling coils collect water from the passing air stream as they cool and dehumidify it. If not properly addressed, this condensed moisture encourages mold, mildew, and other microorganisms to colonize and breed. To reduce the likelihood of microbial growth:

- Reduce moisture carryover by sizing the cooling coils for proper airflow velocities. Trane coils can be sized for velocities in excess of 625 fpm without moisture carryover, depending on air conditions, coil size, and coil-fin type and spacing. See [“Face-Velocity Limits for Moisture Carryover,” p. 88.](#)
- Specify drain pans sloped in two planes to eliminate stagnant water conditions and to promote positive drainage.
- Locate coils on the second level of a stacked air handler to provide adequate trapping height.
- Properly size condensate traps to ensure proper drainage. See the figure below.
- Promote cleanability by providing adequate space and access around the unit.
- Easily removable access panels.
- Provide extended drain pans to allow for periodic cleaning.
- Condition the mechanical equipment room to prevent condensation on piping, ductwork, mechanical equipment, and other surfaces.

Figure 11. Drain pan trapping for positive and negative pressure applications

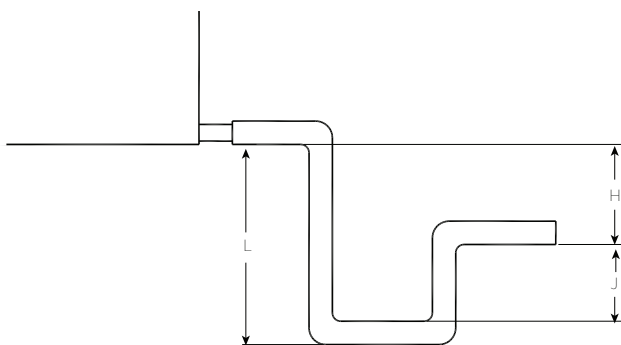

Section under negative pressure

Section under positive pressure

$L = H + J + \text{pipe diameter}$ where:
 $H = 1$ inch for each inch of negative pressure plus 1 inch with loaded filters
 $J = 1/2 H$

$L = H + J + \text{pipe diameter}$ where:
 $H = 1/2$ inch (minimum)
 $J = 1/2$ inch plus the unit positive static pressure at coil discharge (loaded filters)

Dehumidification

ASHRAE Standard 62.1 observes that “high humidities can support the growth of pathogenic or allergenic organisms” and suggests that the relative humidity of the occupied space not exceed 60 percent. Higher humidities also require lower supply-air

temperatures for thermal comfort. Most climates require dehumidification to achieve this design goal. Dehumidification can be accomplished by removing moisture from the air, that is, condensing the water vapor on cooling coils.

However, cooling coils can over cool the occupied space when dehumidifying at sensible part-load conditions. There are several ways to control to both humidity and temperature at part load conditions.

- Use a VAV air handler versus a constant volume air handler. This can improve part load dehumidification by providing relatively constant, low dew-point temperature at all load conditions.
- Use desiccant dehumidification systems to dehumidify and control humidity to very tight tolerances.
- Use a split dehumidification unit (SDU) to improve dehumidification by treating the ventilation air separately.
- Use a dedicated outside air system (DOAS) to dehumidify the ventilation air.
- Use a reheat coil, which can be accomplished using recovered condenser heat energy or with standard electric or hot water coils.

Humidification

Low relative humidity - below 30 percent - in an occupied space is also undesirable because it requires higher supply-air temperatures for thermal comfort and promotes static electricity. Raising the space humidity to an appropriate level requires a humidifier to inject water particles into the passing air stream. To avoid promoting microbial growth, the unit design must assure that the injected water is fully absorbed within the air handler *without* collecting on its walls or components.

Three types of commercial humidifiers are generally used in central-station air-handling systems: wetted media, atomized water, and steam. Of these types, ASHRAE Standard 62.1 prefers steam “as the moisture source for humidifiers.” The temperature and pressure properties of steam make it easy to introduce directly into the passing air stream and encourages complete absorption in a short distance. Trane standard humidifier sections incorporate all the distance required for absorption to occur.

- Never position the humidification section immediately downstream of a housed fan or blow-thru coil section.
- Extra dispersion distance may be needed if the humidification section is placed upstream of a final filter or electric heat coil.
- Vertical airflow turns immediately upstream and downstream of the humidification section necessitate a large section.

Provide Quiet Comfort

Figure 12. Trane acousticians collect and text sound data



Acceptable sound levels inside a building can improve occupant comfort and productivity. In fact, achieving an acceptable acoustical environment today is almost as important as simply conditioning it. To meet space sound levels, be sure to optimize the noise source (the air handler) using path attenuation (ducts, wall, and room carpeting).

The sound source can be projected using Trane Select Assist selection program. The sound path can be projected using the Trane Acoustical Program (TAP). Compare the resulting NC projection with the designed value. If the NC projection is too high, the air handler can be made quieter with a selection focused on acoustics, or the path attenuation can be increased—or both strategies can be combined. In the end, the projection should meet the NC requirements for your job.

Creating quiet spaces is increasingly difficult because of the trend toward “IAQ-hardened” systems. “IAQ hardening” involves removing fiberglass insulation, which acts as a sound absorber, from inside the ducts and even the units. Without this insulation, the air handler makes too much noise.

With Trane’s acoustic options and the Trane Select Assist selection program, you can create the unit you need for your quiet application. With these options, you can select an air handler that is more than 20 dB quieter than a conventional unit. The starting point is the Trane AHRI Standard 260 sound database.

Trane sound power ratings cover eight octave bands (63–8000 Hz). Data is collected in one of Trane’s ANSI 12.32-qualified reverberant rooms.

To determine the most cost-effective acoustical solution for a given application:

- Select the unit and predict the unit sound power using the Trane Select Assist selection program.
- Project the sound to the space using TAP.

Optimize the unit sound (fan, plenums) with the path attenuation (ductwork and ceiling) for the lowest first cost that meets the sound requirements.

The following table summarizes the noise reduction ideas accumulated by Trane engineers during four decades of experience with central-station air handlers. Use the Trane Select Assist program to predict the effect of each idea.

However, for acoustically sensitive applications, we strongly recommend that you work with your local Trane sales representative to find the most cost-effective solution that meets your job requirements.

Table 3. Noise reduction suggestions

Targeted Sound	Suggestions
Overall unit sound power (Lw)	<ul style="list-style-type: none"> • In VAV systems, use variable-frequency drives for fan modulation. • Change fan types. • Increase the fan size. • Use a central exhaust fan rather than a return fan.
Discharge sound power	<ul style="list-style-type: none"> • Use discharge plenums. • Use outlet silencers. • Use perforated walls. • Use multiple-discharge plenum outlet ducts. • Use discharge plenums with side openings.
Inlet sound power	<ul style="list-style-type: none"> • Use a large inlet plenum. • Use inlet silencers. • Stack the inlet sections.

Application Considerations

The first things to consider when selecting an air handler for any given application include:

- *Design.* Which overall system design best suits the required function?
- *Arrangements.* What is the best section arrangement for the specified function and layout?
- *Components.* Which components should be selected to support the function, layout, and arrangement of the application?

Air Handler Design

Which design best suites the application? After determining the required airflows and functions for a particular application, the HVAC designer must determine which one of two path layouts for outdoor air best serves the application: single-path or dual-path.

Single-Path Design

Single-path AHUs rely on one outdoor air path. Depending on application requirements, that path may provide ventilation air only or both ventilation air and economizing air for natural, non-mechanical cooling. Components for filtering and tempering the air are arranged in series. The single-path layout can accommodate passive or powered return- and/or exhaust-air paths as well as energy recovery.

Figure 13. Single-path design

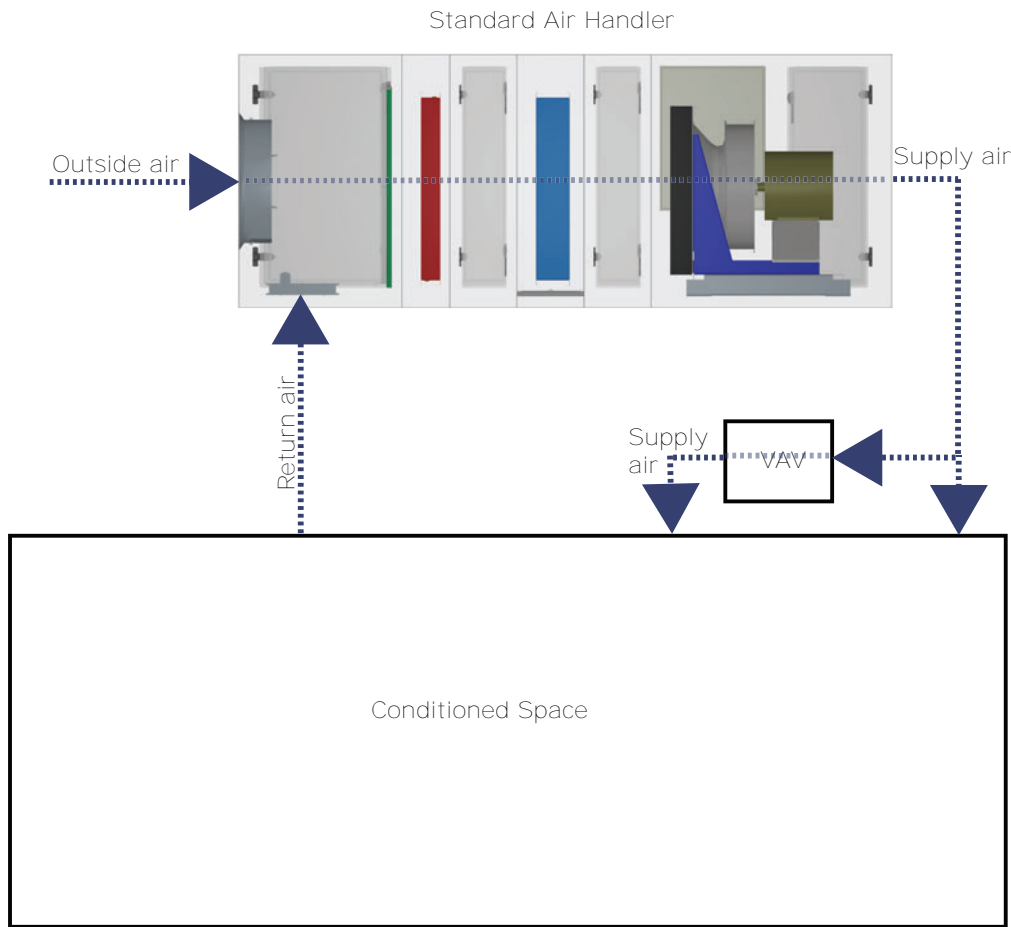

Dual-Path Design

Dual-path AHU layouts provide two air paths. Like a single-path design, dual-path designs can incorporate basic outdoor air, recirculation, exhaust-air, and energy-recovery functions. However, one path is dedicated to handling ventilation air to specifically address ASHRAE Standard 62.1 requirements.

The typical dual path air handler configuration consist of the top air path sized for the minimum ventilation requirement for the system; the bottom half of the air handler is sized for the full system flow which primarily treats the return air. The two airstreams are mixed before being delivered to the space prior to entering the supply fan. This arrangement is used for constant volume or VAV systems that at design require the supply air to be 25-50 percent outdoor air. Each path is provided with its own air treatment components such as filters and heating and cooling coils.

Figure 14. Dual-path design

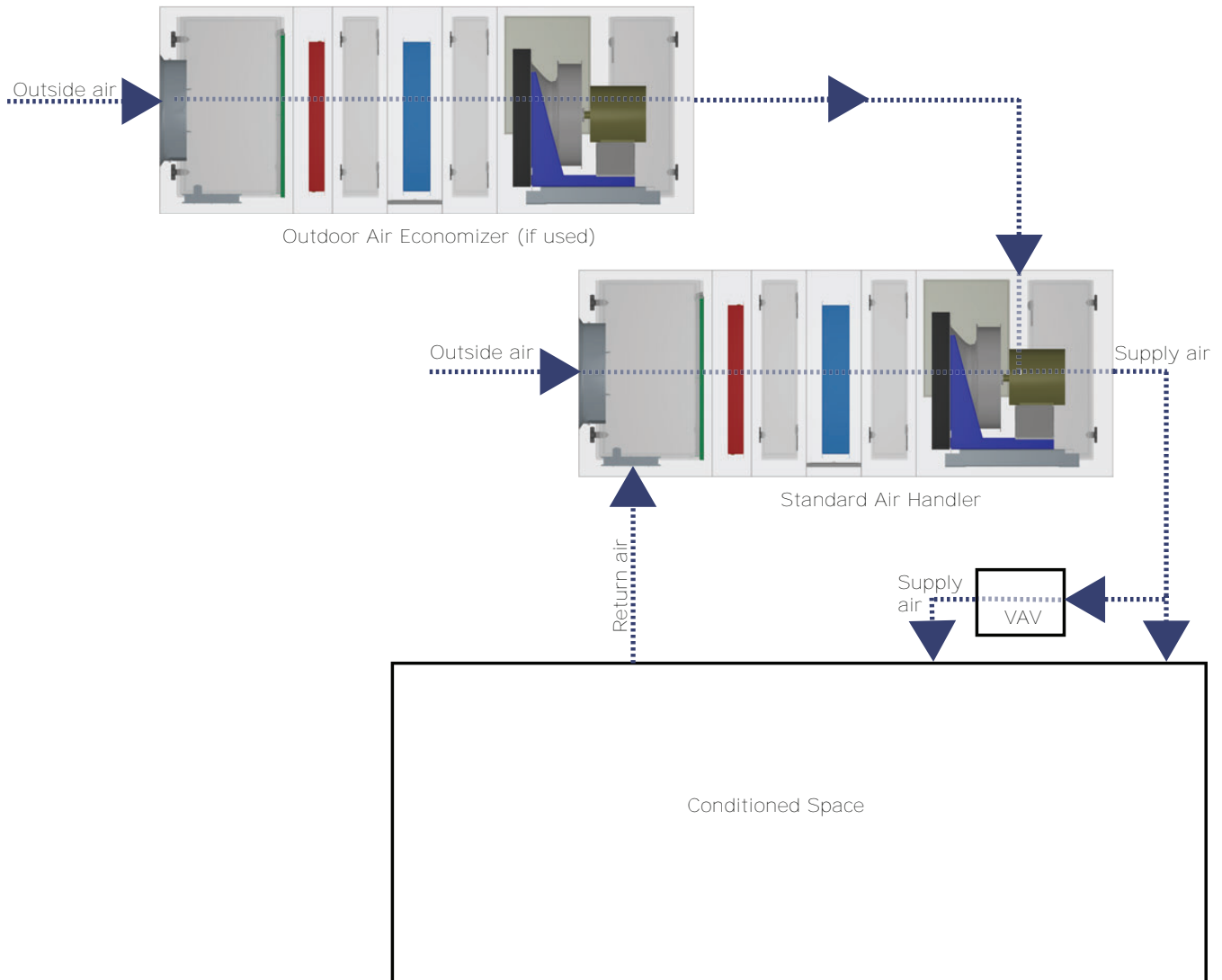

For more design options, see *Dehumidification in HVAC Systems Applications Engineering Manual* (SYS-APM004*-EN).

Application considerations:

- Reduces or eliminates reheat requirements, while providing an effective means of dehumidification for loads with low sensible-heat ratios (high latent cooling requirements)
- Avoids increasing supply-fan static pressure due to high pressure drop components in the ventilation air stream (increases latent cooling and filtration capacity without increasing fan size)
- Permits downsizing of the ventilation-path components
- Enables compliance with the ASHRAE Standard 62.1 requirement for measuring outdoor airflow without significantly increasing the first cost of the air handler
- Provides a cost-effective means to increase ventilation airflow in an existing system
- Reduces cost by reducing the number of units (dedicated outdoor-air units can be eliminated).

Standard AHU Arrangements

To complete the air-handling system, the sections must be physically arranged in a way that fits the available space. Conventional descriptions of air handler arrangements, *draw-thru* and *blow-thru*, reflect the means of establishing airflow through the coil based on the position of the coil relative to the fan: the fan either draws air through a coil located upstream or blows air through a downstream coil.

Trane adds another dimension to air handler arrangements, letting you combine sections by stacking them on top of each other in space-saving configurations, by coupling them together with transition panels, or by combining both techniques. Careful evaluation of the merits of each arrangement is a critical part of the design process.

Draw-Thru Arrangements

A draw-thru AHU arrangement places the coils and filters upstream of a ducted supply fan. It can be single- or dual-path.

Horizontal Draw-Thru

Accepted system design practices are generally the only restrictions in a horizontal draw-thru application. However, certain application rules must be followed to promote proper airflow through filters and coils.

Figure 15. Horizontal draw-thru arrangement

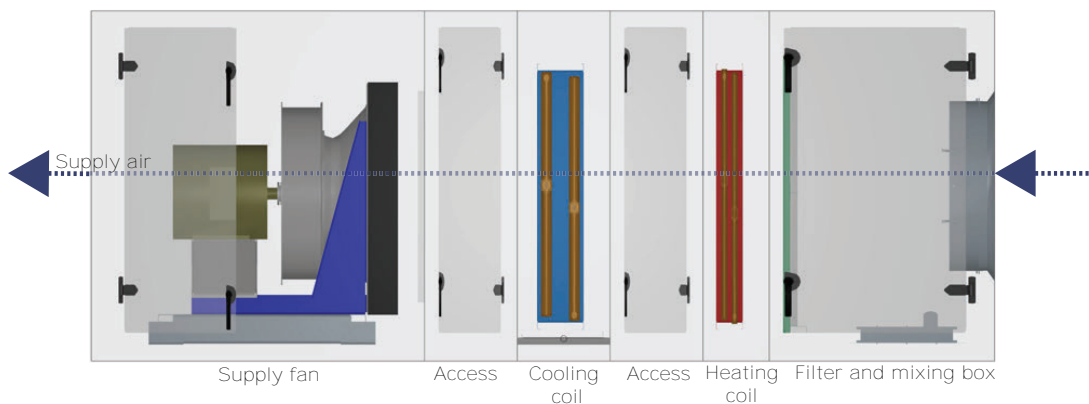

Vertical Draw-Thru

Trane air handlers in a vertical draw-thru arrangement typically result in a shorter footprint than horizontal draw-thru units. This arrangement stacks a fan on top of a vertical coil section. When designing an air handler in this configuration:

- The bottom deck must be equal to or longer than the fan section to avoid creating a “cantilever” effect.
- A vertical draw-thru fan performance curve should be used to account for the airflow impingement by a coil installed in a vertical coil section.

Figure 16. Vertical draw-thru arrangement

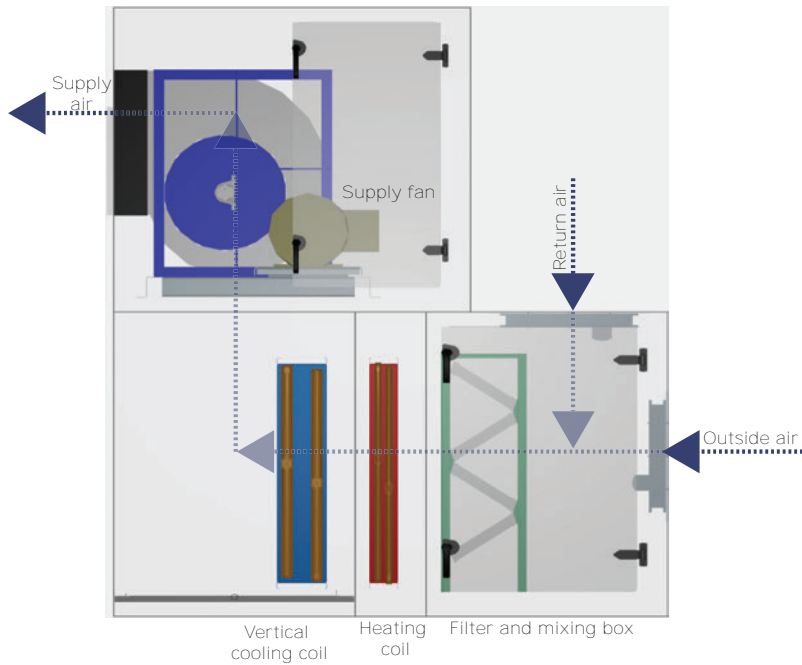

Blow-Thru Arrangements

This type of AHU arrangement places the cooling coil downstream of the supply fan.

Single-Zone Blow-Thru

This type of arrangement can provide only one supply-air temperature from the unit. To promote proper air distribution through each section and to reduce the risk of moisture carryover, certain application considerations apply based on the fan type.

Figure 17. Single-zone blow-thru arrangement

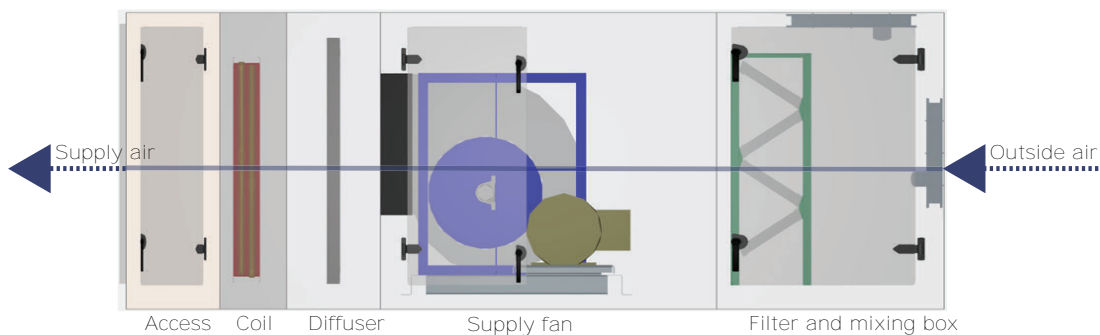

Stacked Units

A stacked AHU arrangement can be either draw-thru or blow-thru. It places the air handler sections on top of each other. This strategy can significantly reduce the length of the unit and provide better acoustical performance, yet has very little effect on unit static pressure drops.

Application considerations:

- Stacked section weight must not exceed the maximum stacking weight of the casing.
- Ductwork and dampers must not interfere with stacked sections.
- Upper-deck sections cannot overhang lower sections.
- Intermediate support brackets should be used if the width of the upper deck is less than that of the bottom deck.

Arrangements for Specific Applications

Draw-thru and blow-thru arrangements for Trane air handlers can be engineered for specific applications, including those to maintain proper building pressure, dehumidify, and recover energy.

Building Pressurization

Return fans and exhaust fans are used to maintain building pressurization. A Trane air handler can include either of these components. To better understand the differences between exhaust-fan and return-fan systems, consult your local Trane sales engineer or see the *Building Pressurization Control Applications Engineering Manual* (AM-CON-17*-EN).

Building Pressurization with Return Fan and Economizer

The following graphic depicts a standard air handler with a return fan and an economizer for outdoor air. The return fan typically runs continuously to balance the amount of air supplied to and removed from the occupied space. Although this approach makes precise space pressurization control more difficult, it is better suited to applications with high return static pressures than the exhaust-fan alternative. If the supply fan is unable to handle system static pressure, the return fan is sized to overcome the external static pressure of the return duct. Of course, the larger size and constant operation of the return fan also means higher first and operating costs.

Figure 18. Return fan and economizer arrangement for outdoor units

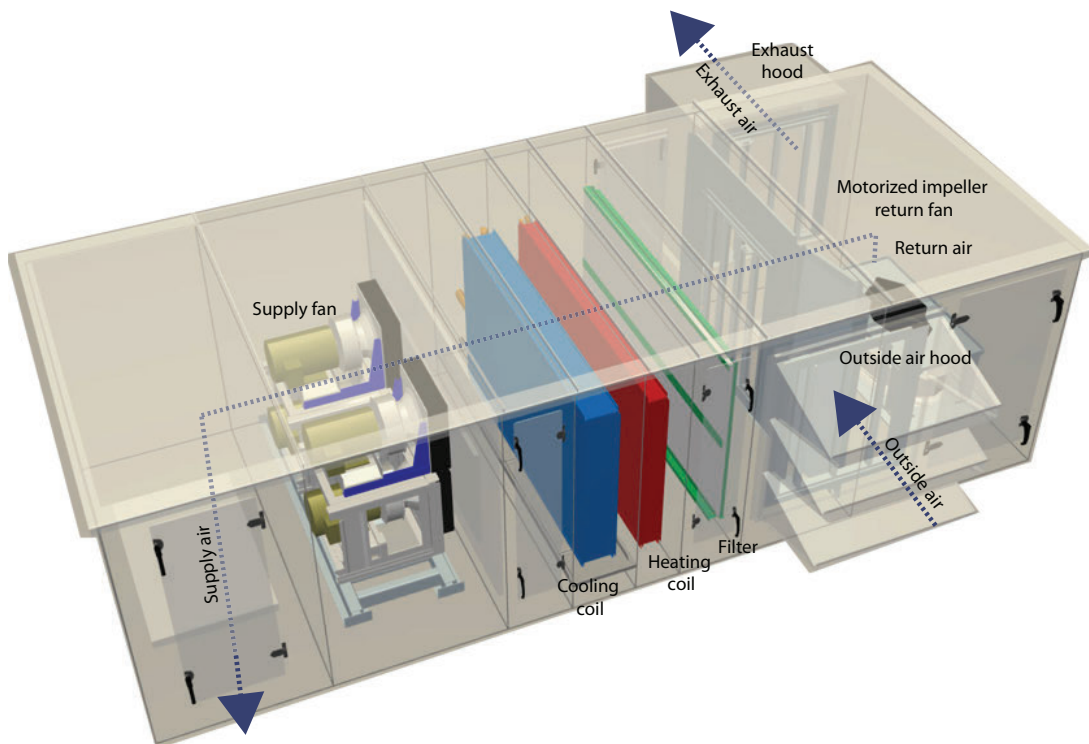

Application Considerations:

- Size the *supply fan* to handle the static pressure requirements of a 100 percent *economizer* operation, including outdoor air ductwork, dampers, filters, coils, other accessories in the outdoor airstream, and supply duct static pressure.
- Size the return fan to handle the static pressure requirements of a 100 percent *return air* operation, including return duct, exhaust duct, and exhaust damper.
- Control the return fan to keep the outdoor/indoor static pressure differential within design limits.
- Control the mixing box dampers to prevent all of them from closing simultaneously; otherwise, serious equipment damage could result.

Building Pressurization with Exhaust Fan and Economizer

The following graphic depicts a standard air handler with an exhaust fan and an economizer for outdoor air. To balance the amount of air exhausted from the building with the amount of air brought into the building, the exhaust fan modulates, running at

full capacity only when the economizer brings in 100 percent outdoor air. When the economizer is at minimum and the exhaust fan is idle, dampers on the mixing box close to prevent outdoor air from being drawn into the air handler through the exhaust section.

Figure 19. Exhaust fan and economizer arrangement

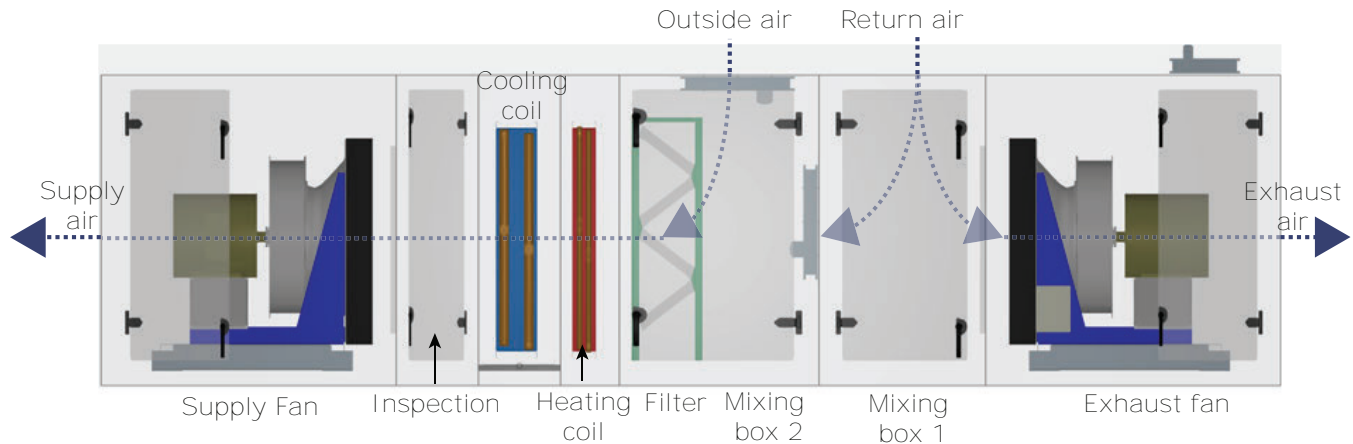

The exhaust-fan-and-economizer combination provides strict space pressurization control, provided that the supply fan is sized to handle total system static pressure. Its first cost and operating cost are usually lower than the return-fan-and-economizer alternative, too. (An exhaust fan requires less capacity than a return fan and runs less often.)

Application considerations:

- Size the *supply fan* to handle the static pressure requirements of the higher of either a 100 percent *economizer* operation or 100 percent *return-air* operation.
- Size the *exhaust fan* to handle the static pressure requirements of a 100 percent *return-air* operation, including return duct, exhaust duct, and shutoff damper, when the unit is in full economizer mode.
- Control exhaust airflow to keep the outdoor/indoor static-pressure differential within design limits.
- Control the mixing box dampers to prevent all of them from closing simultaneously; otherwise, serious equipment damage could result.

Dehumidification

Excessive humidity in buildings can encourage mold and mildew growth and thermal discomfort. To cost effectively address these issues, first isolate the conditioned space from the unconditioned space. (See the *Managing Building Moisture Applications Engineering Manual* (SYS-AM-15) Next, remove the humidity.

The two primary humidity sources in most buildings are people and outdoor air. In any coil-based HVAC system, it is the cooling coil that dehumidifies the air. This coil must be on and air must pass through it for dehumidification to occur. In Trane air handler enhanced dehumidification units, the priority for the cooling coil is humidity control. Temperature control is secondary and is generally provided by a separate reheat source.

Dehumidification can be obtained using:

- CDQ™ (Cool, Dry, Quiet) units with desiccant dehumidification wheels
- Series, coil run-around loops
- Split dehumidification units (SDU)

Free reheat options with dehumidification include:

- Hot water heat-recovery coils
- Refrigerant heat-recovery H coils
- VRF heat recovery coil

Dehumidification with CDQ™ (Cool, Dry, Quiet) Desiccant Wheels

The addition of the CDQ desiccant wheel to the system enhances the dehumidification performance of the traditional cooling coil. The CDQ wheel transfers water vapor and the cooling coil does all the dehumidification work in the system. The latent

Application Considerations

capacity of the cooling coil increases without increasing its total cooling capacity. The system can achieve a lower supply air dew point without lowering the coil temperature. Unlike a system with a cooling coil alone, the dew point of the air leaving the coil can be lower than the dry bulb temperature leaving the coil.

Figure 20. Dehumidification with CDQ (Cool, Dry, Quiet) desiccant dehumidification unit

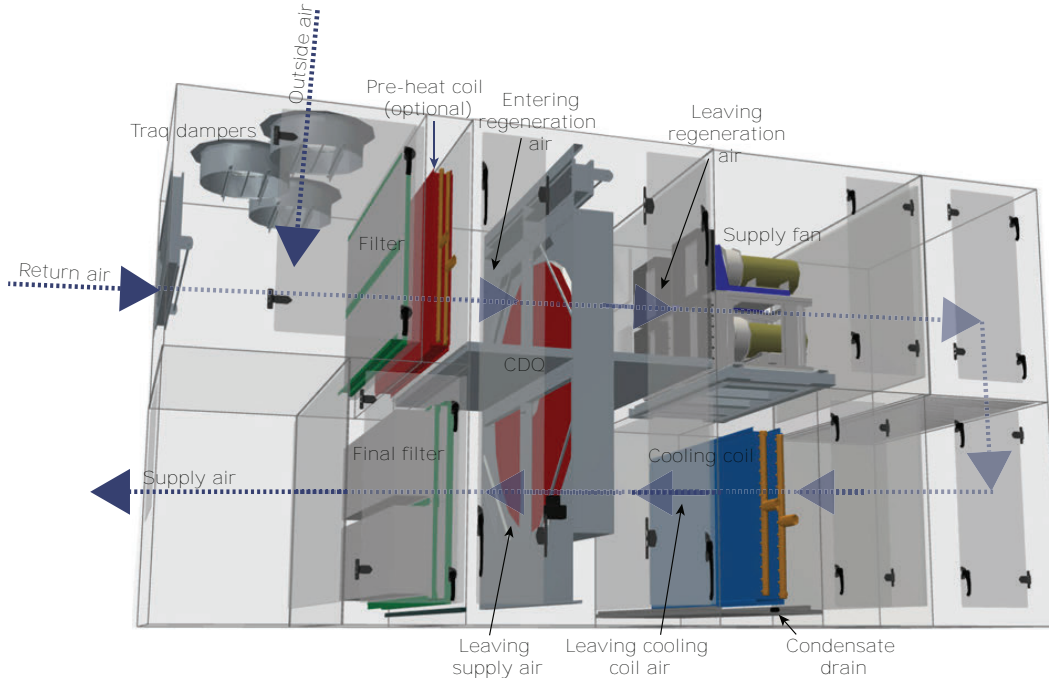
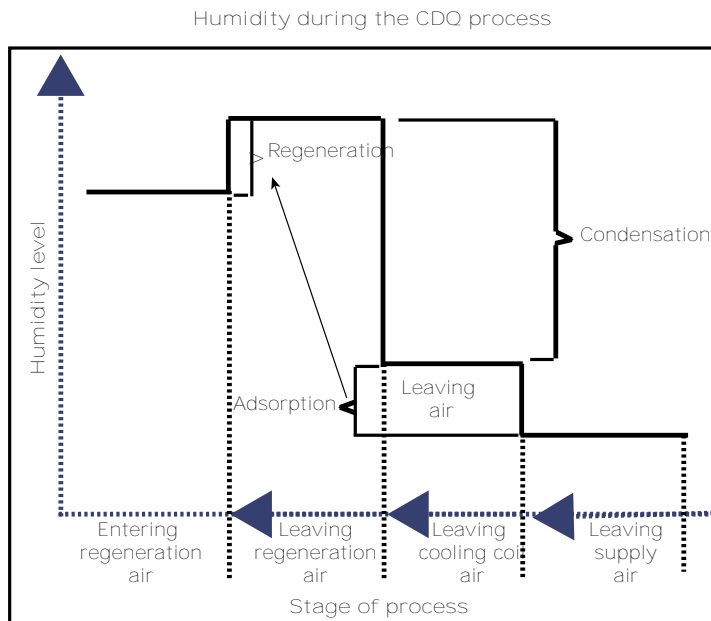

Figure 21. Humidity levels during the dehumidification process



Application Considerations:

- Increased cooling coil latent (dehumidification) capacity
- Lower achievable supply-air dew points.
- Decreased need for reheat

- Lower unit cooling sensible heat ratios.
- Warmer required chilled water temperatures.
- Improved energy efficiency for dehumidification.
- Decreased required cooling capacity when dehumidifying.
- Eliminates exhaust air as a requirement

For application guidelines concerning CDQ, see the *CDQ™ Desiccant Dehumidification Cool Dry Quiet Engineering Bulletin* (CLCH-PRB020-EN).

Dehumidification with Coil Runaround Loops

Series, coil run-around loops consist of finned-tube water coils connected in a closed loop that is “wrapped” around an active cooling coil. Operation is psychrometrically similar to the air-to-air, fixed-plate heat exchanger. The first coil in the loop pre-cools the incoming outdoor air. The active cooling coil absorbs more heat from the air stream and further dehumidifies the air to the design point. The second coil in the loop is placed after the active cooling coil and reheats the air with the heat absorbed by the first coil. Loop components include a pump to move the fluid within the loop and an expansion tank.

Series, coil runaround loops occupy little space and have a relatively low first cost. Like the series air-to-air, fixed-plate heat exchangers, series coil loops are only effective during the cooling season. Additional heating may be required on cool, humid or cold days.

Figure 22. Series dehumidification with coil run-around loops

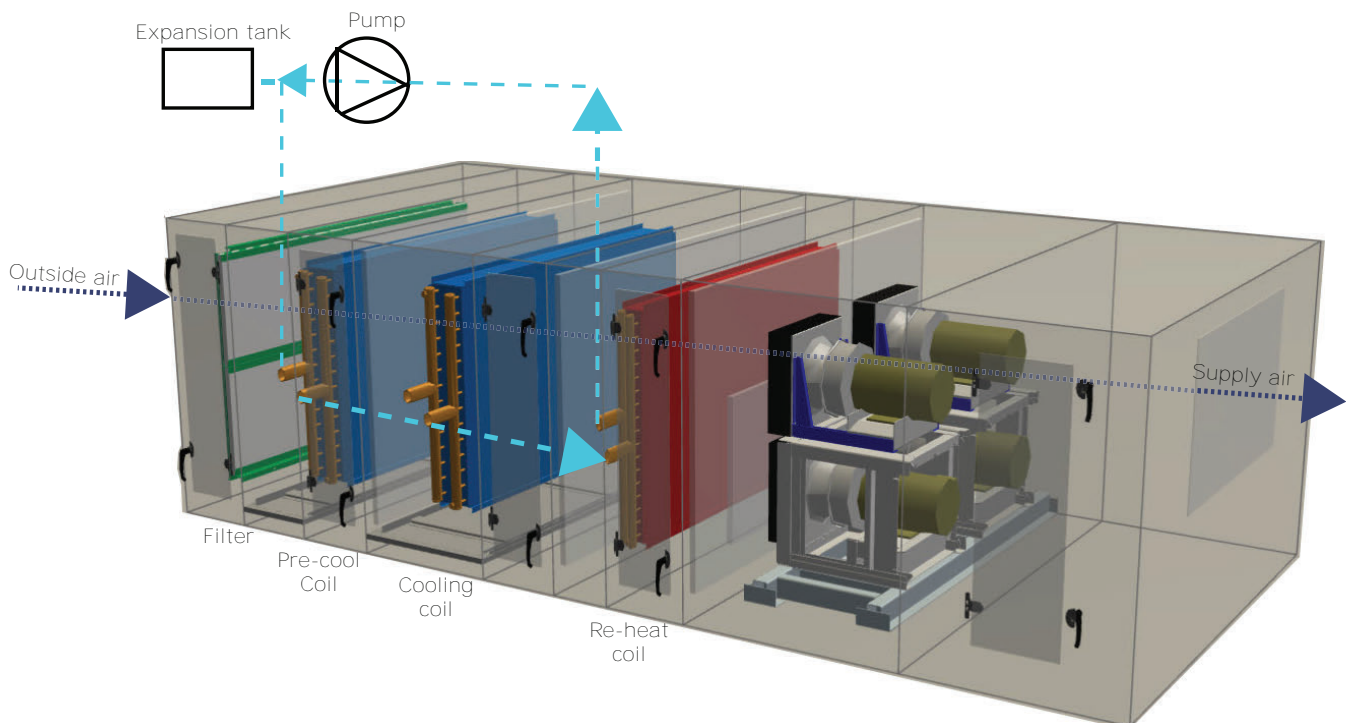

Application Considerations:

- Provide free reheat at design conditions
- Allow downsizing of new energy cooling and reheat coils
- Add a minimal pressure drop through each coil (only 0.3 to 0.6 in. wg)
- Are available in all Trane units
- Can be fully modulated by varying water flow

Dehumidification with a Split Dehumidification Unit (SDU)

The SDU is a dual-path, return-air-bypass air handler. It consists of two units that are stacked together in a draw-thru arrangement that share one supply fan. All of the ventilation (outdoor) air is ducted to the upper unit where it is dehumidified, typically down to 50°F or lower.

The lower unit is sized to handle the return air needed to achieve the desired air-change rate in the space. The warmer return air in the lower unit mixes with the cooler, drier air from the upper unit. The resulting mixed air provides humidity control by achieving a sensible heat ratio (SHR) of down to 0.4, but also provides sensible reheat without using any new energy.

A vertical unit stacks the supply fan on top of a vertical coil module; the outdoor air enters the back of the fan module. This unit is shorter than the horizontal SDU.

Outdoor air economizers can also be used with an SDU. Simply add a mixing module to the return-air unit and bring outdoor air into this mixing module when conditions permit economizing.

This configuration, sometimes called a “winterizer,” uses a combination of two different-sized air-handling units configured to allow the outdoor air to be introduced downstream of the cooling coil whenever the outdoor air is colder than 32°F (0°C). The smaller air-handling unit, sized for the minimum required ventilation airflow, contains filters and possibly a small preheat coil.

This “winterizer” configuration removes the length and pressure drop associated with a preheat coil from the main air path, resulting in a shorter air-handling unit than if a conventional preheat coil, air-mixing baffles, or an energy-recovery device is used. And, since it adds no static pressure drop to the design of the supply fan, it has less impact on fan energy than these other approaches. However, the cost of the second, smaller air-handling unit is typically higher than an air-mixing baffles, and it requires a second, smaller set of filters that need to be replaced periodically.

Figure 23. Horizontal indoor SDU

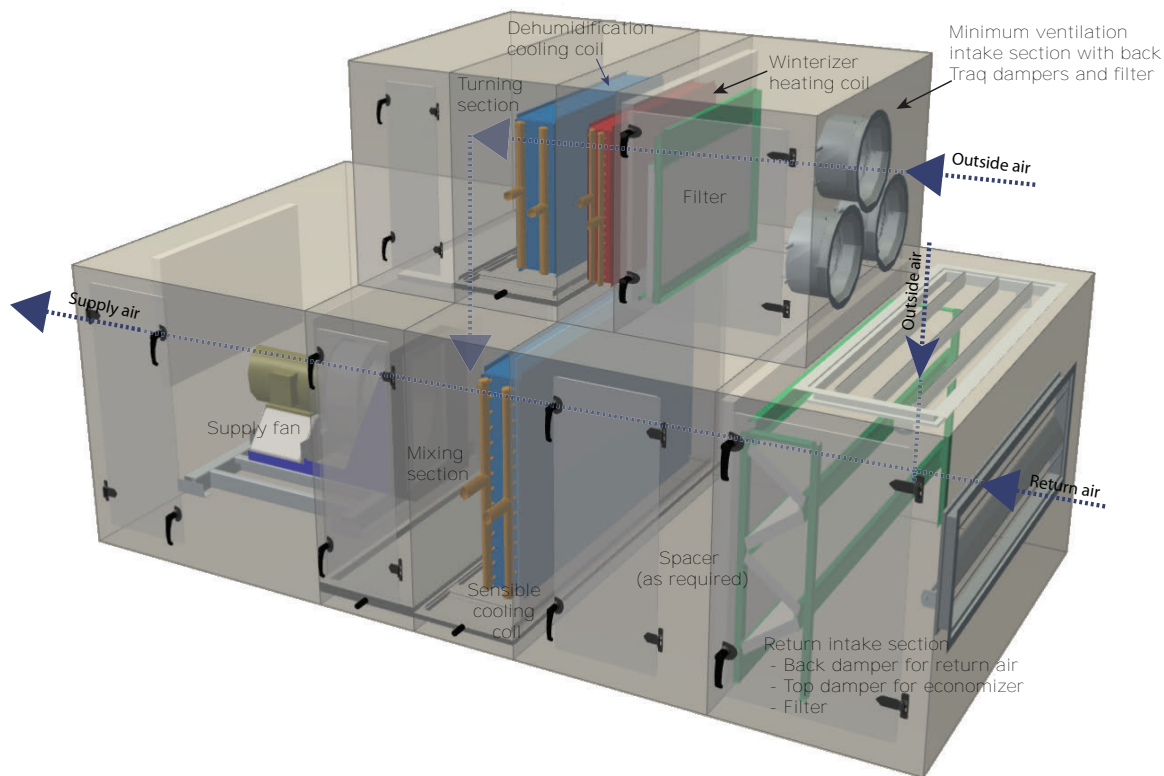

Application Considerations:

- Provides excellent humidity control in recirculating units, achieving SHR down to 0.4 without using new energy for reheat.
- Can offer significantly lower operating costs and a low first cost.
- Can be used in retrofits.
- Uses standard components.

- Does not require field-installed structural bracing.
- Has a small foot print.
- Available in sizes 3-50; upper unit sized between 20 to 50 percent of the lower unit.

Dehumidifying with outdoor units can also be achieved with an outdoor air pre-treating SDU or by using two units.

Figure 24. Dehumidifying with an outdoor air pre treating SDU (inlet hood shape varies)

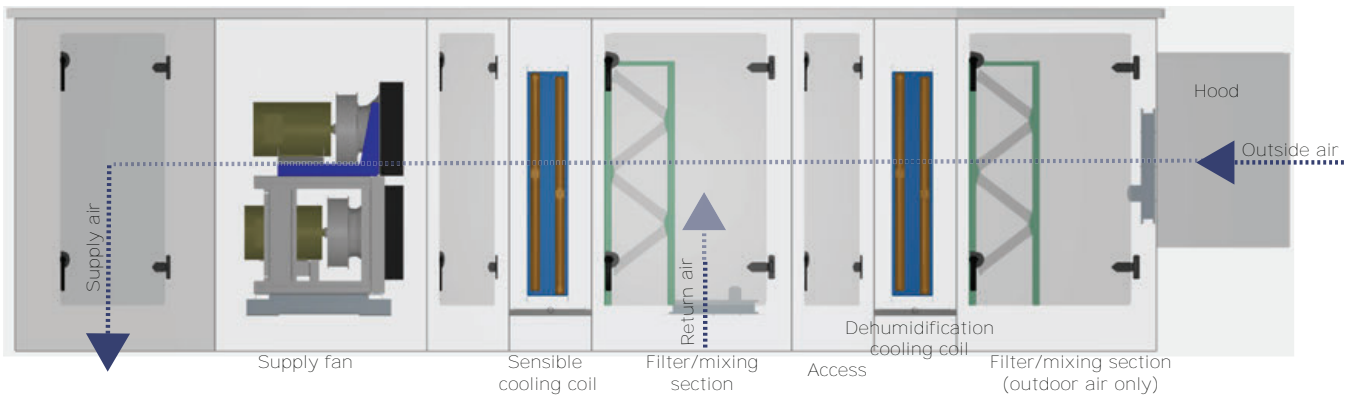
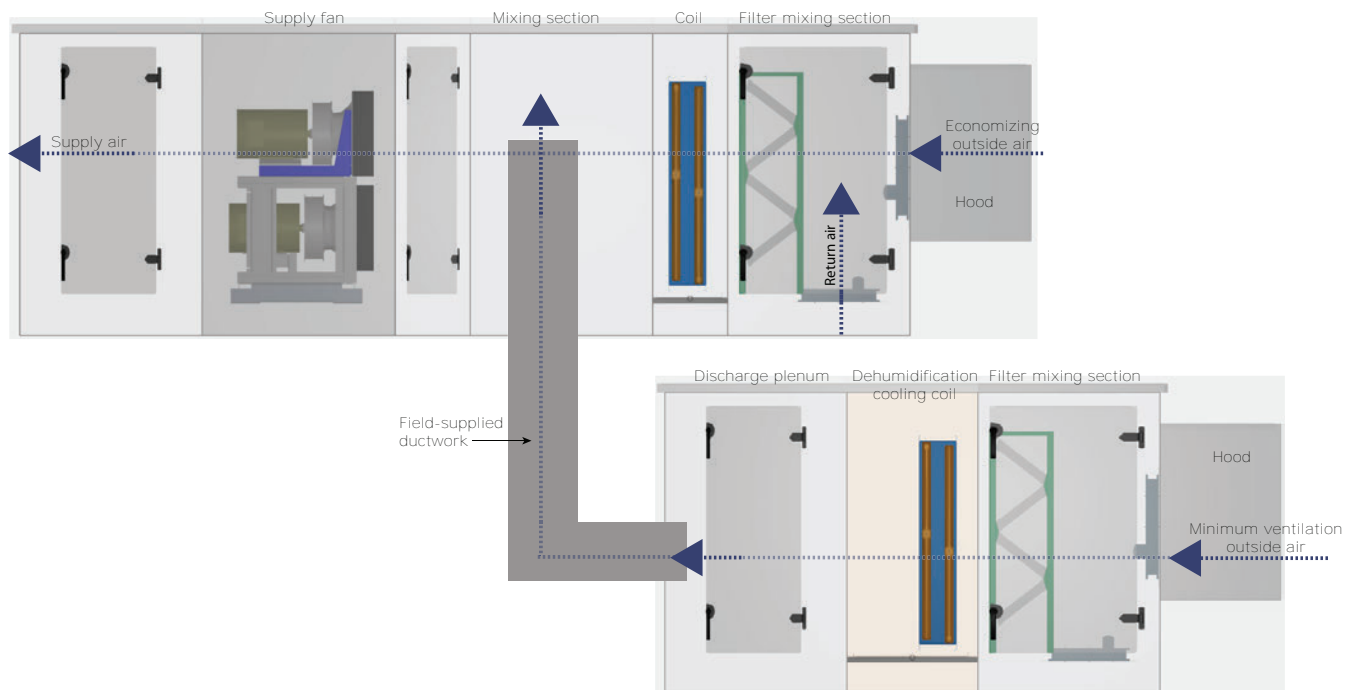

Figure 25. Dehumidifying with two outdoor SDUs (inlet hood shape varies)



Dehumidification with Hot Water Heat Recovery Coils

Using waste condenser heat from the chiller or compressor is a simple way to provide dehumidification reheat. With this dehumidification strategy, a hot-water coil is installed after the active cooling coil. Hot water from the chiller—or from an auxiliary condenser on the chiller—is piped to this coil. Free reheat is available any time the chiller is on.

Application Considerations:

- Work with recirculating or 100 percent makeup-air units.
- Provide excellent humidity control at any sensible heat ratio condition without using new energy reheat.
- Can reduce operating costs significantly.
- Can be used in retrofits.



Application Considerations

- Use standard Trane components.
- Provide proven, low-cost technology.

Energy Recovery

Trane air handlers offer high-performance solutions for airside energy recovery:

- Total energy recovery wheels
- Run-around coil loops
- Air-to-Air plate frame heat exchangers
- Trane's patented Sensible Assisted Membrane heat exchanger

These technologies transfer energy between the exhaust and outdoor air streams. Total energy recovery wheels transfer both sensible and latent energy between the air streams, while the coil loop transfers sensible energy.

Energy-recovery arrangements:

- Reduce operating costs.
- Can reduce first cost by allowing downsizing of chillers and boilers.

Energy-recovery systems can offer excellent energy savings when properly applied. Economic considerations must be carefully evaluated to determine the payback period of any energy-recovery system.

For more information, see the *Air-to-Air Energy Recovery in HVAC Systems Applications Engineering Manual (SYS-APM003-EN)*.

Energy Recovery with a Total Energy Wheel

This type of application is used to recover energy and moisture from the exhaust air stream. The wheel preheats and humidifies the supply air during the winter season and precools and dehumidifies the supply air during the summer season. The following graphics show an air handler arrangement with an exhaust fan, an economizer, and a total-energy wheel for indoor and outdoor units.

Figure 26. Energy-recovery with a total energy wheel in indoor unit

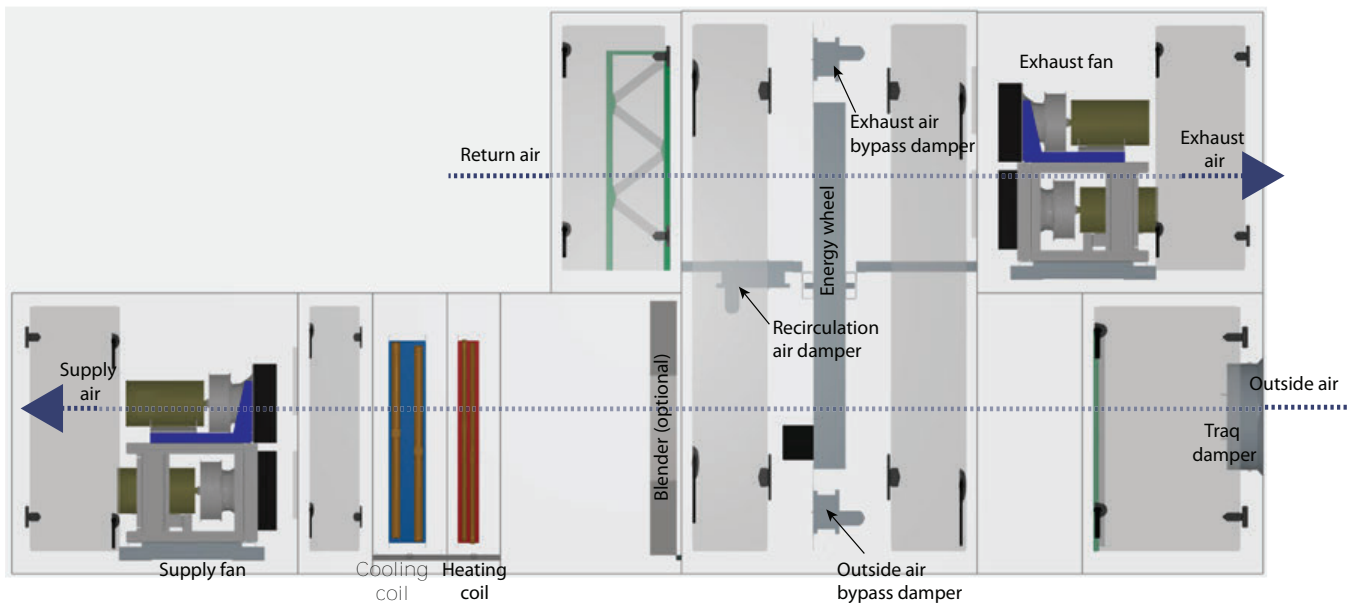
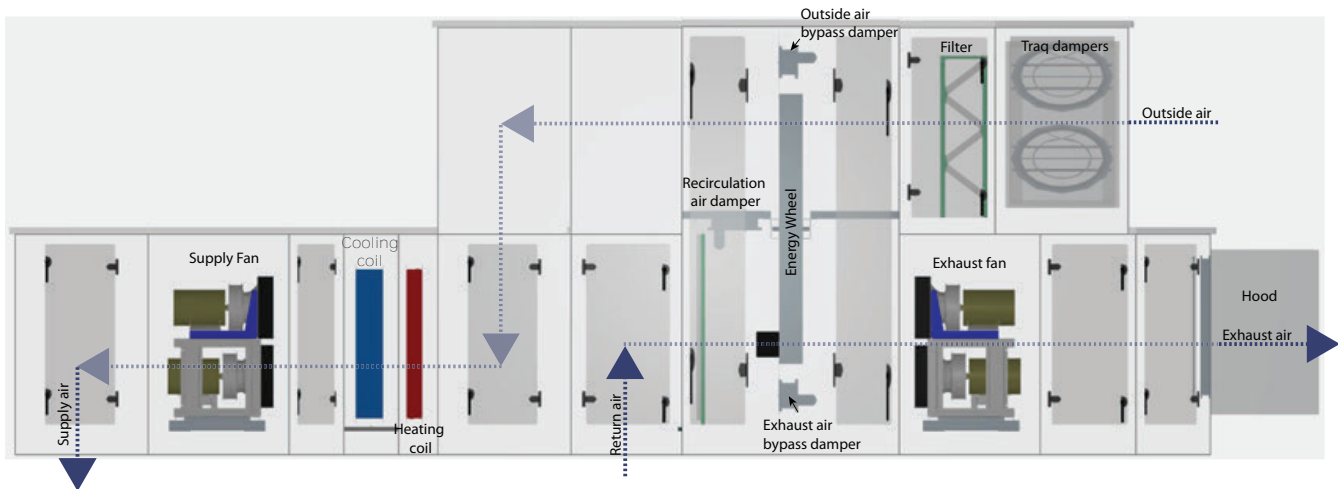

Figure 27. Energy-recovery with a total energy wheel in outdoor unit



As the return air enters the unit, a portion is recirculated through the recirculation air damper and the remainder goes through the wheel and is exhausted to maintain the required building pressure. Outdoor air enters an outdoor-air damper, then goes through the wheel and mixes with return air. During the economizing mode, the energy wheel is not used, and both wheel bypass dampers are open to allow up to 100-percent outdoor and exhaust airflow.

If the energy wheel module is used in a VAV system or in a unit that supplies cold supply air, modulating the exhaust-air bypass damper at the wheel can prevent the air from overheating during onset of the heating mode. If frosting conditions exist, modulating the outdoor-air bypass damper at the wheel can prevent vapor in the exhaust air from freezing on the wheel. If bypass frost control is used as freeze protection for the wheel, add a blender module to adequately mix the outdoor and exhaust air streams. If bypass frost control is not used, add outdoor-air preheat or return-air reheat.

Energy Recovery with Coil Runaround Loops

Outdoor-air and exhaust-air coil runaround loops recover energy that would normally be exhausted. They precool the outdoor air during the cooling season and preheat the outdoor air during the heating season. With coil loops, the outdoor and exhaust air streams do not need to be adjacent. This provides design flexibility for building renovations and new construction—at a first cost that is often lower than other methods of energy recovery.

Multiple exhaust and outdoor-air coils can be piped together with relative ease. Coil runaround loops use finned-tube hydronic coils in a closed loop to transfer energy. The heat-transfer fluid pumped within the loop is usually an inhibited solution of ethylene glycol and water to avoid freeze up.

Figure 28. Energy recovery with a runaround coil loop

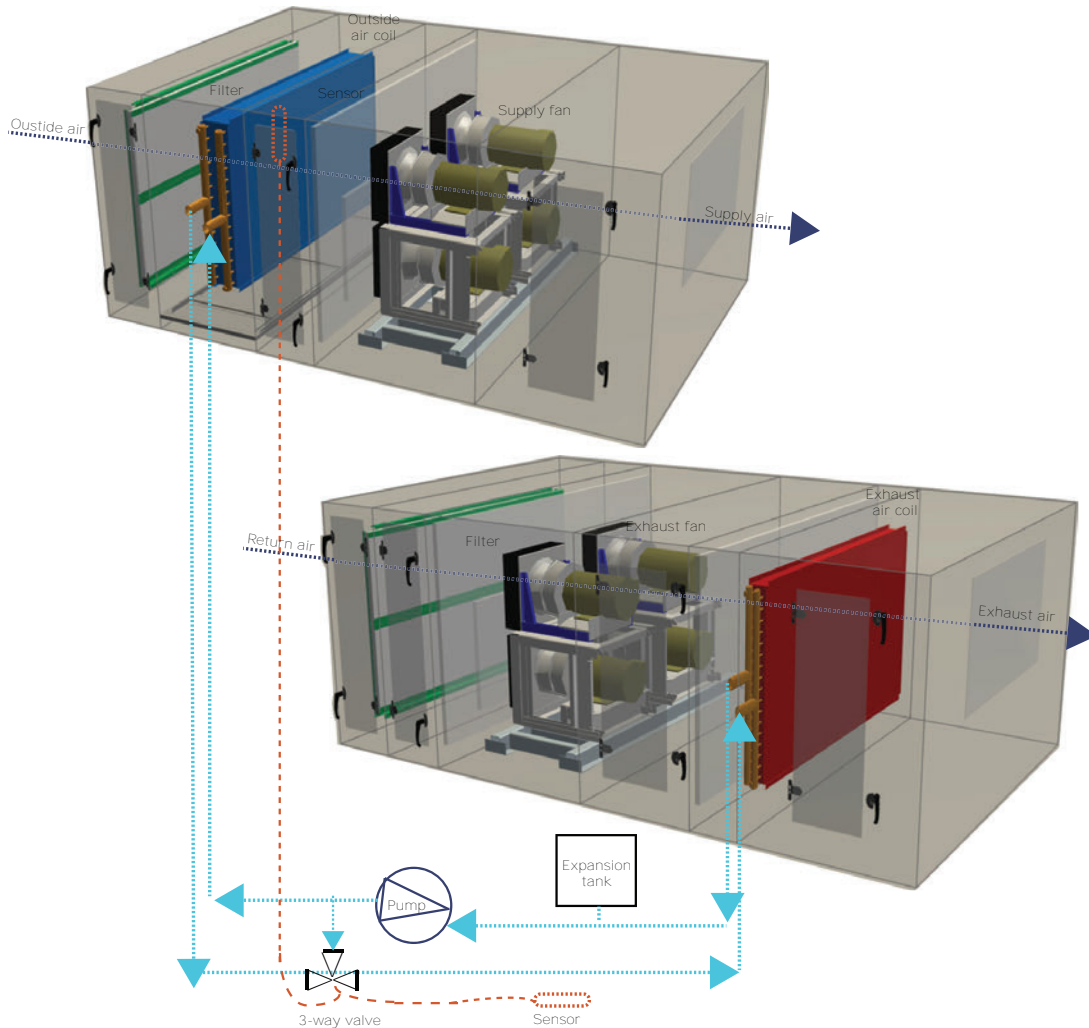

Coil loops offer complete separation of the air streams, thus eliminating any risk of cross-contamination. Loop components include the coils, a pump, expansion tank, and a three-way valve or variable-frequency drive (VFD). The expansion tank accommodates expansion and contraction of the internal fluid. The three-way valve or VFD modulates coil capacity. To prevent moisture in the exhaust air from freezing on the exhaust coil, the three-way valve can divert the warm fluid returning from the exhaust coil to the supply side of the coil.

Application considerations:

- Typical coil-loop effectiveness ranges from 45 to 65 percent with equal airflow and no condensation. Adhere to standard guidelines regarding coil construction, based on conditions. (See Trane catalog COIL-DS-1 and engineering bulletin COIL-EB-19 for more information.)
- Coil performance and airside pressure drops can be determined using Trane selection tools.

Energy Recovery with Air-to-Air Plate Frame Heat Exchangers

This type of application is used to recover energy from the exhaust air stream using cross-flow aluminum plates. The air-to-air (ATA) plate frame heat exchanger preheats the supply air during the winter season and precools the supply air during the summer season.

As the return air enters the unit, a portion is recirculated through the return-air damper in the mixing box and the remainder goes through the air-to-air plate frame heat exchanger and is exhausted to maintain the required building pressure. Outdoor air enters an outdoor-air damper, then goes through the ATA heat exchanger and mixes with return air. During the economizing mode, the ATA heat exchanger is not used, and bypass dampers are open to allow up to 100 percent outdoor and exhaust airflow. The center bypass dampers can be selected for either the outside air or exhaust air path, but not both.

If the ATA heat exchanger is used in a VAV system or in a unit that supplies cold supply air, modulating the exhaust-air bypass damper at the ATA heat exchanger can prevent the air from overheating during onset of the heating mode. If frosting conditions exist, frost avoidance dampers that block part of the outdoor air face of the exchangers close to minimize frosting potential. Frost control can also be achieved by modulating bypass dampers placed on the outside air side versus the exhaust side. If outside air bypass is used, freeze protection needs to be applied to any downstream hydronic coils.

Figure 29. Energy recovery with air-to-air (ATA) plate frame heat exchanger (Outside air hood shape varies)

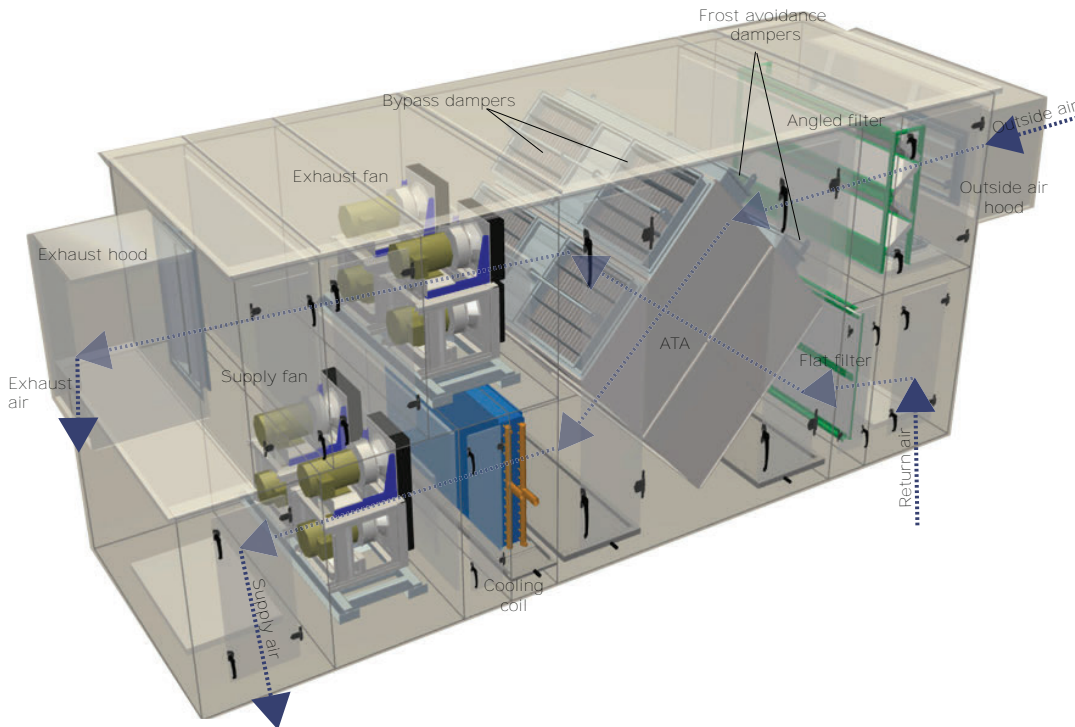

Variable Refrigerant Flow (VRF) Systems

Variable Refrigerant Flow (VRF) systems provided by Mitsubishi Electric Trane HVAC connected to Trane air-handling equipment provide flexible energy efficient designs while maintaining comfort utilizing the variable speed capabilities of VRF systems. Linear expansion valve (LEV) kits allow for coils to be connected to both heat recovery systems via a branch controller or heat pump outdoor units. Trane air handlers can be used as split systems providing solutions for dedicated outdoor air systems (DOAS), mixed air, or recirculating systems applied in variable air volume (VAV) and constant volume (CV) arrangements extending beyond the static pressure, system capacity, and product features commonly found in VRF installations.

Available Trane Pre-Packaged Solutions (PPS) easily connect Trane unit controllers and VRF system controls for full system integration with a Tracer building automated system (BAS).

Application considerations:

- Maximum refrigerant pressure
- Minimum refrigerant volume to ensure oil return
- Coil volume to LEV-kit requirements
- Allowable LEV-kit to coil distributor connected capacity and configuration
- Coil tube diameter and minimum tube wall thickness for heat pump or heat recovery applications
- Fan motor temperature limits for VRF zone temperature control

Acoustics

Designers are often challenged to select and arrange the air handler components so that the inlet, discharge and casing-radiated fan generated sound power levels help create a quiet space. To accomplish this, the designer must choose the right fan and determine whether additional unit attenuation is necessary.

Choosing the Right Fan

Obviously, the quieter the noise source (in this case, the fan), the less attenuation is needed along sound transmission paths. Selecting a quieter fan often increases the initial cost of the air handler, but can be a cost-effective system solution because it:

- Reduces the need for path attenuation (e.g., silencers) by diminishing the sound level along all transmission paths
- Reduces energy consumption (i.e., a fan is normally quietest when running at the most efficient point on its operating curve), providing operating cost savings to offset the initial cost.

Trane acoustical tests have shown that a fan's sound power (Lw) level depends on three factors:

- Type/design
- Operating point on the fan curve
- Application requirements (e.g., critical octave band frequency)

The following charts compare the inlet and outlet sound power levels of four different fans. Together, these charts demonstrate that fan inlet sound is not equivalent to fan outlet sound. More importantly, they underscore the need to obtain accurate, AHRI 260 tested sound data from the manufacturer so that appropriate source and/or path attenuation methods can be applied.

Trane gives designers a choice of many different fan types. See Components and Options, Fans section, for a summary of different fan application considerations and acoustical characteristics.

Figure 30. Comparison of discharge sound power by fan type

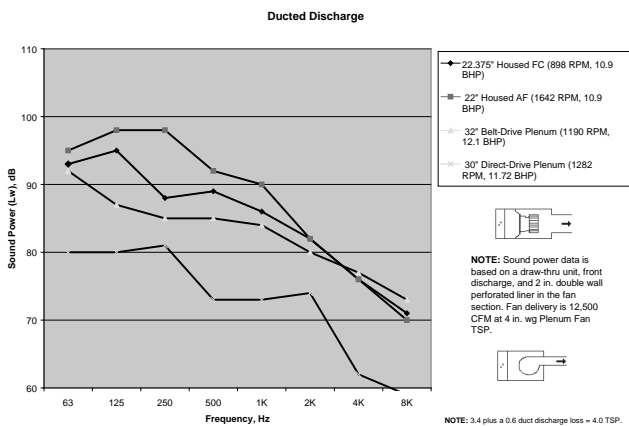
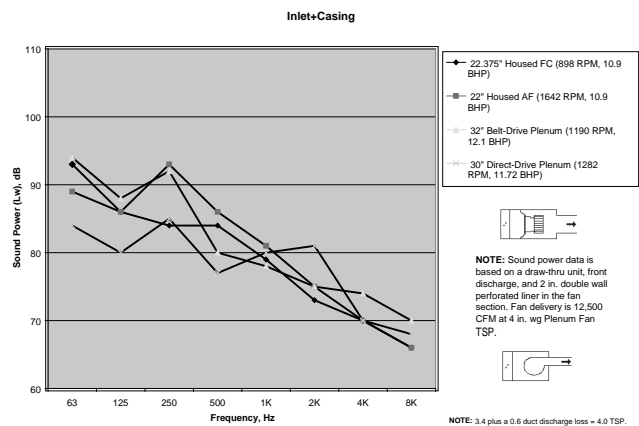

Figure 31. Comparison of inlet plus casing sound power by fan type



A2L Application Considerations

This product is listed to UL standard 60335-2-40, Household and Similar Electrical Appliances – Safety – Part 2-40: Particular Requirements for Electrical Heat Pumps, Air-Conditioners and Dehumidifiers, which defines safe design and use strategies for equipment using A2L refrigerants. This standard limits the refrigerant concentration in a space in the event of a refrigerant leak. To meet the requirements, the UL standard defines minimum room area, refrigerant charge limit, minimum circulation airflow and/or ventilation airflow requirements, and limits the use of ignition sources in spaces. The standard may require a unit refrigerant leak detection system.

For equipment with either:

- R-454B and charge amounts less than or equal to 3.91 lbs per circuit
- R-32 and charge amounts less than or equal to 4.04 lbs per circuit

this UL standard does not prescribe a room area limit and does not require a refrigerant leak detection system or any circulation airflow or ventilation airflow mitigation strategies. However, ignition sources in ductwork must be evaluated.

Depending on the application, a specific requirement of ANSI/ASHRAE Standard 15, Safety Standard for Refrigeration Systems, could be more stringent than UL 60335-2-40 requirements. See *Refrigeration Systems and Machinery Rooms Application Considerations for Compliance with ASHRAE® Standard 15-2022 Application Engineering Manual (APP-APM001*-EN)* for more information.

Leak Detection System (R-454B charge greater than 3.91 lb per circuit or R-32 charge greater than 4.04 lb per circuit)

The leak detection system consists of one or more refrigerant detection sensors. When the system detects a leak, the following mitigation actions will be initiated until refrigerant has not been detected for at least 5 minutes:

- Energize the supply fan(s) to deliver a required minimum amount of circulation airflow.
- Disable compressor operation.
- Provide an output signal that can be used to fully open zone dampers and/or VAV boxes and disable electric heat in VAV boxes.
- Provide an output signal that can be used to energize additional mechanical ventilation (if needed).
- Units without airflow proving will disable electric heat sources.

Building fire and smoke systems may override this function.

If the refrigerant sensor has a fault, is at the end of its life, or is disconnected, the unit will initiate the mitigation actions. Mitigation actions may be verified by disconnecting the sensor.

The refrigerant sensors do not need service. Use only manufacturer-approved sensors when replacement is required.

Notes:

1. *Factory-installed Symbio™ 500 controllers are programmed with leak detection sequence of operations at the factory.*
2. *Field-installed unit controllers require field programming of the UL leak detection sequence of operations by the controls contractor.*
3. *Factory-installed digital terminal blocks, which use a non-programmed Symbio 500 controller, require field programming of the leak detection sequence of operations by the controls contractor.*
4. *See UL 60335–2–40 for more information.*

Components and Options

Performance air handlers adopt a ‘building-block’ approach to air-handling design. Each ‘building block’ or section contains one or more components that serve a specific purpose unique to each application. The required function, layout, and arrangement of the air-handling system determines which sections must be included for a particular application.

Access/Blank/Turning Section

Access or blank sections can provide access to internal components for cleaning, maintenance, and service or to promote proper airflow through the unit.

A turning section is a blank section that alters the direction of airflow and reduces turbulence. It can also serve as an effective sound attenuator. When compared to a field-mounted, rectangular duct silencer, the turning section is less expensive to install, has a lower pressure drop, and provides more predictable performance. Perforated lining in the turning module attenuates mid-to high-frequency sound.

Note: Only large and extra-large blank sections can be selected as turning sections.

Blender

Blender sections contain air-mixing baffles, or blenders, that rotate the passing air streams, boosting their velocity for improved mixing. It is usually placed immediately downstream of a mixing box section, and should always be positioned upstream of filters and coils. The following chart documents blender performance at a downstream coil entering air temperature of 55°F and return-air temperatures of 70°F and 75°F.

Figure 32. Use blenders for coil protection

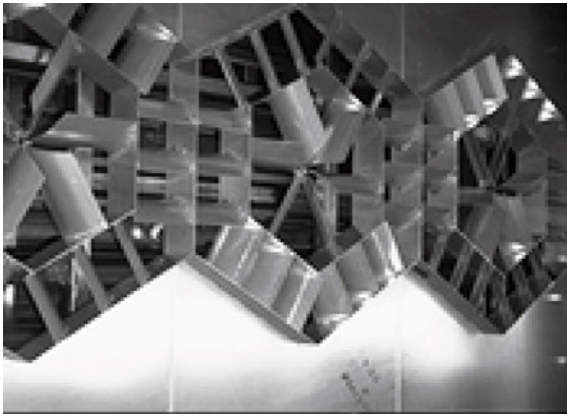
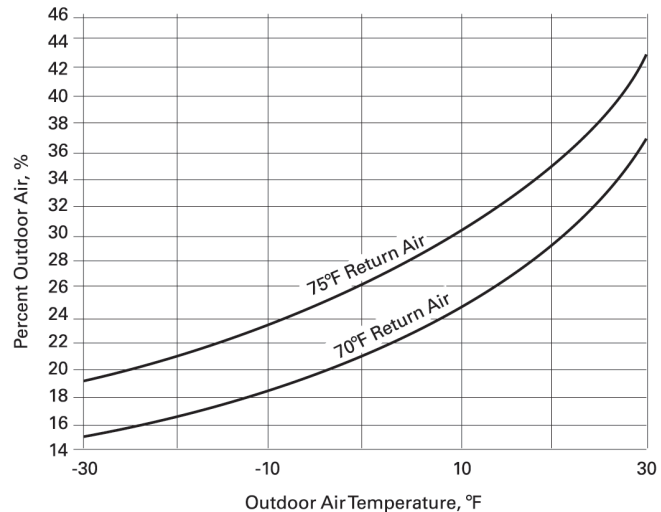

Figure 33. Blender performance with 55°F leaving air temperature



Application considerations:

- Blender face velocity should be in the range of 500 to 2000 fpm for proper mixing.
- When operated at temperatures within its design range, a blender may eliminate the need for preheat.
- Space is required both upstream and downstream of the blender to allow complete air mixing. The standard design of the blender section satisfies these spacial requirements.
- Select the mixing box such that the dampers are positioned at the top, back, or bottom when used with a blender.

CDQ™ Desiccant Dehumidification Wheel

The CDQ wheel section is a used to enhance the dehumidification performance of a traditional cooling coil. It utilizes a Type III desiccant (activated alumina) chosen specifically for air-handling applications. The wheel is configured in series with a cooling coil, and requires only one air stream. The CDQ wheel rotates between the entering and leaving sides of the cooling coil. CDQ wheels are sized based on supply fan airflow. Unlike conventional equipment, the dew point of the supply air is not equal to the

dew point of the air leaving the cooling coil. The required cooling coil capacity and air temperature leaving the coil are determined by the CDQ wheel performance.

For more application information, see the *CDQ™ Desiccant Dehumidification Cool Dry Quiet Engineering Bulletin* (CLCH-PRB020*-EN).

Figure 34. CDQ wheel



Application considerations:

- Available in 14 unit sizes, ranging from 1000 to 25,000 cfm
- Single wheel for unit sizes 3 to 50 with up to two wheels available per unit size
- Can be applied in mixed air and dedicated outdoor air systems
- Required cooling coil capacity is decreased when dehumidifying
- Entering water temperatures to the coil can be increased
- Section includes required space upstream and downstream of the wheel
- Required access and doors in section
- Variable effectiveness control using bypass dampers

Additional dehumidification options

- Dual-path split dehumidification units (SDUs)
- Low sensible-heat ratio coil selections
- Series recovery supply air tempering 100 percent outdoor air units in conjunction with other Trane airside products

Coils

3/8-inch, 1/2-inch, and 5/8-inch Coils

Figure 35. Coil with copper header

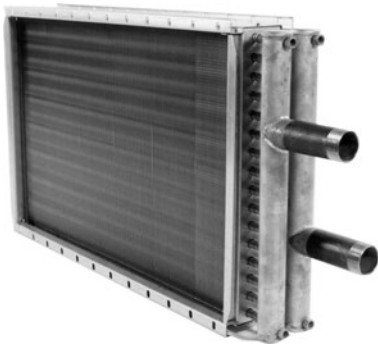
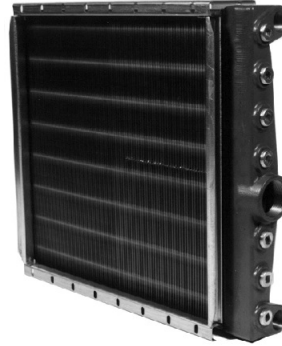

Figure 36. Coil with cast iron header



Trane offers 3/8-inch, 1/2-inch, and 5/8-inch coils in a variety of sizes, arrangements, and materials that allows the coil to be optimized for pressure drop and capacity requirements. Published coil performance is certified in accordance with AHRI Standard 410 and meets CRN (Canadian Registration Number) standards.

Trane is at the leading edge of coil technology. Through extensive laboratory testing and numerous job-site installations, Trane has developed unique fin surfaces for its coil offerings. These enhanced fin surfaces have superior heat transfer characteristics and allow greater velocities of air to move through the cooling coil without causing moisture carryover.

The industry is familiar with the 500-fpm limit through a cooling coil as a “rule of thumb” to safeguard against moisture carryover. However, some applications have tight dimensional constraints that require high coil face velocities. Trane fin designs extend this limit in excess of 625 fpm, depending upon air conditions, coil size, and coil-fin type, and spacing. Tested data for moisture carryover is incorporated in the Trane Select Assist. In cases where moisture carryover is possible, the Trane Select Assist program alerts you to this fact with a moisture carryover warning. See [“Face-Velocity Limits for Moisture Carryover,”](#) p. 88.

Coil options include but are not limited to the following:

- Two- to eight-row, 1/2-inch OD (outside diameter) chilled water or refrigerant coils
- Two- to 10-row, 5/8-inch OD chilled water or refrigerant coils
- One- or two-row 5/8-inch OD hot water coils
- One- to eight-row, 3/8-inch OD water coils
- Four, six, and eight-row, 3/8-inch refrigerant coils
- Two-row, 1/2-inch OD hot water coils
- One-row, 1-inch OD distributing-type steam coils
- Half, full, and dual-serpentine, circuited water coils
- Full face, split face, and intertwined circuited refrigerant coils

A variety of fin surfaces are also available, with the following options:

- Variable fin spacing on all fin types to fine-tune coil capacity and air-pressure drop
- Aluminum Delta-Flo™ H and Prima-Flo™ H fins that maximize the heat transfer and moisture carryover limits of the coils
- Aluminum Delta-Flo E and Prima-Flo E fins that minimize the coil air-pressure drop
- Aluminum Omega-Flo™ H fins
- Copper 5/8-inch Prima-Flo and 1-inch Sigma-Flo™ fins for corrosion protection

For additional information on coils, see *Air Heating and Cooling Coils For Comfort, Commercial, and Industrial Applications Quick Reference Guide* (COIL-PRC002*-EN).

Electric Heat

Figure 37. Typical draw through heater

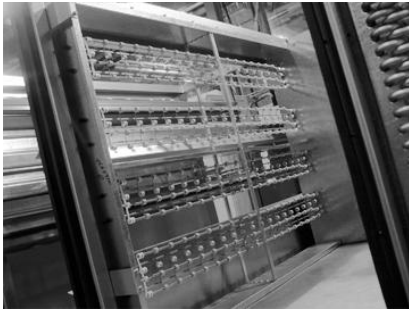

An electric heat coil is a relatively inexpensive first cost heating option compared to central plant boiler systems. Electric heat is a factory-installed, UL-listed option for unit sizes 3-66 draw-thru arrangements and 3-30 blow-thru arrangements in constant-volume or VAV applications.

Figure 38. Typical blow through heater



Integral Face-and-Bypass Coils

Conventional preheat systems are subject to coil freeze-up, stratification, and air-volume variation. An integral face-and-bypass (IFB) coil is specifically designed to minimize these problems, alternating heating and bypass channels with face-and-bypass dampers before and after the coil. If heat is needed, both dampers modulate open; otherwise, they remain closed to prevent “coil wiping” on the leaving side of the coil and to avoid unwanted heat pickup. This design effectively provides good freeze protection, constant airflow, and uniformly mixed and unstratified air. The IFB coil comes as a complete package (including heating coil, linkage, and dampers), thus assuring maximum system reliability. The section uses horizontal coil-tube arrangements in unit sizes 6 to 40 and vertical coil-tube arrangements in unit sizes 50 to 100.

These coils are capable of maintaining a constant heating discharge air temperature regardless of variations in entering air temperatures, with full steam pressure of hot water flow on the coils at all times. IFB coils consist of rectangular aluminum fin (0.010-inch thick) elements, with 5/8-inch O.D. 0.035 thick copper tubes completely enclosed in a 14-gauge galvanized steel casing, with 16-gauge dampers. Dampers are arranged to completely enclose and isolate the heating coil elements when no temperature rise is required. Holes in the unit casing for supply and return connections are factory provided to facilitate field piping of the coils. Factory-mounted electronic actuators are available when specified.

The following table list the sections required to house the integral face-and-bypass coil, and the downstream section required for proper air mixing space. External piping cabinets are required on both sections. An optional access door can be added to the downstream section on units with an integral face-and-bypass coil. On units with a vertical integral face-and-bypass coil, an access door must be included in the downstream section, on the opposite side of the coil connection, to facilitate field piping of the supply and return connections on the coil.

Table 4. Requirements for horizontal IFB coils

Unit size	3	6	8	10	12	14	17	21	25
IFB section size	n/a	Large	Large	Large	Large	Large	Large	Large	Large
Down-stream section size	n/a	Med	Med	Med	Med	Med	Med	Med	Med
Unit size	30	35	40	50	57	66	80	100	
IFB section size	Large	Med-Large	Med-Large	Med-Large	Med-Large	Med-Large	Med-Large	Med-Large	
Down-stream section size	Med	Med	Med	Med	Med	Med	Med	Med	

External piping cabinets are required on both the IFB coil and the section immediately downstream of the coil. An optional access door can be added to the downstream section. On units with vertical IFB coils, an access door must be included in the downstream section to facilitate field piping of the supply and return connections on the coil.

It is recommended that a factory selection of a coil be made based on scheduled performance prior to configuring a unit with an IFB coil, so as to determine whether the unit should be configured around an integral face-and-bypass coil or a vertical integral face-and-bypass coils.

Drain Pans

- Galvanized or stainless steel drain pans sloped in two directions to assure positive drainage helps prevent corrosion.
- Drain pans that can extend beyond the cooling coil for periodic cleaning are standard options.
- A variety of cooling coil fin options, including the high-efficiency H-fin design, are available. These fins allow for coil selections with face velocities in excess of 625 fpm without moisture carryover.
- UV-C lights help preventing mold, bacteria and viruses from reproducing and also maintains or improve the system efficiency. Factory engineering and UV-C lights installation allows us to maximize the benefits of UV technology without jeopardizing the expected reliability and safety of the equipment.

Dampers

Face-and-Bypass Dampers

Designed to divert airflow around a coil, the face-and-bypass damper can be used to control humidity or provide freeze protection for hydronic coils. Face-and-bypass dampers are available in two module configurations, internal and external.

Internal Face-and-Bypass Dampers

Figure 39. Internal dampers



Typically used immediately upstream of a modified-size (less than 100 percent airflow) coil, this arrangement enables temperature control while operating the preheat coil at full flow. The dampers modulate to bypass air around the heating coil when the outdoor air temperature is warm enough to preclude freezing.

Figure 40. Damper arrangement

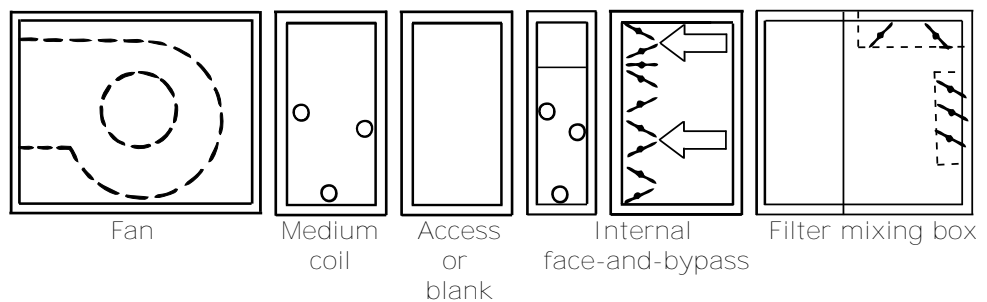

Application considerations:

- To ensure full airflow coverage across downstream coil banks, provide extra distance after the modified-size coil section.
- Consider the effect of reduced bypass area, higher velocities, and higher pressure drops when designing internal face-and-bypass configurations that require 100-percent bypass. External face-and-bypass dampers may be better suited for these configurations.

Table 5. Recommended distance between coils to ensure full airflow coverage

Unit size	Distance between coils (inches)
3, 6	12.00
8, 10	18.00
12, 14	24.00
17	30.00
21	33.00
25-40	36.00
50	48.00
57, 66	57.00
80	69.00
100, 120	78.00

Traq Dampers and Low-Flow Traq Dampers

Figure 41. Traq dampers

The Trane AMCA 611-certified Traq™ airflow-monitoring solution allows direct measurement and control of outdoor and/or return airflow and is rated for a maximum leakage rate of 3 cfm/ft² at 1-inch w.g. complying with ASHRAE Standard 90.1 maximum damper leakage. The Traq option can be used as a key part of a demand control ventilation strategy to help drive down energy costs. When applied as part of the Tracer SC system controls building management system, ventilation airflow can be controlled dynamically and documented to verify compliance with ASHRAE Standard 62.1. (See *Building Automation System Tracer Summit* (BAS-PRC001*-EN) Factory-mounted and tested to reduce installation and startup costs, the Traq damper also requires significantly less straight duct than traditional airflow-monitoring stations and does not require upstream straightening vanes for proper operation that could become clogged with debris.

The bell-mouth inlet of each damper guides air uniformly through a flow-sensing ring that accurately measures total and static pressure from 100 percent of nominal airflow down to 300 fpm through the damper. The damper assembly's ventilation control module (VCM) produces a 2-to-10-Vdc signal that is proportional to airflow, recalibrates itself once every 60 seconds, and automatically adjusts for temperature variations. Depending on unit size and controls configurations Traq dampers can measure from 100 percent of design CFM, down to five percent design CFM.

Application considerations:

- The Traq damper mixing box requires only one duct diameter of straight inlet duct (as much as 80 percent less than other airflow monitoring techniques).
- Connecting a Traq damper equipped air handler to a building automation system, such as a Tracer building management system, permits:
 - Dynamic calculation of the outdoor air needed to adequately ventilate a multispace VAV system and reset the outdoor-air setpoint accordingly to save energy.
 - Trend logs and custom reports to document compliance with ASHRAE Standard 62.1.

Diffuser

A diffuser consists of pressure-equalizing baffles that are designed to provide even airflow across components downstream of a fan. The diffuser section is typically used immediately downstream of a centrifugal fan in a blow-thru filter, coil application.

Discharge Plenum

Figure 42. Discharge plenum



Before leaving the air handler, supply air can be ducted to a discharge plenum section. The rapid air-stream expansion as it passes into the plenum reduces turbulence and creates an acoustical end reflection that dampens low-frequency sound. Perforated panels can be selected as an additional attenuation option. Two configurations enable supply-duct connections from any side:

- *Vertical-mounted* plenum sections mount atop an adjacent section and can be increased 1.5 times or reduced 0.5 times to standard height minimizing field duct transitions. Openings can be factory- or field-cut.
- *Horizontal-mounted* plenum sections mount on the front of an adjacent section. Openings can be factory- or field-cut.

Vertical and horizontal discharge plenum openings can be tailored to the size, type and location to best fit the velocity and static pressure requirements, improving energy efficiency and sound. Round, rectangular, and bell mouth openings are all available.

Energy Recovery

Increased ventilation airflow requires more energy to heat or cool and can significantly affect operating costs. Bringing in more fresh air when it is cold outside also increases the risk of coil freeze-up. Trane airside energy-recovery solutions address both energy consumption and coil protection by recovering heat from the exhaust air stream to pre-condition outdoor air entering the building. Trane has many factory-packaged energy-recovery solutions including:

- Total energy recovery wheels to recover both sensible and latent energy.
- Coil-runaround loops to recover sensible energy.
- Air-to-air plate frame heat exchangers recover sensible energy.
- Sensible assisted membrane.

Energy Wheels

Figure 43. Energy wheel



The energy wheel section is a total-energy-recovery device; it recovers both sensible and latent energy. It consists of a rotating wheel that contains heat exchange media surfaces. A desiccant material specifically designed for adsorption and desorption of water vapor is permanently bonded into the heat exchanger matrix. The wheel rotates between the outdoor- and return-air paths, whose air streams are counter-flow.

Energy wheels are sized based on the ventilation air requirement and can be applied in a 100 percent outdoor air unit or a recirculation unit. Internal wheel-bypass dampers vary the effectiveness of the wheel.

For more application information on energy recovery, see the *Air-to-Air Energy Recovery in HVAC Systems Applications Engineering Manual* (SYS-APM003*-EN).

Application considerations:

- Certified in accordance to AHRI Standard 1060
- Available in 18 sizes, depending on ventilation requirements ranging from 900 to 25,000 cfm
- Single wheels for sizes 3-50 with up to seven wheels available per unit size
- Greater than 70 percent total effectiveness at a pressure drop of 1-in. to 1.15-in. w.g. and nominal airflow through the wheel
- Bypass dampers are standard for partial-flow energy wheel sections
- Standard, built-in return damper for partial-flow, recirculating wheels for sizes 6-50
- Section includes required space upstream and downstream of the wheel
- Required access and doors in the section
- Variable effectiveness control using air bypass
- Frost protection using an air bypass damper or a separate pre-heat module

Coil Runaround Loop

Figure 44. Coil runaround loop



A runaround loop, used to recover sensible energy, consists of two finned-tube coils (air-to-water heat exchangers) piped together; one coil resides in the outdoor airstream and the other in the exhaust airstream. An expansion tank, pump, three-way temperature control valve and working fluid (usually an inhibited solution of ethylene glycol and water) complete the recovery system.

Since the outdoor and exhaust airstreams need not be adjacent, the runaround loop provides design versatility well-suited to building renovations – at a lower first cost than other methods of energy recovery. Complete separation of the airstreams also eliminates the risk of cross-contamination.

Application Considerations:

- Recovery is limited to sensible energy with effectiveness that typically ranges from 60 to 65 percent.
- Together, the two finned-tube coils may contribute approximately 0.3 to 0.6-in. w.g. to system static pressure.

Air-to-Air Plate Frame Heat Exchanger

Figure 45. Air-top-air plate frame heat exchanger



Air-to-air plate frame heat exchangers is a sensible-energy-recovery device. The exchanger consists of aluminum plates that are stamped into a dimpled or channeled shape. The plates are stacked on each other with the alternate edges crimped and sealed to prevent cross leakage.

These can handle high pressure differentials, some up to 10-inches between the exhaust and outdoor air side. They also can handle higher temperatures and can be coated for corrosion protection.

Application Considerations:

- Certified in accordance to AHRI Standard 1060.
- Three plate spacings available.
- Bypass options available for variable effectiveness and frost prevention.
- Up to 70 percent total effectiveness with close spacing.
- Drain pans always required.
- Can be used in a series arrangement for dehumidification.
- Anti-corrosion coating available for corrosive environment application.

Fans

An extensive array of fan types and options, including variable-frequency drives (VFDs) for modulation in variable-air-volume systems, lets you optimize the fan to best fit not only the airflow and static pressure requirements, but also the acoustical, efficiency, and discharge requirements.



Components and Options

Fan types include:

Single-width/single-inlet (SWSI) plenum fans with multiple or single discharges on the front, top, bottom, or sides of the section

- Direct-drive plenum fans
- Motorized impellers

Plenum fan openings can be tailored to the size, type and location to best fit your velocity and static pressure requirements improving energy and sound. Round, rectangular, and bell mouth openings are all available.

Each fan is rated in accordance with Standard 430 of the Air Conditioning Heating and Refrigeration Institute (AHRI) and all DWDI fans are AHRI Standard 430-certified to assure published performance.

The following table summarizes and compares the characteristics and application considerations of these fans. When evaluating the merits of each fan type for a given application, consider the volumetric rate of airflow, static pressure, required sound characteristics, and space.

Table 6. Fan summary information

Type	Direct-Drive Plenum fan	Motorized Impeller (MI) Plenum Fan
Fan type	Unhoused	Unhoused
Inlet	Single	Single
Airflow direction	Pressurized, all directions	Pressurized, all directions
Optimal pressure range	Medium- high (2-8-in. wg)	Medium- high (2-8-in. wg)
Range of maximum speed	1780-5750	1380-3100
Blade shape	Airfoil	Backward curved
Suggested source attenuation	Include fiberglass lining in the fan section, add fiberglass-lined discharge plenum or outlet/inlet silencer.	Include fiberglass lining in the fan section, add fiberglass-lined discharge plenum or outlet/inlet silencer.
Direct upstream space required in draw-thru arrangements	Medium module	Medium module
When to use	Multiple-duct arrangement, blow-thru applications	Multiple-duct arrangement, blow-thru applications
K_t loss, abrupt discharge ^(a)	—	—

^(a) In draw-thru applications, fan curves assume three diameters of straight duct downstream of the fan. See the AMCA 201-02, Fans and Systems, for more information when this assumption is not valid.

To verify that fan performance will satisfy design requirements, use the Trane Select Assist selection program. The AHRI Standard 430-certified fan curves include the fan section casing effect. Trane Select Assist also takes into account ductwork connections, air density, fan and motor heat, drive losses, and use of high-performance (MERV 11 and higher) filters affect fan performance.

Constant Volume vs. VAV Systems

Depending on the fan-control method used, the fan can provide either a constant or variable volume of supply air. In a constant-volume system, the fan delivers a consistent amount of air and cooling and heating devices adjust the air temperature for occupant comfort. Because the fan runs at constant horsepower under all load conditions, system operating costs are higher than those of a VAV system.

A VAV system provides occupant comfort by delivering a modulated amount of constant-temperature air. Usually, supply-duct static pressure determines how much air the fan provides. Varying fan horsepower with building load can offer substantial energy savings and do a better job of controlling space humidity.

Fan modulation is accomplished with a variable-frequency drive (VFD) that adjusts fan speed and airflow by varying motor speed. VFD modulation is quiet and energy efficient; it can also prolong the life of the fan motor by “soft starting” it.

Airflow Measuring Systems

Figure 46. Airflow measuring system



A fan inlet airflow measuring system with a piezometer ring is also available on many centrifugal and plenum fans. Each system comes with a differential pressure transmitter. The piezometer ring is connected to the LO port of the transmitter and the reference pressure point is connected to the HI port of the transmitter.

Filtration and Air Cleaning

Effectively controlling particulate and gaseous contaminants by reducing their concentrations or removing them from the air stream altogether is key to good IAQ. That necessitates proper filter selection. Filtration and cleaning options include:

- Pleated media (MERV 8 to 15 based on ASHRAE Standard 52.2)
- Bag or cartridge filters (MERV 11 to 15 based on ASHRAE Standard 52.2)
- HEPA filters (MERV 17 based on ASHRAE Standard 52.2)
- Trane Commercial Air Purification System (TCAPS) reduce VOCs to a non-harmful state
- Antimicrobial treatments for filters inhibiting microbial growth (MERV 7 based on ASHRAE Standard 52.2)

Filtration Options

Bag filter-entering side



Bag filter — leaving side



HEPA filter section



Air handlers can be equipped with a variety of filtration options, all tested in accordance with ASHRAE Standard 52.2. The continuous operating range of both the high-efficiency filters and the disposable prefilter is typically 0°F to 150°F, but can be as high as 200°F. Available filters and minimum efficiency reporting values (MERV) are:

- Two-inch permanent-MERV 2
- Two-inch disposable-MERV 5
- Two-inch and four-inch pleated media-MERV 8-15
- Eighteen-inch and 30-inch bag or 12-inch cartridge filters-MERV 11-15
- Two-inch and four-inch antimicrobial-treated filters-MERV 7
- HEPA
- Multiple side-loading and front-loading filter options

Application Considerations:

- Higher filter efficiencies cost more, but provide cleaner air and better system performance. National, state, and local codes may also specify filter performance.

Components and Options

- Operating resistance to airflow (i.e. pressure drops). Filter resistance and first cost may increase with efficiency.
- High filtration efficiencies sometimes require more space, which lowers velocity, and may enlarge the air handler footprint.
- A high degree of filtration can lower cleaning costs in the occupied space.
- Exceeding the face velocity limit of the filter increases its resistance (as well as fan energy consumption) and necessitates more frequent maintenance or replacement.
- Exercise special care to avoid moisture carryover whenever final filters are used. Never place a blow-thru final filter section directly downstream of a cooling coil without providing an intervening source of reheat (such as fan motor). Tests have shown that certain entering-coil conditions can create water vapor that *will* collect on the final filter. The only known solution for this intermittent application issue is two degrees of reheat.
- Treating filter media with an antimicrobial coating can reduce the likelihood of microbial contamination. Trane coated pleated media filters can be treated with an antimicrobial coating.
- Install bag filters with the pleats vertical to the floor of the unit.
- Provide easy access to encourage regular filter maintenance.
- High-efficiency filters and disposable pre-filters may be operated near 100 percent relative humidity; however, they may not come in direct contact with water droplets.
- Keep filters dry.

Trane Commercial Air Purification System

Figure 47. Trane commercial air purification system

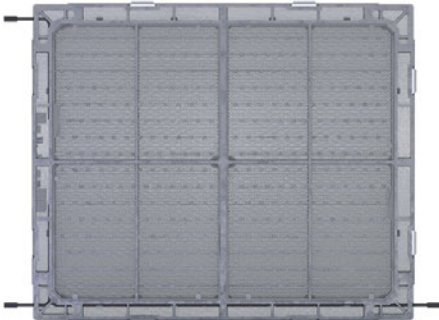

The Trane Commercial Air Purification System (TCAPS) is a factory engineered and installed combination of two air cleaning technologies: MERV 8 or MERV 13 particle collection, and graphene enhanced photo-catalytic oxidation (GPCO). The high efficiency MERV 8 or MERV 13 filters are very effective at removing small, respirable particles from the airstream. The GPCO combination reduces volatile organic compounds (VOCs) through photo-catalytic oxidation without the creation of ozone or by-products.

The UV energy in the TCAPS creates hydroxyl radicals on the surface of the titanium dioxide which oxidizes VOC contaminants that they contact. All reactions occur within the air cleaner and no by-products leave the unit. The factory installed system comes complete with appropriate safety mechanisms protecting the owners and operators of the system. These safeties include an external disconnect with lock-out/tag-out capabilities, door interlock switches, and viewport.

Gas Heat

Figure 48. Gas heat



Gas heat can be an economical source of heat when compared to traditional heat sources such as central plant boilers with hot water or steam coils installed inside air handlers, or electric resistance heating installed inside air handlers.

Gas heat can be a good heating option for any of the following applications:

- Climates and applications with large heat loads
- Applications with high outside air requirements to comply with ASHRAE Standard 62
- Buildings without a central boiler plant
- Remote locations where boiler capacity or water piping expense is prohibitive
- Areas with relatively inexpensive natural gas or expensive electricity

Application considerations:

- Gas heater must be applied in a blow-thru configuration to insure that combustion gases will not enter the airstream due to the positive static pressure.
- Maximum temperature rise is 101° F.
- When reducing airflow, the control system should not allow the temperature rise through the gas heat section to exceed the nominal at full airflow.

- On high altitude applications, derate the heating capacity (MBh) by 4 percent for every 1,000 feet over 2,000 feet.

Humidifier

Figure 49. Humidifier



ASHRAE Standard 62.1 suggests maintaining a relative humidity of no less than 30 percent to provide a comfortable, healthy indoor environment. The humidifier uses low-pressure steam distributors to add moisture to the air. This can be accomplished by using either building steam or an atmospheric steam generator. It includes accessories such as valves, strainers, and traps. Factory mounting within the air handler lowers the installed cost of the humidifier and keeps moisture out of the supply duct.

Application considerations:

- Airflow through the humidifier must be horizontal and of relatively uniform velocity (400 to 700 fpm).
- Do not locate the humidifier upstream of filters, gas heat, electric heat, or active cooling coils.
- Blow-thru applications with housed fans require at least a four-row coil between the fan and humidifier modules. The diffuser alone is unacceptable.
- To prevent condensate formation, the relative humidity leaving the humidifier should not exceed 83 percent. Contact your local Trane sales engineer for application-specific guidance.
- The required dispersion distance is designed into the humidifier section.
- Vertical airflow turning immediately upstream and downstream of the humidifier section requires a large turning section.

Inlet Hood

Figure 50. Standard hood

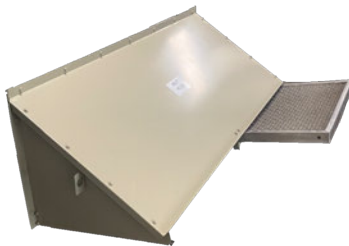

Inlet hoods include a moisture eliminator. See the tables in Performance Data chapter for maximum allowable inlet hood airflow limits.

Many specifications require that there be a minimum distance between the point that outside air enters an air handler and the roof of a building. This distance is to minimize the possible introduction of contaminants into the conditioned air. ASHRAE 62 recommends that there be at least 9-inches (or 8-inches above maximum snow depth) separation from the roof to the outside air intake, however, some specifications, specifically for units in the health care industry require at least 36-inches of separation distance. When configuring an air handler, ensure that the unit in conjunction with a roof curb will meet the specifications requirements on separation distance.

Figure 51. Hurricane hood



Mixing Box

Figure 52. Mixing box



A mixing box section typically combines the incoming outdoor air with recirculated return air collected from the occupied space. It is commonly included in an air handler design to control this mixture. When equipped with an optional Traq damper, the mixing box module permits direct measurement of outdoor airflow to assure compliance with ASHRAE Standard 62.1.

Application considerations:

- The Traq damper mixing box requires only one duct diameter of straight inlet duct (as much as 80 percent less than other airflow monitoring techniques).
- Connecting a Traq damper equipped air handler to a building automation system, such as a Tracer building management system, permits:
 - Dynamic calculation of the outdoor air needed to adequately ventilate a multispace VAV system and reset the outdoor-air setpoint accordingly to save energy.
 - Trend logs and custom reports to document compliance with ASHRAE Standard 62.1.
- For indoor units, an additional mixing box can be used as an economizer to provide an exhaust path for return air, allowing the main mixing box to provide natural, non-mechanical cooling when outdoor air conditions are suitable.
- Use freeze protection for coils downstream of the mixing box when incoming outdoor air is below 35°F (see [“Protect Coils from Freezing,”](#) p. 16 section in HVAC Designs Fundamentals chapter”).
 - The economizer meets or exceeds all mandatory requirements prescribed by Title 24, including but not limited to:
 - 5-year parts only warranty
 - Successfully tested to 60,000 actuations
 - Less than 10 cfm/sq.ft. of damper leakage at one inch w.g. per AMCA 500L

Silencers

Figure 53. Silencers



Controlling noise at its source is the most cost-effective solution for providing quiet comfort in the space. Source attenuation can eliminate the need for duct-mounted silencers and thereby lower fan operating costs. The key to a quiet design is to know which options and layouts have a sound source that achieves the target noise criterion (NC) level when reduced by space attenuation. It all starts with accurate, tested sound data, and Trane has the most complete sound power data in the industry.

The design process involves predicting the unit sound power and projecting it into the space, then optimizing the path attenuation (ductwork, ceilings) and the unit sound (fans, plenums) to get the lowest cost system that meets the requirements. Designing the right unit is a matter of experience and solid acoustical data. Obviously, the quieter the sound source, the less path attenuation is needed in the sound paths. Minimizing the sound source, using a quieter fan, or using more source attenuation increases the initial cost of the air handler, but is generally offset by significant path-reduction cost savings.



General Data

This section includes summary information of heaviest weight per unit size, including section dimensions and weights, coil availability, filter areas and sizes, fan section weights and application data, and damper areas.

Note: For specific dimensional and weight information, see the unit submittals. The dimensions and weights in this manual are approximate. Trane has a policy of continuous product and product data improvement and reserves the right to change design and specifications without notice.

Table 7. Dimensions — unit sizes 3 to 30

Unit size	3	4	6	8	10	12	14	17	21	25	30
Nominal airflow ^(a)	1500	2000	3000	4000	5000	6000	7000	8500	10,500	12,500	15,000
Airflow at 625 fpm ^(b)	2169	3475	4338	4581	6075	8331	9025	11,806	13,456	16,944	19,025
Height - indoor unit ^(c)	29.00	29.00	35.25	37.75	37.75	41.50	41.50	49.00	52.75	61.50	61.50
Width	31.50	44.00	44.00	50.50	61.50	66.50	72.00	72.00	80.00	80.00	93.50
Height for outdoor unit includes base drip lip ^(d)	36.25	36.38	42.63	45.13	45.13	49.25	49.25	56.75	60.5	69.25	69.25

- (a) Nominal airflow is based on 500 fpm through a nominal coil (i.e. 500xunit size 8=4000 cfm).
- (b) Airflow@625 fpm through the flat filter (maximum filter velocity).
- (c) Height includes standard 2.5-inch base frame for sizes 3-57 and 6-inch base frame for sizes 66-120.
- (d) Height includes 6-inch base frame for sizes 3-120.

Table 8. Dimensions — unit sizes 35 to 120

Unit size	35	40	50	57	66	80	100	120
Nominal airflow ^(a)	17,500	20,000	25,000	28,500	33,000	40,000	50,000	60,000
Airflow at 625 fpm ^(b)	23,263	25,519	34,375	39,581	47,225	53,475	65,106	76,388
Height - indoor unit ^(c)	67.25	67.25	75.75	85.50	92.50	107.50	119.75	119.75
Width	100.00	112.50	125.50	125.50	140.50	140.50	154.50	182.00
Height for outdoor unit includes base drip lip ^(d)	75	75	84.38	94.13	97.63	112.63	124.88	124.88

- (a) Nominal airflow is based on 500 fpm through a nominal coil (i.e. 500xunit size 8=4000 cfm).
- (b) Airflow@625 fpm through the flat filter (maximum filter velocity).
- (c) Height includes standard 2.5-inch base frame for sizes 3-57 and 6-inch base frame for sizes 66-120.
- (d) Height includes 6-inch base frame for sizes 3-120.

Unit Size 3

Table 9. Filter data for unit size 3

Filter Type	Area ft ²	Qty – Size (in.)
Flat (2-in., 4-in., and 2-in/4-in high efficiency) pleated, permanent, throwaway media)	3.47	1 - 20x25
Angled (2-in. or 4-in.) Pleated, permanent, throwaway media	5.56	2 - 16x25
Side load bag or cartridge	3.33	1 - 20x24
Front load bag or cartridge	2.00	1 - 12x24
Front load HEPA	2.00	1 - 12x24
TCAPS Module, Flat Side Load	3.33	1 - 24x24

Note: 2-inch filters available in permanent, throwaway, or pleated media; 4-inch filters available in pleated media, 65%, 85%, or 95% efficiency; Bag or cartridge filters available in 65%, 85%, or 95% efficiency.



General Data

Table 10. Coil availability — unit size 3

Section Type	3/8-in Unit Coils	1/2-in Unit Coils	5/8-in Unit Coils, 1/2-in and 5/8-in Modified Coils
Small	1-4 rows	2-4 rows	1-2 rows
Medium	1-8 rows	2-8 rows	1-4 rows
Extended-medium	1-8 rows	2-8 rows	1-8 rows
Medium-large	1-8 rows	2-8 rows	1-10 rows
-with access	1-6 rows	2-6 rows	1-3 rows
Large horizontal	1-8 rows	2-8 rows	1-10 rows
-with access	1-8 rows	2-8 rows	1-6 rows
Large vertical	1-8 rows	2-8 rows	1-6 rows
-with access	1-8 rows	2-8 rows	1-4 rows

Table 11. Coil data for unit size 3

Coil Type	Rows	Fin Type	Area ft ²	Qty – Size (in.)
3/8-inch unit coils				
-3W, 3F	1, 2, 4, 6, 8	Aluminum	2.92	1 - 20 × 21
1/2-inch unit coils				
-UA, UW, UF, UP	2, 4, 6, 8	Aluminum	2.92	1 - 20 × 21
5/8-inch unit coils				
-W, 5W, D1, TT	1, 2, 3, 4, 6, 8, 10	Aluminum or Copper	2.50	1 - 18 × 20
-WD, D2	6, 8, 10	Aluminum or Copper	2.38	1 - 18 × 19
1-inch unit coil				
-NS	1	Aluminum or Copper	2.50	1 - 18 × 20
1/2-inch modified coil				
-WL, WP	2, 4, 6, 8	Aluminum	1.74	1 - 12.50 × 20
5/8-inch modified coils				
-W, 5W, D1, TT	1, 2, 3, 4, 6, 8, 10	Aluminum or Copper	1.67	1 - 12 × 20
1-inch modified coil				
-NS	1	Aluminum or Copper	1.67	1 - 12 × 20

Unit Size 4

Table 12. Filter data for unit size 4

Filter Type	Area ft ²	Qty – Size (in.)
Flat (2-in., 4-in., and 2-in/4-in high efficiency) pleated, permanent, throwaway media	5.56	2 - 20 × 20
Angled (2-in. or 4-in.) pleated, permanent, throwaway media	8.89	4 - 16 × 20
Side load bag or cartridge	5.56	2 - 20 × 20
Front load bag or cartridge	2.00	1 - 12 × 24
Front load HEPA	2.00	1 - 12 × 24
TCAPS Module, Flat Side Load	5.56	2 - 20 × 20

Note: 2-inch filters available in permanent, throwaway, or pleated media; 4-inch filters available in pleated media, 65%, 85%, or 95% efficiency; Bag or cartridge filters available in 65%, 85%, or 95% efficiency.

Table 13. Coil availability — unit size 4

Section Type	3/8-in Unit Coils	1/2-in Unit Coils	5/8-in Unit Coils, 1/2-in and 5/8-in Modified Coils
Small	1-4 rows	2-4 rows	1-2 rows
Medium	1-8 rows	2-8 rows	1-4 rows
Extended-medium	1-8 rows	2-8 rows	1-8 rows
Medium-large	1-8 rows	2-8 rows	1-10 rows
-with access	1-6 rows	2-6 rows	1-3 rows
Large horizontal	1-8 rows	2-8 rows	1-10 rows
-with access	1-8 rows	2-8 rows	1-6 rows
Large vertical	1-8 rows	2-8 rows	1-6 rows
-with access	1-8 rows	2-8 rows	1-4 rows

Table 14. Coil data for unit size 4

Coil Type	Rows	Fin Type	Area ft ²	Qty – Size (in.)
3/8-inch unit coils				
-3W, 3F	1, 2, 4, 6, 8	Aluminum	4.51	1 - 20 × 32.50
1/2-inch unit coils				
-UA, UW, UF, UP	1, 2, 4, 6, 8	Aluminum	4.51	1 - 20 × 32.50
5/8-inch unit coils				
-W, 5W, D1, TT	1, 2, 3, 4, 6, 8, 10	Aluminum or Copper	4.00	1 - 18 × 32
-WD, D2	6, 8, 10	Aluminum or Copper	3.88	1 - 18 × 31
1-inch unit coil				
-NS	1	Aluminum or Copper	4.00	1 - 18 × 32
1/2-inch modified coil				
-WL, WP	1, 2, 4, 6, 8	Aluminum	2.78	1 - 12.50 × 32
5/8-inch modified coils				
-W, 5W, D1, TT	1, 2, 3, 4, 6, 8, 10	Aluminum or Copper	2.67	1 - 12 × 32
1-inch modified coil				
-NS	1	Aluminum or Copper	2.67	1 - 12 × 32

Unit Size 6

Table 15. Filter data for unit size 6

Filter Type	Area ft ²	Qty – Size (in.)
Flat (2-in., 4-in., and 2-in/4-in high efficiency) pleated, permanent, throwaway media	5.56	2 - 20 x 25
Angled (2-in. or 4-in.) Pleated, permanent, throwaway media	8.89	4 - 16 x 20
Side load bag or cartridge	6.67	2 - 24 x 20
Front load bag or cartridge	6.00	1 - 24 x 241 - 24 x 12
Front load HEPA	6.00	1 - 24 x 241 - 24 x 12
TCAPS Module, Flat Side Load	6.67	2 - 20 x 24

Note: 2-inch filters available in permanent, throwaway, or pleated media; 4-inch filters available in pleated media, 65%, 85%, or 95% efficiency; Bag or cartridge filters available in 65%, 85%, or 95% efficiency.



General Data

Table 16. Coil availability — unit size 6

Section Type	3/8-in Unit Coils	1/2-in Unit Coils	5/8-in Unit Coils, 1/2-in and 5/8-in Modified Coils
Small	1-4 rows	2-4 rows	1-2 rows
Medium	1-8 rows	2-8 rows	1-4 rows
Extended-medium	1-8 rows	2-8 rows	1-8 rows
Medium-large	1-8 rows	2-8 rows	1-10 rows
-with access	1-6 rows	2-6 rows	1-3 rows
Large horizontal	1-8 rows	2-8 rows	1-10 rows
-with access	1-8 rows	2-8 rows	1-6 rows
Large vertical	1-8 rows	2-8 rows	1-6 rows
-with access	1-8 rows	2-8 rows	1-4 rows

Table 17. Coil data for unit size 6

Coil Type	Rows	Fin Type	Area ft ²	Qty – Size (in.)
3/8-inch unit coils				
-3W, 3F	1, 2, 4, 6, 8	Aluminum	6.05	1 - 26 x 33.50
1/2-inch unit coils				
-UA, UW, UF, UP	1, 2, 4, 6, 8	Aluminum	6.11	1 - 26.25 x 33.50
5/8-inch unit coils				
-W, 5W, D1, TT	1, 2, 3, 4, 6, 8, 10	Aluminum or Copper	5.33	1 - 24 x 32
-WD, D2	6, 8, 10	Aluminum or Copper	5.17	1 - 24 x 31
1-inch unit coil				
-NS	1	Aluminum or Copper	5.33	1 - 24 x 32
1/2-inch modified coil				
-WL, WP	1, 2, 4, 6, 8	Aluminum	2.78	1 - 12.50 x 32
5/8-inch modified coils				
-W, 5W, D1, TT	1, 2, 3, 4, 6, 8, 10	Aluminum or Copper	2.67	1 - 12 x 32
1-inch modified coil				
-NS	1	Aluminum or Copper	2.67	1 - 12 x 32

Unit Size 8

Table 18. Filter data for unit size 8

Filter Type	Area ft ²	Qty – Size (in.)
Flat (2-in., 4-in., and 2-in/4-in high efficiency) pleated, permanent, throwaway media	7.33	1 - 24 x 20 1 - 24 x 24
Angled (2-in. or 4-in.) Pleated, permanent, throwaway media	11.11	4 - 20 x 20
Side load bag or cartridge	8.00	4 - 24 x 12
Front load bag or cartridge	6.00	1 - 24 x 24 1 - 24 x 12
Front load HEPA	7.00	1 - 24 x 30 1 - 24 x 12

Table 18. Filter data for unit size 8 (continued)

Filter Type	Area ft ²	Qty – Size (in.)
TCAPS Module, Flat Side Load	8.00	4 - 12 x 24

Note: 2-inch filters available in permanent, throwaway, or pleated media; 4-inch filters available in pleated media, 65%, 85%, or 95% efficiency; Bag or cartridge filters available in 65%, 85%, or 95% efficiency

Table 19. Coil availability — unit size 8

Section Type	3/8-in Unit Coils	1/2-in Unit Coils	5/8-in Unit Coils, 1/2-in and 5/8-in Modified Coils
Small	1-4 rows	2-4 rows	1-2 rows
Medium	1-8 rows	2-8 rows	1-4 rows
Extended-medium	1-8 rows	2-8 rows	1-8 rows
Medium-large	1-8 rows	2-8 rows	1-10 rows
-with access	1-6 rows	2-6 rows	1-3 rows
Large horizontal	1-8 rows	2-8 rows	1-10 rows
-with access	1-8 rows	2-8 rows	1-6 rows
Large vertical	1-8 rows	2-8 rows	1-6 rows
-with access	1-8 rows	2-8 rows	1-6 rows

Table 20. Coil data for unit size 8

Coil Type	Rows	Fin Type	Area ft ²	Qty–Size (in.)
3/8-inch unit coils				
-3W, 3U, 3F	1, 2, 4, 6, 8	Aluminum	7.58	1-28 x 39
1/2-inch unit coils				
-UA, UW, UF, UP	1, 2, 4, 6, 8	Aluminum	7.99	1-28.75 x 40
5/8-inch unit coils				
-W, 5W, D1	1, 2, 3, 4, 6, 8, 10	Aluminum or Copper	7.31	1-27 x 39
-WD, D2	6, 8, 10	Aluminum or Copper	7.13	1-27 x 38
-TT	1, 2, 4, 6, 8	Aluminum or Copper	6.50	1-24 x 39
1-inch unit coil				
-NS	1	Aluminum or Copper	6.50	1-24 x 39
1/2-inch modified coils				
-WL, LL, FD, WP	2, 4, 6, 8	Aluminum	4.95	1-18.75 x 38
5/8-inch modified coils				
-W, 5W, D1, TT	1, 2, 3, 4, 6, 8, 10	Aluminum or Copper	4.88	1-18 x 39
-WD, D2	6, 8, 10	Aluminum or Copper	4.75	1-18 x 38
1-inch modified coil				
-NS	1	Aluminum or Copper	4.88	1-18 x 39



General Data

Unit Size 10

Table 21. Filter data for unit size 10

Filter Type	Area ft ²	Qty – Size (in.)
Flat (2-in., 4-in., and 2-in/4-in high efficiency) pleated, permanent, throwaway media	9.72	2 - 20 x 25 1 - 16 x 25
Angled (2-in. or 4-in.) pleated, permanent, throwaway media	13.89	4 - 25 x 20
Side load bag or cartridge	8.67	2 - 24 x 20 1 - 24 x 12
Front load bag or cartridge	8.00	2 - 24 x 24
Front load HEPA	9.00	1 - 24 x 30 1 - 24 x 24
TCAPS Module, Flat Side Load	8.67	1 - 12 x 24 2 - 20 x 24

Note: 2-inch filters available in permanent, throwaway, or pleated media; 4-inch filters available in pleated media, 65%, 85%, or 95% efficiency; Bag or cartridge filters available in 65%, 85%, or 95% efficiency.

Table 22. Coil availability — size 10

Section Type	3/8-in Unit Coils	1/2-in Unit Coils	5/8-in Unit Coils, 1/2-in and 5/8-in Modified Coils
Small	1-4 rows	2-4 rows	1-2 rows
Medium	1-8 rows	2-8 rows	1-4 rows
Extended-medium	1-8 rows	2-8 rows	1-8 rows
Medium-large	1-8 rows	2-8 rows	1-10 rows
-with access	1-6 rows	2-6 rows	1-3 rows
Large horizontal	1-8 rows	2-8 rows	1-10 rows
-with access	1-8 rows	2-8 rows	1-6 rows
Large vertical	1-8 rows	2-8 rows	1-6 rows
-with access	1-8 rows	2-8 rows	1-6 rows

Table 23. Coil data for unit size 10

Coil Type	Rows	Fin Type	Area ft ²	Qty – Size (in.)
3/8-inch unit coils				
-3W, 3U, 3F	1, 2, 4, 6, 8	Aluminum	9.72	1 - 28 x 50
1/2-inch unit coils				
-UA, UW, UF, UP	1, 2, 4, 6, 8	Aluminum	9.98	1 - 28.75 x 50
5/8-inch unit coils				
-W, WD, 5W, D1, D2	1, 2, 3, 4, 6, 8, 10	Aluminum or Copper	9.19	1 - 27 x 49
-TT, P2, P4, P8	1, 2, 4, 6, 8	Aluminum or Copper	8.17	1 - 24 x 49
1-inch unit coil				
-NS	1	Aluminum or Copper	8.17	1 - 24 x 49
1/2-inch modified coils				
-WL, LL, FD, WP	2, 4, 6, 8	Aluminum	6.38	1 - 18.75 x 49
5/8-inch modified coils				
-W, 5W, WD, D1, D2, TT	1, 2, 3, 4, 6, 8, 10	Aluminum or Copper	6.13	1 - 18 x 49

Table 23. Coil data for unit size 10 (continued)

Coil Type	Rows	Fin Type	Area ft ²	Qty – Size (in.)
1-inch modified coil				
-NS	1	Aluminum or Copper	6.13	1 - 18 x 49

Unit Size 12

Table 24. Filter data for unit size 12

Filter Type	Area ft ²	Qty – Size (in.)
Flat (2-in., 4-in., and 2-in/4-in high efficiency) pleated, permanent, throwaway media	13.33	3 - 16 x 20 3 - 16 x 20
Angled (2-in. or 4-in.) pleated, permanent, throwaway media	16.67	6 - 20 x 20
Side load bag or cartridge	12.33	3 - 20 x 20 2 - 12 x 24
Front load bag or cartridge	10.00	1 - 12 x 24 2 - 24 x 24
Front load HEPA	10.00	2 - 30 x 24
TCAPS Module, Flat Side Load	12.33	2 - 12 x 24 3 - 20 x 20

Note: 2-inch filters available in permanent, throwaway, or pleated media; 4-inch filters available in pleated media, 65%, 85%, or 95% efficiency; Bag or cartridge filters available in 65%, 85%, or 95% efficiency.

Table 25. Coil availability — size 12

Section Type	3/8-in Unit Coils	1/2-in Unit Coils	5/8-in Unit Coils, 1/2-in and 5/8-in Modified Coils
Small	1-4 rows	2-4 rows	1-2 rows
Medium	1-8 rows	2-8 rows	1-4 rows
Extended-medium	1-8 rows	2-8 rows	1-8 rows
Medium-large	1-8 rows	2-8 rows	1-10 rows
-with access	1-6 rows	2-6 rows	1-3 rows
Large horizontal	1-8 rows	2-8 rows	1-10 rows
-with access	1-8 rows	2-8 rows	1-6 rows
Large vertical	1-8 rows	2-8 rows	1-6 rows
-with access	1-8 rows	2-8 rows	1-6 rows

Table 26. Coil data for unit size 12

Coil Type	Rows	Fin Type	Area ft ²	Qty – Size (in.)
3/8-inch unit coils				
-3W, 3U, 3F	1, 2, 4, 6, 8	Aluminum	12.11	1 - 32 x 54.50
1/2-inch unit coils				
-UA, UW, UF, UU, UP	1, 2, 4, 6, 8	Aluminum	12.30	1 - 32.50 x 54.50
5/8-inch unit coils				
-W, WD, D1, D2	4, 6, 8, 10	Aluminum or Copper	11.81	1 - 31.50 x 54
-W, 5W, D1, TT	1, 2, 3, 4, 6, 8	Aluminum or Copper	11.25	1 - 30 x 54
1-inch unit coil				



General Data

Table 26. Coil data for unit size 12 (continued)

Coil Type	Rows	Fin Type	Area ft ²	Qty – Size (in.)
-NS	1	Aluminum or Copper	11.25	1 - 30 × 54
1/2-inch modified coils				
-WL, LL, FD, WP	2, 4, 6, 8	Aluminum	9.38	1-25 × 54
5/8-inch modified coils				
-W, WD, 5W, D1, D2, TT	1, 2, 3, 4, 6, 8, 10	Aluminum or Copper	9.00	1 - 24 × 54
1-inch modified coil				
-NS	1	Aluminum or Copper	9.00	1 - 24 × 54

Unit Size 14

Table 27. Filter data for unit size 14

Filter Type	Area ft ²	Qty – Size (in.)
Flat (2-in., 4-in., and 2-in/4-in high efficiency) pleated, permanent, throwaway media	14.44	4 - 16 × 20 2 - 16 × 25
Angled (2-in. or 4-in.) pleated, permanent, throwaway media	18.06	2 - 20 × 25 4 - 20 × 20
Side load bag or cartridge	13.44	2 - 20 × 24 1 - 20 × 20 2 - 12 × 24
Front load bag or cartridge	10.00	1 - 12 × 24 2 - 24 × 24
Front load HEPA	10.00	2 - 30 × 24
TCAPS Module, Flat Side Load	13.44	2 - 12 × 24 1 - 20 × 20 2 - 20 × 24

Note: 2-inch filters available in permanent, throwaway, or pleated media; 4-inch filters available in pleated media, 65%, 85%, or 95% efficiency; Bag or cartridge filters available in 65%, 85%, or 95% efficiency.

Table 28. Coil availability — size 14

Section Type	3/8-in Unit Coils	1/2-in Unit Coils	5/8-in Unit Coils, 1/2-in and 5/8-in Modified Coils
Small	1-4 rows	2-4 rows	1-2 rows
Medium	1-8 rows	2-8 rows	1-4 rows
Extended-medium	1-8 rows	2-8 rows	1-8 rows
Medium-large	1-8 rows	2-8 rows	1-10 rows
-with access	1-6 rows	2-6 rows	1-3 rows
Large horizontal	1-8 rows	2-8 rows	1-10 rows
-with access	1-8 rows	2-8 rows	1-6 rows
Large vertical	1-8 rows	2-8 rows	1-6 rows
-with access	1-8 rows	2-8 rows	1-6 rows

Table 29. Coil data for unit size 14

Coil Type	Rows	Fin Type	Area ft ²	Qty – Size (in.)
3/8-inch unit coils				
-3W, 3U, 3F	1, 2, 4, 6, 8	Aluminum	13.44	1 - 32 × 60.50

Table 29. Coil data for unit size 14 (continued)

Coil Type	Rows	Fin Type	Area ft ²	Qty – Size (in.)
1/2-inch unit coils				
-UA, UW, UF, UU, UP	1, 2, 4, 6, 8	Aluminum	13.65	1 - 32.50 x 60.50
5/8-inch unit coils				
-W, D1	4, 6, 8, 10	Aluminum or Copper	13.13	1 - 31.50 x 60
W, 5W, D1, TT, P2, P4, P8	1, 2, 3, 4, 6, 8	Aluminum or Copper	12.50	1 - 30 x 60
-WD, D2	6, 8, 10	Aluminum or Copper	12.91	1 - 31.50 x 59
1-inch unit coil				
-NS	1	Aluminum or Copper	12.50	1 - 30 x 60
1/2-inch modified coils				
-WL, LL, FD, WP	2, 4, 6, 8	Aluminum	10.42	1 - 25 x 60
5/8-inch modified coils				
-W, 5W, D1, TT	1, 2, 3, 4, 6, 8, 10	Aluminum or Copper	10.00	1 - 24 x 60
-WD, D2	6, 8, 10	Aluminum or Copper	9.83	1 - 24 x 59
-WD	6, 8	Copper	9.83	1 - 24 x 59
1-inch modified coil				
-NS	1	Aluminum or Copper	10.00	1 - 24 x 60

Unit Size 17

Table 30. Filter data for unit size 17

Filter Type	Area ft ²	Qty – Size (in.)
Flat (2-in., 4-in., and 2-in/4-in high efficiency) pleated, permanent, throwaway media	18.89	4 - 20 x 24 2 - 20 x 20
Angled (2-in. or 4-in.) Pleated, permanent, throwaway media	28.89	4 - 16 x 25 8 - 16 x 20
Side load bag or cartridge	18.89	4 - 20 x 24 2 - 20 x 20
Front load bag or cartridge	14.00	3 - 12 x 24 2 - 24 x 24
Front load HEPA	14.00	2 - 24 x 30 2 - 12 x 24
TCAPS Module, Flat Side Load	18.89	4 - 20 x 24 2 - 20 x 20

Note: 2-inch filters available in permanent, throwaway, or pleated media; 4-inch filters available in pleated media, 65%, 85%, or 95% efficiency; Bag or cartridge filters available in 65%, 85%, or 95% efficiency.

Table 31. Coil availability — size 17

Section Type	3/8-in Unit Coils	1/2-in Unit Coils	5/8-in Unit Coils, 1/2-in and 5/8-in, Modified Coils
Small	1-4 rows	2-4 rows	1-2 rows
Medium	1-8 rows	2-8 rows	1-4 rows
Extended-medium	1-8 rows	2-8 rows	1-8 rows
Medium-large	1-8 rows	2-8 rows	1-10 rows



General Data

Table 31. Coil availability — size 17 (continued)

Section Type	3/8-in Unit Coils	1/2-in Unit Coils	5/8-in Unit Coils, 1/2-in and 5/8-in, Modified Coils
-with access	1-6 rows	2-6 rows	1-3 rows
Large horizontal	1-8 rows	2-8 rows	1-10 rows
-with access	1-8 rows	2-8 rows	1-6 rows
Large vertical	1-8 rows	2-8 rows	1-6 rows
-with access	1-8 rows	2-8 rows	1-6 rows

Table 32. Coil data for unit size 17

Coil Type	Rows	Fin Type	Area ft ²	Qty – Size (in.)
3/8-inch unit coils				
-3W, 3U, 3F	1, 2, 4, 6, 8	Aluminum	16.81	1 - 40 x 60.50
1/2-inch unit coils				
-UA, UW, UF, UU, UP	1, 2, 4, 6, 8	Aluminum	16.81	1 - 40 x 60.50
5/8-inch unit coils				
-D1	4, 6, 8	Aluminum or Copper	15.63	1 - 37.50 x 60
-W, D1	4, 6, 8, 10	Aluminum	15.63	1 - 37.50 x 60
-W, D1	4, 6, 8	Copper	15.63	1 - 37.50 x 60
-WD, D2	6, 8	Aluminum or Copper	15.36	1 - 37.50 x 59
-WD, D2	10	Aluminum	15.36	1 - 37.50 x 59
-WD, D2	8	Copper	15.36	1 - 37.50 x 59
-W, 5W, D1	1, 2, 3	Aluminum or Copper	15.00	1 - 36 x 60
-TT	2	Aluminum or Copper	13.75	1 - 33 x 60
1-inch unit coil				
-NS	1	Aluminum or Copper	13.75	1 - 33 x 60
1/2-inch modified coils				
-WL, LL, FD, WP	2, 4, 6, 8	Aluminum	13.02	1 - 31.25 x 60
5/8-inch modified coils				
-W, 5W, D1, TT	1, 2, 3, 4, 6, 8, 10	Aluminum or Copper	12.50	1 - 30 x 60
-WD, D2	6, 8, 10	Aluminum or Copper	12.29	1 - 30 X 59
1-inch modified coil				
-NS	1	Aluminum or Copper	12.50	1 - 30 x 60

Unit Size 21

Table 33. Filter data for unit size 21

Filter Type	Area ft ²	Qty – Size (in.)
Flat (2-in., 4-in., and 2-in/4-in high efficiency) pleated, permanent, throwaway media	21.53	3 - 25 x 20 1 - 25 x 16 3 - 16 x 25
Angled (2-in. or 4-in.) Pleated, permanent, throwaway media	33.33	12 - 25 x 16
Side load bag or cartridge	22.00	3 - 24 x 24 3 - 20 x 24

Table 33. Filter data for unit size 21 (continued)

Filter Type	Area ft ²	Qty – Size (in.)
Front load bag or cartridge	18.00	3 - 12 x 24 3 - 24 x 24
Front load HEPA	21.00	3 - 30 x 24 3 - 12 x 24
TCAPS Module, Flat Side Load	22.00	3 - 20 x 24 3 - 24 x 24

Note: 2-inch filters available in permanent, throwaway, or pleated media; 4-inch filters available in pleated media, 65%, 85%, or 95% efficiency; Bag or cartridge filters available in 65%, 85%, or 95% efficiency.

Table 34. Coil availability — size 21

Section Type	3/8-in Unit Coils	1/2-in Unit Coils	5/8-in Unit Coils, 1/2-in and 5/8-in Modified Coils
Small	1-4 rows	2-4 rows	1-2 rows
Medium	1-8 rows	2-8 rows	1-4 rows
Extended-medium	1-8 rows	2-8 rows	1-8 rows ^(a)
Medium-large	1-8 rows	2-8 rows	1-10 rows
-with access	1-6 rows	2-6 rows	1-4 rows
Large horizontal	1-8 rows	2-8 rows	1-10 rows
-with access	1-8 rows	2-8 rows	1-6 rows
Large vertical	1-8 rows	2-8 rows	1-6 rows
-with access	1-8 rows	2-8 rows	1-4 rows

^(a) 6-row maximum for stacked coils.

Table 35. Coil data for unit size 21

Coil Type	Rows	Fin Type	Area ft ²	Qty – Size (in.)
3/8-inch unit coils				
-3W, 3U, 3F	1, 2, 4, 6, 8	Aluminum	20.42	1 - 43 x 68.50
1/2-inch unit coils				
-UA, UW, UF, UU, UP	1, 2, 4, 6, 8	Aluminum	20.81	1 - 43.75 x 68.50
5/8-inch unit coils				
-W, 5W, D1, D2	1, 2, 3, 4, 6, 8	Aluminum or Copper	19.83	1 - 42 x 68
-W, D1	4, 6, 8, 10	Aluminum	19.83	1 - 42 x 68
-W, WD, D1, D2	4, 6, 8	Copper	19.83	1 - 42 x 68
-WD, D2	6, 8	Aluminum or Copper	19.54	1 - 42 x 67
-D2, WD	10	Aluminum	19.54	1 - 42 x 67
-TT (stacked)	1, 2, 4, 6, 8	Aluminum or Copper	17.00	2 - 18 x 68
1-inch unit coil				
-NS (stacked)	1	Aluminum or Copper	17.00	2 - 18 x 68
1/2-inch modified coils				
-WL, LL, FD, WP	2, 4, 6, 8	Aluminum	15.94	1 - 33.75 x 68
5/8-inch modified coils				
-W, 5W, D1, TT	1, 2, 3, 4, 6, 8, 10 ^(a)	Aluminum or Copper	15.58	1 - 33 x 68



General Data

Table 35. Coil data for unit size 21 (continued)

Coil Type	Rows	Fin Type	Area ft ²	Qty – Size (in.)
-D2	6, 8, 10 ^(a)	Aluminum or Copper	15.35	1 - 33 x 67
-WD	6, 8, 10	Aluminum	15.35	1 - 33 x 67
-WD	6, 8	Copper	15.35	1 - 33 x 67
1-inch modified coil				
-NS	1	Aluminum or Copper	15.58	1 - 33 x 68

^(a) Copper not available for 10 row

Unit Size 25

Table 36. Filter data for unit size 25

Filter Type	Area ft ²	Qty – Size (in.)
Flat (2-in., 4-in., and 2-in/4-in high efficiency) pleated, permanent, throwaway media	27.11	6 - 20 x 20 2 - 20 x 16 3 - 12 x 24
Angled (2-in. or 4-in.) Pleated, permanent, throwaway media	50.00	18 - 25 x 16
Side load bag or cartridge	26.00	6 - 20 x 24 3 - 12 x 24
Front load bag or cartridge	24.00	6 - 24 x 24
Front load HEPA	24.00	2 - 24 x 30 1 - 24 x 12 2 - 24 x 30 1 - 24 x 12
TCAPS Module, Flat Side Load	26.00	3 - 12 x 24 6 - 20 x 24

Note: 2-inch filters available in permanent, throwaway, or pleated media; 4-inch filters available in pleated media, 65%, 85%, or 95% efficiency; Bag or cartridge filters available in 65%, 85%, or 95% efficiency.

Table 37. Coil availability — size 25

Section Type	3/8-in Unit Coils	1/2-in Unit Coils	5/8-in Unit Coils 1/2-in and 5/8-in Modified Coils
Small	1-4 rows	2-4 rows	1-2 rows
Medium	1-8 rows	2-8 rows	1-4 rows
Extended-medium	1-8 rows	2-8 rows	1-8 rows ^(a)
Medium-large	1-8 rows	2-8 rows	1-10 rows ^{(a)\}
-with access	1-6 rows	2-6 rows	1-3 rows
Large horizontal	1-8 rows	2-8 rows	1-10 rows
-with access	1-8 rows	2-8 rows	1-10 rows
Large vertical	1-8 rows	2-8 rows	1-10 rows
-with access	1-8 rows	2-8 rows	1-10 rows

^(a) 6-row maximum for stacked coils.

Table 38. Coil data for unit size 25

Coil Type	Rows	Fin Type	Area ft ²	Qty – Size (in.)
3/8-inch unit coils				
-3W, 3U, 3F	1, 2, 4, 6, 8	Aluminum	24.74	1 - 52 x 68.50

Table 38. Coil data for unit size 25 (continued)

Coil Type	Rows	Fin Type	Area ft ²	Qty – Size (in.)
1/2-inch unit coils				
-UA, UW, UF, UU, UP	1, 2, 4, 6, 8	Aluminum	24.97	1 - 52.50 x 68.50
5/8-inch unit coils				
-W, 5W, D1	1, 2, 3, 4, 6, 8	Aluminum or Copper	24.08	1 - 51 x 68
-W, D1	4, 6, 8, 10	Aluminum	24.08	1 - 51 x 68
-W, WD, 5D, D1, D2	4, 6, 8	Copper	24.08	1 - 51 x 68
WD, 5D, D2	6, 8, 10	Aluminum or Copper	23.73	1 - 51 x 67
-TT (stacked)	1, 2, 4, 6, 8	Aluminum or Copper	22.67	2 - 24 x 68
1-inch unit coil				
-NS (stacked)	1	Aluminum or Copper	22.67	2 - 24 x 68
1/2-inch modified coils				
-WL, LL, FD, WP	2, 4, 6, 8	Aluminum	17.12	1 - 36.25 x 68
5/8-inch modified coils				
-W, 5A, 5W, D1	1, 2, 3, 4, 6, 8	Aluminum or Copper	17.00	1 - 36 x 68
-W, D1	10	Aluminum	17.00	1 - 36 x 68
-W, WD, D1, D2	8	Copper	17.00	1 - 36 x 68
-D2	6, 8	Aluminum or Copper	16.75	1 - 36 x 67
-D2, WD	6, 8, 10	Aluminum	16.75	1 - 36 x 67
-WD	6, 8	Copper	16.75	1 - 36 x 67
-TT (stacked)	1, 2, 4, 6, 8	Aluminum or Copper	17.00	2 - 18 x 68
1-inch modified coil				
-NS (stacked)	1	Aluminum or Copper	17.00	2 - 18 x 68
Multizone coils				
5W, NS, TT	1, 2	Aluminum or Copper	11.00	1 - 24 x 68
-WL, WP	2	Aluminum	11.33	1 - 24 x 68

Unit Size 30

Table 39. Filter data for unit size 30

Filter Type	Area ft ²	Qty – Size (in.)
Flat (2-in., 4-in., and 2-in/4-in high efficiency) pleated, permanent, throwaway media	30.44	6 - 20 x 24 2 - 20 x 16 3 - 12 x 24
Angled (2-in. or 4-in.) Pleated, permanent, throwaway media	56.67	6 - 16 x 251 8 - 16 x 20
Side load bag or cartridge	28.22	8 - 20 x 20 3 - 12 x 24
Front load bag or cartridge	28.00	6 - 24 x 24 2 - 12 x 24
Front load HEPA	28.00	2 - 24 x 30 1 - 24 x 24 2 - 24 x 30 1 - 24 x 24



General Data

Table 39. Filter data for unit size 30 (continued)

Filter Type	Area ft ²	Qty – Size (in.)
TCAPS Module, Flat Side Load	28.22	3 - 12 x 24 8 - 20 x 20

Note: 2-inch filters available in permanent, throwaway, or pleated media; 4-inch filters available in pleated media, 65%, 85%, or 95% efficiency; Bag or cartridge filters available in 65%, 85%, or 95% efficiency.

Table 40. Coil availability — size 30

Section Type	3/8-in Unit Coils	1/2-in Unit Coils	5/8-in Unit Coils, 1/2-in and 5/8-in Modified Coils
Small	1-4 rows	2-4 rows	1-2 rows
Medium	1-8 rows	2-8 rows	1-4 rows
Extended-medium	1-8 rows	2-8 rows	1-8 ^(a) rows
Medium-large	1-8 rows	2-8 rows	1-10 ^(a) rows
-with access	1-6 rows	2-6 rows	1-3 rows
Large horizontal	1-8 rows	2-8 rows	1-10 rows
-with access	1-8 rows	2-8 rows	1-10 ^(a) rows
Large vertical	1-8 rows	2-8 rows	1-10 rows
-with access	1-8 rows	2-8 rows	1-10 rows

^(a) 6-row maximum for stacked coils.

Table 41. Coil data for unit size 30

Coil Type	Rows	Fin Type	Area ft ²	Qty – Size (in.)
3/8-inch unit coils				
-3W, 3U, 3F	1, 2, 4, 6, 8	Aluminum	29.61	1 - 52 x 82
1/2-inch unit coils				
-UA, UW, UF, UU, UP	1, 2, 4, 6, 8	Aluminum	29.90	1 - 52.50 x 82
5/8-inch unit coils				
-W, WD, 5D, 5W, D1, D2	1, 2, 3, 4, 6, 8	Aluminum or Copper	28.69	1 - 51 x 81
-W, WD, 5D, D1, D2	4, 6, 8, 10	Aluminum	28.69	1 - 51 x 81
-W, WD, 5D, D1, D2	4, 6, 8	Copper	28.69	1 - 51 x 81
-TT, P2, P4, P8 (stacked)	1, 2, 4, 6, 8	Aluminum or Copper	27.00	2 - 24 x 81
1-inch unit coil				
-NS (stacked)	1	Aluminum or Copper	27.00	2 - 24 x 81
1/2-inch modified coils				
-WL, LL, FD, WP	2, 4, 6, 8	Aluminum	20.39	1 - 36.25 x 81
5/8-inch modified coils				
-W, 5W, D1, D2	1, 2, 3, 4, 6, 8	Aluminum or Copper	20.25	1 - 36 x 81
-W, WD, D1, D2	6, 8, 10	Aluminum	20.25	1 - 36 x 81
-W, WD, D1, D2	8	Copper	20.25	1 - 36 x 81
-TT, P2, P4, P8 (stacked)	1, 2, 4, 6, 8	Aluminum or Copper	20.25	2 - 18 x 81
1-inch modified coil				
-NS (stacked)	1	Aluminum or Copper	20.25	2 - 18 x 81

Unit Size 35

Table 42. Filter data for unit size 35

Filter Type	Area ft ²	Qty – Size (in.)
Flat (2-in., 4-in., and 2-in/4-in high efficiency) pleated, permanent, throwaway media	37.22	8 - 20 x 24 3 - 16 x 25 1 - 16 x 20
Angled (2-in. or 4-in.) Pleated, permanent, throwaway media	63.33	18 - 16 x 25 6 - 16 x 20
Side load bag or cartridge	34.67	8 - 20 x 24 4 - 12 x 24
Front load bag or cartridge	34.00	5 - 12 x 24 6 - 24 x 24
Front load HEPA	30.00	3 - 24 x 30 3 - 30 x 24
TCAPS Module, Flat Side Load	34.67	4 - 12 x 24 8 - 20 x 24

Note: 2-inch filters available in permanent, throwaway, or pleated media; 4-inch filters available in pleated media, 65%, 85%, or 95% efficiency; Bag or cartridge filters available in 65%, 85%, or 95% efficiency.

Table 43. Coil availability — size 35

Section Type	1/2-in Unit Coils	5/8-in Unit Coils, 1/2-in and 5/8-in Modified Coils
Small	2-4 rows	1-2 rows
Medium	2-8 rows	1-4 rows
Extended-medium	2-8 rows	1-8 rows ^(a)
Medium-large	2-8 rows	1-10 rows
-with access	2-4 rows	1-3 rows
Large horizontal	2-8 rows	1-10 rows
-with access	2-8 rows	1-10 rows
Large vertical	2-8 rows	1-6 rows
-with access	2-8 rows	1-6 rows

^(a) 6-row maximum for stacked coils.

Table 44. Coil data for unit size 35

Coil Type	Rows	Fin Type	Area ft ²	Qty – Size (in.)
1/2-inch unit coils				
-UA, UW, UF, UU, UP	2, 4, 6, 8	Aluminum	34.94	1 - 57.50 x 87.50
5/8-inch unit coils				
-W, WD, 5D, D1, D2	4, 6, 8, 10	Aluminum or Copper	33.53	1 - 55.50 x 87
- W, 5W, D1	1, 2, 3	Aluminum or Copper	32.63	1 - 54 x 87
1-inch unit coil				
-NS (stacked)	1	Aluminum or Copper	30.81	1 - 33 x 87-18 x 87
1/2-inch modified coils				
-WL, LL, FD, WP	2, 4, 6, 8	Aluminum	21.90	1 - 36.25 x 87
5/8-inch modified coils				
-W, WD, 5W, D1, D2	1, 2, 3, 4, 6, 8, 10	Aluminum or Copper	21.75	1 - 36 x 87



General Data

Table 44. Coil data for unit size 35 (continued)

Coil Type	Rows	Fin Type	Area ft ²	Qty – Size (in.)
1-inch modified coil				
-NS (stacked)	1	Aluminum or Copper	21.75	2 - 18 x 87

Unit Size 40

Table 45. Filter data for unit size 40

Filter Type	Area ft ²	Qty – Size (in.)
Flat (2-in., 4-in., and 2-in/4-in high efficiency) pleated, permanent, throwaway media	40.83	8 - 20 x 20 2 - 20 x 25 4 - 16 x 20 1 - 16 x 25
Angled (2-in. or 4-in.) Pleated, permanent, throwaway media	70.00	6 - 16 x 25 24 - 16 x 20
Side load bag or cartridge	36.00	8 - 24 x 24 2 - 24 x 12
Front load bag or cartridge	40.00	4 - 12 x 24 8 - 24 x 24
Front load HEPA	37.00	3 - 24 x 30 1 - 24 x 12 4 - 30 x 24
TCAPS Module, Flat Side Load	36.00	8 - 24 x 24 2 - 12 x 24

Note: 2-inch filters available in permanent, throwaway, or pleated media; 4-inch filters available in pleated media, 65%, 85%, or 95% efficiency; Bag or cartridge filters available in 65%, 85%, or 95% efficiency.

Table 46. Coil availability — size 40

Section Type	1/2-in Unit Coils	5/8-in Unit Coils, 1/2-in and 5/8-in Modified Coils
Small	2-4 rows	1-2 rows
Medium	2-8 rows	1-4 rows
Extended-medium	2-8 rows	1-8 rows ^(a)
Medium-large	2-8 rows	1-10 rows
-with access	2-4 rows	1-3 rows
Large horizontal	2-8 rows	1-10 rows
-with access	2-8 rows	1-10 rows
Large vertical	2-8 rows	1-6 rows
-with access	2-8 rows	1-6 rows

^(a) 6-row maximum for stacked coils.

Table 47. Coil data for unit size 40

Coil Type	Rows	Fin Type	Area ft ²	Qty – Size (in.)
1/2-inch unit coils				
-UA, UW, UF, UU, UP	2, 4, 6, 8	Aluminum	39.93	1 - 57.50 x 100
5/8-inch unit coils				
-W, WD, D1, D2	4, 6, 8	Aluminum or Copper	38.54	1 - 55.50 x 100

Table 47. Coil data for unit size 40 (continued)

Coil Type	Rows	Fin Type	Area ft ²	Qty – Size (in.)
-W, WD, 5D, D1, D2	6, 8, 10	Aluminum	38.54	1 - 55.50 x 100
-W, 5W, D1	1, 2, 3	Aluminum or Copper	37.50	1 - 54 x 100
1-inch unit coil				
-NS (stacked)	1	Aluminum or Copper	35.42	1 - 33 x 1001-18 x 100
1/2-inch modified coils				
-WL, LL, FD, WP	2, 4, 6, 8	Aluminum	25.17	1 - 36.25 x 100
5/8-inch modified coils				
-W, WD, 5W, D1, D2	1, 2, 3, 4, 6, 8	Aluminum or Copper	25.00	1 - 36 x 100
-W, WD, D1, D2	10	Aluminum	25.00	1 - 36 x 100
1-inch modified coil				
-NS (stacked)	1	Aluminum or Copper	25.00	2 - 18 x 100

Unit Size 50

Table 48. Filter data for unit size 50

Filter Type	Area ft ²	Qty – Size (in.)
Flat (2-in., 4-in., and 2-in/4-in high efficiency) pleated, permanent, throwaway media	55.00	12 - 25 x 20 4 - 16 x 25 1 - 16 x 20
Angled (2-in. or 4-in.) Pleated, permanent, throwaway media	100.00	36 - 20 x 20
Side load bag or cartridge	50.00	10 - 24 x 24 5 - 12 x 24
Front load bag or cartridge	50.00	5 - 12 x 24 10 - 24 x 24
Front load HEPA	46.00	3 - 24 x 30 1 - 24 x 24 3 - 24 x 30 1 - 24 x 24 4 - 12 x 24
TCAPS Module, Flat Side Load	50.00	5 - 12 x 24 10 - 24 x 24

Note: 2-inch filters available in permanent, throwaway, or pleated media; 4-inch filters available in pleated media, 65%, 85%, or 95% efficiency; Bag or cartridge filters available in 65%, 85%, or 95% efficiency.

Table 49. Coil availability — size 50

Section Type	1/2-in Unit Coils	5/8-in Unit Coils, 1/2-in and 5/8-in Modified Coils
Small	2 rows	1-2 rows
Medium	2-4 rows	1-3 rows
Extended-medium	2-8 rows	1-6 rows
Medium-large	2-8 rows	1-8 rows
-with access	2-4 rows	—
Large horizontal	2-8 rows	1-8 rows
-with access	2-8 rows	1-10 rows



General Data

Table 49. Coil availability — size 50 (continued)

Section Type	1/2-in Unit Coils	5/8-in Unit Coils, 1/2-in and 5/8-in Modified Coils
Large vertical	2-8 rows	1-6 rows
-with access	2-8 rows	1-6 rows

Table 50. Coil data for unit size 50

Coil Type	Rows	Fin Type	Area ft ²	Qty – Size (in.)
1/2-inch unit coils				
-UA, UW, UF, UU, UP (stacked)	2, 4, 6, 8	Aluminum	49.05	2 - 31.25 x 113
5/8-inch unit coils				
-W, WD, D1, D2 (stacked)	4, 6, 8, 10	Aluminum	48.26	1 - 27 x 1131-34.50 x 113
-W, WD, D1, D2 (stacked)	4, 6, 8	Copper	48.26	1 - 27 x 1131-34.50 x 113
-W, 5W, D1 (stacked)	1, 2, 3	Aluminum or Copper	47.08	1 - 27 x 1131-33 x 113
5/8-inch staggered coils				
-W, WD, 5W, 5D, D1, D2	1, 2, 3, 4, 6, 8	Aluminum or Copper	58.08	2 - 27 x 682-34.50 x 68
-W, WD, 5W, 5D, D1, D2 (stacked)	10	Aluminum	58.08	2 - 27 x 682-34.50 x 68
1-inch unit coil				
-NS (stacked)	1	Aluminum or Copper	47.08	2 - 30 x 113
1/2-inch modified coils				
-WL, LL, FD, WP	2, 4, 6, 8	Aluminum	33.35	1 - 42.50 x 113
5/8-inch modified coils				
-W, WD, 5A, 5W, D1, D2	1, 2, 3, 4, 6, 8, 10	Aluminum or Copper	35.31	1 - 45 x 113
1-inch modified coil				
-NS (stacked)	1	Aluminum or Copper	32.96	1 - 24 x 1131-18 x 113

Unit Size 57

Table 51. Filter data for unit size 57

Filter Type	Area ft ²	Qty – Size (in.)
Flat (2-in., 4-in., and 2-in/4-in high efficiency) pleated, permanent, throwaway media	63.33	12 - 20 x 25 3 - 20 x 20 4 - 16 x 25 1 - 16 x 20
Angled (2-in. or 4-in.) Pleated, permanent, throwaway media	100.00	36 - 20 x 20
Side load bag or cartridge	60.00	15 - 24 x 24
Front load bag or cartridge	60.00	15 - 24 x 24
Front load HEPA	57.00	3 - 24 x 30 1 - 24 x 24 3 - 24 x 30 1 - 24 x 24 3 - 24 x 30 1 - 24 x 24
TCAPS Module, Flat Side Load	60.00	15 - 24 x 24

Note: 2-inch filters available in permanent, throwaway, or pleated media; 4-inch filters available in pleated media, 65%, 85%, or 95% efficiency; Bag or cartridge filters available in 65%, 85%, or 95% efficiency.

Table 52. Coil availability — size 57

Section Type	1/2-in Unit Coils	5/8-in Unit Coils, 1/2-in and 5/8-in Modified Coils
Small	2 rows	1-2 rows
Medium	2-4 rows	1-3 rows
Extended-medium	2-8 rows	1-6 rows
Medium-large	2-8 rows	1-8 rows
-with access	2-4 rows	—
Large horizontal	2-8 rows	1-8 rows
-with access	2-8 rows	1-10 rows

Table 53. Coil data for unit size 57

Coil Type	Rows	Fin Type	Area ft ²	Qty – Size (in.)
1/2-inch unit coils				
-UA, UW, UF, UU, UP (stacked)	2, 4, 6, 8	Aluminum	56.89	2 - 36.25 x 113
5/8-inch unit coils				
-W, WD, 5W, D1, D2 (stacked)	1, 2, 3, 4, 6, 8	Aluminum or Copper	56.50	2 - 36 x 113
-W, WD, D1, D2 (stacked)	10	Aluminum	56.50	2 - 36 x 113
1-inch unit coil				
-NS (stacked)	1	Aluminum or Copper	51.79	1 - 30 x 1132 - 18 x 113
1/2-inch modified coils				
-WL, LL, WP	2, 4, 6, 8	Aluminum	43.16	1 - 55 x 113
-FD (stacked)	4 to 6	Aluminum	44.14	1 - 31.25 x 1131 - 25 x 113
5/8-inch modified coils				
-W, WD, 5A, 5W, D1, D2	1, 2, 3, 4, 6, 8	Aluminum or Copper	42.38	1 - 54 x 113
-W, WD, D1, D2	10	Aluminum	42.38	1 - 54 x 113
1-inch modified coil				
-NS (stacked)	1	Aluminum or Copper	42.38	1 - 30 x 1131 - 24 x 113

Unit Size 66

Table 54. Filter data for unit size 66

Filter Type	Area ft ²	Qty – Size (in.)
Flat (2-in., 4-in., and 2-in/4-in high efficiency) pleated, permanent, throwaway media	75.56	20 - 20 x 24 4 - 20 x 16
Angled (2-in. or 4-in.) Pleated, permanent, throwaway media	113.33	36 - 20 x 20 6 - 16 x 20
Side load bag or cartridge	66.67	20 - 20 x 24
Front load bag or cartridge	66.00	3 - 12 x 24 15 - 24 x 24
Front load HEPA	66.00	4 - 24 x 30 1 - 24 x 12 4 - 24 x 30 1 - 24 x 12 4 - 24 x 30 1 - 24 x 12



General Data

Table 54. Filter data for unit size 66 (continued)

Filter Type	Area ft ²	Qty – Size (in.)
TCAPS Module, Flat Side Load	66.67	20 - 20 x 24

Note: 2-inch filters available in permanent, throwaway, or pleated media; 4-inch filters available in pleated media, 65%, 85%, or 95% efficiency; Bag or cartridge filters available in 65%, 85%, or 95% efficiency.

Table 55. Coil availability — size 66

Section Type	1/2-in Unit Coils	5/8-in Unit Coils 1/2-in and 5/8-in Modified Coils
Small	—	—
Medium	2-4 rows	1-3 rows
Extended-medium	2-8 rows	1-6 rows
Medium-large	2-8 rows	1-10 rows
-with access	—	—
Large horizontal	—	—
-with access	—	—
Large vertical	—	—
-with access	—	—

Table 56. Coil data for unit size 66

Coil Type	Rows	Fin Type	Area ft ²	Qty – Size (in.)
1/2-inch unit coils				
-UA, UW, UF, UU, UP (stacked)	2, 4, 6, 8	Aluminum	65.63	2 - 37.50 x 126
5/8-inch unit coils				
-W, WD, D1, D (stacked0)	4, 6, 8	Aluminum or Copper	65.63	2 - 37.50 x 126
-W, WD, D1, D2 (stacked)	10	Aluminum	65.63	2 - 37.50 x 126
-W, 5W, D1 (stacked)	1, 2, 3	Aluminum or Copper	65.63	1 - 42 x 126 1 - 33 x 126
1-inch unit coil				
-NS (stacked)	1	Aluminum or Copper	60.38	1 - 33 x 126 2 - 18 x 126
1/2-inch modified coils				
-WL, LL, FD, WP (stacked)	2, 4, 6, 8	Aluminum	51.41	1 - 33.75 x 126 1 - 25 x 126
5/8-inch modified coils				
-W, WD, 5W, D1, D2 (stacked)	1, 2, 3, 4, 6, 8	Aluminum or Copper	49.88	1 - 33 x 126 1 - 24 x 126
W, WD, D1, D2 (stacked)	10	Aluminum	49.88	1 - 33 x 126 1 - 24 x 126
1-inch modified coil				
-NS (stacked)	1	Aluminum or Copper	49.88	1 - 33 x 126 1 - 24 x 126

Unit Size 80

Table 57. Filter data for unit size 80

Filter Type	Area ft ²	Qty – Size (in.)
Flat (2-in., 4-in., and 2-in/4-in high efficiency) pleated, permanent, throwaway media	85.56	20 - 20 x 24 4 - 20 x 16 5 - 12 x 24
Angled (2-in. or 4-in.) Pleated, permanent, throwaway media	151.11	48 - 20 x 20 8 - 16 x 20
Side load bag or cartridge	88.00	20 - 24 x 24 4 - 24 x 12
Front load bag or cartridge	86.00	1 - 12 x 24 19 - 24 x 24 4 - 24 x 12
Front load HEPA	76.00	4 - 24 x 30 1 - 24 x 12 4 - 24 x 30 1 - 24 x 12 4 - 24 x 30 1 - 24 x 12 5 - 12 x 24
TCAPS Module, Flat Side Load	88.00	20 - 24 x 24 4 - 12 x 24

Note: 2-inch filters available in permanent, throwaway, or pleated media; 4-inch filters available in pleated media, 65%, 85%, or 95% efficiency; Bag or cartridge filters available in 65%, 85%, or 95% efficiency.

Table 58. Coil availability — size 80

Section Type	1/2-in Unit Coils	5/8-in Unit Coils 1/2-in and 5/8-in Modified Coils
Small	—	—
Medium	2-4 rows	1-3 rows
Extended-medium	2-8 rows	1-6 rows
Medium-large	2-8 rows	1-10 rows
-with access	—	—
Large horizontal	—	—
-with access	—	—
Large vertical	—	—
-with access	—	—

Table 59. Coil data for unit size 80

Coil Type	Rows	Fin Type	Area ft ²	Qty – Size (in.)
1/2-inch unit coils				
-UA, UW, UF, UU, UP (stacked)	2, 4, 6, 8	Aluminum	78.75	2 - 45 x 126
5/8-inch unit coils				
-W, WD, 5D, 5W, D1, D2 (stacked)	1, 2, 3, 4, 6, 8	Aluminum or Copper	78.75	2 - 45 x 126
-W, WD, 5D, D1, D2 (stacked)	10	Aluminum	78.75	2 - 45 x 126
1-inch unit coil				
-NS (stacked)	1	Aluminum or Copper	73.50	2 - 30 x 1261 - 24 x 126
1/2-inch modified coils				
-WL, LL, FD, WP (stacked)	2, 4, 6, 8	Aluminum	63.44	2 - 36.25 x 126



General Data

Table 59. Coil data for unit size 80 (continued)

Coil Type	Rows	Fin Type	Area ft ²	Qty – Size (in.)
5/8-inch modified coils				
-W, WD, 5W, D1, D2	1, 2, 3, 4, 6, 8	Aluminum or Copper	63.00	2 - 36 x 126
-W, WD, D1, D2	10	Aluminum	63.00	2 - 36 x 126
1-inch modified coil				
-NS (stacked)	1	Aluminum or Copper	60.38	2 - 18 x 1261 - 33 x 126

Unit Size 100

Table 60. Filter data for unit size 100

Filter Type	Area ft ²	Qty – Size (in.)
Flat (2-in., 4-in., and 2-in/4-in high efficiency) pleated, permanent, throwaway media	104.17	30 - 20 x 25
Angled (2-in. or 4-in.) Pleated, permanent, throwaway media	166.67	48 - 20 x 25
Side load bag or cartridge	113.33	28 - 24 x 20 4 - 24 x 12 6 - 12 x 24
Front load bag or cartridge	108.00	6 - 12 x 24 24 - 24 x 24
Front load HEPA	102.00	6 - 30 x 24 6 - 30 x 24 6 - 30 x 24 6 - 12 x 24
TCAPS Module, Flat Side Load	113.33	10 - 12 x 24 28 - 20 x 24

Note: 2-inch filters available in permanent, throwaway, or pleated media; 4-inch filters available in pleated media, 65%, 85%, or 95% efficiency; Bag or cartridge filters available in 65%, 85%, or 95% efficiency.

Table 61. Coil availability — size 100

Section Type	1/2-in Unit Coils	5/8-in Unit Coils 1/2-in and 5/8-in Modified Coils
Small	—	—
Medium	2-4 rows	1-3 rows
Extended-medium	2-8 rows	1-6 rows
Medium-large	2-8 rows	1-10 rows
-with access	—	—
Large horizontal	—	—
-with access	—	—
Large vertical	—	—
-with access	—	—

Table 62. Coil data for unit size 100

Coil Type	Rows	Fin Type	Area ft ²	Qty – Size (in.)
1/2-inch unit coils				
-UA, UW, UF, UU, UP (stacked)	2, 4, 6, 8	Aluminum	99.14	1 - 57.50 x 141 1 - 43.75 x 141
5/8-inch unit coils				

Table 62. Coil data for unit size 100 (continued)

Coil Type	Rows	Fin Type	Area ft ²	Qty – Size (in.)
-W, WD, 5D, 5W, D1, D2 (stacked)	1, 2, 3, 4, 6, 8	Aluminum or Copper	99.88	2 - 51 x 141
W, WD, 5D, D1, D2 (stacked)	10	Aluminum	99.88	2 - 51 x 141
1-inch unit coil				
-NS (stacked)	1	Aluminum or Copper	94.00	2 - 33 x 141 1 - 30 x 141
1/2-inch modified coils				
-WL, LL, FD, WP (stacked)	2, 4, 6, 8	Aluminum	77.11	1 - 42.50 x 141 1 - 36.25 x 141
5/8-inch modified coils				
-W, WD, 5A 5W, D1, D2 (stacked)	1, 2, 3, 4, 6, 8	Aluminum or Copper	76.38	1 - 42 x 141 1 - 36 x 141
W, WD, D1, D2 (stacked)	10	Aluminum	76.38	1 - 42 x 141 1 - 36 x 141
1-inch modified coil				
-NS	1	Aluminum or Copper	76.38	1-30 x 141 2-24 x 141

Unit Size 120

Table 63. Filter data for unit size 120

Filter Type	Area ft ²	Qty – Size (in.)
Flat (2-in., 4-in., and 2-in/4-in high efficiency) pleated, permanent, throwaway media	122.22	32 - 25 x 20 4 - 25 x 16
Angled (2-in. or 4-in.) Pleated, permanent, throwaway media	194.44	56 - 25 x 20
Side load bag or cartridge	134.00	28 - 24 x 24 4 - 24 x 12 7 - 12 x 24
Front load bag or cartridge	126.00	7 - 12 x 24 8 - 24 x 24
Front load HEPA	119.00	7 - 30 x 24 7 - 30 x 24 7 - 30 x 24 7 - 12x24
TCAPS Module, Flat Side Load	134.00	11 - 12 x 24 28 - 24 x 24

Note: 2-inch filters available in permanent, throwaway, or pleated media; 4-inch filters available in pleated media, 65%, 85%, or 95% efficiency; Bag or cartridge filters available in 65%, 85%, or 95% efficiency.

Table 64. Coil availability — size 120

Section Type	1/2-in Unit Coils	5/8-in Unit Coils 1/2-in and 5/8-in Modified Coils
Small	—	—
Medium	2-4 rows	1-3 rows
Extended-medium	2-8 rows	1-6 rows
Medium-large	2-8 rows	1-10 rows
-with access	—	—
Large horizontal	—	—



General Data

Table 64. Coil availability — size 120 (continued)

Section Type	1/2-in Unit Coils	5/8-in Unit Coils 1/2-in and 5/8-in Modified Coils
-with access	—	—
Large vertical	—	—
-with access	—	—

Table 65. Coil data for unit size 120

Coil Type	Rows	Fin Type	Area ft ²	Qty – Size (in.)
1/2-inch unit coils				
-UA, UW, UF, UU, UP (stacked)	2, 4, 6, 8	Aluminum	118.13	1 - 57.50 x 168 1 - 43.75 x 168
5/8-inch unit coils				
-W, WD, 5D, 5W, D1, D2 (stacked)	1, 2, 3, 4, 6, 8	Aluminum or Copper	119.00	2 - 51 x 168
-W, WD, D1, D2 (stacked)	10	Aluminum	115.50	3 - 33 x 168
1-inch unit coil				
-NS (stacked)	1	Aluminum or Copper	96.00	2 - 33 x 144 1 - 30 x 144
1/2-inch modified coils				
-WL, LL, FD, WP (stacked)	2, 4, 6, 8	Aluminum	91.88	1 - 42.50 x 168 1 - 36.25 x 168
5/8-inch modified coils				
-W, WD, 5W, D1, D2 (stacked)	1, 2, 3, 4, 6, 8	Aluminum or Copper	91.00	1 - 42 x 168 1 - 36 x 168
-W, WD, D1, D2 (stacked)	10	Aluminum	91.00	1 - 30 x 168 2 - 24 x 168
1-inch modified coil				
-NS (stacked)	1	Aluminum or Copper	78.00	1 - 30 x 144 2 - 24 x 144



Coils

Coil Depth

Table 66. Coil depth by rows (inches)

Tube Diameter	Unit Size	Coil Rows						
		1	2	3	4	6	8	10
1/2-inch (unit height)	3-40	—	6.55	—	6.55	8.72	10.88	—
1/2-inch (unit height)	50-120	—	5.72	—	7.88	10.05	12.21	—
1/2-inch (modified height) ^(a)	All sizes	—	6.50	—	9/50	12.50	15.50	—
3/8-inch (hydronic)	3-30	3.92	6.32	—	6.32	7.80	9.53	—
3/8-inch (dx)	3-30	—	—	—	6.32	7.80	9.53	—
5/8-inch	All sizes	4.00	6.50	8.00	9.50	12.50	15.50	18.50
1-inch	All sizes	5.25	—	—	—	—	—	—

Note: Unit coils include UF, UW, UP, UU. Example: Size 30 with a 4-row UW coil in an extended-medium coil section, there would be 10.82-inches of drain pan exposed beyond the coil casing for cleaning access.

^(a) Modified coils include WL, WP, LL, FD.

Coil Connections

Hydronic and Steam Coil Connections

Table 67. Water coils with 3/8-inch tubes connection diameter

Coil Type	Rows	Unit Size	Connection Diameter (inches)		
			Supply	Return	Drain/Vent
3W	1	3, 4	1.25	1.25	0.38
	1	6 - 30	1.50	1.50	0.38
	2	3 - 6	1.50	1.50	0.38
	2	8 - 17	2.00	2.00	0.38
	2	21 - 30	2.50	2.50	0.38
	4, 6, 8	3 - 6	1.50	1.50	0.38
3U	6	8, 10	2.00	2.00	0.38
	6	12-30	2.50	2.50	0.38
	4, 8	8 - 30	2.50	2.50	0.38

Table 68. Water coils with 1/2-inch tubes connection diameter

Coil Type	Rows	Unit Sizes	Quantity	Connection Diameter (inches)		
				Supply	Return	Drain/Vent
UW	2, 4, 6, 8	3-6	1	1.50	1.50	0.38
		8-14, 50-66	1	2.00	2.00	0.38
		17-40, 80-120	1	2.50	2.50	0.38
UA	2	3-14, 50-57	1	1.50	1.50	0.38
		17-40, 66-120	1	2.00	2.00	0.38



Coils

Table 68. Water coils with 1/2-inch tubes connection diameter (continued)

Coil Type	Rows	Unit Sizes	Quantity	Connection Diameter (inches)		
				Supply	Return	Drain/Vent
UU	4, 6, 8	12-120	1	2.50	2.50	0.38
UP	2, 4, 6, 8	3-14, 50-66	1	1.50	1.50	0.38
		17-40, 80-120	1	2.00	2.00	0.38
LL	4, 6, 8	8-120	1	2.50	2.50	0.38
WL	2, 4, 6, 8	3-10	1	1.50	1.50	0.38
		12-21, 66	1	2.00	2.00	0.38
		25-57, 80-120	1	2.50	2.50	0.38
WP	2, 4, 6, 8	3-40, 66-120	1	1.50	1.50	0.38
		50-57, 100-120	1	2.00	2.00	0.38

Note: All connections have external threads.

Table 69. Water coils with 5/8-inch tubes connection diameter

Coil Type	Rows	Header Height (in.)	Connection Diameter (inches)		
			Supply	Return	Drain/Vent
5A	2	12-27	2.00	2.00	0.38
		30-54	2.50	2.50	0.38
5D	6, 8, 10	45-55	2.50	2.50	0.38
5W	1	12-18	1.25	1.25	0.38
		24-54	1.50	1.50	0.38
5W	2	12-27	2.00	2.00	0.38
		30-54	2.50	2.50	0.38
D1	3, 4, 6, 8, 10	12-27	2.00	2.00	0.38
		30-55	2.50	2.50	0.38
D2	6, 8, 10	18-55	2.50	2.50	0.38
TT	1, 2	12-33	0.75	0.75	—
W	3, 4, 6, 8, 10	12-27	2.00	2.00	0.38
		24, 30-51	2.50	2.50	0.38
WD	6, 8, 10	18-55	2.50	2.50	0.38

Note: 5W, W (4-10 row), D1, D2, WD, and 5D connections have external threads and TT connections have internal threads.

Table 70. Steam coils with 1-inch tubes connection diameter

Coil Type	Rows	Header Height (in.)	Connection Diameter (inches)		
			Supply	Return	Drain/Vent
NS	1	12	1.50	1.00	1.00
		18	2.00	1.00	1.00
		24	2.50	1.25	1.25
		30-33	3.00	1.25	1.25

Note: All connections have internal threads.

Refrigerant Coil Connections

Table 71. Type 3F refrigerant coil connection sizes for unit sizes 3 to 30

Unit size	Header Height (in.)	Rows	Dist Tube	No. of Circuits	Circuiting		Connection Diameter (inches)							
							1 Distributor		2 Distributor		3 Distributor		4 Distributor	
							Liquid	Suction	Liquid	Suction	Liquid	Suction	Liquid	Suction
3,4	20	4,6,8	0.19	19	Full	Sing, Int, Horz	1.13	1.38	1.13	1.38	—	—	—	—
		4,6	0.19	9	Half	Sing	1.13	1.38	—	—	—	—	—	—
						Int	1.13	0.88	1.13	0.88	—	—	—	—
		8	0.19	9	Half	Int	1.38	1.13	1.38	1.13	—	—	—	—
4	0.19	4	Qtr	Sing	0.63	1.13	—	—	—	—	—	—	—	
6	26	4,6	0.19	25	Full	Int, Horz	1.13	1.38	1.13	1.38	—	—	—	—
		4	0.19	12	Half	Sing	0.88	1.13	—	—	—	—	—	—
		6	0.19	12	Half	Sing	1.13	1.38	—	—	—	—	—	—
						Int	0.88	1.13	0.88	1.13	—	—	—	—
		4	0.19	6	Qtr	Sing	0.88	1.13	—	—	—	—	—	—
						Int	0.63	1.13	0.63	1.13	—	—	—	—
8,10	28	4,6,8	0.19	27	Full	Int, Horz	1.13	1.63	1.13	1.63	—	—	—	—
		4,6	0.19	13	Half	Sing	1.13	1.63	—	—	—	—	—	—
						Int	0.88	1.13	0.88	1.13	—	—	—	—
		4	0.19	6	Qtr	Sing	0.88	1.13	—	—	—	—	—	—
Int	0.63					1.13	0.63	1.13	—	—	—	—		
12,14	32	4,6,8	0.19	31	Full	Int, Horz	1.13	1.63	1.13	1.63	—	—	—	—
		4,6	0.19	15	Half	Sing	1.13	1.63	—	—	—	—	—	—
						Int	1.13	1.13	1.13	1.13	—	—	—	—
		4	0.19	6	Qtr	Sing	0.88	1.13	—	—	—	—	—	—
						Int	0.63	1.13	0.63	1.13	—	—	—	—
17	40	4,6,8	0.19	39	Full	Int	1.125	1.375	1.125	1.375	1.125	1.375	1.125	1.375
						Horz	1.13	1.38	1.13	1.38	1.13	1.38	1.13	1.38
		4,6	0.19	19	Half	Int	0.88	1.13	0.88	1.13	0.88	1.13	0.88	1.13
						Horz	1.13	1.38	1.13	1.38	—	—	—	—
21	43	4,6,8	0.19	42	Full	Int, Horz	1.13	1.38	1.13	1.38	1.13	1.38	1.13	1.38
		4,6	0.19	21	Half	Int	0.88	1.13	0.88	1.13	0.88	1.13	0.88	1.13
						Hor	1.13	1.38	1.13	1.38	—	—	—	—
25,30	52	4,6,8	0.19	51	Full	Int, Horz	1.13	1.63	1.13	1.63	1.13	1.63	1.13	1.63
		4,6	0.19	25	Half	Int	0.88	1.13	0.88	1.13	0.88	1.13	0.88	1.13
						Horz	1.13	1.63	1.125	1.63	—	—	—	—



Coils

Table 72. Type UF refrigerant coil connection sizes for unit sizes 3 to 120

Unit Size	Header Height (in.)	Rows	Dist Tube	No. of Circuits	Circuiting	Connection Diameter (inches)					
						1 Distributor		2 Distributor		4 Distributor	
						Liquid	Suction	Liquid	Suction	Liquid	Suction
3, 4	20	4, 6, 8	0.25	15	Full	—	—	1.13	Note ¹	—	—
			0.19	15	Full	—	—	Note ²	Note ¹	—	—
		4, 6	0.25	7	Half	1.13	1.38	0.88	1.38	—	—
			0.19	7	Half	0.88	1.38	0.63	1.38	—	—
		4	0.25	3	Quarter	0.88	1.38	—	—	—	—
			0.19	3	Quarter	0.63	1.38	—	—	—	—
6	26	4, 6, 8	0.25	20	Full	—	—	1.13	1.63	—	—
			0.19	20	Full	—	—	1.13	1.63	—	—
		4, 6	0.25	10	Half	1.13	1.63	0.88	1.38	—	—
			0.19	10	Half	1.13	1.63	0.88	1.38	—	—
		4	0.25	5	Quarter	0.88	1.38	0.88	1.38	—	—
			0.19	5	Quarter	0.88	1.38	0.63	1.38	—	—
8, 10	28	4, 6, 8	0.25	22	Full	—	—	1.38	1.63	—	—
			0.19	22	Full	—	—	1.13	1.63	—	—
		4, 6	0.25	11	Half	1.38	1.63	0.88	1.38	—	—
			0.19	11	Half	1.13	1.63	0.88	1.38	—	—
		4	0.25	4	Quarter	0.88	1.38	0.88	1.38	—	—
			0.19	4	Quarter	0.63	1.38	0.63	1.38	—	—
12, 14	32	4, 6, 8	0.25	25	Full	—	—	1.38	1.63	—	—
			0.19	25	Full	—	—	1.13	1.63	—	—
		4, 6	0.25	12	Half	1.38	1.63	1.13	1.38	—	—
			0.19	12	Half	1.13	1.63	0.88	1.38	—	—
		4	0.25	6	Quarter	1.13	1.38	0.88	1.38	—	—
			0.19	6	Quarter	0.88	1.38	0.63	1.38	—	—
17	40	4, 6, 8	0.25	31	Full	—	—	—	—	1.13	Note ⁵
			0.19	31	Full	—	—	—	—	Note ⁴	Note ⁵
		4, 6	0.25	15	Half	—	—	1.13	Note ⁷	0.88	1.38
			0.19	15	Half	—	—	Note ⁶	Note ⁷	0.63	1.38
21	43	4, 6, 8	0.25	34	Full	—	—	—	—	1.13	1.63
			0.19	34	Full	—	—	—	—	1.13	1.63
		4, 6	0.25	17	Half	—	—	1.13	1.63	0.88	1.38
			0.19	17	Half	—	—	1.13	1.63	Note ⁸	1.38
25, 30	52	4, 6, 8	0.25	41	Full	—	—	—	—	1.38	1.63
			0.19	41	Full	—	—	—	—	1.13	1.63
		4, 6	0.25	20	Half	—	—	1.13	1.63	0.88	1.38
			0.19	20	Half	—	—	1.13	1.63	0.88	1.38

Table 72. Type UF refrigerant coil connection sizes for unit sizes 3 to 120 (continued)

Unit Size	Header Height (in.)	Rows	Dist Tube	No. of Circuits	Circuiting	Connection Diameter (inches)					
						1 Distributor		2 Distributor		4 Distributor	
						Liquid	Suction	Liquid	Suction	Liquid	Suction
35, 40	57	4, 6, 8	0.25	45	Full	—	—	—	—	1.38	1.63
			0.19	45	Full	—	—	—	—	1.13	1.63
		4, 6	0.25	22	Half	—	—	1.38	1.63	1.38	1.63
			0.19	22	Half	—	—	1.13	1.63	Note ⁹	Note ¹⁰
50	31	4, 6, 8	0.25	24	Full	—	—	1.38	1.63	—	—
			0.19	24	Full	—	—	1.13	1.63	—	—
		4, 6	0.25	12	Half	1.38	1.63	1.13	1.38	—	—
			0.19	12	Half	1.13	1.63	0.88	1.38	—	—
		4	0.25	6	Quarter	1.13	1.38	0.88	1.38	—	—
			0.19	6	Quarter	0.88	1.38	0.63	1.38	—	—
57	36	4, 6, 8	0.25	28	Full	—	—	—	—	1.13	1.38
			0.19	28	Full	—	—	—	—	0.88	1.38
		4, 6	0.25	14	Half	—	—	1.13	1.38	—	—
			0.19	14	Half	—	—	0.88	1.38	—	—
66	37	4, 6, 8	0.25	29	Full	—	—	—	—	1.13	Note ¹¹
			0.19	29	Full	—	—	—	—	Note ¹²	Note ¹¹
		4, 6	0.25	14	Half	—	—	1.13	1.38	—	—
			0.19	14	Half	—	—	0.88	1.38	—	—
80	45	4, 6, 8	0.25	35	Full	—	—	—	—	1.13	1.63
			0.19	35	Full	—	—	—	—	1.13	1.63
		4, 6	0.25	17	Half	—	—	1.13	1.63	0.88	1.38
			0.19	17	Half	—	—	1.13	1.63	Note ¹³	1.38
100, 120	51	4, 6, 8	0.25	40	Full	—	—	—	—	1.13	1.63
			0.19	40	Full	—	—	—	—	1.13	1.63
		4, 6	0.25	20	Half	—	—	1.13	1.63	0.88	1.38
			0.19	20	Half	—	—	1.13	1.63	0.88	1.38

Notes:

1. Bottom suction connection is 1.63-inches and top suction connection is 1.38-inch.
2. Bottom liquid connection is 1.13-inches and top liquid connection is 0.88-inch.
3. Connections are 1.13 for intertwined and 1.38-inches for horizontal split.
4. Three connections are 1.13-inches and one is 0.88-inch.
5. Three connections are 1.63-inches and one is 1.38-inches.
6. One connection is 0.88-inch and one is 1.13-inches.
7. One connection is 1.38-inches and one is 1.63-inches.
8. Three connection are 0.63-inch and one is 0.88-inch.
9. Liquid connections are 0.88-inch for intertwined and 1.13-inches for horizontal split.
10. Suction connections are 1.38-inches for intertwined and 1.63-inches for horizontal split.
11. Three suction connections are 1.38-inches and one is 1.63-inches.
12. Three liquid connections are 0.88-inches and one is 1.13-inches.
13. Three connections are 0.63-inches and one connection is 0.88-inches.



Coils

Table 73. Type FD refrigerant coil connection sizes for unit sizes 3 to 120

Unit Size	Header Height (in.)	Rows	Dist Tube	No. of Circuits	Circuiting	Connection Diameter (inches)					
						1 Distributor		2 Distributor		4 Distributor	
						Liquid	Suction	Liquid	Suction	Liquid	Suction
8, 10	18	4, 6	0.25	14	Full	—	—	1.13	1.38	—	—
			0.19	14	Full	—	—	0.88	1.38	—	—
		4, 6	0.25	7	Half	1.13	1.38	0.88	1.38	—	—
			0.19	7	Half	0.88	1.38	0.63	1.38	—	—
		4	0.25	4	Quarter	0.88	1.38	0.88	1.38	—	—
			0.19	4	Quarter	0.63	1.38	0.63	1.38	—	—
12, 14	24	4, 6	0.25	19	Full	—	—	1.13	1.63	—	—
			0.19	19	Full	—	—	1.13	1.63	—	—
		4, 6	0.25	9	Half	1.13	1.63	0.88	1.63	—	—
			0.19	9	Half	1.13	1.63	See Note (a)	1.63	—	—
		4	0.25	4	Quarter	0.88	1.38	0.88	1.38	—	—
			0.19	4	Quarter	0.63	1.38	0.63	1.38	—	—
17	30	4, 6	0.25	24	Full	—	—	1.38	1.63	—	—
			0.19	24	Full	—	—	1.13	1.63	—	—
		4, 6	0.25	12	Half	1.38	1.63	1.13	1.63	—	—
			0.19	12	Half	1.13	1.63	0.88	1.63	—	—
		4	0.25	6	Quarter	1.13	1.63	0.88	1.63	—	—
			0.19	6	Quarter	0.88	1.63	0.63	1.63	—	—
21	33	4, 6	0.25	26	Full	—	—	1.38	1.63	—	—
			0.19	26	Full	—	—	1.13	1.63	—	—
		4, 6	0.25	13	Half	1.38	1.63	1.13	1.63	—	—
			0.19	13	Half	1.13	1.63	0.88	1.63	—	—
		4	0.25	6	Quarter	1.13	1.63	0.88	1.63	—	—
			0.19	6	Quarter	0.88	1.63	0.63	1.63	—	—
25, 30, 35, 40	36	4, 6	0.25	28	Full	—	—	—	—	1.13	1.38
			0.19	28	Full	—	—	—	—	0.88	1.38
50	42	4, 6	0.25	33	Full	—	—	—	—	1.13	1.63
			0.19	33	Full	—	—	—	—	1.13	1.63

Table 73. Type FD refrigerant coil connection sizes for unit sizes 3 to 120 (continued)

Unit Size	Header Height (in.)	Rows	Dist Tube	No. of Circuits	Circuiting	Connection Diameter (inches)					
						1 Distributor		2 Distributor		4 Distributor	
						Liquid	Suction	Liquid	Suction	Liquid	Suction
57	24	4, 6	0.25	19	Full	—	—	1.13	1.63	—	—
			0.19	19	Full	—	—	1.13	1.63	—	—
	24	4, 6	0.25	9	Half	1.13	1.63	0.88	1.63	—	—
			0.19	9	Half	1.13	1.63	See Note ^(b)	1.63	—	—
	24	4	0.25	4	Quarter	0.88	1.38	0.88	1.38	—	—
			0.19	4	Quarter	0.63	1.38	0.63	1.38	—	—
	30	4, 6	0.25	24	Full	—	—	1.38	1.63	—	—
			0.19	24	Full	—	—	1.13	1.63	—	—
	30	4, 6	0.25	12	Half	1.38	1.63	1.13	1.63	—	—
			0.19	12	Half	1.13	1.63	0.88	1.63	—	—
	30	4	0.25	6	Quarter	1.13	1.63	0.88	1.63	—	—
			0.19	6	Quarter	0.88	1.63	0.63	1.63	—	—
66	24	4, 6	0.25	19	Full	—	—	1.13	1.63	—	—
			0.19	19	Full	—	—	1.13	1.63	—	—
	24	4, 6	0.25	9	Half	1.13	1.63	0.88	1.63	—	—
			0.19	9	Half	1.13	1.63	See Note ^(b)	1.63	—	—
	24	4	0.25	4	Quarter	0.88	1.38	0.88	1.38	—	—
			0.19	4	Quarter	0.63	1.38	0.63	1.38	—	—
	33	4, 6	0.25	26	Full	—	—	1.38	1.63	—	—
			0.19	26	Full	—	—	1.13	1.63	—	—
	33	4, 6	0.25	13	Half	1.38	1.63	1.13	1.63	—	—
			0.19	13	Half	1.13	1.63	0.88	1.63	—	—
	33	4	0.25	6	Quarter	1.13	1.63	0.88	1.63	—	—
			0.19	6	Quarter	0.88	1.63	0.63	1.63	—	—
80	36	4, 6	0.25	28	Full	—	—	—	—	1.13	1.38
			0.19	28	Full	—	—	—	—	0.88	1.38
100	36	4, 6	0.25	28	Full	—	—	—	—	1.13	1.38
			0.19	28	Full	—	—	—	—	0.88	1.38
	42	4, 6	0.25	33	Full	—	—	—	—	1.13	1.63
			0.19	33	Full	—	—	—	—	1.13	1.63
120	36	4, 6	0.25	28	Full	—	—	—	—	1.13	1.38
			0.19	28	Full	—	—	—	—	0.88	1.38
	42	4, 6	0.25	33	Full	—	—	—	—	1.13	1.63
			0.19	33	Full	—	—	—	—	1.13	1.63

^(a) On a 4 row intertwined the liquid connection is 0.88-inch downstream and 0.63-inch upstream. On a 6 row intertwined the liquid connection is 0.64-inch downstream and 0.88 upstream.

^(b) For 4-row intertwined, the upstream liquid connection is 0.63-inches and the downstream liquid connection is 0.88-inches. For 6-row intertwined, the upstream liquid connection is 0.88-inches and the downstream liquid connection is 0.63-inches.



Coil Circuiting

Refrigerant coil circuiting is first defined by how the distributors are arranged on the coil and then by the number of tubes on the coil being fed refrigerant.

Distributor Arrangement

The term *standard circuiting* means the number of distributors used on a coil is the minimum required to meet capacity. If more than one distributor is required, then the coil is horizontally split so sections of the coil can be de-energized to unload the coil.

The term *horizontally split* circuiting means that at a minimum, each coil (or each coil in a bank) will have two or more distributors per coil. As each coil is horizontally split, sections of the coil can be de-energized to unload the coil.

The term *intertwined circuiting* means that at a minimum each coil (or each coil in a bank) will have two or more distributors per coil. Since each distributor is circuited from the top to the bottom of the coil, the full face of the coil remains energized even if a circuit is de-energized to unload the coil. If four distributors are used on a coil, then the coil is first horizontally split, with the top half of the coil intertwined using two distributors, and the bottom half of the coil intertwined using the other two distributors.

Distributor Circuiting

The terms *full*, *half*, and *quarter* see the number of coil tubes being fed refrigerant by each distributor of that coil. For example, full means that each tube in one row of the coil is being fed refrigerant from the distributor(s), while half means every other tube in a row is being fed.

Circuiting Example: See [Table 75, p. 83](#) table in Coils chapter lists standard distributor arrangements (minimum number or distributors) for UF coils. On a size 12 unit, 6-row coil with half circuiting (every other tube in a row being fed), there is one distributor, with 12 tubes in one row of the coil being fed refrigerant. Circuiting data is show by unit size and coil rows.

Table 74. Type 3F coil standard circuiting

Unit Size	Header Height (inches)	Coil Rows	Full		Half		Quarter	
			Dist Qty	Circuits per Dist	Dist Qty	Circuits per Dist	Dist Qty	Circuits per Dist
3, 4	20	4	2	9,10	1	9	1	4
		6	2	9,10	1	9	—	—
		8	2	9,10	—	—	—	—
6	26	4	2	12,13	1	12	1	6
		6	2	12,13	1	12	—	—
		8	2	12,13	—	—	—	—
8, 10	28	4	2	14,13	1	13	1	6
		6	2	14,13	1	13	—	—
		8	2	14,13	—	—	—	—
12, 14	32	4	2	15,16	1	15	1	6
		6	2	15,16	1	15	—	—
		8	2	15,16	—	—	—	—
17	40	4	4	9,10,10,10	2	9,10	—	—
		6	4	9,10,10,10	2	9,10	—	—
		8	4	9,10,10,10	—	—	—	—
21	43	4	4	10,10,11,11	2	10,11	—	—
		6	4	10,10,11,11	2	10,11	—	—
		8	4	10,10,11,11	—	—	—	—

Table 74. Type 3F coil standard circuiting (continued)

Unit Size	Header Height (inches)	Coil Rows	Full		Half		Quarter	
			Dist Qty	Circuits per Dist	Dist Qty	Circuits per Dist	Dist Qty	Circuits per Dist
25, 30	52	4	4	12,13,13,13	2	12,13	—	—
		6	4	12,13,13,13	2	12,13	—	—
		8	4	12,13,13,13	—	—	—	—

Table 75. Type UF coil standard circuiting

Unit size	Header Height (inches)	Coil rows	Full		Half		Quarter	
			Dist Qty	Circuits per Dist	Dist Qty	Circuits per Dist	Dist Qty	Circuits per Dist
3,4	20	4	2	7,8	1	7	1	3
		6	2	7,8	1	7	—	—
		8	2	7,8	—	—	—	—
6	26	4	2	10,10	1	10	1	5
		6	2	10,10	1	10	—	—
		8	2	10,10	—	—	—	—
8,10	28	4	2	11,11	1	11	1	4
		6	2	11,11	1	11	—	—
		8	2	11,11	—	—	—	—
12,14	32	4	2	12,13	1	12	1	6
		6	2	12,13	1	12	—	—
17	40	4	4	7,8,8,8	2	7,8	—	—
		6	4	7,8,8,8	2	7,8	—	—
		8	4	7,8,8,8	—	—	—	—
21	43	4	4	8,8,9,9	2	8,9	—	—
		6	4	8,8,9,9	2	8,9	—	—
		8	4	8,8,9,9	—	—	—	—
25, 30	52	4	4	10,10,10,11	2	10,10	—	—
		6	4	10,10,10,11	2	10,10	—	—
		8	4	10,10,10,11	—	—	—	—
35, 40	57	4	4	11,11,11,12	2	11,11	—	—
		6	4	11,11,11,12	2	11,11	—	—
		8	4	11,11,11,12	—	—	—	—
50 (Stacked)	31	4	2	12,12	1	12	1	6
		6	2	12,12	1	12	—	—
		8	2	12,12	—	—	—	—
	31	4	2	12,12	1	12	1	6
		6	2	12,12	1	12	—	—
		8	2	12,12	—	—	—	—



Coils

Table 75. Type UF coil standard circuiting (continued)

Unit size	Header Height (inches)	Coil rows	Full		Half		Quarter	
			Dist Qty	Circuits per Dist	Dist Qty	Circuits per Dist	Dist Qty	Circuits per Dist
57 (Stacked)	36	4	4	7,7,7,7	2	7,7	—	—
		6	4	7,7,7,7	2	7,7	—	—
		8	4	7,7,7,7	—	—	—	—
	36	4	4	7,7,7,7	2	7,7	—	—
		6	4	7,7,7,7	2	7,7	—	—
		8	4	7,7,7,7	—	—	—	—
66 (Stacked)	37	4	4	7,7,7,8	2	7,7	—	—
		6	4	7,7,7,8	2	7,7	—	—
		8	4	7,7,7,8	—	—	—	—
	37	4	4	7,7,7,8	2	7,7	—	—
		6	4	7,7,7,8	2	7,7	—	—
		8	4	7,7,7,8	—	—	—	—
80 (Stacked)	45	4	4	8,9,9,9	2	8,9	—	—
		6	4	8,9,9,9	2	8,9	—	—
		8	4	8,9,9,9	—	—	—	—
	45	4	4	8,9,9,9	2	8,9	—	—
		6	4	8,9,9,9	2	8,9	—	—
		8	4	8,9,9,9	—	—	—	—
100, 120 (Stacked)	51	4	4	10,10,10,10	2	10,10	—	—
		6	4	10,10,10,10	2	10,10	—	—
		8	4	10,10,10,10	—	—	—	—
	51	4	4	10,10,10,10	2	10,10	—	—
		6	4	10,10,10,10	2	10,10	—	—
		8	4	10,10,10,10	—	—	—	—

Table 76. Type UF coil intertwined circuiting

Unit Size	Header Height (inches)	Coil Rows	Full		Half		Quarter	
			Dist Qty	Circuits per Dist	Dist Qty	Circuits per Dist	Dist Qty	Circuits per Dist
3, 4	20	4, 6	2	7, 8	2	3, 4	—	—
		8	2	7, 8	—	—	—	—
6	26	4	2	10, 10	2	5, 5	2	2, 3
		6	2	10, 10	2	5, 5	—	—
		8	2	10, 10	—	—	—	—
8, 10	28	4	2	11, 11	2	5, 6	2	2, 2
		6	2	11, 11	2	5, 6	—	—
		8	2	11, 11	—	—	—	—

Table 76. Type UF coil intertwined circuiting (continued)

Unit Size	Header Height (inches)	Coil Rows	Full		Half		Quarter	
			Dist Qty	Circuits per Dist	Dist Qty	Circuits per Dist	Dist Qty	Circuits per Dist
12, 14	32	4	2	12, 13	2	6, 6	2	3, 3
		6	2	12, 13	2	6, 6	—	—
		8	2	12, 13	—	—	—	—
17	40	4, 6	4	8, 7, 8, 8	4	4, 3, 4, 4	—	—
		8	4	8, 7, 8, 8	—	—	—	—
21	43	4, 6	4	8, 8, 9, 9	4	4, 4, 4, 5	—	—
		8	4	8, 8, 9, 9	—	—	—	—
25, 30	52	4, 6	4	10, 10, 10, 11	4	5, 5, 5, 5	—	—
		8	4	10, 10, 10, 11	—	—	—	—
35, 40	57	4, 6	4	11, 11, 11, 12	4	5, 6, 5, 6	—	—
		8	4	11, 11, 11, 12	—	—	—	—
50 (Stacked)	31	4	2	12, 12	2	6, 6	2	3, 3
		6	2	12, 12	2	6, 6	—	—
		8	2	12, 12	—	—	—	—
	31	4	2	12, 12	2	6, 6	2	3, 3
		6	2	12, 12	2	6, 6	—	—
		8	2	12, 12	—	—	—	—
57 (Stacked)	36	4	4	7, 7, 7, 7	2	7, 7	—	—
		6	4	7, 7, 7, 7	2	7, 7	—	—
		8	4	7, 7, 7, 7	—	—	—	—
	36	4	4	7, 7, 7, 7	2	7, 7	—	—
		6	4	7, 7, 7, 7	2	7, 7	—	—
		8	4	7, 7, 7, 7	—	—	—	—
66 (Stacked)	37	4	4	7, 7, 7, 8	2	7, 7	—	—
		6	4	7, 7, 7, 8	2	7, 7	—	—
		8	4	7, 7, 7, 8	—	—	—	—
	37	4	4	7, 7, 7, 8	2	7, 7	—	—
		6	4	7, 7, 7, 8	2	7, 7	—	—
		8	4	7, 7, 7, 8	—	—	—	—
80 (Stacked)	45	4	4	8, 9, 9, 9	4	4, 4, 4, 5	—	—
		6	4	8, 9, 9, 9	4	4, 4, 4, 5	—	—
		8	4	8, 9, 9, 9	—	—	—	—
	45	4	4	8, 9, 9, 9	4	4, 4, 4, 5	—	—
		6	4	8, 9, 9, 9	4	4, 4, 4, 5	—	—
		8	4	8, 9, 9, 9	—	—	—	—



Coils

Table 76. Type UF coil intertwined circuiting (continued)

Unit Size	Header Height (inches)	Coil Rows	Full		Half		Quarter	
			Dist Qty	Circuits per Dist	Dist Qty	Circuits per Dist	Dist Qty	Circuits per Dist
100, 120 (Stacked)	51	4	4	10,10,10,10	4	5,5,5,5	—	—
		6	4	10,10,10,10	4	5,5,5,5	—	—
		8	4	10,10,10,10	—	—	—	—
	51	4	4	10,10,10,10	4	5,5,5,5	—	—
		6	4	10,10,10,10	4	5,5,5,5	—	—
		8	4	10,10,10,10	—	—	—	—

Table 77. Type FD coil standard circuiting

Unit Size	Header Height (inches)	Coil Rows	Full		Half		Quarter	
			Dist Qty	Circuits per Dist	Dist Qty	Circuits per Dist	Dist Qty	Circuits per Dist
8,10	18	4	2	7,7	1	7	1	4
		6	2	7,7	1	7	—	—
12,14	24	4	2	9,10	1	9	1	4
		6	2	9,10	1	9	—	—
17	30	4	2	12,12	1	12	1	6
		6	2	12,12	1	12	—	—
21	33	4	2	13,13	1	13	1	6
		6	2	13,13	1	13	—	—
25, 30, 35, 40	36	4	4	7,7,7,7	—	—	—	—
		6	4	7,7,7,7	—	—	—	—
50	42	4	4	8,8,8,9	—	—	—	—
		6	4	8,8,8,9	—	—	—	—
57 (Stacked)	24	4	2	9,10	1	9	1	4
		6	2	9,10	1	9	—	—
	30	4	2	12,12	1	12	1	6
		6	2	12,12	1	12	—	—
66 (Stacked)	24	4	2	9,10	1	9	1	4
		6	2	9,10	1	9	—	—
	33	4	2	13,13	1	13	1	6
		6	2	13,13	1	13	—	—
80 (Stacked)	36	4	4	7,7,7,7	—	—	—	—
		6	4	7,7,7,7	—	—	—	—
	36	4	4	7,7,7,7	—	—	—	—
		6	4	7,7,7,7	—	—	—	—

Table 77. Type FD coil standard circuiting (continued)

Unit Size	Header Height (Inches)	Coil Rows	Full		Half		Quarter	
			Dist Qty	Circuits per Dist	Dist Qty	Circuits per Dist	Dist Qty	Circuits per Dist
100, 120 (Stacked)	36	4	4	7,7,7,7	—	—	—	—
		6	4	7,7,7,7	—	—	—	—
	42	4	4	8,8,8,9	—	—	—	—
		6	4	8,8,8,9	—	—	—	—

Table 78. Type FD coil intertwined circuiting

Unit Size	Header Height (Inches)	Coil Rows	Full		Half		Quarter	
			Dist Qty	Circuits per Dist	Dist Qty	Circuits per Dist	Dist Qty	Circuits per Dist
8, 10	18	4	2	7, 7	2	3, 4	2	2, 2
		6	2	7, 7	2	3, 4	—	—
12, 14	24	4	2	10, 9	2	4, 5	2	2, 2
		6	2	10, 9	2	4, 5	—	—
17	30	4	2	12, 12	2	6, 6	2	3, 3
		6	2	12, 12	2	6, 6	—	—
21	33	4	2	13, 13	2	6, 7	2	3, 3
		6	2	13, 13	2	6, 7	—	—
25, 30, 35, 40	36	4	4	7, 7, 7, 7	—	—	—	—
		6	4	7, 7, 7, 7	—	—	—	—
50	42	4	4	8, 9, 8, 8	—	—	—	—
		6	4	8, 9, 8, 8	—	—	—	—
57 (Stacked)	24	4	2	10, 9	2	4, 5	2	2, 2
		6	2	10, 9	2	4, 5	—	—
	30	4	2	12, 12	2	6, 6	2	3, 3
		6	2	12, 12	2	6, 6	—	—
66 (Stacked)	24	4	2	10, 9	2	4, 5	2	2, 2
		6	2	10, 9	2	4, 5	—	—
	33	4	2	13, 13	2	6, 7	2	3, 3
		6	2	13, 13	2	6, 7	—	—
80 (Stacked)	36	4	4	7, 7, 7, 7	—	—	—	—
		6	4	7, 7, 7, 7	—	—	—	—
	36	4	4	7, 7, 7, 7	—	—	—	—
		6	4	7, 7, 7, 7	—	—	—	—
100, 120 (Stacked)	36	4	4	7, 7, 7, 7	—	—	—	—
		6	4	7, 7, 7, 7	—	—	—	—
	42	4	4	8, 9, 8, 8	—	—	—	—
		6	4	8, 9, 8, 8	—	—	—	—

Face-Velocity Limits for Moisture Carryover

Cooling coils are available with a wide variety of fin types and materials, including the following, to help optimize their performance:

- 1/2-inch: Delta-Flo E and Delta-Flo H aluminum fins
- 5/8-inch: Prima-Flo E and Prima-Flo H aluminum and copper fins
- 3/8-inch: Omega-Flo H aluminum fins

All of these fins are available with variable fin spacing (that is, the spacing can increment by as little as one fin per foot). Also, Delta-Flo H and Prima-Flo H fins are specifically designed to help maximize heat transfer while minimizing moisture carryover.

Moisture carryover limits for each of these fin types is detailed in the following charts. Refer to Trane Select Assist selection program for availability.

Figure 54. Face-velocity limits for moisture carryover with uncoated coils in unit sizes 3-10

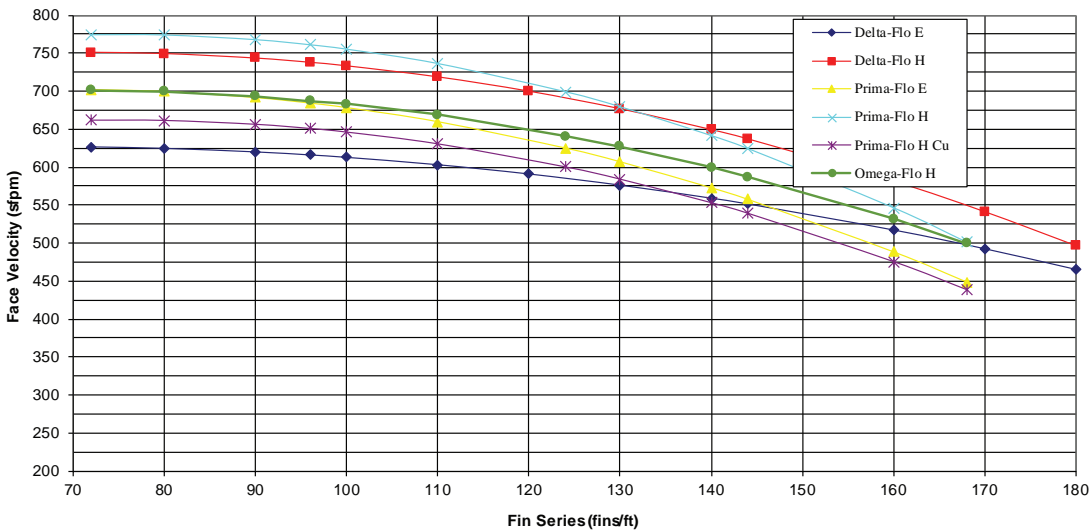

Figure 55. Face-velocity limits for moisture carryover with uncoated coils in unit size 12



Figure 56. Face-velocity limits for moisture carryover with uncoated coils in unit sizes 14-17

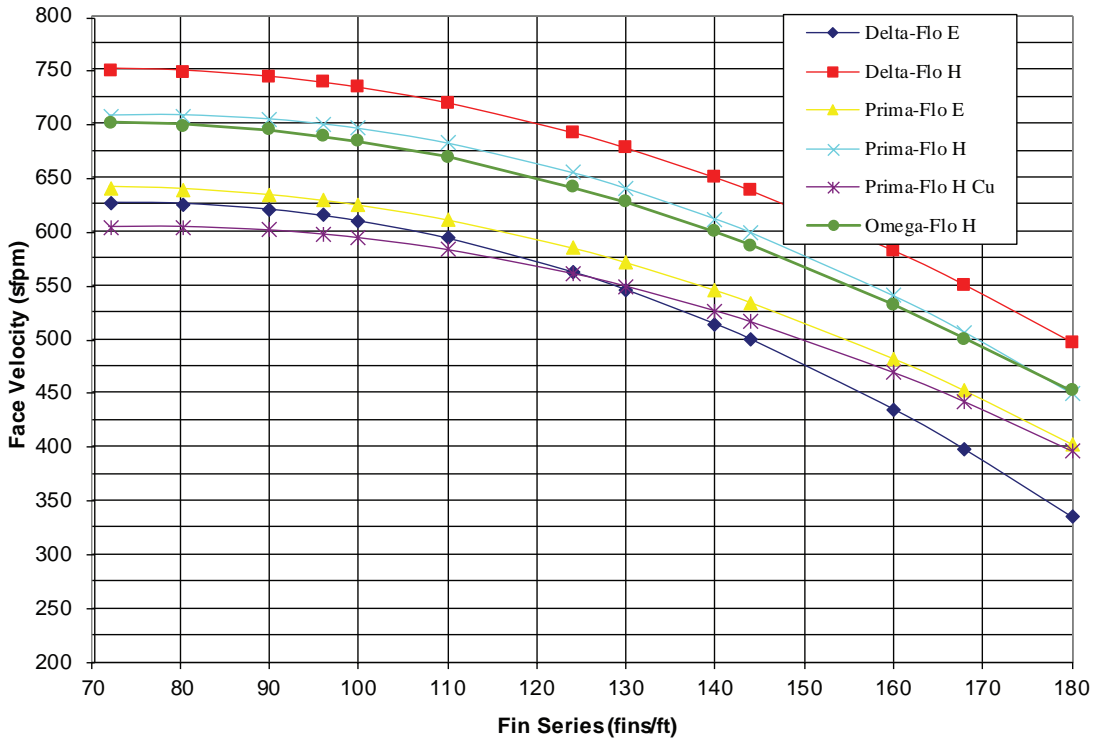

Figure 57. Face-velocity limits for moisture carryover with uncoated coils in unit sizes 21-30

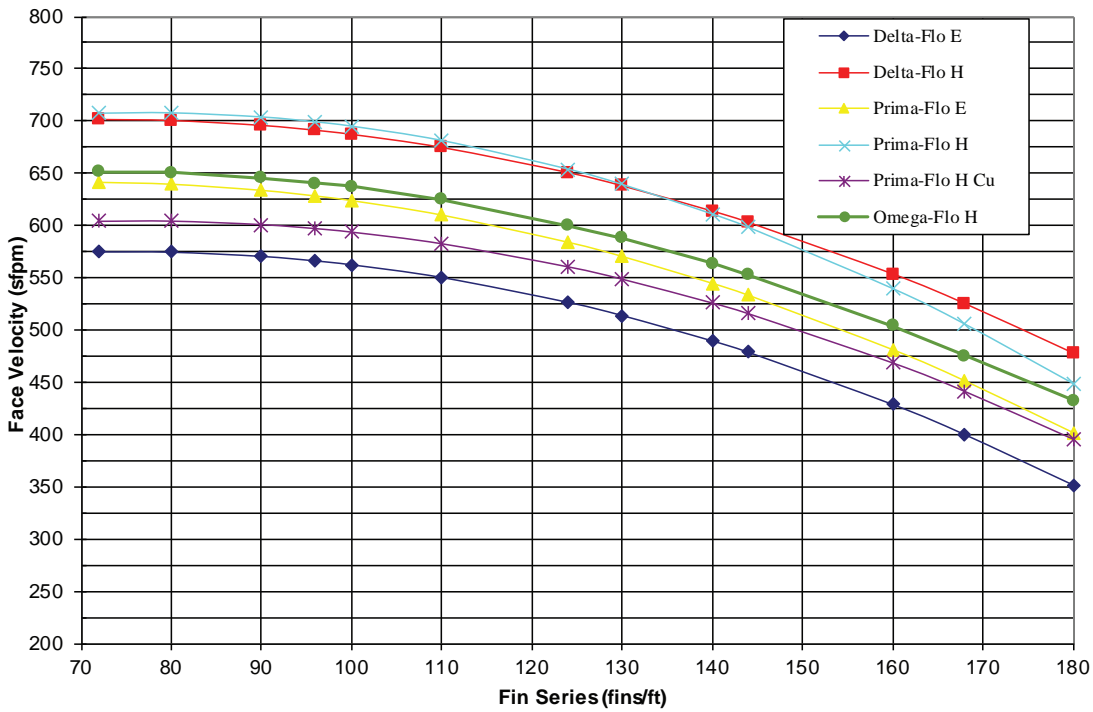

Figure 58. Face velocity limits for moisture carryover with uncoated coils in unit sizes 35-40

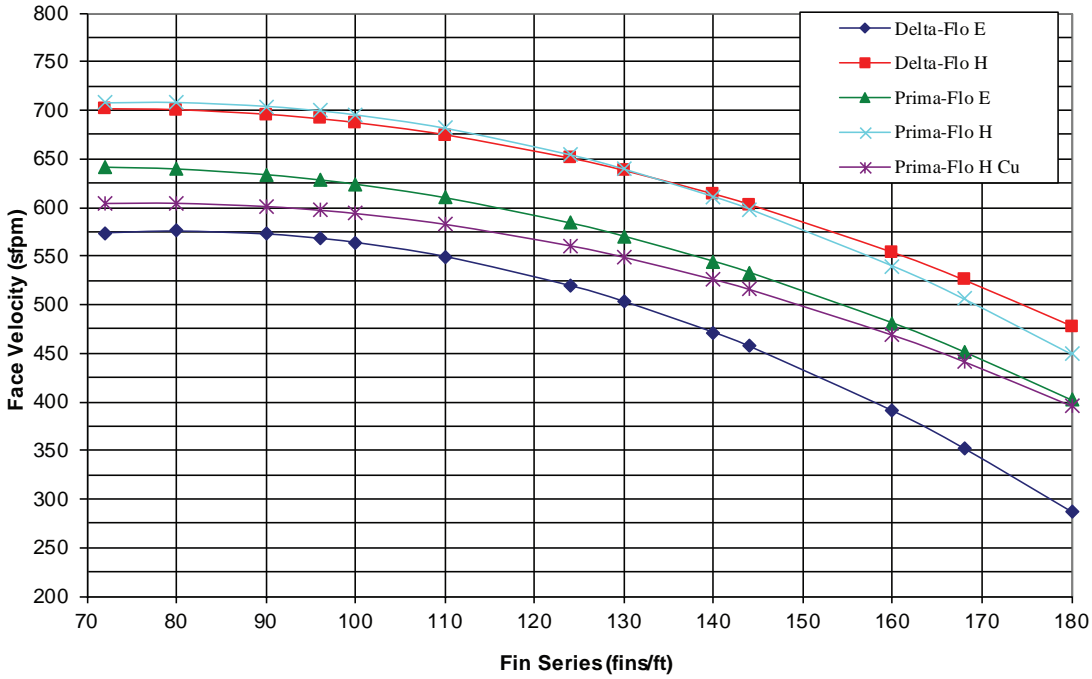

Figure 59. Face velocity limits for moisture carryover with uncoated coils in unit sizes 50-57

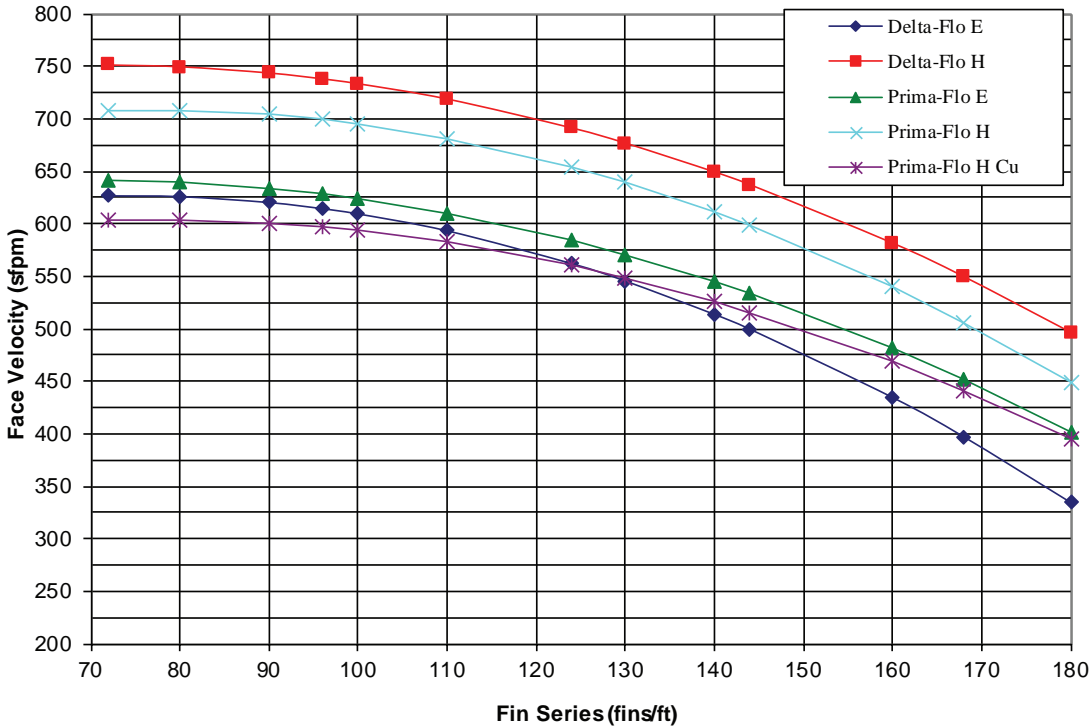

Figure 60. Face velocity limits for moisture carryover with uncoated coils in unit size 66

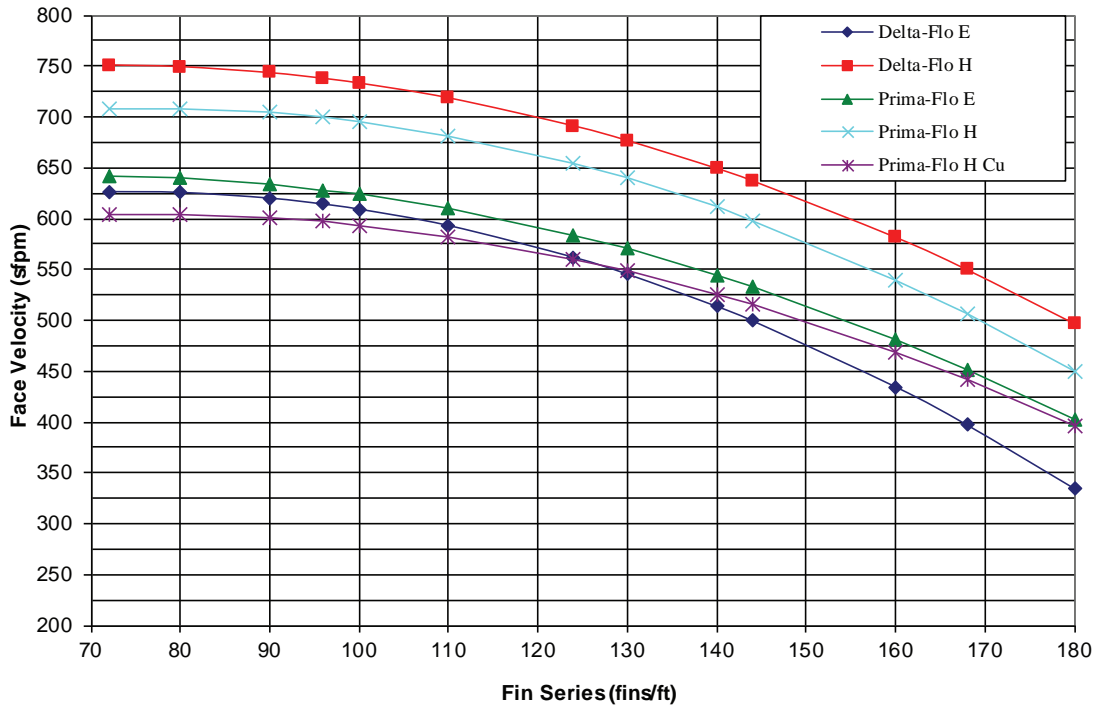
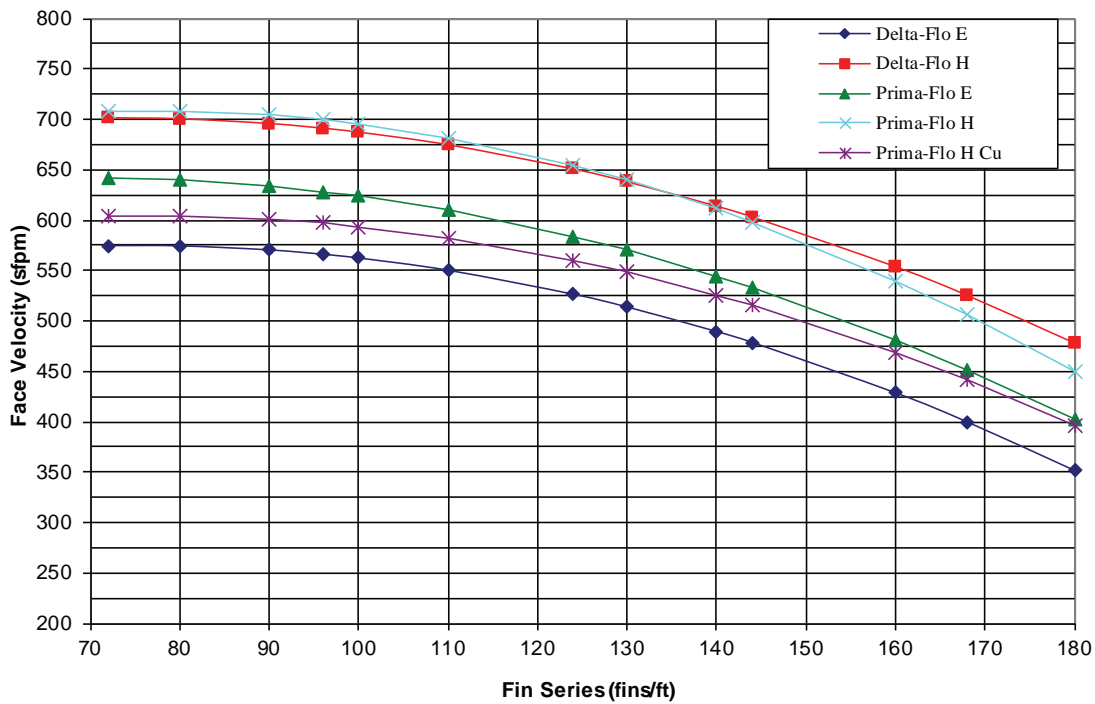

Figure 61. Face velocity limits for moisture carryover with uncoated coils in unit size 80-120





Performance Data

Air-to-Air Plate Frame Heat Exchangers

Table 79. Air-to-air plate frame heat exchanger performance data

Unit size	Nominal airflow ^(a) cfm	Plate spacing	Bypass exchanger		High efficiency exchanger		Low efficiency exchanger	
			% sensible effectiveness	Pressure drop (in w.g.)	% sensible effectiveness	Pressure drop (in w.g.)	% sensible effectiveness	Pressure drop (in w.g.)
3	1500	Wide	50	0.35	56	0.24	—	—
		Medium	58	0.59	60	0.32		
		Close	65	1.21	66	0.67		
4	2000	Wide	52	0.26	57	0.18	—	—
		Medium	59	0.40	60	0.25		
		Close	66	0.83	66	0.54		
6	3000	Wide	53	0.42	55	0.23	—	—
		Medium	60	0.58	65	0.43		
		Close	64	0.76	69	0.89		
8	4000	Wide	53	0.48	54	0.29	—	—
		Medium	60	0.66	64	0.54		
		Close	63	0.87	69	1.10		
10	5000	Wide	58	0.37	59	0.22	49	0.39
		Medium	61	0.52	62	0.33	54	0.52
		Close	66	0.87	67	0.56	58	0.66
12	6000	Wide	57	0.44	59	0.27	54	0.35
		Medium	61	0.62	62	0.39	61	0.49
		Close	66	1.01	67	0.66	64	0.64
14	7000	Wide	57	0.49	58	0.31	54	0.39
		Medium	60	0.69	62	0.44	60	0.55
		Close	66	1.12	67	0.74	64	0.72
17	8500	Wide	63	0.65	64	0.42	57	0.45
		Medium	67	0.87	68	0.56	61	0.63
		Close	69	1.13	70	0.75	66	1.03
21	10500	Wide	63	0.73	64	0.50	61	0.43
		Medium	64	0.86	68	0.66	64	0.53
		Close	67	0.97	70	0.88	68	0.73
25	12500	Wide	59	0.78	60	0.50	63	0.68
		Medium	66	0.84	67	0.54	65	0.81
		Close	69	0.99	70	0.63	67	0.91
30	15000	Wide	59	0.78	60	0.51	63	0.70
		Medium	66	0.84	67	0.55	65	0.82
		Close	69	0.98	70	0.65	67	0.93

Table 79. Air-to-air plate frame heat exchanger performance data (continued)

Unit size	Nominal airflow ^(a) cfm	Plate spacing	Bypass exchanger		High efficiency exchanger		Low efficiency exchanger	
			% sensible effectiveness	Pressure drop (in w.g.)	% sensible effectiveness	Pressure drop (in w.g.)	% sensible effectiveness	Pressure drop (in w.g.)
35	17500	Wide	59	0.87	60	0.59	—	—
		Medium	66	0.94	67	0.64		
		Close	69	1.09	69	0.75		
40	20000	Wide	59	0.87	60	0.60	—	—
		Medium	66	0.94	67	0.65		
		Close	69	1.10	69	0.76		
50	25000	Wide	—	—	—	—	59	0.72
		Medium					66	0.78
		Close					69	0.92

^(a) Stated performance is based on a dry exchanger with the exhaust and ventilation airflow rate equal to the nominal airflow. Performance will vary based on airflow conditions, utilize Trane Select Assist for application specific performance.

Table 80. Air-to-air plate frame heat exchanger bypass damper performance data

Unit size	Face Area (ft ²)	Static Pressure Drop (inches w.g.) by face velocity (fpm)									
		800	1000	1200	1400	1600	1800	2000	2200	2400	2600
3	1.17	0.23	0.36	0.52	0.71	0.93	1.18	—	—	—	—
4	1.34	0.23	0.36	0.52	0.71	0.93	1.18	—	—	—	—
6	2.07	0.17	0.26	0.38	0.52	0.67	0.85	1.05	1.27	—	—
8	2.07	0.17	0.26	0.38	0.52	0.67	0.85	1.05	1.27	—	—
10	2.96	0.15	0.23	0.33	0.45	0.59	0.75	0.92	1.12	1.33	—
12	3.21	0.14	0.22	0.32	0.44	0.57	0.72	0.89	1.08	1.28	—
14	3.45	0.14	0.22	0.31	0.42	0.55	0.70	0.86	1.05	1.25	—
17	4.43	0.13	0.21	0.30	0.41	0.53	0.67	0.83	1.00	1.19	—
21	4.43	0.13	0.21	0.30	0.41	0.53	0.67	0.83	1.00	1.19	—
25	6.34	0.12	0.19	0.28	0.38	0.49	0.62	0.77	0.93	1.11	1.30
30	7.14	0.12	0.19	0.27	0.36	0.47	0.60	0.74	0.90	1.07	1.25
35	7.14	0.12	0.19	0.27	0.36	0.47	0.60	0.74	0.90	1.07	1.25
40	7.93	0.12	0.18	0.26	0.35	0.46	0.58	0.72	0.87	1.04	1.22

Blenders

Table 81. Blender performance data

Unit size	Area (ft ²)	Static Pressure Drop (inches w.g.) by Plenum Face Velocity (fpm)									
		200	250	300	350	400	450	500	550	600	
3	1.90	0.03	0.04	0.06	0.08	0.10	0.13	0.16	0.20	0.24	
4	2.30	0.04	0.07	0.10	0.13	0.17	0.21	0.27	0.32	0.38	
6	3.30	0.03	0.05	0.07	0.10	0.13	0.16	0.20	0.24	0.28	
8	3.90	0.04	0.06	0.08	0.11	0.15	0.19	0.23	0.28	0.34	
10	4.50	0.04	0.07	0.10	0.14	0.18	0.23	0.28	0.34	0.40	



Performance Data

Table 81. Blender performance data (continued)

Unit size	Area (ft ²)	Static Pressure Drop (inches w.g.) by Plenum Face Velocity (fpm)								
		200	250	300	350	400	450	500	550	600
12	5.90	0.04	0.06	0.08	0.11	0.15	0.19	0.23	0.28	0.33
14	5.80	0.05	0.08	0.11	0.15	0.19	0.24	0.30	0.36	0.43
17	9.00	0.03	0.04	0.06	0.08	0.10	0.13	0.16	0.19	0.23
21	10.40	0.03	0.05	0.06	0.09	0.12	0.15	0.18	0.22	0.26
25	11.80	0.03	0.05	0.07	0.10	0.13	0.17	0.20	0.25	0.29
30	15.00	0.03	0.04	0.06	0.08	0.11	0.14	0.17	0.20	0.24
35	15.00	0.04	0.07	0.09	0.13	0.17	0.21	0.26	0.32	0.38
40	17.70	0.04	0.06	0.08	0.11	0.15	0.19	0.23	0.28	0.33
50	22.50	0.04	0.06	0.08	0.12	0.15	0.19	0.24	0.28	0.34
57	24.90	0.04	0.06	0.09	0.12	0.16	0.21	0.25	0.31	0.37
66	27.60	0.05	0.07	0.11	0.15	0.19	0.24	0.30	0.36	0.43
80	30.30	0.06	0.09	0.13	0.18	0.23	0.29	0.36	0.43	0.52
100	39.90	0.05	0.08	0.11	0.15	0.20	0.25	0.31	0.37	0.44
120	54.00	0.03	0.05	0.08	0.11	0.14	0.17	0.22	0.26	0.31

Dampers

Energy Wheel Dampers

Table 82. Energy wheel recirculation damper performance data

Unit size	Area (ft ²)	Unducted Pressure Drop							
		400	500	600	700	800	900	1000	1100
3	2.21	0.04	0.06	0.09	0.12	0.16	0.20	0.25	0.30
4	2.76	0.04	0.06	0.08	0.12	0.15	0.19	0.24	0.29
6	2.76	0.04	0.06	0.08	0.12	0.15	0.19	0.24	0.29
8	3.40	0.04	0.06	0.08	0.11	0.15	0.18	0.23	0.28
10	4.46	0.04	0.06	0.08	0.11	0.14	0.18	0.22	0.27
12	4.95	0.03	0.05	0.08	0.11	0.14	0.18	0.22	0.26
14	5.48	0.03	0.05	0.08	0.11	0.14	0.17	0.22	0.26
17	5.48	0.03	0.05	0.08	0.11	0.14	0.17	0.22	0.26
21	6.26	0.04	0.06	0.09	0.12	0.16	0.20	0.25	0.30
25	6.26	0.04	0.06	0.09	0.12	0.16	0.20	0.25	0.30
30	7.57	0.04	0.06	0.08	0.12	0.15	0.19	0.24	0.29
35	8.20	0.04	0.06	0.08	0.11	0.15	0.19	0.23	0.28
40	9.41	0.04	0.06	0.08	0.11	0.15	0.18	0.23	0.28
50	10.67	0.04	0.06	0.08	0.11	0.14	0.18	0.22	0.27
Unit size	Area (ft ²)	Unducted Pressure Drop							
		1200	1400	1600	1800	2000	2200	2400	2600
3	2.21	0.36	0.48	0.63	0.80	0.99	1.20	1.42	1.67
4	2.76	0.34	0.46	0.60	0.76	0.94	1.14	1.36	1.59

Table 82. Energy wheel recirculation damper performance data (continued)

6	2.76	0.34	0.46	0.60	0.76	0.94	1.14	1.36	1.59
8	3.40	0.33	0.45	0.58	0.74	0.91	1.10	1.31	1.54
10	4.46	0.32	0.43	0.56	0.71	0.88	1.07	1.27	1.49
12	4.95	0.31	0.43	0.56	0.71	0.87	1.06	1.26	1.47
14	5.48	0.31	0.42	0.55	0.70	0.86	1.05	1.24	1.46
17	5.48	0.31	0.42	0.55	0.70	0.86	1.05	1.24	1.46
21	6.26	0.35	0.48	0.63	0.79	0.98	1.19	1.41	1.66
25	6.26	0.35	0.48	0.63	0.79	0.98	1.19	1.41	1.66
30	7.57	0.34	0.46	0.60	0.76	0.94	1.14	1.36	1.59
35	8.20	0.34	0.46	0.60	0.75	0.93	1.13	1.34	1.57
40	9.41	0.33	0.45	0.58	0.74	0.91	1.10	1.31	1.54
50	10.67	0.32	0.44	0.57	0.73	0.90	1.08	1.29	1.51



Performance Data

Table 83. Energy wheel bypass damper performance data

Unit size	Wheel nom. cfm	Area (ft ²)	Unducted Pressure Drop															
			400	500	600	700	800	900	1000	1100	1200	1400	1600	1800	2000	2200	2400	2600
4	900	1.03	0.04	0.07	0.09	0.13	0.17	0.21	0.26	0.32	0.38	0.51	0.67	0.85	1.05	1.27	1.51	1.77
4	1500	1.03	0.04	0.07	0.09	0.13	0.17	0.21	0.26	0.32	0.38	0.51	0.67	0.85	1.05	1.27	1.51	1.77
4	2200	1.03	0.04	0.07	0.09	0.13	0.17	0.21	0.26	0.32	0.38	0.51	0.67	0.85	1.05	1.27	1.51	1.77
6	900	1.03	0.04	0.07	0.09	0.13	0.17	0.21	0.26	0.32	0.38	0.51	0.67	0.85	1.05	1.27	1.51	1.77
6	1500	1.03	0.04	0.07	0.09	0.13	0.17	0.21	0.26	0.32	0.38	0.51	0.67	0.85	1.05	1.27	1.51	1.77
6	2200	1.03	0.04	0.07	0.09	0.13	0.17	0.21	0.26	0.32	0.38	0.51	0.67	0.85	1.05	1.27	1.51	1.77
8	1500	1.83	0.04	0.06	0.08	0.11	0.15	0.19	0.23	0.28	0.33	0.45	0.59	0.75	0.92	1.12	1.33	1.56
8	2200	1.03	0.04	0.07	0.09	0.13	0.17	0.21	0.26	0.32	0.38	0.51	0.67	0.85	1.05	1.27	1.51	1.77
8	3000	1.83	0.04	0.06	0.08	0.11	0.15	0.19	0.23	0.28	0.33	0.45	0.59	0.75	0.92	1.12	1.33	1.56
10	2200	1.83	0.04	0.06	0.08	0.11	0.15	0.19	0.23	0.28	0.33	0.45	0.59	0.75	0.92	1.12	1.33	1.56
10	3000	1.83	0.04	0.06	0.08	0.11	0.15	0.19	0.23	0.28	0.33	0.45	0.59	0.75	0.92	1.12	1.33	1.56
10	4000	2.38	0.04	0.06	0.08	0.11	0.14	0.18	0.22	0.27	0.32	0.44	0.57	0.72	0.89	1.08	1.28	1.50
10	5000	2.38	0.04	0.06	0.08	0.11	0.14	0.18	0.22	0.27	0.32	0.44	0.57	0.72	0.89	1.08	1.28	1.50
12	2200	1.83	0.04	0.06	0.08	0.11	0.15	0.19	0.23	0.28	0.33	0.45	0.59	0.75	0.92	1.12	1.33	1.56
12	3000	1.83	0.04	0.06	0.08	0.11	0.15	0.19	0.23	0.28	0.33	0.45	0.59	0.75	0.92	1.12	1.33	1.56
12	4000	2.38	0.04	0.06	0.08	0.11	0.14	0.18	0.22	0.27	0.32	0.44	0.57	0.72	0.89	1.08	1.28	1.50
12	5000	3.05	0.03	0.05	0.08	0.11	0.14	0.18	0.22	0.26	0.31	0.42	0.55	0.70	0.87	1.05	1.25	1.46
12	6000	3.05	0.03	0.05	0.08	0.11	0.14	0.18	0.22	0.26	0.31	0.42	0.55	0.70	0.87	1.05	1.25	1.46
14	2200	2.38	0.04	0.06	0.08	0.11	0.14	0.18	0.22	0.27	0.32	0.44	0.57	0.72	0.89	1.08	1.28	1.50
14	3000	1.83	0.04	0.06	0.08	0.11	0.15	0.19	0.23	0.28	0.33	0.45	0.59	0.75	0.92	1.12	1.33	1.56
14	4000	2.38	0.04	0.06	0.08	0.11	0.14	0.18	0.22	0.27	0.32	0.44	0.57	0.72	0.89	1.08	1.28	1.50
14	5000	3.05	0.03	0.05	0.08	0.11	0.14	0.18	0.22	0.26	0.31	0.42	0.55	0.70	0.87	1.05	1.25	1.46
14	6000	3.05	0.03	0.05	0.08	0.11	0.14	0.18	0.22	0.26	0.31	0.42	0.55	0.70	0.87	1.05	1.25	1.46
14	7000	3.05	0.03	0.05	0.08	0.11	0.14	0.18	0.22	0.26	0.31	0.42	0.55	0.70	0.87	1.05	1.25	1.46
17	3000	3.05	0.03	0.05	0.08	0.11	0.14	0.18	0.22	0.26	0.31	0.42	0.55	0.70	0.87	1.05	1.25	1.46
17	4000	2.38	0.04	0.06	0.08	0.11	0.14	0.18	0.22	0.27	0.32	0.44	0.57	0.72	0.89	1.08	1.28	1.50
17	5000	3.05	0.03	0.05	0.08	0.11	0.14	0.18	0.22	0.26	0.31	0.42	0.55	0.70	0.87	1.05	1.25	1.46
17	6000	3.51	0.03	0.05	0.08	0.10	0.14	0.17	0.21	0.26	0.31	0.42	0.55	0.69	0.86	1.04	1.23	1.45
17	7000	3.51	0.03	0.05	0.08	0.10	0.14	0.17	0.21	0.26	0.31	0.42	0.55	0.69	0.86	1.04	1.23	1.45

Table 83. Energy wheel bypass damper performance data (continued)

Unit size	Wheel nom. cfm	Area (ft ²)	Unducted Pressure Drop															
			400	500	600	700	800	900	1000	1100	1200	1400	1600	1800	2000	2200	2400	2600
21	3000	3.05	0.03	0.05	0.08	0.11	0.14	0.18	0.22	0.26	0.31	0.42	0.55	0.70	0.87	1.05	1.25	1.46
21	4000	5.09	0.02	0.04	0.05	0.07	0.10	0.12	0.15	0.18	0.22	0.29	0.38	0.48	0.60	0.72	0.86	1.01
21	5000	3.05	0.03	0.05	0.08	0.11	0.14	0.18	0.22	0.26	0.31	0.42	0.55	0.70	0.87	1.05	1.25	1.46
21	6000	3.51	0.03	0.05	0.08	0.10	0.14	0.17	0.21	0.26	0.31	0.42	0.55	0.69	0.86	1.04	1.23	1.45
21	7000	3.77	0.03	0.05	0.08	0.10	0.14	0.17	0.21	0.26	0.31	0.42	0.54	0.69	0.85	1.03	1.23	1.44
21	8500	4.00	0.04	0.06	0.09	0.12	0.15	0.19	0.24	0.29	0.35	0.47	0.62	0.78	0.96	1.16	1.38	1.62
25	4000	5.09	0.02	0.04	0.05	0.07	0.10	0.12	0.15	0.18	0.22	0.29	0.38	0.48	0.60	0.72	0.86	1.01
25	5000	5.09	0.02	0.04	0.05	0.07	0.10	0.12	0.15	0.18	0.22	0.29	0.38	0.48	0.60	0.72	0.86	1.01
25	6000	5.09	0.02	0.04	0.05	0.07	0.10	0.12	0.15	0.18	0.22	0.29	0.38	0.48	0.60	0.72	0.86	1.01
25	7000	3.77	0.03	0.05	0.08	0.10	0.14	0.17	0.21	0.26	0.31	0.42	0.54	0.69	0.85	1.03	1.23	1.44
25	8500	6.31	0.03	0.04	0.06	0.08	0.11	0.14	0.17	0.20	0.24	0.33	0.43	0.55	0.67	0.81	0.97	1.14
30	4000	5.09	0.02	0.04	0.05	0.07	0.10	0.12	0.15	0.18	0.22	0.29	0.38	0.48	0.60	0.72	0.86	1.01
30	5000	5.09	0.02	0.04	0.05	0.07	0.10	0.12	0.15	0.18	0.22	0.29	0.38	0.48	0.60	0.72	0.86	1.01
30	6000	5.09	0.02	0.04	0.05	0.07	0.10	0.12	0.15	0.18	0.22	0.29	0.38	0.48	0.60	0.72	0.86	1.01
30	7000	3.77	0.03	0.05	0.08	0.10	0.14	0.17	0.21	0.26	0.31	0.42	0.54	0.69	0.85	1.03	1.23	1.44
30	8500	6.31	0.03	0.04	0.06	0.08	0.11	0.14	0.17	0.20	0.24	0.33	0.43	0.55	0.67	0.81	0.97	1.14
30	10500	5.09	0.02	0.04	0.05	0.07	0.10	0.12	0.15	0.18	0.22	0.29	0.38	0.48	0.60	0.72	0.86	1.01
30	12500	6.31	0.03	0.04	0.06	0.08	0.11	0.14	0.17	0.20	0.24	0.33	0.43	0.55	0.67	0.81	0.97	1.14
35	5000	5.09	0.02	0.04	0.05	0.07	0.10	0.12	0.15	0.18	0.22	0.29	0.38	0.48	0.60	0.72	0.86	1.01
35	6000	5.09	0.02	0.04	0.05	0.07	0.10	0.12	0.15	0.18	0.22	0.29	0.38	0.48	0.60	0.72	0.86	1.01
35	7000	5.09	0.02	0.04	0.05	0.07	0.10	0.12	0.15	0.18	0.22	0.29	0.38	0.48	0.60	0.72	0.86	1.01
35	8500	6.31	0.03	0.04	0.06	0.08	0.11	0.14	0.17	0.20	0.24	0.33	0.43	0.55	0.67	0.81	0.97	1.14
35	10500	5.09	0.02	0.04	0.05	0.07	0.10	0.12	0.15	0.18	0.22	0.29	0.38	0.48	0.60	0.72	0.86	1.01
35	12500	6.31	0.03	0.04	0.06	0.08	0.11	0.14	0.17	0.20	0.24	0.33	0.43	0.55	0.67	0.81	0.97	1.14
35	15000	7.28	0.03	0.04	0.06	0.08	0.10	0.13	0.16	0.20	0.24	0.32	0.42	0.53	0.65	0.79	0.94	1.10
35	17500	8.20	0.03	0.04	0.06	0.08	0.10	0.13	0.16	0.19	0.23	0.31	0.41	0.52	0.64	0.77	0.92	1.08
40	5000	5.09	0.02	0.04	0.05	0.07	0.10	0.12	0.15	0.18	0.22	0.29	0.38	0.48	0.60	0.72	0.86	1.01
40	6000	5.09	0.02	0.04	0.05	0.07	0.10	0.12	0.15	0.18	0.22	0.29	0.38	0.48	0.60	0.72	0.86	1.01
40	7000	5.09	0.02	0.04	0.05	0.07	0.10	0.12	0.15	0.18	0.22	0.29	0.38	0.48	0.60	0.72	0.86	1.01

Table 83. Energy wheel bypass damper performance data (continued)

Unit size	Wheel nom. cfm	Area (ft ²)	Unducted Pressure Drop															
			400	500	600	700	800	900	1000	1100	1200	1400	1600	1800	2000	2200	2400	2600
40	8500	6.31	0.03	0.04	0.06	0.08	0.11	0.14	0.17	0.20	0.24	0.33	0.43	0.55	0.67	0.81	0.97	1.14
40	10500	5.09	0.02	0.04	0.05	0.07	0.10	0.12	0.15	0.18	0.22	0.29	0.38	0.48	0.60	0.72	0.86	1.01
40	12500	6.31	0.03	0.04	0.06	0.08	0.11	0.14	0.17	0.20	0.24	0.33	0.43	0.55	0.67	0.81	0.97	1.14
40	15000	7.28	0.03	0.04	0.06	0.08	0.10	0.13	0.16	0.20	0.24	0.32	0.42	0.53	0.65	0.79	0.94	1.10
40	17500	8.20	0.03	0.04	0.06	0.08	0.10	0.13	0.16	0.19	0.23	0.31	0.41	0.52	0.64	0.77	0.92	1.08
40	20000	9.90	0.02	0.04	0.06	0.08	0.10	0.13	0.16	0.19	0.22	0.30	0.40	0.50	0.62	0.75	0.90	1.05
50	7000	6.31	0.03	0.04	0.06	0.08	0.11	0.14	0.17	0.20	0.24	0.33	0.43	0.55	0.67	0.81	0.97	1.14
50	8500	6.31	0.03	0.04	0.06	0.08	0.11	0.14	0.17	0.20	0.24	0.33	0.43	0.55	0.67	0.81	0.97	1.14
50	10500	5.09	0.02	0.04	0.05	0.07	0.10	0.12	0.15	0.18	0.22	0.29	0.38	0.48	0.60	0.72	0.86	1.01
50	12500	6.31	0.03	0.04	0.06	0.08	0.11	0.14	0.17	0.20	0.24	0.33	0.43	0.55	0.67	0.81	0.97	1.14
50	15000	7.28	0.03	0.04	0.06	0.08	0.10	0.13	0.16	0.20	0.24	0.32	0.42	0.53	0.65	0.79	0.94	1.10
50	17500	8.20	0.03	0.04	0.06	0.08	0.10	0.13	0.16	0.19	0.23	0.31	0.41	0.52	0.64	0.77	0.92	1.08
50	20000	9.90	0.02	0.04	0.06	0.08	0.10	0.13	0.16	0.19	0.22	0.30	0.40	0.50	0.62	0.75	0.90	1.05
50	25000	10.96	0.02	0.04	0.06	0.08	0.10	0.12	0.15	0.19	0.22	0.30	0.39	0.50	0.61	0.74	0.88	1.04

Mixing Box Dampers

Mixing Box with Airfoil Blade Dampers

Table 84. Mixing box with front, back, top, and bottom airfoil blade dampers (unducted)

Unit Size	Area (ft ²)	Static Pressure Drop (inches wg) by Damper Face Velocity															
		400	500	600	700	800	900	1000	1100	1200	1400	1600	1800	2000	2200	2400	2600
3	1.29	0.05	0.07	0.11	0.14	0.19	0.24	0.29	0.36	0.42	0.58	0.75	0.95	1.17	1.42	1.69	1.99
4	1.87	0.04	0.06	0.09	0.13	0.16	0.21	0.26	0.31	0.37	0.50	0.66	0.83	1.03	1.25	1.48	1.74
6	2.45	0.04	0.06	0.09	0.12	0.15	0.20	0.24	0.29	0.35	0.47	0.62	0.78	0.96	1.17	1.39	1.63
8	3.33	0.04	0.06	0.08	0.11	0.15	0.19	0.23	0.28	0.33	0.45	0.58	0.74	0.91	1.11	1.32	1.54
10	4.16	0.04	0.06	0.08	0.11	0.14	0.18	0.22	0.27	0.32	0.43	0.57	0.72	0.89	1.07	1.28	1.50
12	5.10	0.03	0.05	0.08	0.11	0.14	0.18	0.22	0.26	0.31	0.43	0.56	0.70	0.87	1.05	1.25	1.47
14	5.66	0.03	0.05	0.07	0.10	0.12	0.16	0.19	0.24	0.28	0.38	0.50	0.63	0.78	0.94	1.12	1.31
17	6.99	0.03	0.05	0.07	0.09	0.12	0.15	0.19	0.23	0.27	0.37	0.49	0.62	0.76	0.92	1.09	1.28
21	8.64	0.03	0.05	0.07	0.09	0.12	0.15	0.19	0.23	0.27	0.37	0.48	0.60	0.75	0.90	1.07	1.26
25	10.36	0.03	0.04	0.06	0.09	0.11	0.14	0.17	0.21	0.25	0.34	0.45	0.57	0.70	0.85	1.01	1.18
30	12.04	0.03	0.04	0.06	0.08	0.11	0.14	0.17	0.21	0.25	0.34	0.44	0.56	0.69	0.84	0.99	1.17
35	14.32	0.03	0.04	0.06	0.09	0.11	0.14	0.18	0.22	0.26	0.35	0.46	0.58	0.72	0.87	1.03	1.21
40	16.29	0.03	0.04	0.06	0.09	0.11	0.14	0.18	0.22	0.26	0.35	0.46	0.58	0.72	0.87	1.03	1.21
50	18.59	0.03	0.04	0.06	0.09	0.11	0.14	0.18	0.21	0.25	0.35	0.45	0.57	0.71	0.85	1.02	1.19
57	22.79	0.03	0.04	0.06	0.08	0.11	0.14	0.17	0.20	0.24	0.33	0.43	0.55	0.68	0.82	0.97	1.14
66	26.04	0.03	0.04	0.06	0.08	0.11	0.14	0.17	0.20	0.24	0.33	0.43	0.54	0.67	0.81	0.96	1.13
80	30.83	0.03	0.04	0.06	0.08	0.10	0.13	0.16	0.20	0.23	0.32	0.42	0.53	0.65	0.78	0.93	1.10
100	39.78	0.03	0.04	0.06	0.08	0.10	0.13	0.16	0.19	0.23	0.31	0.40	0.51	0.63	0.76	0.91	1.06
120	47.87	0.03	0.04	0.06	0.08	0.10	0.13	0.16	0.19	0.23	0.31	0.41	0.52	0.64	0.78	0.92	1.08



Performance Data

Table 85. Mixing box with front, back, top, and bottom airfoil blade dampers (ducted)

Unit Size	Area (ft ²)	Static Pressure Drop (inches w.g.) by Damper Face Velocity															
		400	500	600	700	800	900	1000	1100	1200	1400	1600	1800	2000	2200	2400	2600
3	1.29	0.07	0.10	0.15	0.20	0.26	0.33	0.41	0.49	0.59	0.80	1.04	1.32	1.63	1.98	2.35	2.76
4	1.87	0.05	0.07	0.11	0.15	0.19	0.24	0.30	0.36	0.43	0.59	0.77	0.97	1.20	1.45	1.72	2.02
6	2.45	0.04	0.06	0.09	0.12	0.16	0.20	0.25	0.30	0.36	0.49	0.64	0.81	1.00	1.21	1.44	1.69
8	3.33	0.03	0.05	0.08	0.10	0.14	0.17	0.21	0.26	0.31	0.42	0.55	0.69	0.86	1.04	1.23	1.45
10	4.16	0.03	0.05	0.07	0.10	0.12	0.16	0.19	0.24	0.28	0.38	0.50	0.63	0.78	0.94	1.12	1.32
12	5.10	0.03	0.05	0.07	0.09	0.12	0.15	0.18	0.22	0.26	0.36	0.46	0.59	0.73	0.88	1.04	1.23
14	5.66	0.02	0.03	0.05	0.06	0.08	0.10	0.13	0.16	0.19	0.25	0.33	0.42	0.52	0.62	0.74	0.87
17	6.99	0.02	0.03	0.04	0.06	0.08	0.10	0.12	0.14	0.17	0.23	0.30	0.38	0.47	0.57	0.68	0.79
21	8.64	0.02	0.03	0.04	0.05	0.07	0.09	0.11	0.13	0.16	0.21	0.28	0.35	0.43	0.53	0.63	0.73
25	10.36	0.01	0.02	0.03	0.04	0.05	0.07	0.08	0.10	0.12	0.16	0.21	0.27	0.33	0.40	0.48	0.56
30	12.04	0.01	0.02	0.03	0.04	0.05	0.06	0.08	0.10	0.11	0.15	0.20	0.26	0.32	0.38	0.45	0.53
35	14.32	0.01	0.02	0.03	0.04	0.05	0.07	0.08	0.10	0.12	0.16	0.21	0.26	0.33	0.39	0.47	0.55
40	16.29	0.01	0.02	0.03	0.04	0.05	0.07	0.08	0.10	0.12	0.16	0.21	0.27	0.33	0.40	0.48	0.56
50	18.59	0.01	0.02	0.03	0.04	0.05	0.06	0.08	0.10	0.11	0.16	0.20	0.26	0.32	0.38	0.46	0.54
57	22.79	0.01	0.02	0.02	0.03	0.04	0.05	0.06	0.08	0.09	0.13	0.16	0.21	0.26	0.31	0.37	0.43
66	26.04	0.01	0.02	0.02	0.03	0.04	0.05	0.06	0.07	0.09	0.12	0.16	0.20	0.24	0.29	0.35	0.41
80	30.83	0.01	0.01	0.02	0.03	0.03	0.04	0.05	0.06	0.07	0.10	0.13	0.17	0.21	0.25	0.30	0.35
100	39.78	0.01	0.01	0.02	0.02	0.03	0.04	0.04	0.05	0.06	0.09	0.11	0.14	0.17	0.21	0.25	0.30
120	47.87	0.01	0.01	0.02	0.02	0.03	0.04	0.05	0.06	0.07	0.09	0.12	0.15	0.18	0.22	0.26	0.31

Mixing Box with Traq Dampers
Table 86. Mixing box with front/back/top standard and low-flow Traq dampers

Unit Size	Damper Size (in)	Damper Quantity	Area (sq ft)	Traq Damper Velocity (fpm) vs. Delta P (w.g.)								
				800	900	1000	1100	1200	1300	1400	1500	1600
3	13	1	0.92	0.06	0.07	0.09	0.11	0.13	0.15	0.17	0.20	0.23
4	13	2	1.84	0.06	0.07	0.09	0.11	0.13	0.15	0.17	0.20	0.23
6	13	2	1.84	0.06	0.07	0.09	0.11	0.13	0.15	0.17	0.20	0.23
8	13	3	2.77	0.06	0.07	0.09	0.11	0.13	0.15	0.17	0.20	0.23
10	13	3	2.77	0.06	0.07	0.09	0.11	0.13	0.15	0.17	0.20	0.23
12	16	3	4.19	0.06	0.07	0.09	0.11	0.13	0.15	0.17	0.20	0.23
14	16	3	4.19	0.06	0.07	0.09	0.11	0.13	0.15	0.17	0.20	0.23
17	16	3	4.19	0.06	0.07	0.09	0.11	0.13	0.15	0.17	0.20	0.23
21	20	3	6.54	0.06	0.07	0.09	0.10	0.12	0.14	0.17	0.19	0.21
25	20	3	6.54	0.06	0.07	0.09	0.10	0.12	0.14	0.17	0.19	0.21
30	24	3	9.42	0.06	0.07	0.09	0.10	0.12	0.14	0.17	0.19	0.21
35	24	3	9.42	0.06	0.07	0.09	0.10	0.12	0.14	0.17	0.19	0.21
40	24	3	9.42	0.06	0.07	0.09	0.10	0.12	0.14	0.17	0.19	0.21
50	28	3	12.83	0.06	0.07	0.09	0.10	0.12	0.14	0.17	0.19	0.21
57	28	3	12.83	0.06	0.07	0.09	0.10	0.12	0.14	0.17	0.19	0.21
66	28	4	17.10	0.06	0.07	0.09	0.10	0.12	0.14	0.17	0.19	0.21
80	28	5	21.38	0.06	0.07	0.09	0.10	0.12	0.14	0.17	0.19	0.21
100	28	6	25.66	0.06	0.07	0.09	0.10	0.12	0.14	0.17	0.19	0.21
120	28	6	25.66	0.06	0.07	0.09	0.10	0.12	0.14	0.17	0.19	0.21

Notes:

1. Data a standard air density.
2. Traq damper airflow measurement station (AMS) ratings are based on AMCA Standard 610 Test Setup Figure 4 using differential pressure measurement with voltage signals from a Trane ventilation control module (VCM).
3. Performance of Traq dampers will be +/- 5 percent of data shown for AMCA 610 Test Setup Figure 4.
4. Sizes and shapes tested include 16-inch and 28-inch diameter circular. Rated sizes are from 13 inches to 24 inches diameter circular.



Performance Data

Table 87. Mixing box with front/back/top standard and low-flow Traq dampers

Unit Size	Traq Damper Size (in)	Traq Damper Quantity	Damper Area (sq ft)	Traq Damper Velocity (fpm) vs. Delta P (w.g.)								
				1700	1800	1900	2000	2100	2200	2300	2400	2500
3	13	1	0.92	0.26	0.29	0.32	0.35	0.39	0.43	0.47	0.51	0.56
4	13	2	1.84	0.26	0.29	0.32	0.35	0.39	0.43	0.47	0.51	0.56
6	13	2	1.84	0.26	0.29	0.32	0.35	0.39	0.43	0.47	0.51	0.56
8	13	3	2.77	0.26	0.29	0.32	0.35	0.39	0.43	0.47	0.51	0.56
10	13	3	2.77	0.26	0.29	0.32	0.35	0.39	0.43	0.47	0.51	0.56
12	16	3	4.19	0.26	0.29	0.32	0.35	0.39	0.43	0.47	0.51	0.56
14	16	3	4.19	0.26	0.29	0.32	0.35	0.39	0.43	0.47	0.51	0.56
17	16	3	4.19	0.26	0.29	0.32	0.35	0.39	0.43	0.47	0.51	0.56
21	20	3	6.54	0.24	0.27	0.30	0.33	0.37	0.40	0.44	0.48	0.52
25	20	3	6.54	0.24	0.27	0.30	0.33	0.37	0.40	0.44	0.48	0.52
30	24	3	9.42	0.24	0.27	0.30	0.33	0.37	0.40	0.44	0.48	0.52
35	24	3	9.42	0.24	0.27	0.30	0.33	0.37	0.40	0.44	0.48	0.52
40	24	3	9.42	0.24	0.27	0.30	0.33	0.37	0.40	0.44	0.48	0.52
50	28	3	12.83	0.24	0.27	0.30	0.33	0.37	0.40	0.44	0.48	0.52
57	28	3	12.83	0.24	0.27	0.30	0.33	0.37	0.40	0.44	0.48	0.52
66	28	4	17.10	0.24	0.27	0.30	0.33	0.37	0.40	0.44	0.48	0.52
80	28	5	21.38	0.24	0.27	0.30	0.33	0.37	0.40	0.44	0.48	0.52
100	28	6	25.66	0.24	0.27	0.30	0.33	0.37	0.40	0.44	0.48	0.52
120	28	6	25.66	0.24	0.27	0.30	0.33	0.37	0.40	0.44	0.48	0.52

Notes:

1. Data a standard air density.
2. Traq damper airflow measurement station (AMS) ratings are based on AMCA Standard 610 Test Setup Figure 4 using differential pressure measurement with voltage signals from a Trane ventilation control module (VCM).
3. Performance of Traq dampers will be +/- .5 percent of data shown for AMCA 610 Test Setup Figure 4.
4. Sizes and shapes tested include 16-inch and 28-inch diameter circular. Rated sizes are from 13 inches to 24 inches diameter circular.

AMCA 610 Test Performance for Traq Damper

Trane certifies that the Traq damper shown herein is licensed to bear the AMCA seal - Airflow Measurement Station Performance. The rating shown is based on tests and procedures performed in accordance with AMCA Publication 611 and complies with the requirements of the AMCA Certified Ratings Program.

Table 88. Air performance

Test Run	Reference Volume (cfm)	Indicated Volume (cfm)	Difference (percent)	Reference Volume (cfm)	Indicated Volume (cfm)	Difference (percent)
Traq 16-inch damper AMS			Traq 28-inch damper AMS			
1	3470	3351	-3.41	10714	10548	-1.55
2	2882	2773	-3.80	8817	8644	-1.96
3	2264	2211	-2.35	6997	6851	-2.09
4	1703	1676	-1.62	5063	4961	-2.00
5	1032	1019	-1.25	3126	3071	-1.76
6	506	505	-0.18	1363	1362	-0.06

Table 89. Airflow resistance

Test Run	Pressure Drop (in. w.g.)	Volume (cfm)	Velocity(fpm)	Pressure Drop (in. w.g.)	Volume (cfm)	Velocity(fpm)
Traq 16-inch damper AMS			Traq 28-inch damper AMS			
1	0.561	3469.70	2485.40	0.515	10738.60	2511.40
2	0.389	2895.70	2074.30	0.352	8856.50	2071.20
3	0.239	2276.30	1630.60	0.228	7029.20	1643.90
4	0.135	1710.20	1225.10	0.114	5085.50	1189.30
5	0.052	1035.00	741.40	0.041	3134.60	733.10
6	0.010	507.00	363.20	0.010	1364.40	319.10

Corresponding conversion formulas:

- Traq 16-inch AMS: Airflow = ((Volts-2)/8)*2475*Total Area (applicable for unit sizes 3-17).
- Traq 28-inch AMS: Airflow = ((Volts-2)/8)*2600*Total Area (applicable for units sizes 21-30).

See the *Performance Climate Changer™ Air Handlers Model CSAA Indoor and Outdoor Units Sizes 3 to 120 Installation, Operation, and Maintenance* (CLCH-SVX07*-EN) for Traq damper installation.

Diffuser

Table 90. Diffuser pressure drop

Unit Size	Static Pressure Drop (inches wg) by Face Velocity (fpm)								
	500	700	900	1100	1300	1500	1700	1900	2100
3-120	0.01	0.02	0.04	0.06	0.08	0.10	0.13	0.17	0.20

Table 91. Diffuser face area

Unit Size	3	4	6	8	10	12	14	17	21	25
Area (ft ²)	1.53	1.53	3.36	3.74	3.74	4.32	4.32	7.94	8.78	10.72
Unit Size	30	35	40	50	57	66	80	100	120	
Area (ft ²)	10.72	23.42	23.42	27.21	31.53	33.09	39.76	45.20	45.20	

Discharge Plenums

Figure 62. Horizontal plenum

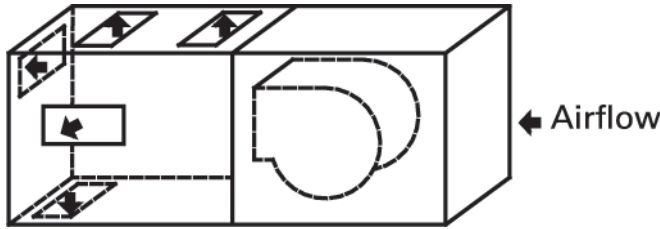

Figure 63. Vertical plenum

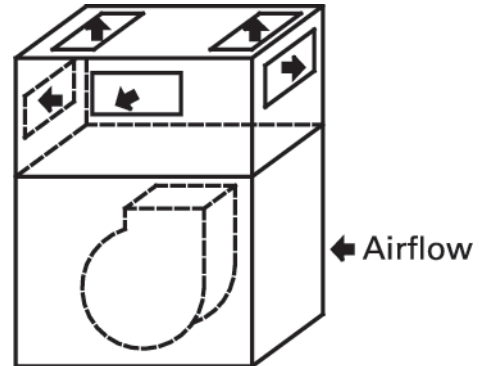

Table 92. Discharge plenums - default factory outlet areas (ft²)

Unit Size	Horizontal Plenum								Vertical Plenum					
	Rectangular Openings				Round Openings				Rectangular Openings			Round Openings		
	Front	Top	Bot- tom	Side	Front	Top	Bot- tom	Side	Front Back	Top	Side	Front Back	Top	Side
3	1.07	1.07	1.07	1.07	0.92	0.92	0.92	0.92	1.07	1.07	1.07	0.92	0.92	0.92
4	1.53	1.53	1.53	1.25	1.40	1.40	1.40	1.40	1.53	1.53	1.25	1.40	1.40	1.40
6	2.19	2.19	2.19	2.13	2.18	2.18	2.18	2.18	2.19	2.19	2.13	2.18	2.18	2.18
8	2.67	2.67	2.67	2.51	2.64	2.64	2.64	2.64	2.67	2.67	2.51	2.64	2.64	2.64
10	3.33	3.33	3.33	3.36	3.14	3.14	3.14	3.14	3.33	3.33	3.36	3.14	3.14	3.14
12	4.00	4.00	4.00	3.99	3.69	3.69	3.69	4.28	4.00	4.00	3.99	4.28	4.28	4.28
14	4.88	4.88	4.88	4.69	3.69	3.69	3.69	4.28	4.88	4.88	4.69	4.91	4.91	4.91
17	5.91	5.91	5.91	5.56	3.69	3.69	3.69	4.28	5.91	5.91	5.56	5.59	5.59	5.59
21	7.12	7.12	7.12	7.04	3.14	3.14	3.14	3.69	7.12	7.12	7.04	6.31	6.31	6.31
25	8.54	8.54	8.54	8.13	7.07	7.07	7.07	7.88	8.54	8.54	8.13	7.88	7.88	7.88
30	10.21	10.21	10.21	10.15	7.07	7.07	7.07	7.88	10.21	10.21	10.15	9.62	9.62	9.62
35	13.56	13.09	11.67	11.25	11.54	11.17	11.17	5.52	13.56	13.09	11.25	11.54	11.17	11.54
40	14.89	14.70	13.42	12.67	12.57	12.61	12.61	5.52	14.89	14.70	12.67	12.57	12.61	12.57
50	19.27	18.30	16.67	15.04	15.75	14.53	14.53	7.95	19.27	18.30	15.04	15.75	14.53	12.57
57	21.88	20.63	18.89	17.94	18.34	16.76	16.76	11.17	—	—	—	—	—	—
66	25.36	23.61	20.40	19.23	21.12	18.92	18.92	12.43	—	—	—	—	—	—
80	29.97	28.71	23.49	25.06	25.13	21.21	21.21	18.56	—	—	—	—	—	—
100	37.28	34.53	30.04	32.29	31.50	26.84	26.84	24.35	—	—	—	—	—	—
120	43.43	41.25	35.58	34.03	38.48	33.13	33.13	24.35	—	—	—	—	—	—

Notes:

1. Openings can be varied in number, size, and location within the Trane Select Assist Selection Software.
2. Sizes 35-120 have default multiple round openings as standard. 3. Bell mouth openings are available within the Trane Select Assist Selection Software.
3. Bell mouth openings are available within the Trane Select Assist Selection Software.

Table 93. Formulas to calculate pressure drop out of discharge plenums

For all plenum openings, use:

$$SP = K_t \bullet \left(\frac{OV_F}{4005} \right)^2 + 0.5 \bullet \left(\frac{OV_P}{4005} \right)^2$$

$$OV_F = CFM/OA_F$$

$$OV_P = CFM/OA_P$$

 OV_F = fan outlet velocity

Where:

 OA_F = fan outlet area (see General Data)

 SP = static pressure drop

 OV_P = plenum opening outlet velocity

 K_t = value from the below Discharge Plenums - K_t values for factory openings for plenum fans table and Discharge Plenums - K_t values for factory openings for housed fans table.

 OA_P = plenum opening area (see the above Discharge plenums - default factory outlet areas (ft²) table.)

Table 94. Discharge plenums - K_t values for factory openings for plenum fans

Unit size	Discharge Location	Discharge
3-120	Rectangular Radial	2.00
	Rectangular Axial Discharge	2.50
	Round Radial	2.00
	Round Axial Discharge	2.50
	Bell mouth Radial	1.60
	Bell mouth Axial Discharge	1.80

Electric Heat - Draw Through

Table 95. Electric heat - draw through pressure drop

	Static Pressure Drop (inches w.g.) by Face Velocity (fpm)							
Face Velocity	350	400	450	500	550	600	650	700
Pressure Drop	0.06	0.08	0.10	0.12	0.15	0.17	0.20	0.24

Table 96. Electric heat - draw through area

Unit size	3	4	6	8	10	12	14	17
Area (ft ²)	2.18	3.79	4.73	6.43	8.52	10.54	11.70	14.58
Unit size	21	25	30	35	40	50	57	66
Area (ft ²)	17.57	21.13	25.52	30.97	34.98	45.17	52.25	62.65

Filters

Table 97. Maximum CFM for filters

Unit Size	Pleated Media		Permanent		Throwaway		High Efficiency		
	2-in. and 4-in. Flat	2-in. or 4-in. Angled	2-in. and 4-in. Flat	2-in. or 4-in. Angled	2-in. and 4-in. Flat	2-in. or 4-in. Angled	Long Cartridge/Bag	HEPA	4-in. High Efficiency
	625	625	800	800	500	500	625	600	625
3	2169	3475	2776	4448	1735	2780	2081	1200	2169
4	3475	5556	4448	7112	2780	4445	3475	1200	3475
6	4338	5556	5552	7112	3470	4445	4169	3600	4338
8	4581	6944	5864	8888	3665	5555	5000	4200	4581



Performance Data

Table 97. Maximum CFM for filters (continued)

Unit Size	Pleated Media		Permanent		Throwaway		High Efficiency		
	2-in. and 4-in. Flat	2-in. or 4-in. Angled	2-in. and 4-in. Flat	2-in. or 4-in. Angled	2-in. and 4-in. Flat	2-in. or 4-in. Angled	Long Cartridge/Bag	HEPA	4-in. High Efficiency
	625	625	800	800	500	500	625	600	625
10	6075	8681	7776	11,112	4860	6945	5419	5400	6075
12	8331	10,419	10,664	13,336	6665	8335	7706	6000	8331
14	9025	11,288	11,552	14,448	7220	9030	8400	6000	9025
17	11,806	18,056	15,112	23,112	9445	14,445	11,806	8400	11,806
21	13,456	20,831	17,224	26,664	10,765	16,665	13,750	12,600	13,456
25	16,944	31,250	21,688	40,000	13,555	25,000	16,250	14,400	16,944
30	19,025	35,419	24,352	45,336	15,220	28,335	17,638	16,800	19,025
35	23,263	39,581	29,776	50,664	18,610	31,665	21,669	18,000	23,263
40	25,519	43,750	32,664	56,000	20,415	35,000	22,500	22,200	25,519
50	34,375	62,500	44,000	80,000	27,500	50,000	31,250	27,600	34,375
57	39,581	62,500	50,664	80,000	31,665	50,000	37,500	34,200	39,581
66	47,225	70,831	60,448	90,664	37,780	56,665	41,669	39,600	47,225
80	53,475	94,444	68,448	120,888	42,780	75,555	55,000	45,600	53,475
100	65,106	104,169	83,336	133,336	52,085	83,335	70,831	61,200	65,106
120	76,388	121,525	97,776	155,552	61,110	97,220	83,750	71,400	76,388

Table 98. Filter area (ft.²)

Unit Size	Side-load 2-in. and 4-in. Flat	Side-load 2-in. and 4-in. Angled	Side-load Bag/Cartridge	Front-Load Bag/Cartridge Filter	Front-load HEPA
3	3.47	5.56	3.33	2.00	2.00
4	5.56	8.89	5.56	2.00	2.00
6	6.94	8.89	6.67	6.00	6.00
8	7.33	11.11	8.00	6.00	7.00
10	9.72	13.89	8.67	8.00	9.00
12	13.33	16.67	12.33	10.00	10.00
14	14.44	18.06	13.44	10.00	10.00
17	18.89	28.89	18.89	14.00	14.00
21	21.53	33.33	22.00	18.00	21.00
25	27.11	50.00	26.00	24.00	24.00
30	30.44	56.67	28.22	28.00	28.00
35	37.22	63.33	34.67	34.00	30.00
40	40.83	70.00	36.00	38.00	37.00
50	55.00	100.00	50.00	50.00	46.00
57	63.33	100.00	60.00	60.00	57.00
66	75.56	113.33	66.67	66.00	66.00
80	85.56	151.11	88.00	86.00	76.00

Table 98. Filter area (ft.²) (continued)

Unit Size	Side-load 2-in. and 4-in. Flat	Side-load 2-in. and 4-in. Angled	Side-load Bag/Cartridge	Front-Load Bag/Cartridge Filter	Front-load HEPA
100	104.17	166.67	113.33	106.00	102.00
120	122.22	194.44	134.00	124.00	119.00

Table 99. Filters (clean) performance data

Filter Type	Static Pressure Drop (inches wg) by Filter Face Velocity (fpm)								
	200	250	300	350	400	450	500	550	600
2-inch permanent – MERV 2	0.01	0.02	0.03	0.04	0.05	0.06	0.07	0.09	0.11
2-inch disposable (TA) – MERV 5	0.04	0.06	0.08	0.10	0.13	0.15	0.18	—	—
2-inch pleated media – MERV 8	0.08	0.11	0.14	0.18	0.22	0.26	0.30	0.34	0.39
2-inch pleated media – coated – MERV 7	0.08	0.11	0.14	0.18	0.21	0.26	0.30	0.35	0.40
4-inch pleated media – MERV 8	0.04	0.06	0.08	0.11	0.13	0.16	0.19	0.22	0.25
4-inch pleated media – coated – MERV 7	0.04	0.06	0.09	0.12	0.16	0.20	0.25	0.30	0.36
4-inch high efficient – 65% efficient – MERV 11	0.07	0.10	0.12	0.15	0.18	0.21	0.24	0.27	0.30
4-inch high efficient – 95% efficient – MERV 15	0.16	0.20	0.25	0.29	0.34	0.39	0.44	0.49	0.54
12-inch cartridge – 65% efficient – MERV 11	0.06	0.09	0.12	0.15	0.19	0.23	0.27	0.31	0.36
12-inch cartridge – 95% efficient – MERV 15	0.11	0.14	0.18	0.22	0.26	0.30	0.35	0.39	0.44
18-inch bag – 65% efficient – MERV 12	0.18	0.22	0.27	0.31	0.35	0.39	0.44	0.48	0.52
18-inch bag – 85% efficient – MERV 13	0.20	0.25	0.30	0.35	0.41	0.46	0.51	0.56	0.61
18-inch bag – 95% efficient – MERV 15	0.23	0.28	0.34	0.39	0.45	0.50	0.56	0.61	0.66
30-inch bag – 65% efficient – MERV 12	0.07	0.10	0.13	0.17	0.21	0.26	0.31	0.36	0.42
30-inch bag – 85% efficient – MERV 13	0.09	0.11	0.15	0.18	0.22	0.26	0.31	0.35	0.40
30-inch bag – 95% efficient – MERV 15	0.17	0.22	0.27	0.32	0.37	0.42	0.47	0.52	0.58
HEPA - 99.97% efficient - DOP	0.47	0.60	0.74	0.89	1.04	1.20	1.37	1.54	1.72

Table 100. Filters (mid-life) performance data

Filter Type	Static Pressure Drop (inches wg) by Filter Face Velocity (fpm)								
	200	250	300	350	400	450	500	550	600
2-inch permanent – MERV 2	0.51	0.51	0.52	0.52	0.53	0.53	0.54	0.55	0.55
2-inch disposable (TA) – MERV 5	0.52	0.53	0.54	0.55	0.57	0.58	0.59	—	—
2-inch pleated media – MERV 8	0.54	0.56	0.57	0.59	0.61	0.63	0.65	0.67	0.69
2-inch pleated media – coated – MERV 7	0.54	0.56	0.57	0.59	0.61	0.63	0.65	0.67	0.70
4-inch pleated media – MERV 8	0.52	0.53	0.54	0.56	0.57	0.58	0.59	0.61	0.62
4-inch pleated media – coated – MERV 7	0.52	0.53	0.55	0.57	0.59	0.61	0.63	0.65	0.67
4-inch high efficient – 65% efficient – MERV 11	0.64	0.65	0.66	0.68	0.69	0.70	0.72	0.73	0.75
4-inch high efficient – 95% efficient – MERV 15	0.68	0.70	0.72	0.75	0.77	0.79	0.82	0.84	0.87
12-inch cartridge – 65% efficient – MERV 11	0.63	0.65	0.66	0.68	0.70	0.72	0.74	0.76	0.78
12-inch cartridge – 95% efficient – MERV 15	0.65	0.67	0.69	0.71	0.73	0.75	0.77	0.80	0.82



Performance Data

Table 100. Filters (mid-life) performance data (continued)

Filter Type	Static Pressure Drop (inches wg) by Filter Face Velocity (fpm)								
	200	250	300	350	400	450	500	550	600
18-inch bag – 65% efficient – MERV 12	0.69	0.71	0.73	0.75	0.77	0.80	0.82	0.84	0.86
18-inch bag – 85% efficient – MERV 13	0.70	0.73	0.75	0.78	0.80	0.83	0.85	0.88	0.90
18-inch bag – 95% efficient – MERV 15	0.71	0.74	0.77	0.80	0.82	0.85	0.88	0.90	0.93
30-inch bag – 65% efficient – MERV 12	0.63	0.65	0.67	0.69	0.71	0.73	0.76	0.78	0.80
30-inch bag – 85% efficient – MERV 13	0.64	0.66	0.68	0.70	0.71	0.73	0.76	0.78	0.80
30-inch bag – 95% efficient – MERV 15	0.69	0.71	0.73	0.76	0.78	0.81	0.83	0.86	0.89
HEPA - 99.97% efficient - DOP	1.23	1.30	1.37	1.44	1.52	1.60	1.68	1.77	1.86

Table 101. Filters (dirty) performance data

Filter Type	Static Pressure Drop (inches wg) by Filter Face Velocity (fpm)								
	200	250	300	350	400	450	500	550	600
2-inch permanent – MERV 2	1.00	1.00	1.00	1.00	1.00	1.00	1.00	1.00	1.00
2-inch disposable (TA) – MERV 5	1.00	1.00	1.00	1.00	1.00	1.00	1.00	—	—
2-inch pleated media – MERV 8	1.00	1.00	1.00	1.00	1.00	1.00	1.00	1.00	1.00
2-inch pleated media – coated – MERV 7	1.00	1.00	1.00	1.00	1.00	1.00	1.00	1.00	1.00
4-inch pleated media – MERV 8	1.00	1.00	1.00	1.00	1.00	1.00	1.00	1.00	1.00
4-inch pleated media – coated – MERV 7	1.00	1.00	1.00	1.00	1.00	1.00	1.00	1.00	1.00
4-inch high efficient – 65% efficient – MERV 11	1.20	1.20	1.20	1.20	1.20	1.20	1.20	1.20	1.20
4-inch high efficient – 95% efficient – MERV 15	1.20	1.20	1.20	1.20	1.20	1.20	1.20	1.20	1.20
12-inch cartridge – 65% efficient – MERV 11	1.20	1.20	1.20	1.20	1.20	1.20	1.20	1.20	1.20
12-inch cartridge – 95% efficient – MERV 15	1.20	1.20	1.20	1.20	1.20	1.20	1.20	1.20	1.20
18-inch bag – 65% efficient – MERV 12	1.20	1.20	1.20	1.20	1.20	1.20	1.20	1.20	1.20
18-inch bag – 85% efficient – MERV 13	1.20	1.20	1.20	1.20	1.20	1.20	1.20	1.20	1.20
18-inch bag – 95% efficient – MERV 15	1.20	1.20	1.20	1.20	1.20	1.20	1.20	1.20	1.20
30-inch bag – 65% efficient – MERV 12	1.20	1.20	1.20	1.20	1.20	1.20	1.20	1.20	1.20
30-inch bag – 85% efficient – MERV 13	1.20	1.20	1.20	1.20	1.20	1.20	1.20	1.20	1.20
30-inch bag – 95% efficient – MERV 15	1.20	1.20	1.20	1.20	1.20	1.20	1.20	1.20	1.20
HEPA - 99.97% efficient - DOP	2.00	2.00	2.00	2.00	2.00	2.00	2.00	2.00	2.00

Hoods

Table 102. Exhaust hood performance data

Face Velocity (FPM)	Static Pressure Drop (inches wg) by Face Velocity (fpm)									
	700	800	900	1000	1100	1200	1300	1400	1500	1600
Pressure drop	0.03	0.04	0.05	0.06	0.07	0.09	0.10	0.12	0.13	0.15

Table 103. Exhaust hood face area

Unit Size	3	4	6	8	10	12	14	17	21	25	30	35	40	50	57
Area (ft ²)	1.25	1.25	1.49	1.78	2.00	2.52	3.21	3.17	4.07	4.36	5.28	7.69	7.94	8.67	9.23

Table 104. Inlet hood performance data

	Static Pressure Drop (inches wg) by Face Velocity (fpm)						
Face Velocity (FPM)	300	500	700	900	1100	1300	1500
Pressure drop	0.04	0.11	0.20	0.32	0.47	0.65	0.85

Each air handler has a rated nominal airflow (for example, 1500 cfm for a size 3). This nominal airflow is a quick guide to figure unit size requirements. Although this is the nominal airflow of a given unit, each unit is capable of producing more, until something limits the ability of the unit to meet this higher airflow requirement such as coil face velocity, filter face velocity, or the outside air inlet hood eliminator velocity.

The eliminator in the inlet hood is rated to a maximum outside airflow. Above this limit, there is a high probability of bringing rain, water or snow into the unit, which could migrate to the conditioned space below. When selecting units for your application, remember not to undersize a unit to the point that the inlet hood eliminators can not handle the outside air cfm requirements. The following table shows the maximum airflow for inlet hoods.

Table 105. Inlet hood airflow limitations (cfm)

Unit size	Back inlet hood	Mixing Section		Economizer Section
		1 side inlet hood	2 side inlet hoods	Single inlet hood
3	2070	1440	2880	1504
4	5567	1440	2880	2917
6	6016	1890	3780	3625
8	8847	2415	4830	4628
10	7050	3050	6100	5257
12	9393	3841	7681	6190
14	10,185	5582	11,163	8248
17	11,789	4870	9741	9960
21	14,716	6524	13,047	11,928
25	17,054	6917	13,834	13,984
30	22,694	7742	15,483	15,752
35	24,316	12,199	24,397	18,222
40	27,434	12,640	25,280	22,288
50	32,700	15,808	31,617	25,968
57	37,677	14,933	29,865	27,112
66	51,988	15,039	30,077	34,008
80	55,539	17,943	35,887	40,824
80 Traq	—	19,633	39,265	—
100	65,029	23,239	46,477	50,520
100 Traq	—	41,463	82,926	—
120	77,916	26,797	53,595	58,240
120 Traq	—	40,231	80,462	—



Performance Data

Humidifiers

Table 106. Humidifier pressure drop

	Static Pressure Drop (inches w.g.) by Face Velocity (fpm)										
Face Velocity	400	450	500	550	600	650	700	750	800	850	900
Pressure drop	0.02	0.02	0.03	0.03	0.04	0.05	0.05	0.06	0.07	0.08	0.09

Table 107. Face area for building steam and atmospheric steam sources

Unit Size	Building Steam Source	Atmospheric Steam Source
	Area (ft. ²)	Area (ft. ²)
3	1.22	1.42
4	2.43	2.29
6	3.47	3.72
8	4.59	5.14
10	6.20	6.58
12	7.59	8.67
14	8.47	9.53
17	11.04	12.71
21	12.71	16.17
25	16.52	20.36
30	20.18	21.40
35	24.96	26.73
40	28.57	30.45
50	39.20	41.05
57	46.59	48.56
66	55.69	58.19
80	60.75	63.00
100	67.75	70.00
120	72.00	74.00

Silencers

Table 108. Silencer performance data

Length	Model	Unit Sizes	Pressure Drop (in. H ₂ O) by Face Velocity (fpm)						
			250	500	750	1000	1250	1500	1750
3 ft.	RD-ULV-F2	10	0.03	0.11	0.26	0.45	0.70	1.01	1.37
	RD-ULV-F3	3, 21, 25, 40, 66, 80	0.03	0.11	0.25	0.45	0.70	1.00	1.36
	RD-ULV-F4	50, 57, 100, 120	0.03	0.11	0.25	0.44	0.68	0.98	1.32
	RD-ULV-F5	8, 14, 17, 30, 35	0.03	0.12	0.27	0.47	0.73	1.05	1.43
	RD-ULV-F6	4, 6, 12	0.03	0.12	0.28	0.50	0.78	1.13	1.54
5 ft.	RD-ULV-F2	10	0.04	0.15	0.34	0.61	0.94	1.36	1.84
	RD-ULV-F3	3, 21, 25, 40, 66, 80	0.04	0.15	0.34	0.59	0.92	1.31	1.78
	RD-ULV-F4	50, 57, 100, 120	0.04	0.15	0.33	0.57	0.89	1.27	1.71
	RD-ULV-F5	8, 14, 17, 30, 35	0.04	0.15	0.34	0.61	0.94	1.35	1.83
	RD-ULV-F6	4, 6, 12	0.04	0.16	0.36	0.64	0.99	1.43	1.94

Table 109. Silencer face area

Unit Size	3	4	6	8	10	12	14	17	21	25
Area (ft ²)	4.30	6.25	7.99	10.09	12.48	15.19	16.53	20.07	24.41	29.03
Unit Size	30	35	40	50	57	66	80	100	120	
Area (ft ²)	34.18	40.50	45.77	58.43	66.66	78.20	92.42	114.70	135.66	

Trane Commercial Air Purification System (TCAPS)

Table 110. TCAPS pressure drop

	Static Pressure Drop (inches w.g.) by Face Velocity (fpm)								
Face Velocity	200	250	300	350	400	450	500	550	600
Pressure drop	0.008	0.013	0.019	0.026	0.034	0.043	0.053	0.064	0.076

Table 111. TCAPS face area

Unit Size	3	4	6	8	10	12	14	17	21	25
Area (ft ²)	3.15	5.21	6.29	7.39	8.14	11.51	12.59	17.79	20.82	24.41
Unit Size	30	35	40	50	57	66	80	100	120	—
Area (ft ²)	26.39	32.55	34.05	47.18	56.92	62.90	73.27	106.53	126.55	—



Electrical Data

Table 112. Current requirements — starter full load amps

Reference HP	Starter			
	200	230	460	575
1	4.80	4.20	2.10	1.70
1.5	6.90	6.00	3.00	2.40
2	7.80	6.80	3.40	2.70
3	11.00	9.60	4.80	3.90
5	17.50	15.20	7.60	6.10
7.5	25.30	22.00	11.00	9.00
10	32.20	28.00	14.00	11.00
15	48.30	42.00	21.00	17.00
20	62.10	54.00	27.00	22.00
25	78.20	68.00	34.00	27.00
30	92.00	80.00	40.00	32.00
40	120.00	104.00	52.00	41.00
50	—	130.00	65.00	52.00
60	—	—	77.00	62.00
75	—	—	96.00	77.00
100	—	—	124.00	99.00
125	—	—	—	125.00

Table 113. Current requirements — VFD

Reference HP	TR150 3-phase VFD Panel Amps				TR150 3-phase VFD with Bypass Panel Amps			
	200 V	230 V	460 V	575 V	200 V	230 V	460 V	575 V
1	4.20	4.20	2.10	3.90	3.57	3.57	1.96	1.50
1.5	6.80	6.80	3.40	3.90	6.56	6.56	2.65	2.65
2	6.80	6.80	3.40	3.90	6.56	6.56	3.40	2.65
3	9.60	9.60	4.80	3.90	11.50	9.60	4.80	3.90
5	15.20	15.20	8.20	6.10	18.40	15.20	8.20	6.10
7.5	22.00	22.00	11.00	9.00	27.60	22.00	11.00	8.74
10	28.00	28.00	14.00	11.00	37.95	28.00	14.00	11.00
15	42.00	42.00	21.00	18.00	54.05	42.00	21.00	18.00
20	59.40	59.40	27.00	22.00	59.40	59.40	27.00	22.00
25	74.80	74.80	34.00	27.00	74.80	74.80	34.00	27.00
30	88.00	88.00	40.00	34.00	88.00	88.00	40.00	34.00
40	115.00	115.00	52.00	41.00	115.00	115.00	52.00	41.00
50	143.00	143.00	65.00	52.00	—	143.00	65.00	52.00
60	—	—	80.00	62.00	—	—	80.00	62.00
75	—	—	105.00	83.00	—	—	105.00	83.00

Table 113. Current requirements — VFD (continued)

Reference HP	TR150 3-phase VFD Panel Amps				TR150 3-phase VFD with Bypass Panel Amps			
	200 V	230 V	460 V	575 V	200 V	230 V	460 V	575 V
100	—	—	130.00	100.00	—	—	130.00	100.00
125	—	—	160.00	131.00	—	—	160.00	131.00



Mechanical Specifications

Performance Climate Changer™ air handlers must be rigged, lifted, and installed in strict accordance with *Performance Climate Changer™ Air Handlers Model CSAA Indoor and Outdoor Units Sizes 3 to 120 Installation, Operation, and Maintenance manual* (CLCH-SVX07*-EN). The units are also to be installed in strict accordance with the specifications.

All units will be shipped with an integral base frame designed with the necessary number of lift points for safe installation. The lift points will be designed to accept standard rigging devices and be removable after installation. Units shipped in sections will have a minimum of four points of lift. Sizes 3-30 will also be shipped with a shipping skid designed for forklift transport.

Units will be shipped with a shipping skid designed for forklift transport and the integral base will be designed with the necessary number of lift points for safe installation. The lift points will be designed to accept standard rigging devices and removable after installation. Units shipped in sections will have a minimum of four points of lift.

Per ASHRAE 62.1 recommendation, units will be shipped stretch-wrapped to protect unit from in-transit rain and debris. Installing contractor is responsible for long-term storage in accordance with *Performance Climate Changer™ Air Handlers Model CSAA Indoor and Outdoor Units Sizes 3 to 120 Installation, Operation, and Maintenance manual* (CLCH-SVX07*-EN).

Certifications

UL and C-UL Listed

Unit shall be UL and C-UL Listed.

AHRI Standards

Air-handling performance data shall be certified in accordance with AHRI Standard 430. Unit sound performance data shall be provided using AHRI Standard 260 test methods and reported as sound power. Coil performance shall be certified in accordance with AHRI Standard 410.

Seismic Certification

Trane has qualified listed air-handling unit sizes 3-30 as certified for seismic applications in accordance with the following International Building Code (IBC) releases: IBC 2000, 2003, 2006, 2009, 2012, 2015, 2018, 2021, and 2024.

Seismic Qualification Testing and structural analysis shall be conducted in accordance with and strict adherence to the standards set forth within ASCE 7 by an independent approval agency with a complete list of certified models, options, and installation methods provided in an approved detailed report. The above referenced equipment shall be approved for seismic applications when properly installed and used as intended.

The basis of the certification shall be obtained through a combination of testing of the active and energized components per AC156, and analysis of the main force resisting members of the unit. Additional calculations shall be conducted to ensure components, accessories, and options remained intact and attached to the unit under seismic load conditions.

The certification shall be based on a maximum Design Structural Response Acceleration at Short Period (Sds) value of 1.85 g's for IBC 2006, 2009, 2012, 2015, 2018, 2021, and 2024 and 1.93 for IBC 2000 and 2003. This is obtained from the Maximum Considered Earthquake Short Period Spectral Response Acceleration, Ss, of 2.78 g's or 2.90 g's as determined by the ASCE 7 seismic maps for Soil Site Class B with 5 percent damping. When the site soil properties or final equipment installation location are not known, the soil site coefficient, Fa, defaults to the Soil Site Class D coefficient. Occupancy Category IV and Seismic Design Category C shall be covered under this certification, limited by the Sds value stated above. A seismic importance factor, Ip, of 1.5 shall apply to the certification to include essential facility requirements and life safety applications for post event functionality.

Structural floors, housekeeping pads, supporting curbs, and supporting steel must be seismically designed and approved by the project or building Structural Engineer of Record to withstand the seismic anchor loads. Installation details such as special inspection, attachment to a curb, or attachment to a non-building structure must be outlined and approved by the Engineer of Record for the project or building. The installing contractor shall be responsible for the proper installation of the equipment and must observe the seismic installation requirements set forth by the Engineer of Record.

Unit Construction

Casing Construction

All unit panels shall be 2-inch solid, double-wall construction to facilitate cleaning of unit interior. Unit panels shall be provided with a mid-span, no through metal, internal thermal break. Casing thermal performance shall be such that under 55°F supply air

temperature and design conditions on the exterior of the unit of 81°F dry bulb and 73°F wet bulb, condensation shall not form on the casing exterior.

All exterior and interior AHU panels will be made of G40 galvanized steel. Optionally, all interior AHU casing panels will be made of 201 stainless steel.

The casing shall be able to withstand up to 8-inches w.g. positive or negative static pressure. The casing shall not exceed 0.0042-inch deflection per inch of panel span at 1.5 times design static pressure up to a maximum of +8-inches w.g. in all positive pressure sections and -8-inches w.g. in all negative pressure sections.

Unit Flooring

The unit floor shall be of sufficient strength to support a 300-lb. load during maintenance activities and shall deflect no more than 0.0042-inch per inch of panel span.

Casing Leakage

The casing air leakage shall not exceed leak class 9 ($C_L = 9$) per ASHRAE 111 at 1.25 times maximum casing static pressure (P in inches w.g.), up to a maximum of +8-inches w.g. in all positive pressure sections and -8-inches w.g. in all negative pressure sections, where maximum casing leakage (cfm/100 ft² of casing surface area) = $C_L \times P^{0.65}$.

Optionally, the casing air leakage shall not exceed leak class 6 ($C_L = 6$) per ASHRAE 111 at 1.25 times maximum casing static pressure (P in inches w.g.), up to a maximum of +8-inches w.g. in all positive pressure sections and -8-inches w.g. in all negative pressure sections, where maximum casing leakage (cfm/100 ft² of casing surface area) = $C_L \times P^{0.65}$.

Insulation

Panel insulation shall provide a minimum thermal resistance (R) value of 13 ft²•h•°F/Btu throughout the entire unit. Insulation shall completely fill the panel cavities in all directions so that no voids exist and settling of insulation is prevented. Panel insulation shall comply with NFPA 90A.

Drain Pans

All cooling coil sections shall be provided with an insulated, double-wall, galvanized or stainless steel drain pan. To address indoor air quality (IAQ), the drain pan shall be designed in accordance with ASHRAE 62.1 being of sufficient size to collect all condensation produced from the coil and sloped in two planes promoting positive drainage to eliminate stagnant water conditions. The outlet shall be located at the lowest point of the pan and shall be sufficient diameter to preclude drain pan overflow under any normally expected operating condition. All drain pan threaded connections shall be visible external to the unit. Drain connections shall be of the same material as the primary drain pan and shall extend a minimum of 2 1/2 inches beyond the base to ensure adequate room for field piping of condensate drain traps. Coil support members inside the drain pan shall be of the same material as the drain pan and coil casing. Heating coil, access, and mixing sections may be provided with an optional IAQ drain pan.

Access Doors

Access doors shall be 2-inch double-wall construction. Interior and exterior door panels shall be of the same construction as the interior and exterior wall panels, respectively. All doors downstream of cooling coils shall be provided with a thermal break construction of door panel and door frame. Gasketing shall be provided around the full perimeter of the doors to prevent air leakage.

Surface-mounted handles shall be provided to allow quick access to the interior of the functional section and to prevent through-cabinet penetrations that could likely weaken the casing leakage and thermal performance. Handle hardware shall be designed to prevent unintended closure. Access doors shall be hinged and removable for quick, easy access. Hinges shall be interchangeable with the door handle hardware to allow for alternating door swing in the field to minimize access interference due to unforeseen job site obstructions. Door handle hardware shall be adjustable and visually indicate locking position of door latch external to the section.

All doors shall be a minimum of 60 inches high when sufficient height is available, or the maximum height allowed by the unit height.

Door handles will be provided for each latching point of the door necessary to maintain the specified air leakage integrity of the unit. Optionally, a single-handle door shall be provided for all outward swinging doors linked to multiple latching points necessary to maintain the specified air leakage integrity of the unit.



Mechanical Specifications

View Windows

An optional shatterproof window for viewing, capable of withstanding unit operating pressures, shall be provided in the door.

Marine Lights

A factory-mounted, weather-resistant (enclosed and gasketed to prevent water and dust intrusion), light emitting diode (LED) fixture shall be provided in sections of the unit as specified for maintenance and service visibility. Fixture shall be complete with aluminum die cast housing, polycarbonate lens designed for maximum light output, and LEDs wired to a single switch within a factory-provided service module. LED lighting shall provide instant-on white light and have a minimum 50,000 hour life. Fixtures shall be designed for flexible positioning during maintenance and service activities for optimal location.

All lights within the unit shall be wired to a single switch within the factory provided service module. The service module shall have an optional GFCI receptacle separate from the load side of the equipment. Electrical contractor shall be required to provide a 120V supply to the factory-mounted service module for the marine light circuit (unless single-point power is provided) and always for the GFCI receptacle circuit per NEC.

The service module shall be provided in the fan section, unless a controls section is provided. In which case, the service module will be provided in the controls section. The light switch is always on the supply fan.

Fans

The fan type shall be provided as required for stable operation and optimum energy efficiency. The fan shall be statically and dynamically balanced at the factory as a complete fan assembly. The fan shaft shall not exceed 75 percent of its first critical speed at any cataloged speed. Fan wheels shall be keyed to the fan shaft to prevent slipping. The fan shafts shall be solid steel. The fan section shall be provided with an access door on the drive side of the fan.

Direct-Drive Plenum Fan

The fan shall be a single-width, single-inlet plenum fan. The fan blades shall be aluminum backward-inclined airfoil. Plenum fan shall be direct-driven.

Fan sections containing multiple fans shall be controlled using a common control signal, such as the duct static control signal, to modulate the fan speed.

Direct Plenum Fan

Direct plenum fans provided with electronically commutated external- rotor motor with integrated control electronics, radial aluminum impeller with backward curved, continuously welded blades.

1. Individual Fan Assemblies shall be statically and dynamically balanced in two planes as per DIN / ISO 1940 to balancing grade G 6.3.
2. Fan-to-fan interaction can cause a significant increase in individual fan vibration when mounted to the same structure. Fans applied in an array shall be tested as a system and the total fan vibration shall be less than 0.42 (in/s) RMS including all fan-to-fan interaction. This system effect shall be accounted for by the air handler manufacturer. Individual fan vibration performance values shall not be acceptable.
3. Fan performance shall be rated in accordance with AHRI 430-2020. Fan shall be spaced to minimize aerodynamic fan interaction. Minimum center-to-center spacing between fans shall be 1.6 diameter ratio to ensure proper performance.
4. Fan wheels shall be constructed of materials that comply with UL 1995 requirements of flame and smoke spread per NFPA 90A. The flame spread index not exceeding 25 and a smoke-developed index not exceeding 50.
5. Fan Electrical Power (FEP) rated in accordance with AHRI 430-2020.
6. Motor shall contain integrated PID controller and accept a 0-10VDC input signal for variable speed control.
7. Motorized impeller fan section shall include expanded metal door guard(s) supplied on the access door(s) to the fan. Door guard is intended to deter unauthorized entry and incidental contact with rotating components.
8. Motor efficiency class shall comply with IE4.
9. Fan system manufacturer must stock replacement parts in North America.
10. Fan array shall be designed and constructed for easy field assembly and maintenance. Fan shall be assembled to bulkhead wall with minimal fasteners and the fan shall have quick disconnects for the high voltage and low voltage connections.
11. For units utilizing multiple fans in a fan section, a fan curve shall be provided showing the performance of the entire bank of fans at design conditions. In addition, a fan curve shall be provided showing the performance of each individual fan in the

bank of fans at design conditions. Also a fan curve shall be provided showing the performance of the bank of fans, if one fan is down. The percent redundancy of the bank of fans with one fan down shall be noted on the fan curve or in the tabulated fan data.

Fan Isolation

1-Inch, Seismic Spring Isolators

The fan and motor assembly (on sizes 3 to 8) shall be internally isolated from the unit casing with 1-inch (25.3-mm) deflection spring isolators, furnished and installed by the unit manufacturer. The isolation system shall be designed to resist loads produced by external forces, such as earthquakes, and conform to the current IBC seismic requirements.

2-Inch, Seismic Spring Isolators

The fan and motor assembly (on sizes 10 to 120) shall be internally isolated from the unit casing with 2-inch (50.8-mm) deflection spring isolators, furnished and installed by the unit manufacturer. The isolation system shall be designed to resist loads produced by external forces, such as earthquakes, and conform to the current IBC seismic requirements.

Fan Motors

The motor shall be integrally mounted to an isolated fan assembly furnished by the unit manufacturer. The motor shall be mounted inside the unit casing on an adjustable base to permit adjustment of drive-belt tension. The motor shall meet or exceed all NEMA Standards Publication MG1 requirements and comply with NEMA Premium efficiency levels when applicable. The motor shall have T-frame, squirrel cage with size, type, and electrical characteristics as shown on the equipment schedule.

- *Open Drip-Proof (ODP)*. The motor shall be open and drip-proof.
- *Totally Enclosed Fan-Cooled (TEFC)*. The motor shall be totally enclosed and fan-cooled.

Motor Options

- 200 volt, 3-phase, 60 Hz
- 230 volt, 3-phase, 60 Hz
- 460 volt, 3-phase, 60 Hz
- 575 volt, 3-phase, 60 Hz
- 115 volt, single-phase, 60 Hz
- 230 volt, single-phase, 60 Hz

Grease Lines

Bearings are selectable with life-time lubrication or with relubrication required. For any bearing requiring relubrication, the grease line shall be extended to the fan-support bracket on the drive side of the fan.

Fan Section Options

External Motor Junction Box

The fan section shall have motor leads extended to a factory-installed external junction box to facilitate motor wiring and to maintain air leakage integrity of the casing.

Motor Wiring Conduit

The fan motor wiring shall be factory-wired to the unit-mounted starter/disconnect, variable frequency drive (VFD), or external motor junction box within flexible metal conduit of adequate length so that the fan vibration isolation will not be restricted.

Flow Meter

The fan shall have an airflow measurement system to measure fan airflow directly or to measure differential pressure that can be used to calculate fan airflow. The system shall predict airflow within +/-5 percent total accuracy (device and transmitter) when operating within the stable operating region of the fan curve. The submitted fan airflow performance and noise levels shall not be affected by the installation of the device. Any device that provides an obstruction to the fan inlet will not be accepted.



Mechanical Specifications

Door Guard

On units supplied with plenum fans, expanded metal door guard(s) shall be supplied on the access door(s) to the fan, and those downstream access door(s) where unintended access to the plenum fan could occur. Door guard is intended to deter unauthorized entry and incidental contact with rotating components. See the Product Data section for fans with access door guard(s).

Overload Box

Overload panel is a factory mounted NEMA type 1 enclosure for indoor units, and NEMA type 4 enclosure for outdoor units. The panel will take one field VFD power input and distribute to 2 or 4 fans. These fans will be protected by manual motor protectors, one per fan. Auxiliary contacts are wired in series to terminal blocks for generic trip signaling. Panel is rated for WYE power systems up to 600V.

Backdraft Dampers

Each fan in the multiple-fan array shall be provided with integral back flow prevention: a backdraft damper that prohibits recirculation of air in the event a fan or multiple fans become disabled. Dampers are tested and rated based on AMCA Standard 500. Dampers to be heavy duty type capable of a maximum back pressure that exceeds the design total static pressure with minimal leakage. The dampers should have a minimal total effect on airflow performance—both pressure drop when open and system effect on the fan. The damper blades and frame shall be extruded aluminum with blade edge seals locked into the blade edge. Adhesive type seals are unacceptable. AHU manufacturer responsible for providing proper spacing upstream of dampers to ensure full, uniform airflow through upstream components. For units where the damper(s) are supplied at the jobsite, the installing contractor shall contract a certified TAB contractor to verify uniform airflow thru upstream components.

Fan Modulation

Variable-Frequency Drives (VFDs)

For variable-air-volume applications, airflow shall be modulated by a VFD that controls fan speed.

Inverter Test

Inverter test shall be performed to check vibration at unloaded conditions. Fan vibration levels shall be checked from 100 percent to 30 percent of required operating rpm.

Coils

Coils shall be manufactured by the supplier of the air handling unit and installed such that headers and return bends are enclosed by unit casing. Coils shall be removable by unbolting the wall panels in the coil section. Coil connections shall be clearly labeled on unit exterior. Fin surfaces shall be cleaned prior to installation in the unit to remove any oil or dirt that may have accumulated on the fin surfaces during manufacturing of the coil.

Horizontal and Vertical Coil Sections

The coil section shall be provided complete with coil and coil holding frame. Coil section side panels shall be easily removable to allow for removal and replacement of coils without impacting the structural integrity of the unit. The coils shall be installed such that headers and return bends are enclosed by unit casings. If two or more cooling coils are stacked in the unit, an intermediate drain pan shall be installed between each coil. Like the primary drain pan, the intermediate drain pan shall be designed being of sufficient size to collect all condensation produced from the coil and sloped to promote positive drainage to eliminate stagnant water conditions. The intermediate pan shall begin at the leading face of the water-producing device and be of sufficient length extending downstream to prevent condensate from passing through the air stream of the lower coil. Intermediate drain pan shall include downspouts to direct condensate to the primary drain pan. The outlet shall be located at the lowest point of the pan and shall be sufficient diameter to preclude drain pan overflow under any normally expected operating condition.

Inspection Section

The coil section shall include an inspection section complete with a double-wall, removable door downstream of the coil for inspection, cleaning, and maintenance. Interior and exterior door panels shall be of the same construction as the interior and exterior wall panels, respectively. All doors downstream of cooling coils shall be provided with a thermal break construction of door panel and door frame.

Water Coils

UW, UP, UU, UA, W, 5W, WD, 5D, D1, D2, P, 3U, 3W, 3P, or TT

The coils shall have aluminum fins and seamless copper tubes. Copper fins may be applied to coils with 5/8-inch tubes. Fins shall have collars drawn, belled, and firmly bonded to tubes by mechanical expansion of the tubes. The coil casing may be galvanized or stainless steel. The coils shall be proof-tested to 300 psig and leak-tested under water to 200 psig.

- Coil performance data and coils containing water or ethylene glycol shall be certified in accordance with AHRI Standard 410.
- Coils containing propylene glycol shall be rated in accordance with AHRI Standard 410.
- Calcium chloride, or mixtures thereof, are outside the scope of AHRI Standard 410, and therefore do not require AHRI 410 rating or certification.

Headers are to be constructed of round copper pipe or cast iron.

- Tubes shall be 3/8-inch OD, 0.012-inch copper.
- Tubes shall be 1/2-inch OD, 0.016-inch copper.
- Tubes shall be 1/2-inch OD, 0.025-inch copper.
- Tubes shall be 5/8-inch OD, 0.020-inch copper.
- Tubes shall be 5/8-inch OD, 0.024-inch copper.
- Tubes shall be 5/8-inch OD, 0.035-inch copper.
- Tubes shall be 5/8-inch OD, 0.049-inch red brass.

Hydronic coils may be supplied with factory installed drain and vent piping to unit casing exterior.

Refrigerant Cooling Coils

UF, FD, 3F

The coils shall have aluminum fins and seamless copper tubes. The fins shall have collars drawn, belled, and firmly bonded to tubes by mechanical expansion of the tubes. The coil casing may be galvanized or stainless steel. Suction and liquid line connections shall extend to the unit exterior.

Type UF and FD coils shall be proof-tested to 450 psig and leak-tested to 300 psig air pressure under water. Type 3F coils shall be proof-tested to 715 psig and leak-tested to 650 psig. After testing, the inside of the coils shall be dried, all connections shall be sealed, and the coil shall be shipped with a charge of dry nitrogen.

Suction headers shall be constructed of copper tubing with connections penetrating unit casings to permit sweat connections to refrigerant lines. The coils shall have equalizing vertical distributors sized according to the capacities of the coils. Coil performance data shall be certified in accordance with AHRI Standard 410.

- Tubes shall be 3/8-inch OD, 0.013-inch copper (internally enhanced only).
- Tubes shall be 1/2-inch OD, 0.016-inch copper (smooth or internally enhanced).
- Tubes shall be 1/2-inch OD, 0.025-inch copper (smooth only).

Steam Heating Coil

NS

The coils shall have aluminum fins and seamless copper tubes. Copper fins may be applied to coils with 1-inch tubes. The fins shall have collars drawn, belled, and firmly bonded to tubes by mechanical expansion of the tubes. The coil casing may be galvanized or stainless steel. Non-freeze, steam-distributing-type coils shall be provided. Steam coils shall be pitched in the unit for proper drainage of steam condensate from coils. The coils shall be proof-tested to 300 psig and leak-tested to 200 psig air pressure under water. Headers are to be constructed of cast iron. Inner tubes shall have orifices that ensure even steam distribution throughout the full length of the outer tube. Orifices shall be directed toward the return connections to ensure that the steam condensate is adequately removed from the coil. Coil performance data shall be certified in accordance with AHRI Standard 410.

- Tube construction shall be a 11/16-inch OD, 0.031-inch copper inner tube with a 1-inch OD, 0.031 copper outer tube.
- Tube construction shall be a 11/16-inch OD, 0.031-inch copper inner tube with a 1-inch OD, 0.049-inch red brass outer tube.



Mechanical Specifications

Coil Coating

The coil shall have a flexible epoxy polymer e-coat uniformly applied to all coil surface areas without material bridging between fins. Coating process shall ensure complete coil encapsulation and a uniform dry film thickness from 0.8 - 1.2 mil on all surface areas including fin edges. Superior hardness characteristics of 2H per ASTM D3363-92A and a cross-hatch adhesion of 4B-5B per ASTM B3359-93. Impact resistance shall be up to 160 in/lb. per ASTM D2794-93. Humidity and water immersion resistance shall be up to a minimum 1000 and 260 hours respectively (ASTM D2247-92 and ASTM D870-02). Corrosion durability shall be confirmed through testing to no less than 5,000 hours salt spray per ASTM B117-90 using scribed aluminum test coupons.

Electric Heat - Draw Through Coil Section

A UL-recognized electric heater shall be factory-installed in the air handler. The heater shall be an open-coil configuration with Type A wire (80% nickel and 20% chromium) derated to a maximum watt density of 45 watts per square inch. Safeties shall include three-pole, disconnecting-type contactors, airflow switches, automatic-reset functional limits, automatic-reset high-temperature limits, and manual-reset high-temperature limits. The contactors for energizing the electric heater shall be magnetic contactors. Electric heaters above 48 amps shall be fused into circuits not to exceed 48 amps as required by UL and NEC. Kilowatt output shall be selected to the nearest 0.1 kW of scheduled kilowatt.

Power options:

- 208 V, 3 ph
- 240 V, 3 ph
- 480 V, 3 ph
- 600 V, 3 ph

Control options:

- Basic External Relay Control
 - The electric heater shall use standard contactors with one side of the holding coil that may be connected to the thermostat or controller for staging purposes.
- Step Controller (0-10 VDC)
 - The electric heater shall be factory-wired to an electronic step controller relay bank. This type of control may be connected to a 0-10VDC or 4-20mA signal from a standalone thermostat or building automation system, which is converted to stages of heat.
- SSR-Full Modulating Control (0-10 VDC)
 - The electric heater shall be factory-wired to accommodate SSR-Full Modulating control. The SSR control can receive a 0-10VDC or 4-20mA signal from a standalone thermostat or building automation system providing full modulating control of the heater.
- SSR-Vernier Proportional Control (0-10 VDC)
 - The electric heater shall be factory-wired to accommodate SSR-Vernier control. The SSR control can receive a 0-10VDC or 4-20mA signal from a standalone thermostat or building automation system providing full modulating control of the first increment of heat. The staged increments are turned on and off by a step controller. As each stage is required to fulfill the demand for heat, the SSR increment is used as fully modulating between stages.

Electric Heat - Blow Through

The electric heater shall be factory-wired to accommodate SSR-Full Modulating control if the Heater is 96 amps or lower. The SSR control can receive a 0-10VDC signal from a standalone.

If the Heater is above 96 amps, then SSR-Vernier control is used. The SSR control can receive a 0-10VDC signal from a standalone thermostat or building automation system providing full modulating control of the first increment of heat. The staged increments are turned on and off by a step controller. As each stage is required to fulfill the demand for heat, the SSR increment is used as fully modulating between stages.

SSR-Full Modulating Control (0-10 VDC)

Electric Heat

A UL-recognized electric heater shall be factory-installed in the air handler. The electric heat is an open-wire resistance heater and installed in the reheat position. The heater has primary and secondary protection circuits. The contactors for energizing the electric heater shall be magnetic contactors. Electric heaters above 48 amps shall be fused into circuits not to exceed 48 amps as required by UL and NEC.

Integral Face-and-Bypass Coils

A section consisting of a horizontal or vertical-tube, integral face-and-bypass coil shall be provided. The coils shall be installed such that the headers and return bends are enclosed by the unit casings. The coils shall be sized as required to meet the scheduled capacity using steam or hot water, as specified. The integral face-and-bypass coils shall consist of a built-in series of finned heating elements and bypasses with interlocked dampers. Coil performance shall be certified in accordance with ARI Standard 410. Integral face-and-bypass coils shall be provided with a factory-mounted damper actuator when specified.

Dampers

Damper Performance and Operating Conditions

The operating temperature range is -40°F to 200°F . Manufacturer must be able to demonstrate structural capacity of damper to withstand maximum system air velocity of 3,000 fpm when fully open. Manufacturer must be able to demonstrate structural capacity of damper to withstand maximum system back pressure of 6 inches w.g. in the closed position. Pressure drop shall be maximum 0.1 inch w.g. at 1,000 fpm across a fully open 24 inch x 24 inch damper. Damper pressure drop ratings shall be in accordance with Air Movement and Control Association (AMCA) 500.

Dimensions and Tolerances - In addition to the dimensions and tolerances shown on the applicable drawing, the following dimension tolerance criteria must be met:

- Mounting flange slot tolerance: $-0/+0.031$
- All sheet metal brake angles: ± 3 degrees
- Overall frame size: $+0/-0.125$
- Mounting flange flatness:
- Overall dimension 48 inches and under: 0.062:/ft
- Over 48 inches: within 0.25 inch overall
- Frame squareness*: ± 0.125 inch diagonal corner to corner

*Squareness is defined as the difference between two diagonal measurements.

Packing and Shipping - Dampers shall be prepared for shipment in accordance with commercial practice to assure carrier acceptance and safe transportation to the point of delivery. Packaging shall conform to carrier rules and regulations applicable to the mode of transportation.

Energy Recovery Wheel Section

The air-handling unit shall have a total energy recovery wheel sized per the ventilation requirement of the unit. Mixed air units with economizing shall be constructed with internal bypass dampers such that the pressure drop across the wheel does not increase during economizing.

Performance and Certification

The energy recovery wheel shall be ARI 1060-certified. The air-handling unit nameplate shall bear the ARI 1060 certification label. The energy recovery cassette shall be an Underwriters Laboratories (UL) Recognized Component certified for mechanical, electrical, and fire safety in accordance with UL Standard 1812. The calculated total net effectiveness of the recovery device shall be not less than 70 percent when the specified ventilation flow rate equals the exhaust flow rate.

Wheel Construction

The energy recovery wheel cassette shall incorporate a rotary wheel with all necessary seals, drive motor, and drive belts. The total energy recovery wheel shall incorporate a desiccant without the use of binders or adhesives. Coated segments shall be washable using standard detergent or alkaline-based coil cleaners. The desiccant shall not dissolve in the presence of water or high humidity. The rim shall be of continuous rolled stainless steel and forms an even concentric circle, preventing leakage around the rim and minimizing the wear of components. All diameter and perimeter seals shall be provided as part of the cassette assembly. Perimeter seals shall be self-adjusting; diameter seals are adjustable. Seals shall be factory set. Wheel bearings shall be permanently sealed and lubricated and have a minimum L-10 life of 400,000 hours.

Wheel Motor

The wheel drive motor shall be mounted in the cassette frame. The wheel drive motor shall be thermally protected and UL Component Recognized. Drive belts shall not require belt tensioners.



Mechanical Specifications

Maintenance and Access

Energy recovery wheel shall be provided in the form of removable segments. The segments shall be removable without the use of tools to facilitate maintenance and cleaning as required. The cassette shall be removable through the energy recovery section side panel. Access doors shall be provided immediately upstream and downstream of the energy recovery wheel cassette. Adequate space shall be provided for cleaning, service, and maintenance of the wheel, motor, bearing, and belt.

Wheel Control

The energy recovery wheel section shall incorporate a variable effectiveness damper to control the energy wheel recovery capacity. The variable effectiveness control shall have the ability to modulate the total energy recovery effectiveness to 40 percent of the initial total recovery capacity. Variable frequency speed control is not an acceptable method for controlling capacity.

Frost Control

Frost control prevention shall be achieved by either outside air bypass, or return air preheat. Frost setpoint temperatures based on scheduled design air conditions shall be provided by the air handling manufacturer. Winter design supply and exhaust air conditions leaving the energy wheel provided by the unit manufacturer shall include any derate in performance due to frost protection measures.

Wheel Warranty

In conjunction with the air handler manufacturer's standard unit warranty, the energy recovery wheel shall be warranted for a period of five years. Warranty applies to all parts and components of the energy recovery cassette with the exception of the motor.

Cool Dry Quiet (CDQ™) Desiccant Wheel

The air handling unit shall be provided with a CDQ desiccant wheel to control space humidity based on specified requirements. The wheel media shall meet the flammability requirements governing this class of products and shall be a UL-recognized component in accordance with UL 1812 and UL1995.

Wheel Construction

The CDQ desiccant wheel shall be constructed of a synthetic matrix with a type III desiccant. The wheel shall be structurally reinforced with a spoke system to minimize wheel deflection. All diameter and perimeter seals shall be provided as part of the cassette assembly. The drive system shall consist of a heavy-duty fractional horsepower A/C gear motor mounted in the cassette.

CDQ Wheel Drive System

The motor shall have permanently lubricated bearings. The bearings, which support rotation of the wheel around a center shaft, shall be provided with grease fittings for periodic lubrication.

Maintenance and Access Doors

The wheel matrix shall be cleanable. The desiccant shall not dissolve in the presence of water or high humidity. Access doors shall be provided immediately upstream and downstream of the CDQ wheel cassette. Adequate space shall be provided for cleaning, service, and maintenance of the wheel, motor, bearing, and belt.

Humidifiers

Direct Steam

Humidifier section shall be provided with a humidifier panel designed for building steam. Humidifier panel shall include stainless steel construction of all wetted parts including the integrated header/separator and multiple tube dispersion assembly. Tube-to-header joints shall consist of welded stainless steel. Humidifier shall provide a uniform steam discharge. Humidifiers shall be provided with a control valve, inverted bucket steam trap, wye strainer, and two float and thermostatic steam traps shipped loose for field installation. All pipe connections shall be made from one side of the air handler.

Atmospheric Steam

Humidifier section shall be provided with a humidifier panel designed for atmospheric steam. Humidifier panel shall include stainless steel construction of all wetted parts including the header/separator and multiple tube dispersion assembly. Tube-to-header joints shall consist of welded stainless steel. Humidifier shall provide a uniform steam discharge. All pipe connections shall be made from one side of the air handler.

Filters and Air Cleaners

Filter sections shall have filter racks, at least one access door for filter removal, and filter block-offs to prevent air bypass around filters. The filter sections shall be supplied with 2-inch or 4-inch flat, or 2-inch or 4-inch angled, bag, or cartridge filters.

Permanent Filters

The filters shall be 2-inch, all-metal, viscous-imprisonment type, capable of operating up to 625-fpm face velocity without loss of filter efficiency and holding capacity. The filter media shall be layers of cleanable wire mesh. The filter frame shall be constructed of galvanized steel. The filters shall have a MERV 2 rating when tested in accordance with the ANSI/ASHRAE Standard 52.2.

Throwaway Filters

The filters shall be throwaway-type and shall have 2-inch fiberglass media contained in a rigid frame. Filters shall be capable of operating up to 500-fpm face velocity without loss of filter efficiency and holding capacity. Filters shall have a rigid supporting mesh across the leaving face of the media. The filters shall have a MERV 5 rating when tested in accordance with the ANSI/ASHRAE Standard 52.2.

Pleated Media Filters

The filters shall be 2-inch or 4 inch, made with 100 percent synthetic fibers that are continuously laminated to a supported steel-wire grid with water repellent adhesive. Filters shall be capable of operating up to 625-fpm face velocity without loss of filter efficiency and holding capacity. The filters shall have a MERV 8 rating when tested in accordance with the ANSI/ASHRAE Standard 52.2.

Bag Filters

The filters shall be triple-layer of high-loft 100% synthetic media. The pocket sealing method shall permit the bag to retain its pleated shape without the use of a wire-basket support. The filters shall be capable of operating up to 625 fpm face velocity without loss of filter efficiency and holding capacity. The filters shall be sealed into a metal header. A gasket material shall be installed on the metal header of the filter to prevent filter bypass where the metal headers meet the side-access racks. All bag filters shall be furnished with a 2-inch prefilter to extend bag filter life. The manufacturer shall supply a side-access filter rack capable of holding bag filters and prefilters.

The bag filters shall have a MERV 12 rating when tested in accordance with the ANSI/ASHRAE Standard 52.2.

Cartridge Filters

The filters shall be 12-inch cartridge filters constructed with a continuous sheet of fine-fiber media made into uniformly spaced pleats. The filters shall be capable of operating up to 625 fpm face velocity without loss of filter efficiency and holding capacity. The filters shall be sealed into a metal frame assembled in a rigid manner. A gasket material shall be installed on the metal header of the filter to prevent filter bypass where the metal headers meet on the side-access racks. All cartridge filters shall be furnished with a 2-inch prefilter to provide extended cartridge filter life. The manufacturer shall supply a side-access filter rack capable of holding cartridge filters and prefilters. The cartridge filters shall have a MERV 15 rating when tested in accordance with the ANSI/ASHRAE Standard 52.2.

4-Inch High-Efficiency Filters

The filters shall be constructed with a fine fiber media made into closely spaced pleats. The filters shall be capable of operating up to 625-fpm face velocity without loss of filter efficiency and holding capacity. The filter media shall be sealed into a frame assembled in a rigid manner. All 4-inch high-efficiency filters shall be furnished with a 2-inch prefilter to provide extended filter life. The manufacturer shall supply a side-access filter rack capable of holding 4-inch high-efficiency filters and prefilters. The filters shall have a MERV 11 to 15 rating when tested in accordance with the ANSI/ASHRAE Standard 52.2.

HEPA Filters

The HEPA filter cells shall be enclosed in a galvanized steel frame with neoprene rubber applied to the leaving-air side of the filter cell to reduce air leakage. Continuously welded, front-load filter frames with filter holding clips shall be mounted inside the



Mechanical Specifications

section casing and shall be gasketed to prevent leakage or air bypass. Filter clips shall require tooling in order to tighten and hold filter cells to frame. Filter media shall be produced from glass waterproof microfiber with a continuous pleat and aluminum separates between pleat folds. Filters shall be capable of operating up to 500-fpm face velocity without loss of filter efficiency and holding capacity. HEPA filter efficiency shall be not less than 99.97 percent when tested in accordance with ASHRAE 52.1 atmospheric dust spot method. Although not covered by MERV ratings, HEPA filters shall be not less than an equivalent 17 when tested in accordance with ASHRAE 52.2.

Air Cleaning Systems

Trane Commercial Air Purification System (TCAPS)

The Trane Commercial Air Purification System (TCAPS) shall be factory-engineered and factory-installed as a two-part integral assembly for treatment of air by:

- High Efficiency Particle Filtration
- Graphene Enhanced Photocatalytic Oxidation (GPCO)
- Catalyst media using titanium dioxide (TiO₂)

High efficiency particle filters are recommended to be rated MERV 13 or higher. Filters are positioned immediately upstream of the GPCO media.

UV-A Light Emitting Diodes (LEDs) are designed specifically to provide type-A ultraviolet light with a wavelength at or near 395 nm and shall not produce any ozone. LEDs shall be built into the air purification assembly and will provide UVA light across all exposed surfaces of the GPCO media. The catalyst media shall consist of an 8 mm deep (direction of airflow) honeycomb grid, with face area to match casing opening. The complete LED/GPCO media bank assemblies shall be housed in a galvanized or stainless-steel casing and placed in the air handler perpendicular to the airflow.

LED/GPCO media banks (modules) are provided in four sizes. Multiple modules are used as required to cover the entire airstream. All UV lamps and PCO media shall be removable from outside the AHU casing through a side access door for maintenance purposes.

Power options:

- 120V/1 phase/60hz
- 200-208V/1ph/60hz
- 230V/1ph/60hz
- 460V/1ph/60hz
- 575V/1ph/60hz

All systems shall have a single point external power connection independent of AHU power. All necessary main fusing shall be included.

Electrical fixtures shall meet the UL drip proof design criteria. Component enclosures shall be constructed of galvanized steel or stainless steel to resist corrosion. Fixtures shall have been tested and recognized by UL/C-UL under Category Code ABQK (Accessories, Air Duct Mounted), UL Standards 1995/60335. The TCAPS shall be provided with a UL 508 listed panel for power distribution and over-current protection.

TCAPS assembly shall be capable of withstanding 750 fpm face velocity with no structural damage.

Access doors shall be provided at the location of each Trane Commercial Air Purification System as indicated on the plans and schedule. All doors with line of sight to TCAPS shall have safety interlock switches that disable power upon opening. Each TCAPS shall be equipped with an externally mounted electrical disconnect switch, with lock-out capability to prevent unwanted operation for maintenance purposes. A view port window shall be provided on each air handler to allow visual inspection of the Trane Commercial Air Purification System during operation. Complete safety, maintenance and servicing instructions for the Trane Commercial Air Purification System shall be incorporated into the air handler manufacturer's standard installation, operating and maintenance manuals.

Filter Section Options

Differential Pressure Gauge

A differential pressure gauge shall be flush-mounted with casing outer wall with probes piped to both sides of the filter bank to indicate status. Combination filter frames will be provided with a separate differential pressure gauge piped across each of the high-efficient and pre-filter banks. The gauge shall be diaphragm-actuated dial-type and shall maintain a +/- 5 percent accuracy within operating temperature limits of the air handler. Range shall be 0 - 2.0 in. w.g.

HEPA Filter Differential Pressure Gauge

A differential pressure gauge shall be mounted externally on the unit casing outer wall with probes piped to both sides of the HEPA filter bank to indicate status. The gauge shall be diaphragm-actuated dial-type and shall maintain a +/- 5 percent accuracy within operating temperature limits of the air handler. Range shall be 0 - 5.0 in. w.g.

Front-Loading Filter Differential Pressure Gauge

A differential pressure gauge shall be mounted externally on the unit casing outer wall with probes piped to both sides of the filter bank to indicate status. The gauge shall be diaphragm-actuated dial-type and shall maintain a +/- 5 percent accuracy within operating temperature limits of the air handler. Range shall be 0 - 2.0 in. w.g.

Mixing Section

A functional section shall be provided to support the damper assembly for outdoor, return, and/or exhaust air.

Dampers

Dampers shall modulate the volume of outdoor, return, or exhaust air. The dampers shall be of double-skin airfoil design with metal, compressible jamb seals and extruded-vinyl blade-edge seals on all blades. The blades shall rotate on stainless-steel sleeve bearings. Airfoil dampers shall be rated for a maximum leakage rate of 3 cfm/ft² at 1 in. w.g. complying with ASHRAE 90.1 maximum damper leakage. All leakage testing and pressure ratings shall be based on AMCA Standard 500-D. Dampers may be arranged in a parallel or opposed-blade configuration.

Airflow Measurement Station (Standard Traq Dampers)

A factory-mounted airflow measurement station tested in accordance with AMCA Standard 611 and bearing the AMCA Ratings Seal for Airflow Measurement Performance shall be provided in the outdoor and/or return air opening to measure airflow. The damper blades shall be galvanized steel, housed in a galvanized steel frame and mechanically fastened to a rotating axle rod. The dampers shall be rated for a maximum leakage rate of 3 cfm/ft² at 1 in. w.g. complying with ASHRAE 90.1 maximum damper leakage. The standard airflow measurement station shall be capable of measuring from 15 percent to 100 percent of unit nominal airflow. The airflow measurement station shall adjust for temperature variations and provide a 2 to 10 Vdc signal that corresponds to actual airflow for controlling and documenting airflow. The accuracy of the airflow measurement station shall be ±5 percent.

Airflow Measurement Station (Low-Flow Traq Dampers)

A factory-mounted airflow measurement station tested in accordance with AMCA Standard 611 and bearing the AMCA Ratings Seal for Airflow Measurement Performance shall be provided in the outdoor and/or return air opening to measure airflow. The damper blades shall be galvanized steel, housed in a galvanized steel frame and mechanically fastened to a rotating axle rod. The dampers shall be rated for a maximum leakage rate of 3 cfm/ft² at 1 in. w.g. complying with ASHRAE 90.1 maximum damper leakage. The low-flow airflow measurement station shall be capable of measuring down to 7.5 percent of unit nominal airflow. The airflow measurement station shall adjust for temperature variations and provide a 2 to 10 Vdc signal that corresponds to actual airflow for controlling and documenting airflow. The accuracy of the airflow measurement station shall be ±5 percent.

Internal Face-and-Bypass Damper Section

Dampers shall be provided as scheduled to divert airflow around the coil. Dampers shall be of double-skin airfoil design with metal, compressible jamb seals and extruded-vinyl blade-edge seals on all blades. The blades shall rotate on stainless-steel sleeve bearings. Dampers are arranged in an opposed-blade configuration and mechanically linked with jackshafts. The dampers shall be rated for a maximum leakage rate of 5 cfm/ft² at 1 in. w.g. All leakage testing and pressure ratings shall be based on AMCA Standard 500-D.

Drum and Tube Gas Heat

Indirect-fired gas heaters shall be completely factory assembled, piped, and operationally fire tested at the factory prior to shipment. The heat exchanger primary drum and secondary tubes shall be constructed from 14-gauge, 409 stainless steel. The industrial/commercial burner shall be UL listed, forced draft, and fully modulating. The control panel shall be equipped with appropriate flame management controls and safeties. The gas heat section construction shall match the rest of the air handling unit and be an integral part of the unit. All burner and control components shall be housed in a burner vestibule with a large access door. The entire section shall bear a UL or CUL label for Commercial-Industrial Gas Heating Equipment (ANSI / UL Standard 795) and Industrial Gas-Fired Package Furnaces (CGA Standard 3.2-1976).



Mechanical Specifications

Inshot Gas Heat

Indirect fired gas heaters shall be completely assembled and operationally fire tested at the factory prior to shipment. The heat exchanger tubes shall be constructed from 409 stainless steel. The furnace heat module shall be UL listed, induced draft, and fully modulating. The gas heat section construction shall match the rest of the air handling unit and be an integral part of the unit. All burner and control components shall be housed in a burner vestibule with a access door. The entire section shall bear a UL or CUL label for Commercial-Industrial Gas Heating Equipment (ANSI / UL Standard 795) and furnaces certified to ANSI Z83.8 Gas-fired Duct Furnace and Z2147 Gas-Fired Furnace Standards.

Air-to-Air Plate Frame Heat Exchanger

Construction

Air-to-air, fixed-plate heat exchangers shall be provided as indicated on the schedule and drawings. Exchangers shall be a cross flow, plate-type with no moving parts or secondary heat transfer surfaces. Plates shall be a minimum 99.5% aluminum and formed with a plate profile for maximum efficiency and cleanability, and minimizes pressure loss. The connecting plate edges shall be double-folded and internally sealed with a silicone free elastic resin to minimize leakage. The corners of assembled exchanger packages shall also be sealed to minimize leakage. The connecting plate edges shall be double-folded and internally sealed with a silicone free elastic resin to minimize leakage. The corners of assembled exchanger packages shall also be sealed to minimize leakage. Heat exchanger assemblies shall be able to withstand temperatures of 212F. Access to all four faces of exchangers shall be provided for cleaning and inspection. Drain pans shall be provided under each the supply and exhaust sides of the exchanger, with drain connections extending to the exterior of the unit base. Drain pans shall be either galvanized or stainless steel of the same construction as provided in other unit sections.

Performance

The heat exchanger shall be certified to ANSI/AHRI Standard 1060 and bear the AHRI 1060 label. Performance characteristics of the heat exchanger shall be provided as defined by AHRI 1060 definitions. The heat exchangers EATR shall be less than 1% as shown by AHRI certification. Heat exchanger face velocity shall not exceed 500fpm and not exceed specified pressure drop. Performance shall match or exceed specified effectiveness. Condensate volume at design conditions shall be predicted by the air handling unit manufacturer.

Corrosion Coating (Optional)

To provide protection for installations in mildly corrosive environments the air-to-air plate exchanger plates shall have an Epoxy-phenol lacquer applied coating. The extrusions, end plates and all sheet metal surfaces of the plate exchanger are to be epoxy coated.

Frost Damper (Optional)

Heat exchangers shall meet the leaving air temperature (LAT) as shown on the schedule while operating at the specified conditions and while operating in frost prevention mode. Frost prevention systems shall provide continuous output temperatures. Defrost systems with temperature swings due to defrost cycles will not be acceptable. Frost systems shall incorporate a partial face damper factory installed on the outside air side of the exchanger.

Bypass Dampers (Optional)

Opposed blade face and bypass dampers shall be provided as indicated on the schedule and drawings to modulate the plate exchanger effectiveness. Dampers shall have the same construction as the double-skin airfoil design specified in mixing sections. Bypass shall be through the center of the exchanger and shall be capable of 100% bypass. Static pressure drop through the bypass shall be calculated at the maximum economizing airflow and shall not exceed the schedule values.

Paint Options

Outdoor Unit Paint

External surface of unit casing shall be prepared and coated with a minimum 1.5 mil enamel finish or equal. Units supplied with casing exterior factory-painted shall be able to withstand a salt spray test in accordance with ASTM B117 for a minimum of 500 consecutive hours. Unit casing exterior will be provided with manufacturer's standard color, or alternative color when required.

Optional Indoor Unit Paint

In indoor units all exterior AHU panels will be made of galvanized steel. As an option, the external surface of the unit casing can be painted upon request. Units supplied with factory-painted exterior casing shall be able to withstand a salt spray test in accordance with ASTM B117 for a minimum of 500 consecutive hours. Unit casing exterior will be provided with manufacturer's standard color, or alternative color when required.

Pipe Cabinet

For outdoor units, piping cabinet shall be supplied by the manufacturer (factory-assembled) and shall be of the same construction as the main unit casing. Piping cabinet shall be mounted external to the unit and shipped separate to be field-installed.

Outdoor Unit Roof

Trane engineered inner roofs incorporate mid-span, internal thermal breaks to eliminate thermal conduction paths from the interior of the air handler to the exterior (2-inch R13 foam-insulated). Inner/ Indoor/ roof will be installed in such a manner as to prevent air bypass between internal components. A single layer Outer/Outdoor roof is utilized above the inner roof and will be sloped at a minimum 0.125 inches per foot either from one side of unit to other, or from center to sides of the unit. Roof assembly will overhang all walls of units by a 1.5-inch minimum.

Silencers

A rectangular silencer shall be provided to reduce airborne sound transmitted through the air handler. The silencer ratings for dynamic insertion loss and pressure drop shall be in accordance with ASTM E-477 for forward flow (air and noise in the same direction) or reverse flow (air and noise in the opposite direction) per the project's requirements. Acoustical performance within the air handler unit assembly shall be in accordance with AHRI 260.

Other Sections and Options

Access/Inspection Sections

A section shall be provided to allow additional access/inspection of unit components and space for field-installed components as needed. The section length shall be variable to accommodate specific access, spacing, or dimensional requirements. An access door shall be provided for easy access. All access sections shall be complete with a double-wall, removable door downstream for inspection, cleaning, and maintenance. Interior and exterior door panels shall be of the same construction as the interior and exterior wall panels, respectively. All doors downstream of cooling coils shall be provided with a thermal break construction of door panel and door frame.

Blender Section

An air blender section shall be provided to mix outside and return air, minimize stratification, and reduce the risk of frozen coils. The blender size, space upstream, and space downstream shall be factory engineered for proper performance.

Diffuser Section

A diffuser section shall be provided immediately downstream of the fan section. The diffuser shall provide equal air distribution to blow-thru components immediately downstream of the diffuser.

Turning and Discharge Plenum Sections

Plenums shall be provided to efficiently turn air and provide sound attenuation. Discharge plenum opening types and sizes shall be scaled to meet engineering requirements. The vertical discharge plenum height may be scaled to accommodate the appropriate discharge duct height. The horizontal discharge plenum length may be scaled to accommodate necessary dimensional constraints.

Plenum Attenuation Panels

Discharge plenum panels shall include an acoustical liner. The liner shall be fabricated from stainless steel perforated material to prevent corrosion and designed to completely encapsulate fiberglass insulation. The perforation spacing and hole size shall be such as to prevent insulation breakaway, flake off, or delamination when tested at 9,000 fpm, in accordance with UL Specification 181.



Controls

Combination Starter–Disconnects

An IEC combination starter/disconnect shall be provided for each fan motor. Each starter / disconnect shall be properly sized, factory mounted in a full metal enclosure, and wired to the fan motor to facilitate temporary heating, cooling, ventilation, and/or timely completion of the project. Starter/disconnects shall include a circuit breaker disconnect with a through-the-door interlocking handle, spring-loaded and designed to rest only in the full ON or OFF state and shall be lockable in these states. A concealed defeater mechanism shall allow entry into the enclosure when the handle is in the ON position. The starter package shall also include:

- Hand-Off-Auto (H-O-A) selector switch
- Two N.O. auxiliary contacts
- Overload heaters
- Manual reset overloads
- 120V control transformer with fusing and secondary grounding

Units with factory-mounted controls shall also include power wiring from the starter control transformer to the secondary control system transformers, and start-stop wiring from the direct digital controller start-stop relay to the starter H-O-A switch.

Combination VFD and Disconnects

A combination VFD/disconnect shall be provided for each fan motor. Each VFD/disconnect shall be properly sized, factory mounted in a full metal enclosure, wired to the fan motor, and commissioned to facilitate temporary heating, cooling, ventilation, and/or timely completion of the project. VFD/disconnects shall include a circuit breaker disconnect with a through-the-door interlocking handle designed to rest only in the full ON or OFF state and shall be lockable in these states. A concealed defeater mechanism shall allow entry into the enclosure when the handle is in the ON position. The VFD package shall also include:

- Electronic manual speed control
- Hand-Off-Auto (H-O-A) selector switch
- Inlet fuses to provide maximum protection against inlet short circuit
- Current limited stall prevention
- Auto restart after momentary power loss
- Speed search for starting into rotating motor
- Anti-windmill with DC injection before start
- Phase-to-phase short circuit protection
- Ground fault protection

Units with factory-mounted controls shall include a control transformer with sufficient capacity to support both the VFD and controls requirements, binary output on/off wiring, analog output-speed-signal wiring, and all interfacing wiring between the VFD and the direct digital controller.

The VFD shall be UL508C listed and CSA certified and conform to applicable NEMA, ICS, NFPA, and IEC standards.

Optional Bypass (Housed fans only)

Bypass relays and bypass circuitry with a VFD/OFF/Bypass selector switch shall be provided.

Starter/Disconnect or VFD Enclosure Options

Starter or VFD shall be mounted externally on the fan section in a NEMA Type 1 enclosure (unit sizes 3-120) or internally in a NEMA Type 4 equivalent unit casing (unit sizes 3-120) within a dedicated controls section or housed fan section. The internal enclosure shall be an integral part of the unit casing to allow for thermal venting to casing interior, but shall be accessible from unit exterior through access door. Internally mounted starters/VFDs shall have doors with the same construction as other doors on unit. An external disconnect shall be mounted through the access door to the starter or VFD to disconnect full power from starter/VFD, lights, or control power.

Digital Terminal Block System

Unit control points are wired to a factory installed interface for a field-supplied controller. All control points are factory tested prior to shipment. All factory-installed end devices are wired and terminated to unit expansion modules that communicate to the DDC controller with a communication bus. The end device point names and dimensionality are set in the DDC controller, and communicate to third-party systems with BACnet® integration. No Trane programming logic is installed in the DDC controller.

Factory-Mounted DDC System

Factory-mounted direct-digital control (DDC) system shall be engineered, mounted, wired, programmed, and tested by the air handler manufacturer to reduce installed costs, improve reliability, and save time at unit startup. Each control system shall be fully functional in a stand-alone mode or may be tied to a building automation system with a single pair of twisted wires. All factory-mounted controls shall be covered by the air handler manufacturer's standard warranty.

Direct Digital Controller

Field-Programmable Controller

A dedicated, programmable, direct digital-controller with the appropriate point capabilities shall be unit-mounted on each air-handling unit. A portable screen and keypad shall be provided to facilitate local monitoring, troubleshooting, and changing of setpoints. The touch pad shall be able to quickly plug into other factory-configured controllers by the same manufacturer.

Factory-Mounted Control Options—Electronic End Devices

All factory-mounted control devices shall be provided to accommodate integration into existing building systems. Devices provided shall be wired to standard point locations of a unit-mounted direct digital controller or terminal block for a remote controller.

Mixing Section Damper Actuators

Spring return actuators shall be mounted with the outdoor air damper linked as normally closed and the return-air damper linked as normally open.

Airflow Measuring Stations (TraQ Dampers)

Airflow monitoring stations shall provide a 2 to 10 Vdc signal, which corresponds to cfm, for controlling and documenting airflow.

Temperature Sensors

Unit-mounted temperature sensor material shall be selected for ease of integration into existing BAS control systems.

Temperature sensor material type include 10k ohm, Type II Thermistor.

Fan Discharge Temperature Sensors

A button or probe temperature sensor shall be mounted in the fan discharge. The sensor material shall be selected for ease of BAS integration.

Averaging Temperature Sensors

An averaging temperature sensor shall be serpentine across the functional section. Bends of the capillaries shall be curved and fastened with capillary clips to prevent crimping and minimize wear. The sensor material shall be selected for ease of BAS integration.

Low-Limit Switches

A double-pole low limit switch shall be wired to a momentary push-button reset circuit. Capillaries are serpentine across the entering side of the coil. The bends of the capillaries shall be curved and fastened with capillary clips to prevent crimping and minimize wear. A separate low limit shall be provided for each coil in a coil stack.

Airflow Switches

A differential pressure switch piped to the discharge and suction sides of the fan shall indicate fan status.

Dirty Filter Switches

A differential pressure switch piped to both sides of the filter shall indicate filter status.

Condensate Overflow Switches

A float switch conforming to UL 508 shall be factory-installed in the drain pan that will detect a high condensate water level and be used to shut off the air handler in the event that the primary drain is blocked to comply with IMC 2006. The float switch shall be located at a point higher than the primary drain line connection and below the overflow rim of the drain pan.

End Devices

- Air-Fi
- Current sensor
- Filter transducer
- High/low pressure cut outs

Customer Interface Relays



Mechanical Specifications

Five-amp double-pole, double-throw relays shall be provided as required for each binary output of the controller for customer interface to:

- Motor starters of supply, return, and exhaust fans
- Relief dampers
- Pumps
- Condensing units

Field-Mounted Control Options

Control Valves

Control valves shall be provided by the air-handling unit (AHU) manufacturer and field-piped by the piping contractor. Power and signal wiring shall be extended to a factory-installed external junction box to facilitate field-wiring and to maintain air leakage integrity of the casing.

Space Temperature Sensors

Thermistor-type sensors shall be provided by the air-handling unit (AHU) manufacturer as required for field wiring.

Outdoor Air Sensors

Thermistor-type sensors shall be provided by the air-handling unit (AHU) manufacturer as required for field wiring.

Ultraviolet (UV-C) Lights

UV-C light fixtures and lamps shall be provided by the air handler manufacturer. The UV-C fixtures shall be factory-assembled and tested in the air handler. Field-installed fixtures shall not be allowed.

Design of the UV-C light array shall assure that the UV-C energy striking the intended coil and drain pan surfaces shall have an average intensity on the surface plane of the coil not less than 550 microwatts per square centimeter and provide not less than 99 percent surface disinfection efficiency. The minimum intensity at any point on the surface plane of the coil must exceed 100 microwatts per square centimeter. Energy consumption at the design intensity shall be no more than 10 watts for each square foot of treated, cross sectional plane.

Lamps and Fixtures

- Lamps shall be installed in sufficient quantity and in such a manner so as to provide an equal distribution of UV-C energy. The UV-C energy produced shall be of the lowest possible reflected and shadowed-losses and shall provide 360 degree UV-C irradiance within the UV cavity. The lamps shall not produce ozone.
- Each lamp shall be high-output, hot cathode, T5 diameter, medium bi-pin type that produces UVC energy at 254 nanometers. Lamps shall contain no more than 5 milligrams of mercury and produce the specified UV-C output when installed in air of up to 600 fpm velocity and temperatures of 50-135 degrees F. Lamp life shall be 9,000 hours minimum with no more than a 15 percent loss of output after one year of use.
- The power supply housing shall be capable of installation within the air stream. Lamps shall be mounted to irradiate the intended surfaces as well as all of the available line of sight airstream from proper placement, 360° irradiation and incident angle reflection.
- Fixtures shall meet the UL drip-proof design criteria and be constructed to resist corrosion. Fixtures shall have been independently tested and recognized by UL/C-UL under Category ABQK (Accessories, Air Duct Mounted), UL Standards 153, 1598 and 1995. Ballast enclosure and lamp support angles shall be constructed of galvanized steel.

Protection of Polymeric Materials

All polymeric materials in direct or indirect (reflected) contact with UV-C energy shall be tested and certified as UV-C tolerant. Polymeric materials not certified as UV-C tolerant shall be completely shielded from the UV-C light using a certified UV-C tolerant material such as metal. UV-C tolerance is defined as being capable of performing its intended duty for a minimum of 20 years.

Safety

- Access doors shall be provided at the location of each UV-C light as indicated on the plans and schedule. All sections of the air handler with access doors where the UV-C lights may pose a risk for direct exposure shall have a mechanical interlock switch that disconnects power to the lights when the door is opened.

- In addition to the mechanical interlock switch, each unit shall be equipped with an externally mounted on-off/disconnect/shut off switch that disconnects power to the UV-C lights. The switch shall be equipped with a lock-out/tag-out to prevent unwanted operation of the UV- C lights.
- A view port shall be provided in or adjacent to each UV section to allow viewing of the UV-C light array confirming operation. The view port and other AHU windows shall be treated to assure the UV-C energy emitted through it is below the threshold limits specified by NIOSH and ACGIH.
- Units shall have a safety warning label applied to the exterior of each section containing UV-C lights.
- Complete safety, maintenance and servicing instructions for the UV-C lights and fixtures shall be incorporated into the air handler manufacturer's standard installation, operating and maintenance manuals.

Leak Detection Sensors

Unit shall be furnished with a leak detection system from the factory when a circuit refrigerant charge exceeds 3.91 lbs. The leak detection system shall consist of one or more refrigerant detection sensors. When the system detects a leak, the unit controller shall initiate mitigation actions.

Notes:

1. *Factory-installed Symbio™ 500 controllers are programmed with leak detection sequence of operations at the factory.*
2. *Field-installed unit controllers require field programming of the UL leak detection sequence of operations by the controls contractor.*
3. *Factory-installed digital terminal blocks, which use a non-programmed Symbio 500 controller, require field programming of the leak detection sequence of operations by the controls contractor.*
4. *See UL 60335–2–40 for more information.*



The AHRI Certified mark indicates Trane U.S. Inc. participation in the AHRI Certification program. For verification of individual certified products, go to ahridirectory.org.

Trane - by Trane Technologies (NYSE: TT), a global innovator - creates comfortable, energy efficient indoor environments for commercial and residential applications. For more information, please visit trane.com or tranetechnologies.com.

Trane has a policy of continuous product and product data improvements and reserves the right to change design and specifications without notice. We are committed to using environmentally conscious print practices.