



Product Catalog

Thermafit™ Modular

AMC, AXM, MWC, WXM, MAS, MWS, MAR, TACW





Introduction

Design and manufacturing excellence make Trane a leader in the chiller marketplace. This tradition of using excellence to meet market demands is illustrated with the Trane Thermafit™ modular product line. These modular units offer true redundancy and simplified service and as with any modular, they are easy to expand.

AMC air-cooled chiller



MWC water-cooled chiller



AXM air-to-water heat pump



WXM water-to-water heat pump



MAS air-source multipipe



MWS water-source multipipe



MAR air-cooled split system
with remote condenser



TACW water-cooled oil-free
magnetic bearing chiller



Copyright

This document and the information in it are the property of Trane, and may not be used or reproduced in whole or in part without written permission. Trane reserves the right to revise this publication at any time, and to make changes to its content without obligation to notify any person of such revision or change.

Trademarks

All trademarks referenced in this document are the trademarks of their respective owners.



Table of Contents

Application Considerations	7
Bank and Module Sizing	7
Water Treatment	7
Design Fluid and Air Temperature Limits	8
Operating Temperature Limits	9
Effect of Altitude on Capacity	9
Ambient Limitation	9
Hydronic System Fluid Volume	10
Variable Flow	10
Heat Pump	11
Heat Recovery	11
Integrated Free Cooling	12
Glycol	12
AMC Modular Air-Cooled Chiller	14
Features and Benefits	14
General Data	15
Unit Dimensions and Weights	16
Service Clearance	18
MWC Modular Water-Cooled Chiller	19
Features and Benefits	19
General Data	20
Unit Dimensions and Weights	22
Service Clearance	23
AXM Modular Air-to-Water Heat Pump	24
Features and Benefits	24
General Data	25
Unit Dimensions and Weights	26
Service Clearance	27
WXM Modular Water-to-Water Heat Pump	28
Features and Benefits	28
General Data	29
Unit Dimensions and Weights	30
Service Clearance	31

MAS Modular Air-Source Multipipe	32
Features and Benefits	32
General Data	33
Unit Dimensions and Weights	34
Service Clearance	35
MWS Modular Water-Source Multipipe	36
Features and Benefits	36
General Data	37
Unit Dimensions and Weights	38
Service Clearance	40
MAR Modular Split System with Remote Condenser	41
Features and Benefits	41
General Data	42
Unit Dimensions and Weights	43
Service Clearance	45
TACW Modular Magnetic Bearing Water-Cooled Centrifugal Chiller	46
Features and Benefits	46
General Data	47
Unit Dimensions and Weights	48
Service Clearance	49
Controls	50
Carel c.pCO OEM Controller	50
EXOR eSmart07 Touch-Screen HMI	51
Danfoss MCX OEM Controller	52
Schneider 7-inch HMI Touchscreen	53
Building Management System (BMS)	53



Table of Contents

Mechanical Specifications	54
General	54
Refrigeration Circuits	54
Evaporator	54
Brazed Plate Heat Exchanger	55
Flooded Shell and Tube Evaporator/Condenser	55
Condenser and Fans	55
Air Coils and Fans	56
Compressor	56
Unit Controls	56
Options	58
Application Options	58
High Ambient Operation	59
Low Ambient Operation	60
Electrical Options	61
Control Options	62
Sound Options	62
Other Options	62



Application Considerations

Proper application considerations must be taken into account when sizing, selecting, and installing Trane modular chillers and heat pumps. Improper application can impact system performance and system reliability. Deviations from these recommendations should be reviewed with your local sales representative.

Bank and Module Sizing

There are two separate sizing calculations used when designing and selecting a modular chiller/heat pump system. They are:

- Bank sizing
- Module sizing

Bank Sizing: The design operating capacity of the bank should be based on the HVAC system peak block load, either cooling or heating, not the sum of the peaks of all the individual system loads. Do not include redundancy requirements in the design operating capacity. An oversized chiller is more expensive to purchase, install, and operate. A provision for redundancy is discussed below.

Module Sizing: The proper number and size of modules that makes up the chiller/heat pump bank is dependent on several factors:

- **Required steps of unloading:** The designer must decide the number of chiller/heat pump steps of unloading appropriate for the application. The number and size of the steps can significantly impact system and module operating characteristics:
 - Rate of compressor cycling at part and minimum load
 - Stability of chilled water temperature control
 - Accuracy of chilled water temperature control
 - System minimum chilled water volume required

For typical medium to large comfort cooling applications, it is a best practice for the chiller/heat pump to have at least four steps of unloading. This implies a 25% minimum step of unloading. More steps of unloading provide operating benefits but may excessively increase unit first cost.
- **Low Load Operation:** Both the system peak block and the minimum expected operating loads should be evaluated when deciding on the number and size of the unloading steps. If extended periods of very low load are expected, less than the minimum step of default module unloading, it is better to select a chiller/heat pump bank with more smaller modules to provide for superior capacity turndown. A chiller/heat pump with fewer larger modules may be forced to excessively cycle compressors.
- **Redundancy:** One advantage of modular chillers is N+1 redundancy can be achieved by simply adding one extra module to the bank. This is the preferred method for adding redundancy as it does not impact control accuracy or other system design requirements. Adding an incremental module is typically less costly and complex than adding another full 100% load chiller in a packaged chiller/heat pump system. The chiller/heat pump bank controller automatically enables the redundant module in the event of a failure in another module. The redundant module is also rotated into the lead/lag sequence to ensure it is operational when needed and for even run time.
- **System Fluid Volume:** The capacity of the module refrigeration circuit drives the system minimum fluid volume. Larger capacity modules drive the need for greater system volume. See [“Hydronic System Fluid Volume,” p. 10](#) below for volume requirement details.

Water Treatment

The use of untreated or improperly treated water may result in scaling, corrosion, and algae or slime buildup in the chiller/heat pump heat exchangers and associated piping and components. This will adversely affect heat transfer between the water and heat exchangers and may lead to premature equipment piping and/or component failure. Below are the fluid quality guidelines for heat exchanger scaling and corrosion management. Algae and slime buildup is managed with microbiological control agents.



Application Considerations

Table 1. Water treatment

Element/Compound/Property	Value/Unit
pH	7.5 – 9.0
Conductivity	< 500 μ S/cm
Total Hardness	4.5 – 8.5 dH°
Free Chlorine	< 1.0 ppm
Ammonia (NH ₃)	< 0.5 ppm
Sulphate (SO ₄ ²⁻)	< 100 ppm
Hydrogen Carbonate (HCO ₃ .)	60 – 200 ppm
(HCO ₃ .)/(SO ₄ ²⁻)	> 1.5
(Ca+Mg)/(HCO ₃ .)	> 0.5
Chloride (Cl-)	< 200 ppm

Salt and brackish water must not be used in water-cooled chillers. Trane recommends using a qualified water treatment specialist to assist in establishing a proper water treatment program.

Foreign matter in the chilled water system can also foul the chiller system piping, heat exchangers, and strainers thereby increasing pressure drop and reducing fluid flow. A 40- mesh screen strainer must be installed in each water/liquid system piping inlet for proper filtration and protection of the heat exchangers. It is important to thoroughly flush all piping in the hydronic system before making the final piping connections to the system.

Design Fluid and Air Temperature Limits

Note: This section applies only to MWS models.

MWS multipipe units have three heat exchangers with distinct water temperature design limits. The following are the individual heat exchanger's acceptable selection ranges. Note that a unit may not be selectable at the combined extreme temperatures of each individual heat exchanger. It should also be noted that the maximum hot water temperature is limited by the compressor operating envelope and achievable only at higher evaporator or source liquid temperatures.

- The maximum fluid temperature that can be circulated through any unit heat exchanger when the unit is not operating is 120°F (48.9°C).
- The evaporator/chilled fluid leaving temperature range with water is 42°F to 65°F (5.6°C to 18.3°C). The condenser/heating fluid leaving temperature range is 90°F to 140°F (32.2°C to 60°C).
- The source/sink heat exchanger leaving fluid temperature range in the COOLING DOMINANT MODE (rejecting heat) is 45°F to 90°F (7.2°C to 32.2°C).
- The source/sink heat exchanger leaving fluid temperature range in the HEATING DOMINANT MODE (absorbing heat) with water is 42°F to 90°F (5.6°C to 32.2°C). With the appropriate glycol concentration, the leaving fluid temperature may be as low as 30°F (-1.1°C).

Note: This section applies only to MAS models.

MAS multipipe units have two brazed-plate heat exchangers and one air coil with distinct water/air temperature design limits. The following are the individual heat exchanger's acceptable selection ranges.

Notes:

- A unit may not be selectable at the combined extreme temperatures of each individual heat exchanger.
- The maximum hot water temperature is limited by the compressor-operating envelope and achievable only at higher evaporator or source liquid temperatures.
- The maximum fluid temperature that can be circulated through any unit heat exchanger when the unit is not operating is 120°F (48.9°C).

- The evaporator/chilled fluid leaving temperature range with water is 42°F to 65°F (5.6°C to 18.3°C). The condenser/heating fluid leaving temperature range is 65°F to 140°F (18.3°C to 60°C).
- The source/sink coil entering air temperature range in the COOLING DOMINANT MODE (rejecting heat) is 40°F to 115°F (4.4°C to 46.1°C).
- The source/sink coil entering air temperature range in the HEATING DOMINANT MODE (absorbing heat) is 0°F to 95°F (-17.7°C to 35°C). With the appropriate glycol concentration, the leaving fluid temperature may be as low as 30°F (-1.1°C).

Operating Temperature Limits

Note: This section applies only to MAS and MWS models.

The actual operating cooling and heating temperatures available from a MAS and MWS multi-pipe unit are dependent upon the combination of cooling and heating loop conditions. Actual system operating temperatures often differ from selected design temperatures and may be more extreme. Validating the equipment's ability to operate at the expected operating extremes is important for sustained reliable operation. When deciding upon system design conditions be sure to select the most extreme operating conditions to ensure the equipment can meet the system requirements. Some operating conditions to consider include:

Note: The source/sink temperature referenced below refers to the ambient temperature for MAS and the geothermal loop (typically) temperature for MWS.

- Heating Mode Operational Checks:
 - Minimum source/sink temperature that allows for heating mode operation.
 - Minimum source/sink conditions at which unit can produce design leaving heating fluid temperature.
 - Heating capacity at design leaving heating fluid temperature and minimum allowed source/sink temperature.
 - Maximum leaving heating fluid temperature at the minimum expected source/sink temperature.
 - Heating capacity at the minimum expected source/sink temperature and corresponding maximum leaving heating fluid temperature.
- Cooling Mode Operational Checks:
 - Maximum source/sink temperature that allows for cooling mode operation.
 - Source/sink conditions at which unit can produce design leaving chilled water fluid temperature.
 - Cooling capacity at design leaving chilled fluid temperature and maximum allowed source/sink temperature. Minimum leaving chilled fluid temperature at the maximum expected source/sink temperature.
 - Cooling capacity at the maximum expected source/sink temperature and corresponding minimum leaving chilled fluid temperature.
- Simultaneous Cooling and Heating:
 - Minimum leaving chilled fluid temperature at design heating leaving fluid temperature.

Effect of Altitude on Capacity

Note: This section applies only to AMC, AXM, MAR and MAS models.

At elevations substantially above sea level, the decreased air density will decrease condenser capacity and, therefore, unit capacity and efficiency.

Ambient Limitation

Note: This section applies only to AMC, AXM, MAR and MAS models.

Trane modular chillers are designed for year-round operation over a range of ambient temperatures.

- Ambient temperatures from 0°F to 110°F are standard (*applies to AMC and MAR*).



Application Considerations

- Ambient temperatures from 40°F to 115°F in cooling mode are standard. Ambient temperatures from 0°F to 95°F are standard in heating mode (*applies to AXM and MAS*).
- Ambient temperatures from 0°F to -20°F require flooded condenser head pressure control or integral free cooling coils.
- Ambient temperatures above 110°F must have an oversized condenser; oversized condensers are not available for 40 ton and 80 ton module sizes (*applies to AMC*).

Hydronic System Fluid Volume

Adequate fluid volume is an important system design consideration because it provides for stable chilled fluid temperature control and limits unacceptable short cycling of compressors.

The chiller/heat pump's system temperature control sensors are located in the provided field-installed spool pieces on the supply (outlet) load fluid pipe header and return (entering) load fluid pipe header. The system temperature sensors dictate when compressors energize and de-energize in relation to the temperature setpoint. This location allows the building piping to act as a buffer to slow the rate of change of the system water temperature. If there is not sufficient fluid volume in the system to provide an adequate buffer, temperature control will be erratic, and the compressor will cycle excessively.

Note: *This section applies only to AMC, MAR, MWC, and WXM models.*

For Trane modular chillers/heat pumps in typical comfort cooling applications, the minimum hydronic system volume should be 25 times the smallest refrigeration circuit capacity in the Chiller Bank— or the smallest unloading step. For example, if the smallest refrigerant circuit is 15 tons without a compressor VFD, the minimum hydronic volume would be $25 \times 15 = 375$ gallons. For systems with a rapidly changing load profile, the volume should be increased.

If the installed system volume does not meet the above recommendations, one or more of the following considerations are necessary to reduce the rate of change of the return water temperature and/or allow for greater refrigeration circuit unloading.

- A volume buffer tank located in the return water piping.
- Larger system supply and return header piping (which also reduces system pressure drop and pump energy use).
- A variable speed drive to one or more compressors in the chiller system for closer temperature control and unloading.

Note: *This section applies only to AXM, MAS and MWS models.*

For Trane Thermafit AXM, MAS, and MWS modular chillers/heat pumps, a minimum of fifty times a module's nominal capacity or four-minute full load water circulation, whichever is greater, is the recommended fluid system volume. So, as an example, for five 30 nominal ton bank, $30T \times 50 = 1,500$ gallons. Assuming 2.4 gpm per ton for full load flow rate, $150 \times 2.4 \times 4 = 1,440$ gallons. So, the greater value of 1,500 gallons is recommended.

If the installed system volume does not meet the above recommendations, one or more of the following considerations are necessary to reduce the rate of change of the return water temperature and/or allow for greater refrigeration circuit unloading.

- A volume buffer tank located in the return water piping.
- Larger system supply and return header piping (which also reduces system pressure drop and pump energy use).

Note: *This section applies only to TACW models.*

For Trane Thermafit TACW modular chillers, the full load flow (GPM) per module x number of modules x 3 min equals total volume of buffer tank in US gallons OR each module's nominal ton x number of modules x 8. Whichever is greater is the recommended fluid system volume.

Variable Flow

Trane Thermafit modular chillers/heat pumps are designed to work in many common system configurations including: primary/secondary (P/S or decoupled), variable primary / variable secondary

(VP/VS), and variable primary flow (VPF) systems. See *Modular Chillers in Variable Primary Flow Chilled-Water Systems - Application Guide* (PKG-APG001*-EN) or contact your Trane Sales office.

Variable flow systems, those with two-way control valves controlling AHU coils are popular, and/or required by codes because of their energy efficient operating characteristics. VPF systems in particular are favored for having a single set of pumps thus reducing first cost. VP/VS system configurations are growing in popularity for their stability of operation and potential pumping energy savings depending on the chiller characteristics.

Distribution pump speed is typically controlled to maintain a target differential pressure (DP) at a specific point in the system (at the most remote equipment user). The distribution system flow is a function of coil two-way control valve operation and pump speed. The range of flow allowed by the chiller is a function of the module's fluid heat exchanger selection and the number of active modules. Independent of the distribution system flow the chiller's flow must be maintained within a safe operating range. In VPF systems this is typically accomplished through control of a minimum flow bypass valve. In VP/VS systems chiller flow is controlled through primary (chiller) pump speed control.

Trane modular chillers/heat pumps have several available options that enable or enhance variable fluid flow operation.

The optional automatic isolation valves per module heat exchanger stops flow through a module when its compressors are cycled off reducing the total flow required by the chiller. When increased capacity is required dictating the operation of another module, the valve to the additional module is opened to allow for compressor operation. The chiller/heat pump bank controller signals the BAS /pumping control system the number of active modules to enable the proper control of flow.

Pump Modules with various hydronic specialties are optionally available. The pumping modules include sequences compatible with various system configurations including VPF.

Heat Pump

Note: *This section applies only to AXM and WXM models.*

A typical HVAC system has a cooling requirement in the summer and shoulder seasons and a heating requirement in the winter and shoulder seasons. A modular heat pump system is well suited to this cyclic cooling and heating demand. The heat pump system can be sized for the greater of the cooling demand or heating demand. When the smaller of the demands is operating, not all modules function thereby saving energy costs and improving efficiency. This also allows for the non-operating modules to be on reserve should any of the modules require servicing.

When the HVAC system demand switches between heating and cooling the heat pump mode is switched and the reversing valve in each functioning module reverses the refrigerant cycle to produce the required heating or cooling supply. The heat pump unit does not simultaneously heat and cool. It only produces either heating or cooling depending on the commanded mode of operation. For AXM modules, the ambient air provides for the heat source/sink. When operating in heating mode in low temperature moist climates, frost may form on the outdoor coils. The AXM modules, periodically defrost the outdoor coils by reversing the refrigerant cycle for a period of time. Modules are sequentially defrosted to minimize the impact to heating capacity. The defrost cycle must be taken into account when sizing the hydronic system volume to ensure heating demand is met.

Heat Recovery

Note: *This section applies only to AMC, MAS, MWC, and MWS models.*

Unlike a heat pump, heat recovery modules do not have reversible refrigeration circuits. Heat recovery applications primarily control to a supply heating temperature and typically source energy from the HVAC system chilled water loop for heating use. There must be a cooling load to satisfy a heating load and vice versa. For AMC, the recovered energy is delivered to the hot fluid loop by diverting the compressor refrigerant discharge into a water-cooled heat exchanger instead of into the air-cooled condenser.



Integrated Free Cooling

Note: This section applies only to AMC models.

The free cooling option delivers optimal performance by minimizing compressor operation when outdoor air temperatures are low enough to assist in cooling the chilled fluid loop.

The integrated chiller fluid-based free-cooling system consists in a set of coils, installed in the same frame as the condenser coils of the chiller refrigerant circuit. Free-cooling coils are installed in series ahead of the evaporator. A set of water regulating valves modulate flow and allow the coils to be by-passed when ambient temperatures are no longer favorable for free-cooling operation.

Free-cooling coils will be all aluminum, flat radiator design type, with low air pressure drop to avoid fan performance degradation.

Glycol

Glycols are used in HVAC systems to prevent damage from corrosion and freezing. Glycol suppliers provide concentration data for freeze protection and burst protection.

As the temperature drops below the inhibited glycol solution's freeze point, ice crystals will begin to form. Because the water freezes first, the remaining glycol solution is further concentrated and remains fluid. The combination of ice crystals and fluid makes up a flowable slush. The fluid volume increases as this slush forms and flows into available expansion volume.

Freeze protection indicates the concentration of glycol required to prevent ice crystals from forming at the given temperature. Burst protection indicates the concentration required to prevent damage to equipment (example: coil tubes bursting). Burst protection requires a lower concentration of glycol, which results in less degradation of heat transfer capacity.

Burst protection is usually sufficient in systems that are inactive during winter and there is adequate space to accommodate the expansion of an ice/slush mixture. Given a sufficient concentration of glycol for burst protection, no damage to the system will occur. Burst protection is also appropriate for closed-loop systems which must be protected despite power or pump failure. An example is an air-cooled chilled-water system that does not need to run during subfreezing weather.

Freeze protection is mandatory in those cases where no ice crystals can be permitted to form or where there is inadequate expansion volume available. An example is a coil runaround loop. Also, HVAC systems that must start-up during cold weather following prolonged winter shutdowns may require freeze protection. However, specify freeze protection only when the fluid must remain 100% liquid at all times.

For either freeze or burst protection, the required concentration of glycol depends on the operating conditions of the system and the lowest expected ambient temperature. Often, the concentration is selected based on a temperature that is at least 5° F lower than the lowest anticipated design operating temperature. Table below is an excerpt from product information bulletins published by The Dow Chemical Company. Be sure equipment selections are made at the required glycol concentration to ensure proper sizing.

Table 2. Glycol

Temperature (°F)	DOWTHERM SR-1 (Ethylene glycol)		DOWFROST HD (Propylene glycol)	
	Freeze	Burst	Freeze	Burst
20	16.80%	11.50%	18%	12%
10	26.20%	17.80%	29%	20%
0	34.60%	23.10%	36%	24%
-10	40.90%	27.30%	42%	28%
-20	46.10%	31.40%	46%	30%
-30	50.30%	31.40%	50%	33%
-40	54.50%	31.40%	54%	35%

Table 2. Glycol (continued)

Temperature (°F)	DOWNTHERM SR-1 (Ethylene glycol)		DOWNFROST HD (Propylene glycol)	
	Freeze	Burst	Freeze	Burst
-50	58.70%	31.40%	57%	35%
-60	62.90%	31.40%	60%	35%

Freeze Avoidance

***Important:** If equipment is located in a climate which rarely sees freezing ambient temperatures, it can still experience freezing conditions due to refrigerant migration.*



AMC Modular Air-Cooled Chiller

- 15 to 80 nominal tons per module
- Maximum of 12 modules
- Up to 960 tons per chiller bank



Features and Benefits

- Dual R-454B refrigeration circuits on each chiller module.
- Hermetic scroll compressor on each refrigeration circuit with crankcase heater, solid-state overload protection, and in-line circuit breaker.
- Dual circuit, brazed plate evaporator in each chiller module.
- Fine mesh strainer.
- Thermal dispersion flow switch .
- Manual isolation valves on each evaporator branch line to permit service isolation of the flow switch, strainer, and evaporator.
- Individual module servicing and strainer cleaning while balance of chiller system remains operational.
- Aluminum finned /copper tube condenser coils.
- ECM type, refrigeration pressure-controlled, variable speed fan/motor assemblies for quiet operation.
- Variable speed fan condenser head pressure control for 0° F ambient.
- Phase monitor on the power supply to protect against low voltage, phase unbalance, phase loss, and phase reversal conditions.
- Roll grooved header pipe connections.

- 3/4-inch Insulation on each evaporator, fluid piping, and components.
- Galvanized sheet metal frames, powder-coated with an oven-baked finish.
- Primary microprocessor controller provides current alarm status, alarm logging of the previous 2000 alarms, fluid temperatures for each module, refrigeration pressure on each refrigeration circuit, compressor run hours, current status display, remote on/off, general alarm contacts, and BMS connectivity.
- Distributed secondary microprocessor controller on each secondary module to allow continued operation should there be a failure of the primary microprocessor controller. (Only applicable when one or more secondary modules are required).
- 7-inch touchscreen graphical interface display installed on the primary module of the chiller system.
- Free-Cooling and Heat-Recovery configurations available.
- Cellular VPN router allows for optional remote internet monitoring, remote control, and access to operational logs and software updates.

General Data

Table 3. General data – Thermafit™ AMC chiller

Capacity (Tons)	15	20	25	30	40	50	60	80
General Unit								
Number of Independent Refrigeration Circuits	DUAL	DUAL	DUAL	DUAL	DUAL	DUAL	DUAL	DUAL
Chilled Fluid Volume (gal/module)	4.7 ^(a)	5.1 ^(a)	8.9 ^(b)	9.2 ^(b)	13.4 ^(b)	14.6 ^(b)	17.5 ^(b)	20.7 ^(b) /27.1 ^(c)
Compressor								
Type	SCROLL	SCROLL	SCROLL	SCROLL	SCROLL	SCROLL	SCROLL	SCROLL
Quantity	2	2	2	2	2	2	2	2
Evaporator								
Type	BRAZED PLATE	BRAZED PLATE	BRAZED PLATE	BRAZED PLATE	BRAZED PLATE	BRAZED PLATE	BRAZED PLATE	BRAZED PLATE
Quantity	1	1	1	1	1	1	1	1
Fluid Volume (gal)	1.40	1.80	2.30	2.50	4.00	5.00	7.50	7.20
Fouling Factor (hr ft ² -F/Btu)	0.0001	0.0001	0.0001	0.0001	0.0001	0.0001	0.0001	0.0001
Material (plates/brazing)	316 SST/CU	316 SST/CU	316 SST/CU	316 SST/CU	316 SST/CU	316 SST/CU	316 SST/CU	316 SST/CU
Minimum/Maximum Leaving Water Temperatures (°F)	42-65	42-65	42-65	42-65	42-65	42-65	42-65	42-65
Minimum/Maximum Leaving Brine Temperatures (°F)	10-65	10-65	10-65	10-65	10-65	10-65	10-65	10-65
Minimum Water/Brine Operating Pressure (psig)	0	0	0	0	0	0	0	0
Maximum Water/Brine Operating Pressure (psig) Standard Option	200	200	200	200	200	200	200	200
Maximum Water/Brine Operating Pressure (psig) Hi Pressure Option	300	300	300	300	300	300	300	300
Condenser Fans								
Motor Type	EC	EC	EC	EC	EC	EC	EC	EC
HP	1.4	1.4	2.5	2.5	4.2	2.5	2.5	4.2
Fan Type	AXIAL	AXIAL	AXIAL	AXIAL	AXIAL	AXIAL	AXIAL	AXIAL



AMC Modular Air-Cooled Chiller

Table 3. General data – Thermafit™ AMC chiller (continued)

Capacity (Tons)	15	20	25	30	40	50	60	80
Air Flow (cfm/module)	14000	14000	21000	21000	23000	42000	42000	46000
Condenser Coils								
Fin Material	ALUM	ALUM	ALUM	ALUM	ALUM	ALUM	ALUM	ALUM
Fin/in (FPI)	12	12	16	16	12	16	16	12
Tube Material	COPPER	COPPER	COPPER	COPPER	COPPER	COPPER	COPPER	COPPER
Tube Diameter (mm)	0.375 (9.5)	0.375 (9.5)	0.375 (9.5)	0.375 (9.5)	0.375 (9.5)	0.375 (9.5)	0.375 (9.5)	0.375 (9.5)
Number of Rows	4	4	3	3	4	3	3	4
Coil Dimensions (in.)	32x64	32x64	36x88	36x88	40x88	36x88	36x88	40x88
Coil Quantity	2	2	2	2	2	4	4	4

- (a) 4-inch pipe headers .
- (b) 6-inch pipe headers.
- (c) 8-inch pipe headers.

Unit Dimensions and Weights

Figure 1. AMC air-cooled modulares - 15 to 40 tons

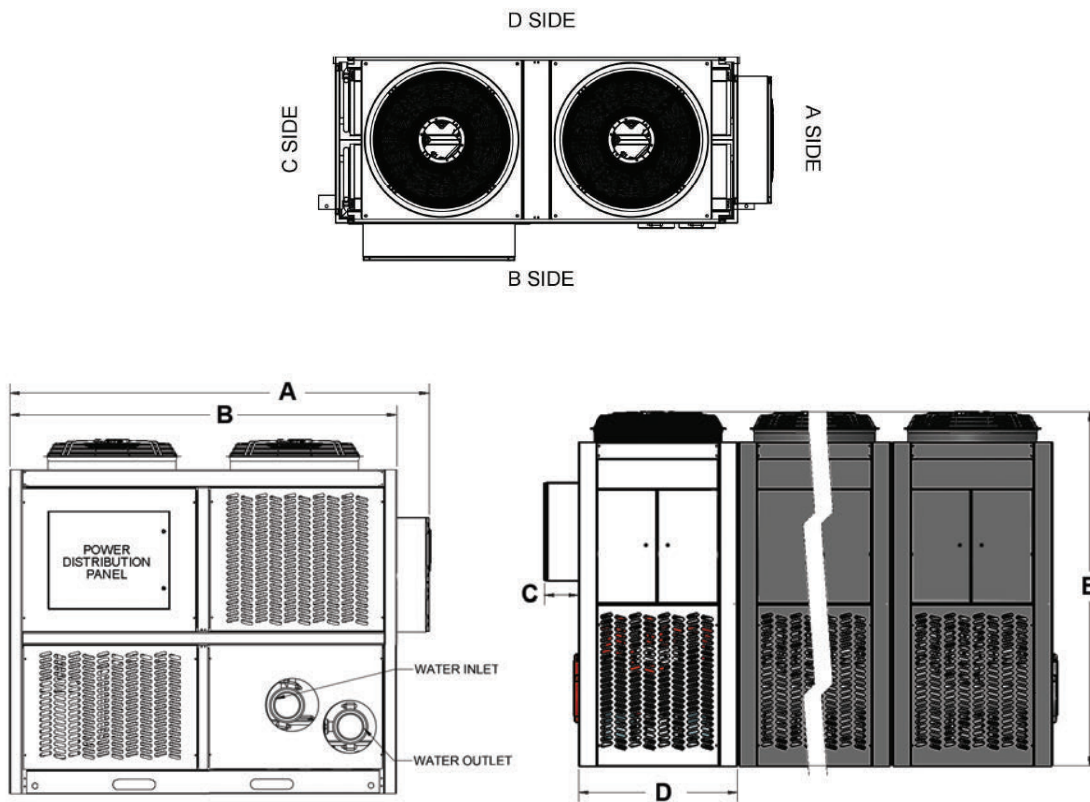

Table 4. Unit dimensions and weight - 15 to 40 tons (AMC)

Dim	Units	Unit Sizes and Weights Per Module				
		15 Tons	20 Tons	25 Tons	30 Tons	40 Tons
A	inch	84	84	103	103	103
B		76	76	95	95	95
C		8	8	8	8	8
D		33	33	39.25	39.25	48
E		76	76	88.75	88.75	89.5
Weight	lbs	1800	1800	2500	2500	3000

Figure 2. AMC air-cooled modulares - 50 to 80 tons

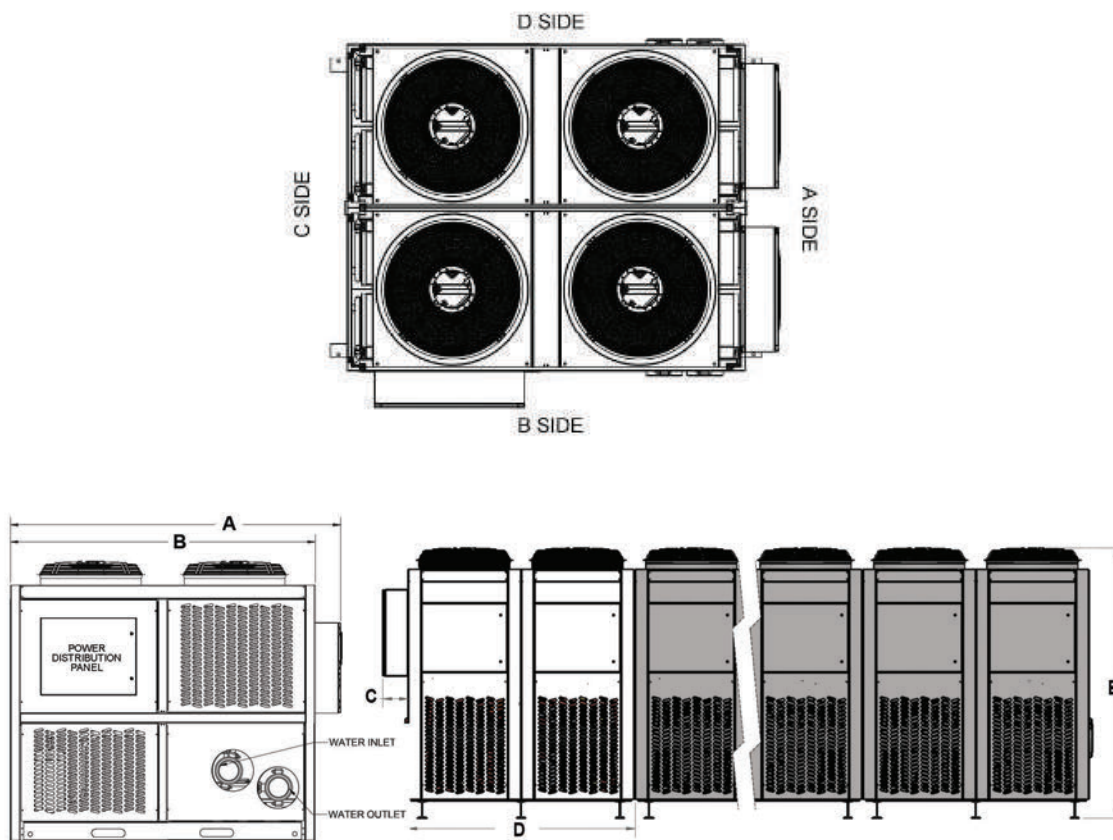
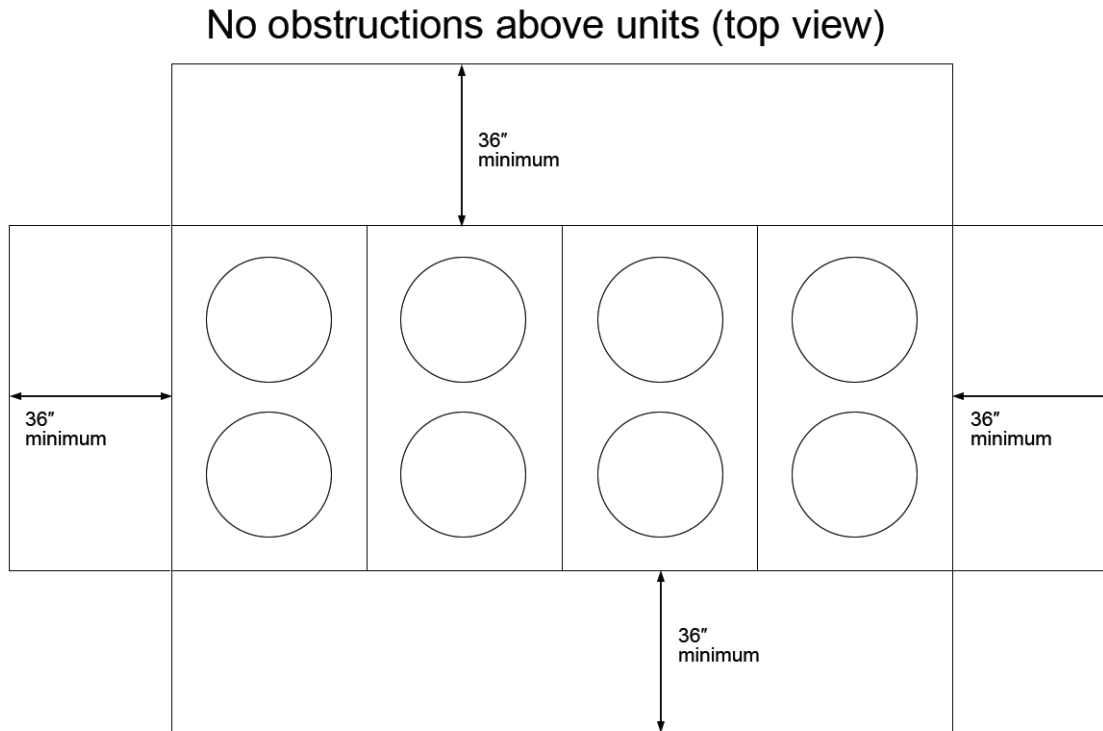

Table 5. Unit dimensions and weight - 50 to 80 tons (AMC)

Dim	Units	Unit Sizes and Weights Per Module		
		50 Tons	60 Tons	80 Tons
A	inch	103	103	103
B		95	95	95
C		8	8	8
D		78.5	78.5	96
E		95.25	95.25	96
Weight	lbs	5000	5000	6000

Service Clearance

Figure 3. AMC service clearance



NOTE: If unit is surrounded by a fence, the minimum clearance is 48 inches. The fence must allow 50% airflow.



MWC Modular Water-Cooled Chiller

- 15 to 80 nominal tons per module
- Maximum of 12 modules
- Up to 960 tons per chiller bank



Features and Benefits

- Dual R-454B refrigeration circuits on each chiller module.
- Hermetic scroll compressor on each refrigeration circuit with crankcase heater, solid-state overload protection, and in-line circuit breaker.
- Dual circuit, brazed plate evaporator in each chiller module.
- Fine mesh evaporator strainer.
- Thermal dispersion evaporator fluid flow switch.
- Manual isolation valves on each evaporator branch line to permit service isolation of the flow switch, strainer, and evaporator.
- Dual circuit, brazed plate condenser in each chiller module.
- Fine mesh condenser strainer.
- Thermal dispersion condenser fluid flow switch.
- Manual isolation valves on each condenser branch line to permit service isolation of the flow switch, strainer, and evaporator.
- Individual module servicing and strainer cleaning while balance of chiller system remains operational.



MWC Modular Water-Cooled Chiller

- Phase monitor on the power supply to protect against low voltage, phase unbalance, phase loss, and phase reversal conditions.
- Roll grooved header pipe connections.
- 3/4-inch Insulation on each evaporator, fluid piping, and components.
- Formed sheet metal frames, powder-coated with an oven-baked finish.
- Primary microprocessor controller provides current alarm status, alarm logging of the previous 2000 alarms, fluid temperatures for each module, refrigeration pressure on each refrigeration circuit, compressor run hours, current status display, remote on/off, general alarm contacts, and BMS connectivity.
- Distributed secondary microprocessor controller on each secondary module to allow continued operation should there be a failure of the primary microprocessor controller. (Only applicable when one or more secondary modules are required).
- 7-inch touchscreen graphical interface display installed on the primary module of the chiller system.
- Heat-Recovery configurations for R4545B and R513A available.
- Cellular VPN router allows for optional remote internet monitoring, remote control, and access to operational logs and software updates.

General Data

Table 6. General data - Thermafit™ MWC chiller

Capacity (Tons)	15	20	25	30	40	50	60	80
General Unit								
Number of Independent Refrigeration Circuits	DUAL	DUAL	DUAL	DUAL	DUAL	DUAL	DUAL	DUAL
Chilled Fluid Volume(gal/module)	6.5 ^(a)	6.9 ^(a)	8.9 ^(b)	9.2 ^(b)	13.4 ^(b)	14.6 ^(b)	17.5 ^(b)	20.7 ^(b) / 27.1 ^(c)
Condenser Fluid Volume (gal/module)	6.8 ^(a)	7.5 ^(a)	9.1 ^(b)	9.4 ^(b)	14.1 ^(b)	15.1 ^(b)	18.3 ^(b)	24.3 ^(b) / 30.7 ^(c)
Compressor								
Type	SCROLL	SCROLL	SCROLL	SCROLL	SCROLL	SCROLL	SCROLL	SCROLL
Quantity	2	2	2	2	2	2	2	2
Evaporator^(d)								
Type	BRAZED PLATE	BRAZED PLATE	BRAZED PLATE	BRAZED PLATE	BRAZED PLATE	BRAZED PLATE	BRAZED PLATE	BRAZED PLATE
Quantity	1	1	1	1	1	1	1	1
Fluid Volume (gal)	1.75	2.3	2.5	2.7	4.6	5.5	8.5	13.31
Material (plates/brazing)	316 SST/CU	316 SST/CU	316 SST/CU	316 SST/CU	316 SST/CU	316 SST/CU	316 SST/CU	316 SST/CU
Minimum/Maximum Leaving Water Temperatures (°F)	42-65	42-65	42-65	42-65	42-65	42-65	42-65	42-65
Minimum/Maximum Leaving Brine Temperatures (°F)	10-65	10-65	10-65	10-65	10-65	10-65	10-65	10-65
Minimum Water/Brine Operating Pressure (psig)	0	0	0	0	0	0	0	0
Maximum Water/Brine Operating Pressure (psig) Standard Option	200	200	200	200	200	200	200	200
Maximum Water/Brine Operating Pressure (psig) Hi Pressure Option	300	300	300	300	300	300	300	300
Condenser^(e)								
Type	BRAZED PLATE	BRAZED PLATE	BRAZED PLATE	BRAZED PLATE	BRAZED PLATE	BRAZED PLATE	BRAZED PLATE	BRAZED PLATE
Quantity	1	1	1	1	1	1	1	1

Table 6. General data - Thermafit™ MWC chiller (continued)

Capacity (Tons)	15	20	25	30	40	50	60	80
Fluid Volume (gal)	1.75	2.3	2.5	2.7	4.6	5.5	8.5	13.31
Material (plates/brazing)	316 SST/CU	316 SST/CU	316 SST/CU	316 SST/CU	316 SST/CU	316 SST/CU	316 SST/CU	316 SST/CU
Minimum Water/Brine Operating Pressure (psig)	0	0	0	0	0	0	0	0
Maximum Water/Brine Operating Pressure (psig) Standard Option	200	200	200	200	200	200	200	200
Maximum Water/Brine Operating Pressure (psig) Hi Pressure Option	300	300	300	300	300	300	300	300
Minimum/Maximum Leaving Water Temperatures (°F)	N/A	N/A	90-140	90-140	90-140	90-140	90-140	90-140
Minimum/Maximum Leaving Brine Temperatures (°F)	N/A	N/A	90-140	90-140	90-140	90-140	90-140	90-140
Condenser								
Type	N/A	N/A	Shell And Tube	Shell And Tube	Shell And Tube	Shell And Tube	Shell And Tube	Shell And Tube
Quantity	N/A	N/A	1	1	1	1	1	1
Minimum Water/Brine Operating Pressure (psig)	0	0	0	0	0	0	0	0
Maximum Water/Brine Operating Pressure (psig) Standard Option	N/A	N/A	150	150	150	150	150	150
Maximum Water/Brine Operating Pressure (psig) Hi Pressure Option	N/A	N/A	300	300	300	300	300	300
Minimum/Maximum Leaving Water Temperatures (°F)	N/A	N/A	90-140	90-140	90-140	90-140	90-140	90-140
Minimum/Maximum Leaving Brine Temperatures (°F)	N/A	N/A	90-140	90-140	90-140	90-140	90-140	90-140

- (a) 4-inch pipe headers.
- (b) 6-inch pipe headers.
- (c) 8-inch pipe headers.
- (d) Evaporator Fouling Factor is 0.0001.
- (e) Condenser Fouling Factor is 0.00025.



MWC Modular Water-Cooled Chiller

Unit Dimensions and Weights

Figure 4. MWC air-cooled modulares - 15 to 80 tons

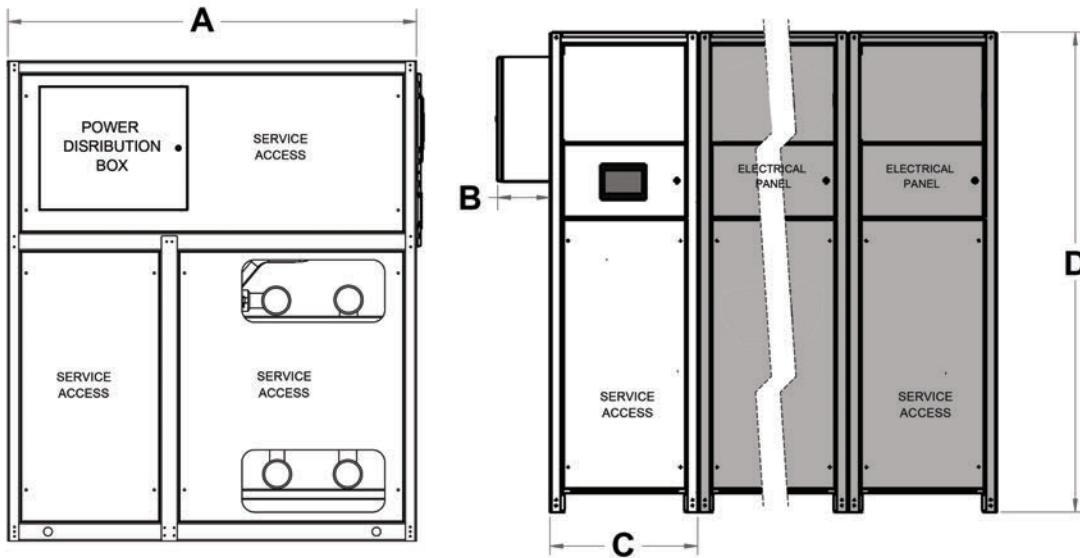
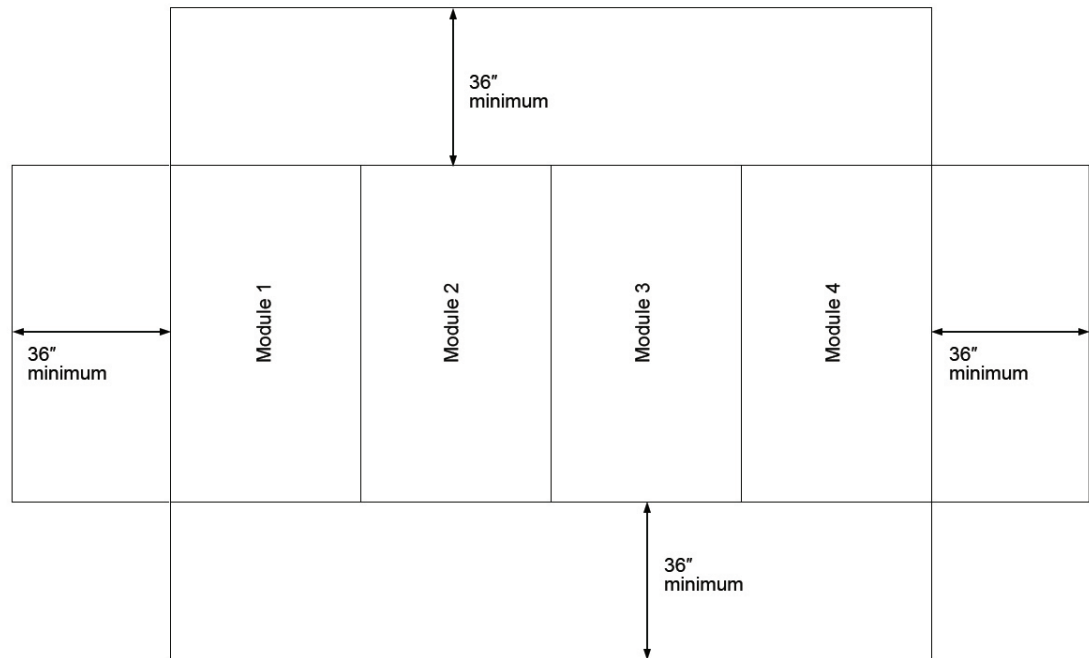

Table 7. Unit dimensions and weight - 15 to 80 tons (MWC)

Dim	Units	Unit Sizes and Weights Per Module							
		15 Tons	20 Tons	25 Tons	30 Tons	40 Tons	50 Tons	60 Tons	80 Tons
A	inch	66	66	66	66	66	66	66	79
B		8.5	8.5	8.5	8.5	8.5	8.5	8.5	8.5
C		24	24	24	24	34	34	34	42
D		77	77	77	77	77	77	77	80
Weight	lbs	1400	1400	1500	1600	2100	2200	2400	2600

Service Clearance

Figure 5. MWC service clearance



NOTE: 48 inches minimum overhead clearance



AXM Modular Air-to-Water Heat Pump

- 30 nominal tons per module
- Maximum of 10 modules / Minimum of 2 modules
- Up to 300 tons per chiller bank



Features and Benefits

- Dual R-454B refrigeration circuits on each heat pump module.
- Enhanced vapor injection scroll compressor on each refrigeration circuit each with crankcase heater, solid state overload protection and in-line circuit breaker. Vapor injection compressors provide greater heating performance in low ambient temperatures.
- Dual circuit, brazed plate heat exchanger in each heat pump module for use as an evaporator or condenser depending on the operating mode.
- Electronic valve and manual isolation valve on each heat exchanger for individual service isolation, to allow variable flow, to maximize leaving fluid temperature in reduced load condition (condenser operation) and to control head pressure (evaporator operation).
- Refrigeration reversing valve on each refrigeration circuit.
- 40 mesh strainer and thermal dispersion flow switch on heat exchanger branch line.
- Individual module servicing and strainer cleaning while balance of chiller system remains operational.
- Aluminum finned, copper tube air cooled coil for use as an evaporator or condenser while in heating mode or cooling mode respectively.
- ECM type, refrigeration pressure-controlled, variable speed fan/motor assemblies for quiet operation.
- Low voltage and high voltage electrical panel separation.
- Phase monitor for low voltage, phase imbalance, phase loss, and phase reversal on primary heat pump module.

AXM Modular Air-to-Water Heat Pump

- Standard 5 KAIC SCCR protection with option for 65 KAIC.
- Roll grooved connections on carbon steel schedule 10 pipe headers.
- 3/4-inch Insulation on each brazed plate heat exchanger, fluid piping, and components.
- Formed galvanized sheet metal frame powder coated with an oven baked finish.
- Powder coated steel sheet metal cabinet panels that are easily removable for servicing via stainless steel fasteners.
- Primary microprocessor controller provides current alarm status, alarm logging of the previous 2000 alarms, fluid temperatures for each module, refrigeration pressure on each refrigeration circuit, compressor run hours, current status display, remote on/off, general alarm contacts, and BMS connectivity.
- Distributed primary microprocessor on each secondary module allows each to continue operating should there be a failure of the primary microprocessor controller.
- A smart operator 7-inch touch screen graphical interface display inside the primary module electrical panel to allow operation and alarm monitoring, adjustment of user set points, and controlled temperatures trending.
- Cellular VPN router allows for optional remote internet monitoring, remote control, and access to operational logs and software updates.

General Data

Table 8. General data – Thermafit™ AXM air-to-water heat pump

Capacity (Tons)	30
General Unit	
Number of Independent Refrigeration Circuits	DUAL
Load Fluid Volume(gal/module)	18.44
Compressor	
Type	VAPOR INJECTED SCROLL
Quantity	2
Load Heat Exchanger	
Type	BRAZED PLATE
Quantity	1
Fluid Volume (gal)	2.24
Fouling Factor (hr ft ² -F/Btu)	0.0001
Number of Circuits	2
Heating - Minimum/Maximum Leaving Water Temperatures (°F)	90-140
Heating - Minimum/Maximum Leaving Brine Temperatures (°F)	90-140
Cooling - Minimum/Maximum Leaving Water Temperatures (°F)	42-65
Cooling - Minimum/Maximum Leaving Brine Temperatures (°F)	42-65
Minimum Water/Brine Operating Pressure (psig)	0
Maximum Water/Brine Operating Pressure (psig) Standard Option	200
Maximum Water/Brine Operating Pressure (psig) Hi Pressure Option	300
Fans	
Motor Type	EC
HP	4.35
Fan Type	AXIAL
Airflow (cfm/module)	23,000



AXM Modular Air-to-Water Heat Pump

Table 8. General data – Thermafit™ AXM air-to-water heat pump (continued)

Capacity (Tons)	30
Coils	
Fin Material	ALUMINUM
Fin/in (FPI)	12
Tube Material	COPPER
Tube Diameter (mm)	0.375 (9.5)
Number of Rows	4
Coil Dimensions (qty)	40" x 88" (2)

Unit Dimensions and Weights

Figure 6. AXM air-to-water heat pump 30 tons

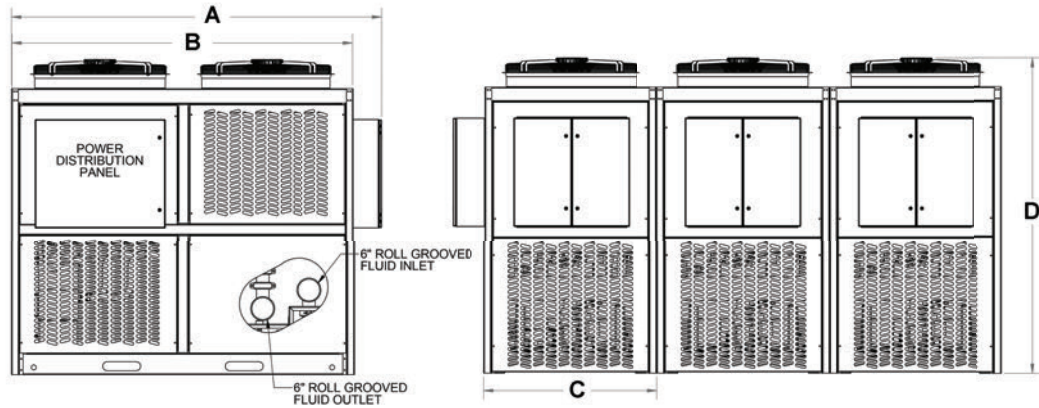
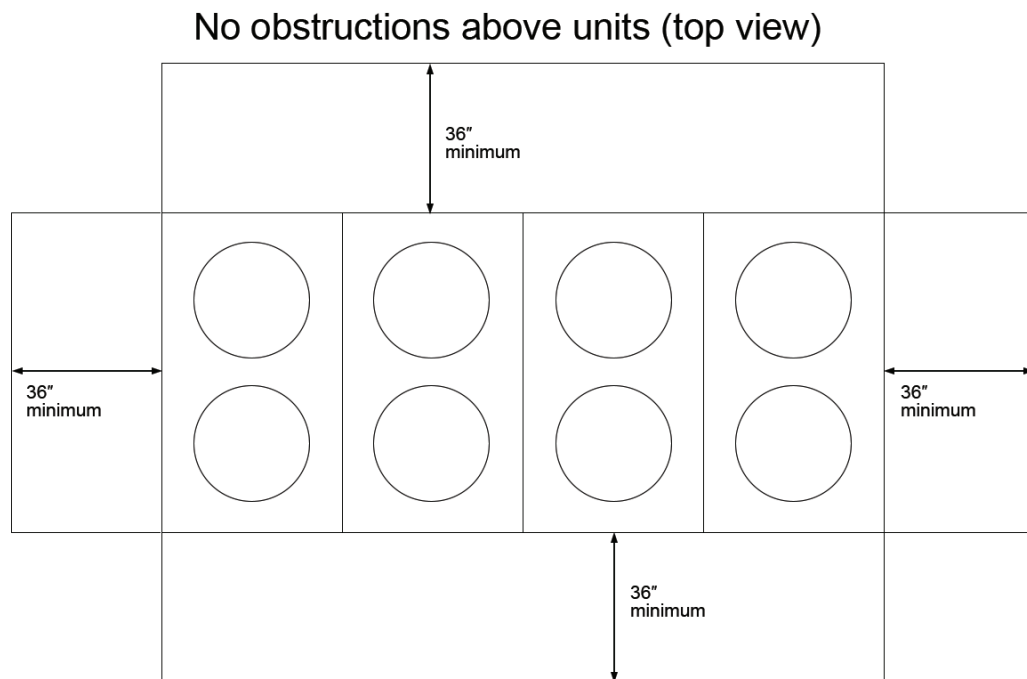

Table 9. Unit dimensions and weight - 30 tons (AXM)

Dim	Units	Unit Sizes and Weights Per Module
A	inch	103
B		95
C		48
D		90
Weight	lbs	3500

Service Clearance

Figure 7. AXM service clearance



NOTE: If unit is surrounded by a fence, the minimum clearance is 48 inches. The fence must allow 50% airflow.



WXM Modular Water-to-Water Heat Pump

- 20 to 80 nominal tons per module
- Maximum of 12 modules
- Up to 960 tons per chiller bank



Features and Benefits

- Dual R-454B refrigeration circuits on each heat pump module.
- Hermetic scroll compressor on each circuit with solid-state overload protection, and in-line circuit breaker.
- Dual circuit, brazed plate heat exchanger for use as evaporator or condenser in each chiller module.
- Fine mesh strainer on each heat exchanger branch line.
- Thermal dispersion flow switch on each heat exchanger branch line.
- Electronic modulating valve and manual isolation valve on each heat exchanger for individual service isolation, to allow variable flow, to maximize leaving fluid temperature in reduced load condition (condenser operation) and to control head pressure (condenser operation). Individual module servicing and strainer cleaning while balance of chiller system remains operational.
- Reversing valves on each refrigeration circuit.
- Phase monitor on the power supply to protect against low voltage, phase unbalance, phase loss, and phase reversal conditions.
- Carbon steel fluid headers with roll grooved connections.

WXM Modular Water-to-Water Heat Pump

- 3/4-inch Insulation on load heat exchanger, fluid piping, and components.
- Formed sheet metal frames, powder-coated with an oven-baked finish.
- Primary microprocessor controller provides current alarm status, alarm logging of the previous 2000 alarms, fluid temperatures for each module, refrigeration pressure on each refrigeration circuit, compressor run hours, current status display, remote on/off, general alarm contacts, and BMS connectivity.
- Distributed secondary microprocessor controller on each secondary module to allow continued operation should there be a failure of the primary microprocessor controller. (Only applicable when one or more secondary modules are required).
- 7-inch touchscreen graphical interface display installed on the primary module of the chiller system.
- Cellular VPN router allows for optional remote internet monitoring, remote control, and access to operational logs and software updates.

General Data

Table 10. General data - Thermafit™ WXM heat pump

Capacity (Tons)	20	25	30	40	50	60	80
General Unit							
Number of Independent Refrigeration Circuits	DUAL	DUAL	DUAL	DUAL	DUAL	DUAL	DUAL
Load Fluid Volume(gal/module)	6.9 ^(a)	8.9 ^(b)	9.2 ^(b)	13.4 ^(b)	14.6 ^(b)	17.5 ^(b)	20.7 ^(b) / 27.1 ^(c)
Source/Sink Fluid Volume (gal/module)	5.1 ^(a)	8.9 ^(b)	9.2 ^(b)	13.4 ^(b)	14.6 ^(b)	17.5 ^(b)	20.7 ^(b) / 27.1 ^(c)
Compressor							
Type	SCROLL	SCROLL	SCROLL	SCROLL	SCROLL	SCROLL	SCROLL
Quantity	2	2	2	2	2	2	2
Brazed Plate Heat Exchanger							
Type	BRAZED PLATE	BRAZED PLATE	BRAZED PLATE	BRAZED PLATE	BRAZED PLATE	BRAZED PLATE	BRAZED PLATE
Quantity	2	2	2	2	2	2	2
Fluid Volume (gal)	2.3	2.5	2.7	4.6	5.5	8.5	13.31
Minimum/Maximum Leaving Water Temperatures (°F)	42-65 / 90-140	42-65 / 90-140	42-65 / 90-140	42-65 / 90-140	42-65 / 90-140	42-65 / 90-140	42-65 / 90-140
Minimum/Maximum Leaving Water Temperatures (°C)	42-65 / 90-140	42-65 / 90-140	42-65 / 90-140	42-65 / 90-140	42-65 / 90-140	42-65 / 90-140	42-65 / 90-140
Fouling Factor (hr ft ² -F/Btu)	0.0001	0.0001	0.0001	0.0001	0.0001	0.0001	0.0001
Minimum Water/Brine Operating Pressure (psig)	0	0	0	0	0	0	0
Maximum Water/Brine Operating Pressure (psig) Standard Option	N/A	150	150	150	150	150	150
Maximum Water/Brine Operating Pressure (psig) Hi Pressure Option	N/A	300	300	300	300	300	300
Material (plates/brazing)	316 SST/CU	316 SST/CU	316 SST/CU	316 SST/CU	316 SST/CU	316 SST/CU	316 SST/CU

^(a) 4-inch pipe headers.

^(b) 6-inch pipe headers.

^(c) 8-inch pipe headers.



WXM Modular Water-to-Water Heat Pump

Unit Dimensions and Weights

Figure 8. WXM water-to-water heat pump modularity - 20 to 80 tons

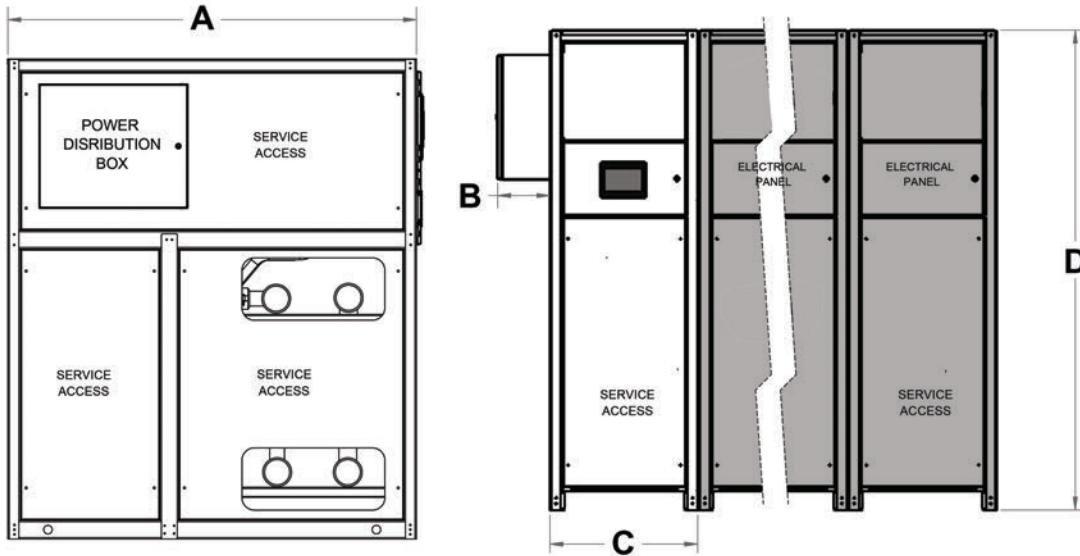
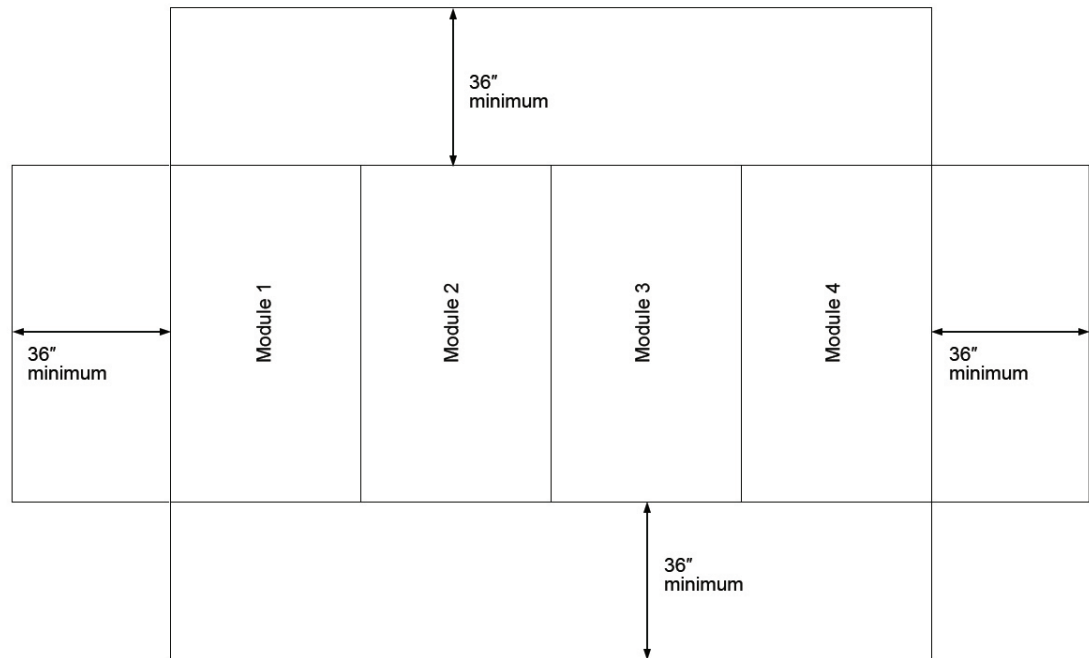

Table 11. General data - Thermafit™ WXM heat pump

Dim	Units	Unit Sizes and Weights Per Module						
		20 Tons	25 Tons	30 Tons	40 Tons	50 Tons	60 Tons	80 Tons
A	inch	66	66	66	66	66	66	79
B		8.5	8.5	8.5	8.5	8.5	8.5	8.5
C		24	24	24	34	34	34	42
D		77	77	77	77	77	77	80
Weight	lbs	1400	1500	1600	1800	1800	1900	2600

Service Clearance

Figure 9. WXM service clearance



NOTE: 48 inches minimum overhead clearance



MAS Modular Air-Source Multipipe

- 30 nominal tons per module
- Maximum of 12 modules
- Up to 300 tons per chiller bank



Features and Benefits

- Single R-454B refrigeration circuits on each multipipe module.
- Two vapor injection scroll compressors in a tandem compressor set on each module, each equipped with a crankcase heater, solid state overload protection and in-line circuit breaker. Vapor injection compressors provide greater heating performance in low ambient temperatures.
- Single circuit, stainless steel brazed plate evaporator for cooling fluid when there is a simultaneous heating and cooling demand or cooling only demand. The brazed plate evaporator and brazed plate condenser are used to cool and heat fluid during simultaneous heating and cooling mode. The air coil operates as a condenser during cooling mode when the brazed plate evaporator produces cold fluid when there is only a demand for cooling.
- Single circuit, independent cold and hot fluid brazed plate heat exchanger in each multipipe module for use as an evaporator or condenser depending on the operating mode.
- Single circuit, stainless steel brazed plate heat recovery condenser for heating fluid when there is a simultaneous heating and cooling demand or heating only demand. Refrigerant is diverted from air coil to this brazed plate condenser to reject heat during heating mode and the air coil operates as an evaporator when there is only a demand for heating.
- Fine mesh strainer and thermal dispersion flow switch on each brazed plate heat exchanger.
- Electronic modulating and manual valves on each brazed plate heat exchanger to allow for variable hot fluid flow as well as individual module hot and cold fluid isolation.
- Refrigeration actuated ball valves on each refrigeration circuit.

- Individual module servicing and strainer cleaning while balance of chiller system remains operational.
- Aluminum finned, copper tube air coil for use as an evaporator or condenser while in heating mode or cooling mode respectively.
- Refrigeration actuated ball valves on each refrigeration circuit.
- ECM type, refrigeration pressure-controlled, variable speed fan/motor assemblies for quiet operation.
- Low voltage and high voltage electrical panel separation.
- Phase monitor for low voltage, phase imbalance, phase loss, and phase reversal on primary heat pump module.
- Standard 5 kA SCCR protection with option for 65 kA SCCR.
- Roll grooved connections on carbon steel schedule 10 pipe headers.
- 3/4-inch Insulation on each brazed plate heat exchanger, fluid piping, and components.
- Formed galvanized sheet metal frame powder coated with an oven baked finish.
- Powder coated steel sheet metal cabinet panels that are easily removable for servicing via retaining clips.
- Primary microprocessor controller provides current alarm status, fluid temperatures for each module, refrigeration pressure on each refrigeration circuit, compressor run hours, current status display, remote on/off, general alarm contacts, and BMS connectivity.
- Distributed primary microprocessor on each secondary module allows each to continue operating should there be a failure of the primary microprocessor controller.
- A smart operator 7-inch touch screen graphical interface display inside the primary module electrical panel to allow operation, alarm monitoring and logging of the previous 2000 alarms, adjustment of user set points, and controlled temperatures trending.
- Cellular VPN router allows for optional remote internet monitoring, remote control, and access to operational logs and software updates.

General Data

Table 12. General data – Thermafit™ MAS air-source multipipe

Capacity (Nominal Tons)	30
Compressor	
Type	VAPOR INJECTED SCROLL
Quantity	1 TANDEM SET OF 2 COMPRESSORS
Fluid Volume (gal/module)	32.5
Load Heat Exchanger	
Type	BRAZED PLATE
Quantity	2
Fluid Volume (gal/BPHE)	3.45
Number of Circuits	1
Fans	
Motor Type	EC
HP	4.35
Fan Type	AXIAL
Air Flow (cfm/module)	23,000



MAS Modular Air-Source Multipipe

Table 12. General data – Thermafit™ MAS air-source multipipe (continued)

Capacity (Nominal Tons)	30
Air Coils	
Fin Material	ALUMINUM
Fin/in (FPI)	12
Tube Material	COPPER
Tube Diameter (mm)	0.375 (9.5)
Number of Rows	4
Coil Dimensions (qty)	40" x 88" (2)

Unit Dimensions and Weights

Figure 10. MAS air-source multipipe - 30 tons

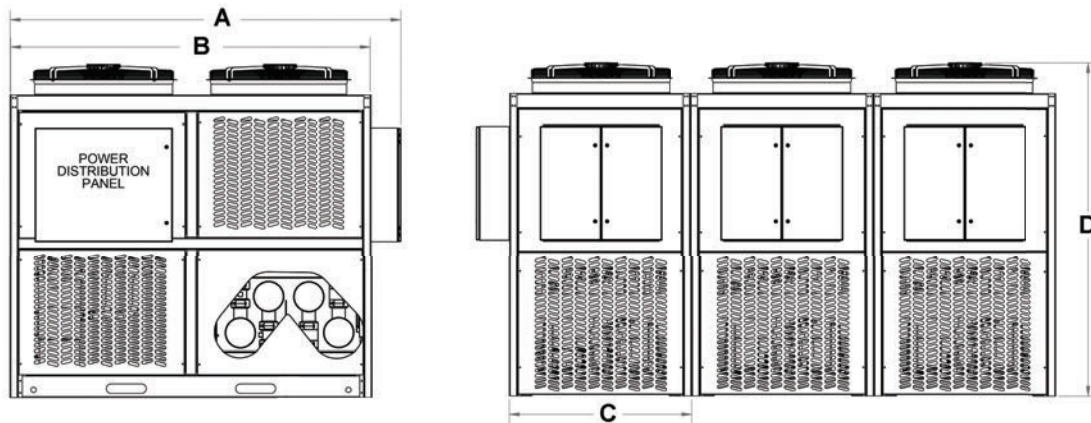
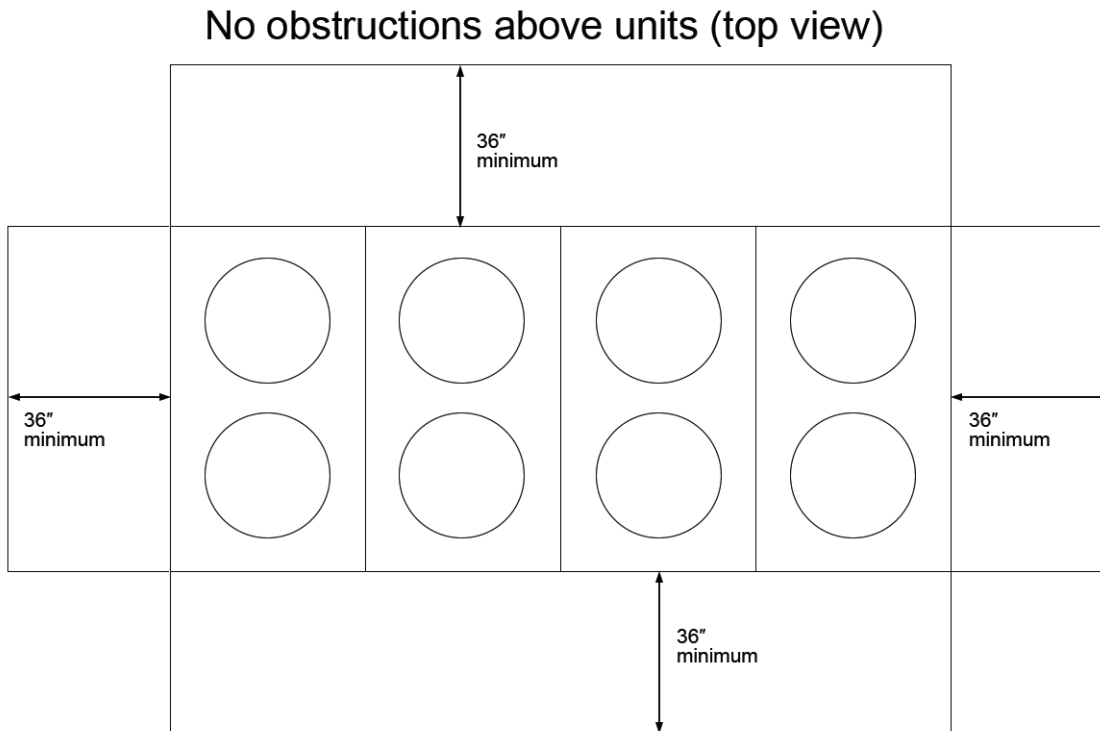

Table 13. Unit dimensions and weight - 30 tons (MAS)

Dim	Units	Unit Sizes and Weights Per Module
A	inch	103
B		95
C		48
D		90
Weight	lbs	~3000

Service Clearance

Figure 11. MAS service clearance



NOTE: If unit is surrounded by a fence, the minimum clearance is 48 inches. The fence must allow 50% airflow.



MWS Modular Water-Source Multipipe

- 30 to 60 nominal tons per module
- Maximum of 10 modules / Minimum of 3 modules
- Up to 600 tons per bank



Features and Benefits

- Single R-454B refrigerant circuit on each module.
- Hermetic scroll tandem compressor set with two fixed speed compressors, each tandem set with oil level sight glass, in-line circuit breaker, and solid-state overload protection.
- Six pipe system design provides hot and cold building load fluid using the chilled fluid supply and return piping, hot fluid supply and return piping and source/sink geothermal/cooling tower loop supply and return piping.
- Single circuit, brazed plate evaporator and condenser in each module.
- Fine mesh strainer on each evaporator, condenser, and source branch line piping.
- Thermal dispersion flow switch on each evaporator, condenser, and source branch line piping.
- Electronic and manual isolation valves on each evaporator and condenser branch line piping for service isolation and variable flow.
- Single circuit, stainless steel brazed plate heat exchanger in each module for source/sink fluid (geothermal or cooling tower) for rejecting (condenser operation) or absorbing (evaporator operation) heat to the fluid when there is no longer a hot or cold fluid requirement, respectively. The fluids in the source/sink loop and the load loops shall not mix.
- Electronic and manual valves on each source/sink loop heat exchanger to allow for head pressure control as well as individual isolation.

- Electronic expansion valve.
- Individual module servicing and strainer cleaning while balance of chiller system remains operational.
- 6-inch schedule 10 carbon steel cold load fluid evaporator and hot load fluid condenser (8-inch source/sink heat exchanger headers for 50 ton and 60 ton units).
- 8-inch schedule 10 carbon steel source/sink fluid evaporator and condenser.
- 3/4-inch insulation on each evaporator, condenser, fluid piping, and components.
- Formed sheet metal frames and panels powder-coated with an oven-baked finish.
- Primary microprocessor controller provides current alarm status, alarm logging, water temperatures for each module, refrigeration pressure, compressor run hours, current status display, remote on/off, general alarm contacts, and BMS connectivity.
- Distributed primary microprocessor controller on each secondary module to allow the secondary modules to continue to operate should there be a failure of the primary microprocessor controller.
- 7-inch touchscreen graphical interface display installed on the primary module of the chiller system.
- Phase monitor for low voltage, phase imbalance, phase loss, and phase reversal on primary heat pump module.
- Cellular VPN router allows for optional remote internet monitoring, remote control, and access to operational logs and software updates.

General Data

Table 14. General data – Thermafit™ MWS water-source multipipe

Capacity (Tons)	30	40	50	60
General Unit				
Refrigerant Type	R-454B	R-454B	R-454B	R-454B
Number of Independent Refrigeration Circuits	1	1	1	1
Fluid Volume (gal/module)	40.9	43.2	60.7	64.9
Compressor				
Type	TANDEM SCROLL	TANDEM SCROLL	TANDEM SCROLL	TANDEM SCROLL
Quantity	1 SET	1 SET	1 SET	1 SET
Evaporator^(a)				
Type	BRAZED PLATE	BRAZED PLATE	BRAZED PLATE	BRAZED PLATE
Quantity	1	1	1	1
Fluid Volume (gal)	3.4	4	5.2	6.6
Material	316 SST	316 SST	316 SST	316 SST
Condenser^(b)				
Type	BRAZED PLATE	BRAZED PLATE	BRAZED PLATE	BRAZED PLATE
Quantity	1	1	1	1
Fluid Volume (gal)	3.1	3.7	4.8	6.2
Material	316 SST	316 SST	316 SST	316 SST
Source/Sink Heat Exchanger^(c)				
Type	BRAZED PLATE	BRAZED PLATE	BRAZED PLATE	BRAZED PLATE
Quantity	1	1	1	1
Fluid Volume (gal)	3.4	4	5.2	6.6
Material	316 SST	316 SST	316 SST	316 SST

^(a) Evaporator Fouling Factor is 0.0001.

^(b) Condenser Fouling Factor is 0.00025.

^(c) Source Fouling Factor is 0.00025.



MWS Modular Water-Source Multipipe

Unit Dimensions and Weights

Figure 12. Dimensions and weight – Thermafit MWS (30 and 40 tons module)

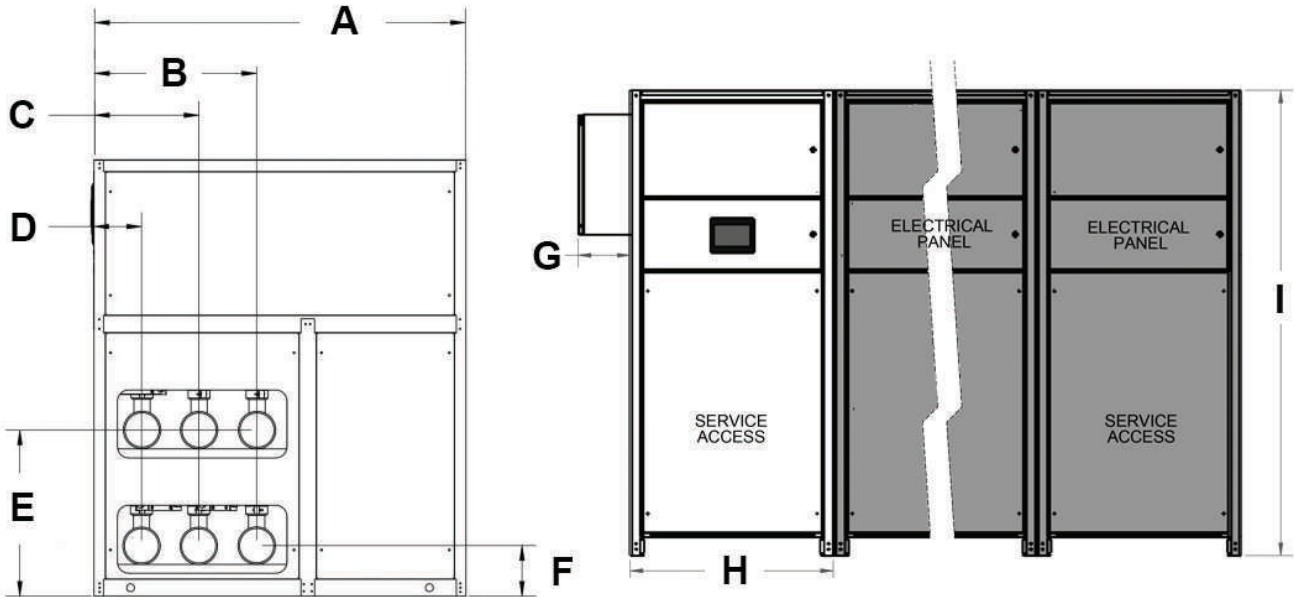

Table 15. Dimensions and weight – Thermafit MWS (30 and 40 tons module)

Dim	30 Tons	40 Tons
A	66	66
B	28.5	28.5
C	18.5	18.5
D	8.5	8.5
E	29	29
F	8.8	8.8
G	12	12
H	34	34
I	77	78
Wt (lbs)	1800	2000

Figure 13. Dimensions and weight – Thermafit MWS (50 and 60 tons module)

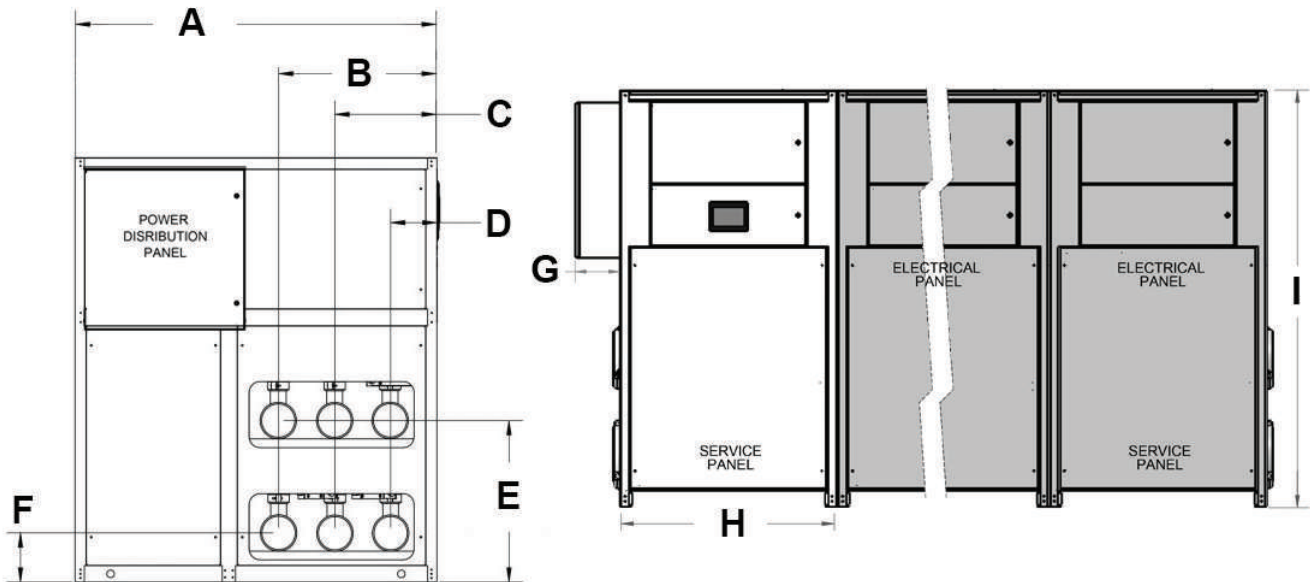

Table 16. Dimensions and weight – Thermafit MWS (50 and 60 tons module)

Dim	50 Tons	60 Tons
A	79	79
B	34.6	34.6
C	22	22
D	10	10
E	29 / 28.8 ^(a)	29 / 28.8 ^(a)
F	8.75 / 9.5 ^(a)	8.75 / 9.5 ^(a)
G	12	12
H	42	42
I	80	80
Wt (lbs)	2900	3100

^(a) Source header dimensions only. The 50 ton and 60 ton modules have 8-inch headers.

Service Clearance

Figure 14. MWS service clearance

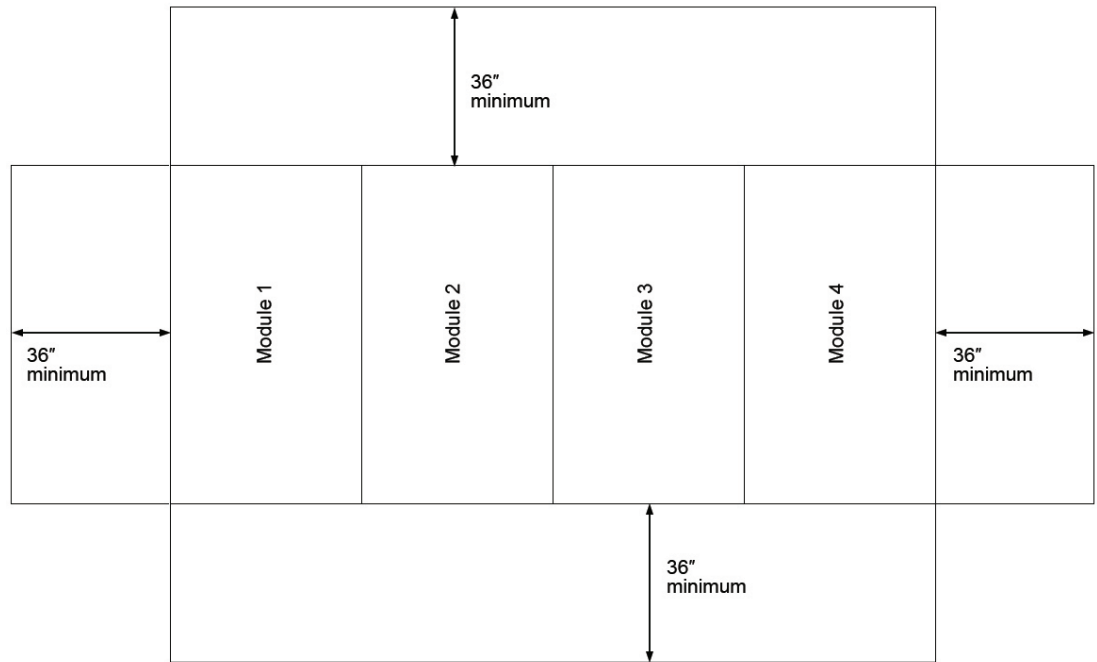

NOTE: 48 inches minimum overhead clearance



MAR Modular Split System with Remote Condenser

- 150 to 80 nominal tons per module
- Maximum of 12 modules
- Up to 960 tons per chiller bank



Features and Benefits

Chiller

- Dual R-454B refrigeration circuits on each chiller module.
- Hermetic scroll compressor on each refrigeration circuit each with oil level sight glass, solid state motor overload protection and in-line circuit breaker.
- Two stages of compressor capacity steps per chiller module.
- Dual circuit, brazed plate evaporator in each module.
- Integral flow switch and fine mesh strainer on each evaporator branch line.
- Manual isolation valves on each evaporator for service isolation.
- Refrigerant receiver on each refrigeration circuit.
- Replaceable core filter dryer on each refrigeration circuit.
- Two discharge and two liquid refrigerant lines on each module.
- 7-inch touchscreen graphical interface display installed on the primary module of the chiller system.
- Primary microprocessor controller provides current alarm status, alarm logging of the previous 2000 alarms, water temperatures for each module, refrigeration pressure on each refrigeration circuit, compressor run hours, current status display; remote on/off, general alarm contacts, and BMS connectivity.
- Distributed secondary microprocessor on each secondary module to allow each to continue operating should the primary microprocessor fail.
- Carbon steel headers with roll grooved connections.
- 3/4-inch closed cell insulation on the piping.



MAR Modular Split System with Remote Condenser

- White painted aluminum cabinet enclosure on an epoxy painted carbon steel frame.
- Split system chiller modules are shipped with a partial factory holding refrigerant charge. Full system refrigerant charge including the required refrigerant for the piping between the chiller modules and condenser must be provided and installed by the contractor.
- Cellular VPN router allows for optional remote internet monitoring, remote control, and access to operational logs and software updates.

Remote Air-Cooled Condenser

- Dual refrigeration circuits on each condenser.
- Fan cycling head pressure control for operation down to 20°F ambient.
- Independent power supply for each condenser.

General Data

Table 17. General data – Thermafit™ MAR split system with remote condenser

Capacity (Tons)	15	20	25	30	40	50	60	80
General Unit								
Number of Independent Refrigeration Circuits	DUAL	DUAL	DUAL	DUAL	DUAL	DUAL	DUAL	DUAL
Chilled Fluid Volume(gal/module)	6.5 ^(a)	6.9 ^(a)	8.9 ^(b)	9.2 ^(b)	13.4 ^(b)	14.6 ^(b)	17.5 ^(b)	20.7 ^(b) / 27.1 ^(c)
Compressor								
Type	SCROLL	SCROLL	SCROLL	SCROLL	SCROLL	SCROLL	SCROLL	SCROLL
Quantity	2	2	2	2	2	2	2	2
Evaporator								
Type	BRAZED PLATE	BRAZED PLATE	BRAZED PLATE	BRAZED PLATE	BRAZED PLATE	BRAZED PLATE	BRAZED PLATE	BRAZED PLATE
Quantity	1	1	1	1	1	1	1	1
Fluid Volume (gal)	1.4	1.8	2.3	2.5	4	5	7.5	7.2
Fouling Factor (hr ft ² -F/Btu)	0.0001	0.0001	0.0001	0.0001	0.0001	0.0001	0.0001	0.0001
Material (plates/brazing)	316 SST/CU	316 SST/CU	316 SST/CU	316 SST/CU	316 SST/CU	316 SST/CU	316 SST/CU	316 SST/CU
Remote Condenser Fans								
Motor Type	EC	EC	EC	EC	EC	EC	EC	EC
HP	1.5	1.5	1.5	1.5	1.5	1.5	1.5	1.5
Number of Fans	2	2	2	2	3	4	4	6
Fan Configuration	1x2	1x2	1x2	1x2	1x3	2x2	2x2	2x3
Fan Type	AXIAL	AXIAL	AXIAL	AXIAL	AXIAL	AXIAL	AXIAL	AXIAL
Fan Material	ALUMINUM SHEET INSERT, SPRAYED WITH PP PLASTIC							
Air Flow (cfm/module)	24000	23000	22500	23000	34000	46000	45000	65000
Condenser Coils								
Fin Material	ALUM	ALUM	ALUM	ALUM	ALUM	ALUM	ALUM	ALUM
Fin/in (FPI)	10	10	10	10	10	10	10	10
Tube Material	COPPER	COPPER	COPPER	COPPER	COPPER	COPPER	COPPER	COPPER

^(a) 4-inch pipe headers.

^(b) 6-inch pipe headers.

^(c) 8-inch pipe headers.

Unit Dimensions and Weights

Figure 15. MAR air-cooled split system with remote condenser – 15 to 30 tons

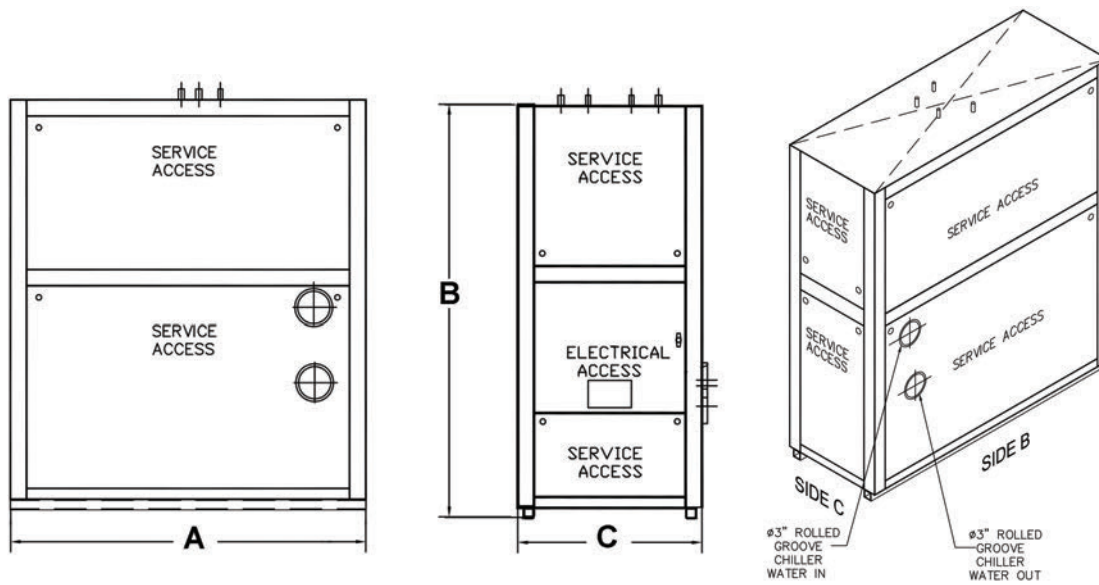

Table 18. Unit dimensions and weight – 15 to 30 tons (MAR)

Dim	Units	Unit Sizes and Weights Per Module			
		15 Tons	20 Tons	25 Tons	30 Tons
A	Inch	66	66	66	66
B		77	77	77	77
C		24	24	24	24
Weight	lbs	1400	1400	1500	1600
		Unit Sizes and Weights Per Remote Condenser			
Dimensions	Inch	49(W)/139(L)/54.5(H)	49(W)/139(L)/54.5(H)	49(W)/139(L)/54.5(H)	49(W)/139(L)/54.5(H)
Weights	lbs	710	710	830	870



MAR Modular Split System with Remote Condenser

Figure 16. MAR air-cooled split system with remote condenser – 40 to 80 tons

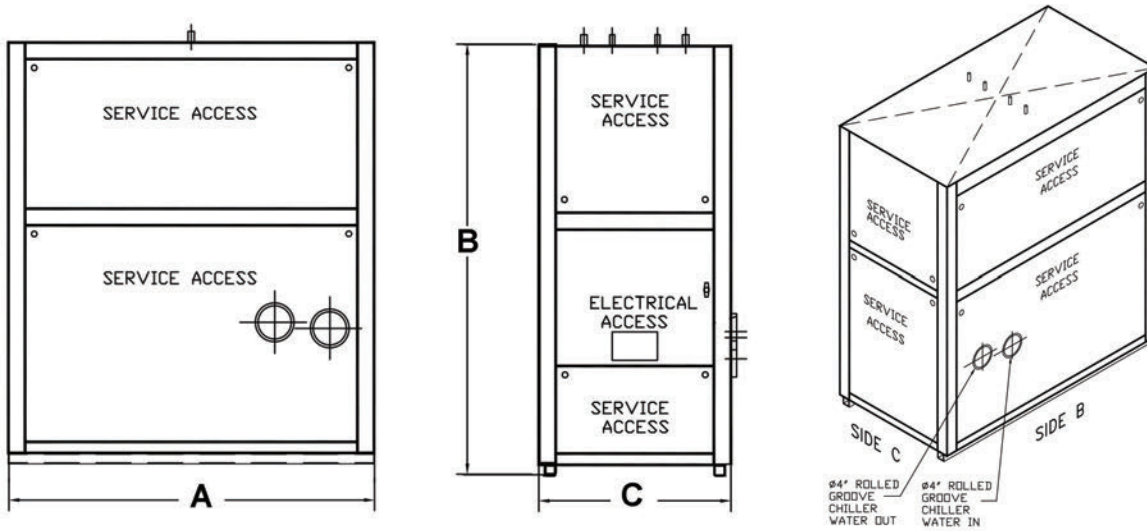
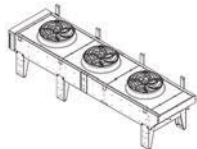
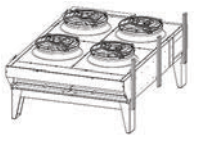

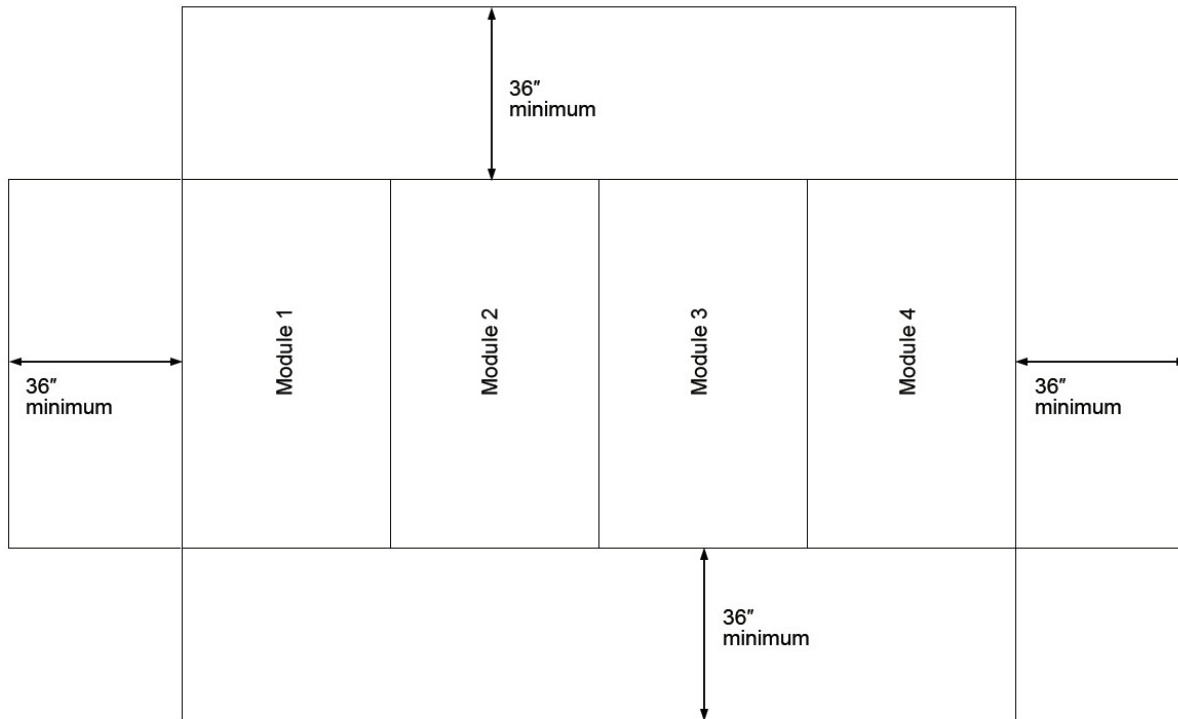

Table 19. Unit dimensions and weight – 40 to 80 tons (MAR)

Dim	Units	Unit Sizes and Weights Per Module			
		40 Tons	50 Tons	60 Tons	80 Tons
A	Inch	66	66	66	79
B		77	77	77	80
C		34	34	34	42
Weight	lbs	2200	2400	2600	2800
		Unit Sizes and Weights Per Remote Condenser			
					
Dimensions	Inch	49(W)/197(L)/54.5(H)	92(W)/139(L)/54.5(H)	92(W)/139(L)/54.5(H)	92(W)/255(L)/54.5(H)
Weights	lbs	1250	1540	1615	2100

Service Clearance

Figure 17. MAR Service clearance (indoor equipment)



NOTE: 48 inches minimum overhead clearance



TACW Modular Magnetic Bearing Water-Cooled Centrifugal Chiller

- 65 to 135 nominal tons per module
- Maximum of 8 modules
- Up to 1080 tons per chiller bank



Features and Benefits

- ETL and AHRI certified.
- 65 kA SCCR rating.
- One TTS300 or TTS400 Danfoss Turbocor variable speed, magnetic bearing, oil-free centrifugal compressor.
- Unprecedented part-load performance, high energy efficiency, and quiet operation.
- 5 percent line reactor per compressor.
- Mounted fused isolation switch per compressor.
- On/Off motorized isolation valve on evaporator and condenser water side.
- Refrigerant isolation valves located around all serviceable components.
- Dual manifold pressure relief valves on condenser and evaporator.
- Danfoss Turbocor MCX controller complete with 7-inch Schneider HMI (colored monitor).
- Cellular VPN router allows for optional remote internet monitoring, remote control, and access to operational logs and software updates.
- Bacnet®/LONWORKS®/ModBus™ included.
- Flooded shell and tube evaporator and condenser.

TACW Modular Magnetic Bearing Water-Cooled Centrifugal Chiller

- ASME/CRN Certified cleanable flooded Shell and Tube condenser, with standard 150psi design pressure design pressure water side.
- Flow switch located at evaporator and condenser hydronic outlet.
- Electronic expansion valve per circuit providing precise PLC controlled refrigerant flow.
- 3/4-inch (19mm) closed-cell insulation.
- First year parts, refrigerant, and labor warranty.

General Data

Table 20. General data - Thermafit TACW modular chiller

Capacity (Tons)	TACW085 (65 to 90)	TACW125 (90 to 135)
General Unit		
Number of Independent Refrigeration Circuits	SINGLE	SINGLE
Chilled Fluid Volume(gal/module) (w/headers) ^(a)	37.3	37.3
Condenser Fluid Volume (gal/module) (w/headers) ^(a)	42.6	42.6
Compressor		
Type	CENTRIFUGAL	CENTRIFUGAL
Quantity	1	1
Evaporator		
Type	SHELL AND TUBE	SHELL AND TUBE
Quantity	1	1
Fluid Volume (gal)	17.2	17.2
Material (tubes/shell)	COPPER/STEEL	COPPER/STEEL
Condenser		
Type	SHELL AND TUBE	SHELL AND TUBE
Quantity	1	1
Fluid Volume (gal)	22.5	22.5
Material (tubes/shell)	COPPER/STEEL	COPPER/STEEL

^(a) Header sizes: for flow range up to 1400 gpm - 8-inch header size; for flow range 1400 gpm or higher - 10-inch header size.



TACW Modular Magnetic Bearing Water-Cooled Centrifugal Chiller

Unit Dimensions and Weights

Figure 18. TACW water-cooled modulares – 65 to 135 tons

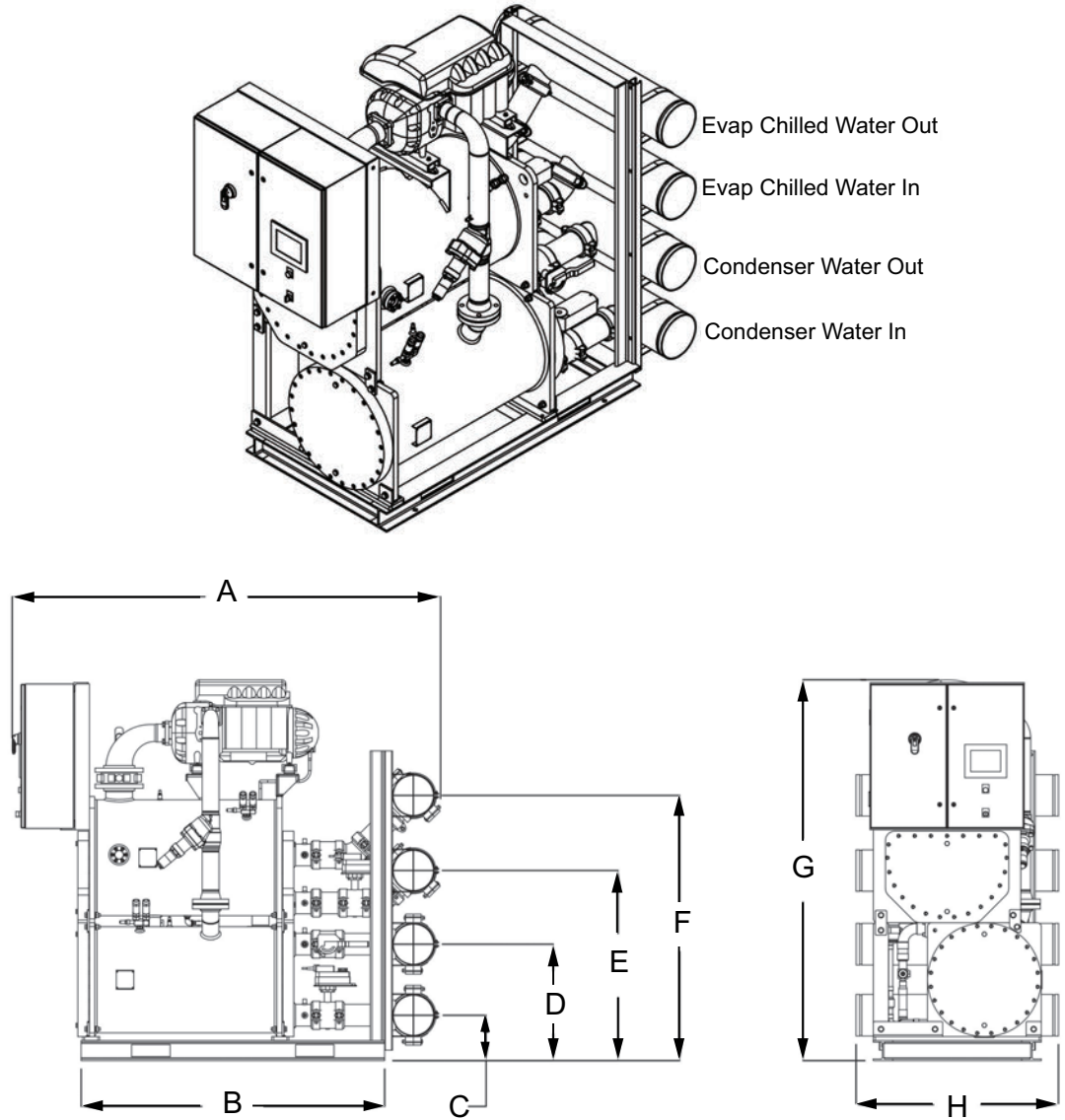

TACW Modular Magnetic Bearing Water-Cooled Centrifugal Chiller

Table 21. Unit dimensions and weight – 65 to 135 tons (TACW)

Dim	Units	Unit Sizes and Weights Per Module for 8-in. Headers		Unit Sizes and Weights Per Module for 10-in. Headers	
		65 to 90 Tons	90 to 135 Tons	65 to 90 Tons	90 to 135 Tons
A	inch	88.875	88.875	92	92
B		63	63	63	63
C		9.375	9.375	9.5	9.5
D		24.125	24.125	24.5	24.5
E		39.375	39.375	48.5	48.5
F		55	55	56	56
G		78.875	78.875	78.875	78.875
H		42	42	42	42
Shipping Weight ^(a)	lbs	4900	4900	4900	4900

^(a) For operating weights, add 700lbs to shipping weight.

Service Clearance

Figure 19. TACW service clearance

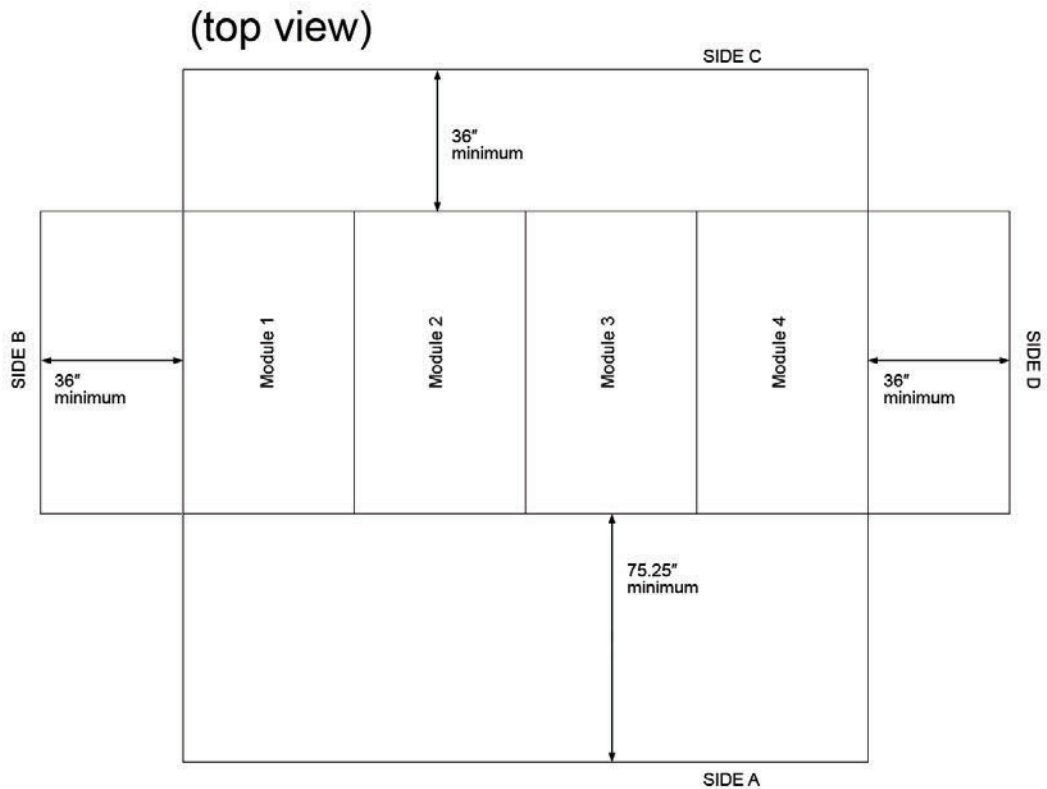

NOTE: 36 inches minimum overhead clearance

Controls

Note: These sections do not apply to the TACW model.

Carel c.pCO OEM Controller

Thermafit™ modular scroll compressor models use Carel c.pCO series controllers to monitor and report critical operating parameters. A primary controller is used to control and coordinate the functioning of all the modules that make up the chiller/heat pump system. For units consisting of more than a single module, each module has its own controller.

Primary/Secondary Operation

The distributed control system enables all secondary modules to operate independently in the event that the primary controller fails. All chiller/heat pump safeties including temperature setpoint, refrigerant pressures, and freeze protection are preserved. In a normal configuration, a secondary controller controls the single module to which it is dedicated. The secondary controller monitors key performance parameters for its module and sends real-time information to the primary controller. The primary controller monitors the performance of the modular chiller/heat pump system, activating and deactivating modules as needed to maintain the leaving water temperature for the chiller/heat pump.

Stand-Alone Operation

Besides running as a primary/secondary, modules can also operate in stand-alone mode. Any or each module switches to stand-alone mode if the system-controlled cooling and/or heating temperature sensor has failed or if the primary/secondary communication has been lost. When in **stand-alone mode**, each module runs independently and controls cooling and/or heating temperature based on its local temperature sensors. Stand-alone is fail-safe mode rather than an intended mode. Thus, modules will operate temporarily in this mode until normal primary/ secondary operation is recovered.

Typical Controller Network

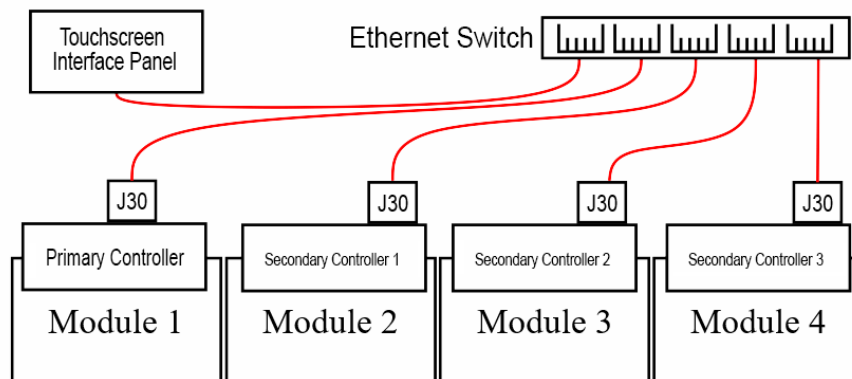

Controller Functions

All essential control information and operator actions are read and responded to using the touchscreen interface panel. The touchscreen communicates to primary and each secondary controllers and provides access to the following parameters, setpoints and alarms:

- Adjustable fluid temperature setpoint
- Multiple stage compressor control, including compressor rotation to provide even compressor usage and wear.
- High and low fluid temperature alarm setpoints
- Water inlet and outlet temperature
- Suction and discharge refrigeration pressures

- Compressor run status
- Current alarm status
- Alarm logging
- Demand load
- Compressor run hours
- Remote start stop input
- Dry contact for general alarm

Controller Key Features

Fast Data Exchange

Ethernet-based communication between c.pCOs and HMI allows for a fast data exchange and instantaneous touchscreen-to-c.pCO response (less than 0.5 seconds).

Temperature Reset Logic

Temperature Reset logic allows the system to adapt to load variation by automatically adjusting temperature setpoint based on the amount of load.

Variable Speed Compressor

Variable speed compressor applications allow for uninterrupted compressor operation at low loads, therefore, excessive compressor on/off cycling is avoided to ensure smooth temperature control.

EXOR eSmart07 Touch-Screen HMI

The standard EXOR eSmart touch-screen interface panel provided with the Carel c.pCO controller features a 7-inch touch-screen, allowing access to all operational inputs and outputs. The interface screen is the primary means for the operator that allows to monitor and modify functions involving temperatures, pressures, set points, alarms, operating schedules, and elapsed operating hours.

HMI Key Features

- 7-inch TFT color display, dimmable LED backlight
- Pixel (WVGA) resolution, 64K colors
- Resistive touchscreen
- Alarm logging of the previous 2000 alarms with time and date of each occurrence
- Chiller/Heat Pump bank setpoints can be saved and restored in one click
- Ethernet port
- USB port

HMI Operator Control

The touchscreen interface panel is ready to use when it is connected to the Ethernet switch and chiller/heat pump power is on. This touchscreen interface panel can be located within proximity of the primary controller. When connected to the Ethernet switch, the touchscreen interface panel displays current, real-time, information about the chiller/heat pump, as well as the status of critical parameters within each module of the system.

Optional Remote Monitoring

This option allows a user to perform remote management and monitor and adjust on-site operation data such as pressures, temperatures, time delays, alarm and fault information, trending, troubleshooting, preventive maintenance, and data analysis.



Danfoss MCX OEM Controller

Note: These sections apply only to the TACW model.

Thermafit™ TACW modular models use Danfoss MCX series controllers to monitor and report critical operating parameters. A primary controller is used to control and coordinate the functioning of all the modules that make up the chiller unit. For units consisting of more than a single chiller, each module has its own controller and touchscreen.

Primary/Secondary Operation

The distributed control system enables all secondary modules to operate independently. In the event that the primary controller fails, the next controller in line takes over as primary. All chiller safeties including temperature setpoint, refrigerant pressures, and freeze protection are preserved. In a normal configuration, a secondary controller controls the single module to which it is dedicated. The secondary controller monitors key performance parameters for its module and sends real-time information to the primary controller. The primary controller monitors the performance of the modular chiller system, activating and deactivating modules as needed to maintain the leaving water temperature for the chiller.

Stand-Alone Operation

Besides running as a primary/secondary, modules can also operate in stand-alone mode. Any or each module switches to stand-alone mode if the system-controlled cooling and/or heating temperature sensor has failed or if the primary/secondary communication has been lost. When in **stand-alone mode**, each module runs independently and controls cooling and/or heating temperature based on its local temperature sensors.

Typical Controller Network

The touchscreen interface is connected to and communicates with each module's controller via the Ethernet and RS485 switch. It accesses overall chiller functions and settings as well as individual module settings.

Controller Functions

All essential control information and operator actions are read and responded to using the touchscreen interface panel. The touchscreen interface panel is connected to the primary and companion controllers. The controller provides the following minimum functions and alarms:

- Adjustable fluid temperature setpoint
- Multiple stage compressor control, including compressor rotation to provide even compressor usage and wear.
- Low fluid temperature alarm setpoints
- Water inlet and outlet temperature
- Suction and discharge refrigeration pressures
- Compressor run status
- Current alarm status
- Alarm logging
- Capacity (%)
- Compressor run hours
- Remote start stop input
- Dry contact for general alarm

Controller Key Features

Programmability

Fully programmable product range in standard C++ language and Graphical programming tool.

Connection to the CANbus Local Network

Built-in CANbus interface as fieldbus to exchange information between controllers and accessories.

Modbus RS485 Serial Interfaces

Available with built-in RS485 Modbus network communication: Integration with Building Management System via Modbus directly.

Schneider 7-inch HMI Touchscreen

The Schneider interface panel provided with the Danfoss MCX controller features a 7-inch touchscreen, allowing access to all operational inputs and outputs. The interface screen is the primary means for the operator that allows to monitor and modify functions involving temperatures, pressures, setpoints, alarms, and elapsed operating hours.

HMI Key Features

- 7-inch TFT color display, backlit LCD
- 800 x 480-pixel (VGA) resolution, 65K colors
- Resistive touchscreen
- 96 MB memory capacity
- Ethernet port
- 2 USB ports

HMI Operator Control

The touchscreen interface panel is ready to use when it is connected to the Ethernet switch and chiller power is on. This touchscreen interface is located on the control panel of each module. When connected to the Ethernet switch, the touchscreen interface panel displays current, real-time, information about the chiller, as well as the status of critical parameters within each module of the chiller.

Optional Remote Monitoring

This option allows a user to perform remote management and monitor and adjust on-site operation data such as pressures, temperatures, time delays, alarm and fault information, trending, troubleshooting, preventive maintenance, and data analysis.

Building Management System (BMS)

The chiller can communicate with the building management systems, which include flexible control for chiller plants. These building management systems can control the operation of all functions of the control system including chiller enable/disable; compressor run status; pump controls; system evaporator and condenser temperatures; review and resetting of all non-active faults; interrogation and display of all sensor faults. Trane can undertake full responsibility for optimized automation and energy management for the entire chiller plant.

There are several BMS communication options:

- Modbus™ RTU
- Modbus IP
- BACnet® MS/TP
- BACnet® IP
- BACnet Ethernet
- LonWorks
- N2 Metasys



Mechanical Specifications

General

Trane Thermafit™ modular chiller/heat pump systems consist of individual modules that are assembled on site. Each module is completely factory wired and tested prior to shipment. Each module includes compressor(s), heat exchanger(s), air-cooled condenser (air-cooled modules only), and controls. Controls are designed on a distributed primary control system that allows the primary controller to operate remaining secondary modules in the event of a malfunction of any secondary controller. The controls are also designed to allow each individual secondary controller to operate on its own temperature sensor if there is a failure of the primary controller.

Refrigeration Circuits

Note: This section applies only to AMC, MAR, MWC, and WXM Models.

These chillers/heat pump use dual independent refrigeration circuits in each module using hermetically sealed scroll compressors each with oil level sight glass, suction gas-cooled motor with solid-state sensors in the windings for overload protection, and circuit breaker protection. There are two independent compressors and refrigerant circuits per module. Compressors are mounted to the formed sheet metal frame with rubber-in-shear vibration isolators.

Note: This section applies only to AXM model.

An enhanced vapor injection compressor is provided on each refrigeration circuit for greater heating performance in low ambient temperatures.

Dual independent refrigeration circuits provided in each module each with oil level sight glass, suction gas-cooled motor with solid-state sensors in the windings for overload protection, and circuit breaker protection. There are two independent compressors and refrigerant circuits per module. Compressors are mounted to the formed sheet metal frame with rubber-in-shear vibration isolators.

Note: This section applies only to MWS model.

The Thermafit™ MWS uses a single circuit tandem set of fixed speed scroll compressors in each module each with oil level sight glass, suction gas-cooled motor with solid-state sensors in the windings for overload protection, and circuit breaker protection. There is one compressor set and refrigerant circuit per module. Compressors are mounted to the formed sheet metal frame with rubber-in-shear vibration isolators.

Note: This section applies only to MAS model.

An enhanced vapor injection compressor is provided on the refrigeration circuit for greater heating performance in low ambient temperatures.

Single circuit, independent cold and hot fluid brazed plate heat exchanger is provided in each module each with oil level sight glass, suction gas-cooled motor with solid-state sensors in the windings for overload protection, and circuit breaker protection. There is a dual tandem compressor set in each module. Compressors are mounted to the formed sheet metal frame with rubber-in-shear vibration isolators.

Note: This section applies only to TACW model.

The Thermafit TACW modular chillers utilize independent refrigeration circuits using Turbocor compressors and flooded shell and tube evaporators and condensers.

Evaporator

Note: This section applies only to AMC, MAR, and MWC models.

The Thermafit™ chillers use a dual circuit, brazed plate evaporator on each module constructed of 316 stainless steel plates and copper brazing. The supply and return fluid piping connections to each evaporator include an electronic and a manual isolation valve to allow servicing of each module

individually while the remaining modules continue to operate, and to allow for variable flow. The fluid connections to each evaporator use roll grooved couplings for service convenience and ease of installation. Each evaporator is insulated with ¾ inch closed cell insulation. The maximum working pressure is 650 psi. Evaporator piping fluid velocity cannot exceed 10 fps at any point in the system.

Brazed Plate Heat Exchanger

Note: This section applies only to AXM and WXM models.

The Thermafit™ heat pumps use dual circuit, brazed plate heat exchangers that function as an evaporator or condenser depending on the operational mode. They are constructed of 316 stainless steel plates and copper brazing. The supply and return fluid piping connections to each brazed plate heat exchanger include an electronic and a manual isolation valve to allow servicing of each module individually while the remaining modules continue to operate, and to allow for variable flow. The fluid connections to each heat exchanger use roll grooved couplings for service convenience and ease of installation. Each heat exchanger is insulated with ¾ inch closed cell insulation. The maximum working pressure is 650 psi. Heat exchanger piping fluid velocity cannot exceed 10 fps at any point in the system.

Note: This section applies only to MAS model.

The Thermafit MAS uses two single circuit, brazed plate heat exchangers that function as an evaporator or condenser depending on the operational mode. They are constructed of 316 stainless steel plates and copper brazing and is insulated with ¾" closed cell insulation. The supply and return fluid piping from each heat exchanger includes a manual and an electronic valve for servicing each module individually while the remaining modules continue to operate, to allow for variable flow. The fluid connections to each heat exchanger use roll-grooved couplings for service convenience and ease of installation.

Note: This section applies only to MWS model.

The Thermafit MWS uses three single circuit, brazed plate heat exchangers that function as an evaporator, condenser, or both depending on the operational mode. They are constructed of 316 stainless steel plates and copper brazing and is insulated with ¾" closed cell insulation. The supply and return fluid piping from each evaporator, condenser, and source/sink heat exchanger includes a manual and an electronic valve for servicing each module individually while the remaining modules continue to operate, to allow for variable flow and, on each source/sink heat exchanger operating as a condenser, to control refrigeration head pressure. The fluid connections to each heat exchanger use roll-grooved couplings for service convenience and ease of installation.

Flooded Shell and Tube Evaporator/Condenser

Note: This section applies only to TACW model.

The refrigeration cycle of the Thermafit™ TACW makes use of a flooded shell-and-tube design with refrigerant evaporating on the shell side and water flowing inside tubes having enhanced surfaces.

Condenser and Fans

Note: This section applies only to AMC and MAR models.

The air-cooled condenser coils have aluminum fins mechanically bonded to copper tubes with integral subcooling circuits. The coils are sized to provide full heat of rejection at a maximum 25°F temperature difference between the condensing temperature and ambient air temperature at jobsite elevation above sea level. The coils are factory tested to a minimum of 600 psig.

The condenser fan motors are maintenance free, highly efficient Electronically Commutated Motors (ECM) with energy reduction capabilities of up to 35%. The fan motors vary speed to maintain the refrigeration head pressure.



Air Coils and Fans

Note: This section applies only to AXM and MAS models.

The air coils have aluminum fins mechanically bonded to copper tubes that functions as an evaporator or condenser depending on the operational mode. The coils are factory tested to a minimum of 600 psig.

The air coil fan motors are maintenance free, highly efficient Electronically Commutated Motors (ECM) with energy reduction capabilities of up to 35%. The fan motors vary speed to maintain the refrigeration head pressure.

Compressor

Note: This section applies only to AMC, MAR, MWC, and WXM models.

The Thermafit chillers/heat pumps use a hermetically sealed, scroll compressor on each refrigeration circuit. The Copeland scroll compressor is a state-of-the-art compressor with relay and overload monitoring capabilities designed to accommodate liquids (both oil and refrigerant) without causing compressor damage.

For select models, the Copeland compressor uses CoreSense technology as a sensor to unlock advanced capabilities such as protection, diagnostics, communication, and verification. Technicians can make faster, more accurate decisions resulting in improved compressor performance and reliability.

Note: This section applies only to AXM model.

An enhanced vapor injection scroll compressor is provided on each refrigeration circuit for greater heating performance in low ambient temperatures.

For select models, the Copeland compressor uses CoreSense technology as a sensor to unlock advanced capabilities such as protection, diagnostics, communication, and verification. Technicians can make faster, more accurate decisions resulting in improved compressor performance and reliability.

Note: This section applies only to MAS model.

An enhanced vapor injection scroll compressor in a tandem set is provided on a single refrigeration circuit for greater heating performance in low ambient temperatures.

For select models, the Copeland compressor uses CoreSense technology as a sensor to unlock advanced capabilities such as protection, diagnostics, communication, and verification. Technicians can make faster, more accurate decisions resulting in improved compressor performance and reliability.

Note: This section applies only to MWS model.

Scroll compressor in a tandem set is provided on a single refrigeration circuit.

For select models, the Copeland compressor uses CoreSense technology as a sensor to unlock advanced capabilities such as protection, diagnostics, communication, and verification. Technicians can make faster, more accurate decisions resulting in improved compressor performance and reliability.

Note: This section applies only to TACW model.

The compressor is a two-stage oil-free variable speed centrifugal magnetic bearing type. The magnetic bearings allow the compressor to operate without the use of oil for lubrication, which reduces energy losses due to friction and increases the heat transfer efficiency of the chiller. A variable speed drive on the motor allows the compressor to operate much more efficiently at partial loads.

Unit Controls

The primary chiller module incorporates the primary controller. The primary controller communicates with the remaining secondary controllers in each module via a local network communications protocol. The primary controller may include a phase monitor to protect against low voltage, phase unbalance, phase loss, and phase reversal conditions. The primary controller reads all analog and fault port values from all secondary module controllers and pass these values to the Building Automation System via BACnet®, Modbus™ or LONWORKS® protocols.

Note: *Additionally, each TACW module has its own BMS interface. Chiller bank can be controlled either way.*

Each chiller/heat pump control system may include operational switches for each compressor; high- and low-pressure transmitters to provide indication of refrigeration pressures in each circuit; high and low refrigeration pressure alarms including shutting shut down the faulty compressor(s); anti-short cycling compressor timers; minimum compressor run timers; connection to Building Automation System (if required).



Options

Application Options

Heat Recovery Operation

Note: This section applies only to AMC, MAS, MWC, and MWS models.

The modular heat recovery chiller system is equipped with a brazed plate condenser in each module each with, a thermal dispersion flow switch plus valves and controls for heat recovery operation.

Shell and Tube Evaporator

Note: This section applies only to the MAR model.

A shell and tube evaporator design constructed with carbon steel shells and copper tubes can be provided in lieu of the brazed plate heat exchanger.

The evaporator is designed, tested, and stamped in accordance with the ASME Boiler and Pressure Vessel Code for a refrigerant side working pressure of 200 psig. The evaporator is designed for a water side working pressure of 150 psig. Standard water connections are grooved for Victaulic style pipe couplings.

Shell and Tube Condenser

Note: This section applies only to MWC model.

A dual circuit compact shell and tube condenser can be included in each module in lieu of the standard brazed plate condenser. Their low susceptibility to fouling and the ability for the condenser tubes to be cleaned make the shell and tube heat exchangers ideal for applications where the fluid quality is poor. The shell is made of carbon steel and the tubes is copper with fluid flowing through the tubes and refrigerant through the shell. If the entering condenser fluid is below 65° F, an electronic modulating valve shall be provided for condenser head pressure control. The fluid connections to each condenser use roll grooved couplings and neoprene gaskets, for service convenience and ease of installation. Condenser piping fluid velocity shall not exceed 10 fps.

Double Wall Condenser

Note: This section applies only to MWC model.

Single circuit, double wall, brazed plate condenser on each refrigeration circuit to heat domestic/potable water. The condensers are built with 316 stainless steel plates and brazed with copper and include a vented port design to eliminate any cross contamination between the chiller refrigerant and the domestic water. The condensers are UL listed and approved for domestic water.

Variable Speed Drive

Note: This section applies only to AMC, MAR, MWC, and WXM models.

The lead chiller module or all chiller modules can have a variable speed drive (VSD) on the lead scroll compressor and standard scroll compressor on the lag circuit. The VSD scroll compressor provides smooth and efficient operation from 45 Hz to 60 Hz for close temperature control. This part load operation lowers the compressor condensing temperatures thereby lowering power consumption during variable load or low cooling load demands.

Electronic Isolation Valve

Note: This section applies only to AMC, MAR, and MWC models. Electronic isolation valves come standard on the AXM, MWS, and WXM models.

Each evaporator branch line includes a manual inlet and an electronic discharge butterfly valve that only allows system flow to each active module to match the cooling requirements of the system. By isolating individual modules that are not operating, the hydronic system can have variable primary flow. The valves are the slow opening type to minimize the sudden change in flow to the previously active modules. The valves have a minimum opening cycle time of 90 seconds between the fully closed and open position and have roll grooved connections. The valves have a minimum close off pressure of not

less than 75 psi and is rated for a maximum working pressure of 250 psi. The actuators are rated for 24 Vac.

300 PSI Water Box on Condenser/Evaporator

Note: This section applies only to TACW model.

TACW Condenser and Evaporator barrels are available with 300PSI waterbox. This option does not affect overall dimensions of chiller.

Tank and Pump Module

Note: This section applies only to AMC, MAR, MWC, and WXM models.

A tank and pump module contains:

- Dual lead/lag 100% redundant stainless steel fitted centrifugal pumps each sized to provide the design flow rate at the design pressure head.
- Discharge check valves and suction and discharge isolation valves.
- Discharge pressure gauge.
- Microprocessor controller with automatic lead/lag switching of pumps on time and failure.
- Roll grooved pipe connections.
- Diaphragm expansion tank.
- Glycol make up tank with charging pump (for glycol fluid hydronic systems).

Optional:

- Variable frequency drive and TEFC premium efficient pump motor for varying each pump speed and flow rate for variable primary flow systems.
- Suction diffuser/strainer on each pump inlet.
- Sealed stainless steel reservoir (in lieu of a diaphragm expansion tank) includes a liquid level sight glass with isolation valves, glycol feeder with charging pump (for hydronic systems with glycol), a low-level cut-out to prevent pump operation in low level conditions, relief valve and vacuum vent and enclosed with 3/4-inch closed cell insulation.

Pump Module

Note: This section applies only to AMC, AXM, MAR, MWC, and WXM models.

A pump module contains:

- Dual lead/lag 100% redundant stainless steel fitted centrifugal pumps each sized to provide the design flow rate at the design pressure head.
- Discharge check valves and suction and discharge isolation valves.
- Discharge pressure gauge.
- Microprocessor controller with automatic lead/lag switching of pumps on time and failure.
- Roll grooved pipe connections.

Optional:

- Variable frequency drive and TEFC premium efficient pump motor for varying each pump speed and flow rate for variable primary flow systems.
- Suction diffuser/strainer on each pump inlet.

High Ambient Operation

Oversized Condenser

Note: This section applies only to AMC and MAR models.

25-, 30-, 50-, 60-ton AMC chillers can be equipped with an oversized condenser for operating in ambient temperatures exceeding 110°F. Oversize condensers are available for all MAR models.

Low Ambient Operation

Integral Free Cooling

Note: This section applies only to AMC model.

Aluminum fins mechanically bonded to fluid filled copper tubes can be installed integral to the chiller module for partial and full free cooling. Fin spacing does not exceed 16 fpi. The coils are designed to provide partial free cooling starting at an ambient temperature 5° below the chilled fluid temperature entering the chiller system. The tubes and headers are sized for a maximum velocity of no more than 7 ft/sec. Brass Turbospirals are installed within the coil tubes to increase the amount of turbulence in the fluid flow thereby increasing the rate of heat transfer.

Included is a 3-way, 2-position valve to divert the system fluid to the free cooling coils when the ambient temperature falls 5° F below the chilled fluid temperature entering the chiller system to begin partial free cooling. This temperature set point is clearly displayed via a digital LCD display and is field adjustable. The valve actuator is housed in a NEMA 3R weather resistant enclosure. The module piping includes isolation valves on all three ports to allow the 3-way valve to be removed from the piping for service and replaced without shutting down the system.

Flooded Condenser

Note: This section applies only to AMC and MAR models.

Flooded condenser head pressure control is used to allow operation in ambient temperatures down to -20° F (typical). This option uses a larger charge of refrigerant with a refrigerant receiver to fill the condenser coil with up to 80% of liquid refrigerant such that it effectively reduces the condenser capacity. Flooded condenser head pressure control uses a head pressure control valve on each circuit to store excess refrigerant in the liquid refrigerant receiver during warmer ambient temperatures when the condenser coil is not flooded. These features provide a means for the chiller module to maintain minimum suction and head pressures during low ambient operation.

Refrigerant Liquid Receivers

Note: This section applies only to AMC and MAR models.

A refrigerant receiver is included on each refrigeration circuit for flooded condenser head pressure control. Each are sized to accommodate the required system pump down capacity. The receivers are provided with service valves for service isolation. A pressure relief valve is installed on the refrigerant receiver and piped to the outside of the chiller cabinet. Heat tracing can be provided on the receivers for chillers located in northern environments to keep the refrigerant temperature warm during off cycles to prevent low pressure trips when a compressor starts.

Heat Tracing

Note: This section applies only to AMC, AXM, and MAS models.

This option allows for either the evaporator only or all wetted components to be protected against freezing by installing self-regulating heat trace cable. The heat trace cable is UL listed and CSA certified and consists of two 16 AWG nickel-copper bus wires embedded in parallel in a self-regulating polymer core that varies its power output to respond to temperature along its length. The heat trace cable has a heat output of 6 watts per ft. The cable must be powered by a 120/60/1 circuit provided by others.

Low Lift Refrigerant Pump

Note: This section applies only to TACW model.

Refrigerant pump ensures proper compressor motor cooling during low lift operations producing higher chilled water temperatures, lower condensing temperatures, and better continuous unloading.

Electrical Options

Single Point Power with Power Distribution Panel

Note: This section applies to all Thermafit models except the TACW. The Power Distribution Panel comes standard on the TACW model.

A single electrical power supply feeds a power distribution panel. The panel is mounted on the primary module (or lead-free cooling module or tank and pump module, if equipped) and contains a circuit breaker for each module for branch circuit overload protection for both high and standard fault systems.

Fused or Non-Fused Disconnect Switch

Note: This section applies to all Thermafit models.

Systems are optionally equipped with a panel-mounted fused or non-fused disconnect switch installed on the power distribution depending on the SCCR protection required. A fused disconnect switch with an appropriate power distribution block on the power distribution panel provides high fault SCCR protection. For standard fault SCCR protection, the fused disconnect is replaced with a non-fused disconnect switch. These disconnect options are only offered on the power distribution panel.

Individual Power

Note: This section applies to all Thermafit models.

If a single point power supply is not required, individual power to each module is provided. Power is landed on a distribution block or disconnect switch on each module's high voltage electrical panel depending on the fault rating option selected. For TACW, Power is landed on compressor Disconnect switch.

65kA SCCR Protection

Note: This section applies to all Thermafit models except the TACW. 65kA SCCR Protection comes standard on the TACW model.

Module panels are optionally equipped with a power distribution block or a 65kA circuit breaker depending on the SCCR protection or disconnect option required for both single point power and individual power options. Module high voltage panels always have 65kA compressor circuit breakers. 65kA SCCR protection for either single point power or individual power includes an optional combination of fused disconnect and power distribution block on the power distribution panel, 65kA module main circuit breaker, and 65kA compressor circuit breakers.

NEMA 4X Electrical and Power Distribution Panels

Note: This section applies to all Thermafit models except the TACW.

NEMA 4X stainless steel electrical panels provide protection for electrical equipment in harsh, corrosive, indoor or outdoor environments. The panel ensures protection against corrosion, dust, water, windblown rain, and ice.

NEMA 4X Electrical VFD Panels

Note: This section applies only to AMC, MAR, MWC, and WXM models.

NEMA 4X stainless steel electrical panels provide protection for VFDs in harsh, corrosive, indoor or outdoor environments. The panel ensures protection against corrosion, dust, water, windblown rain, and ice.

Passive Harmonic Filters

Note: This section applies only to TACW model.

Passive harmonic filters are used to eliminate harmonic distortion caused by excess currents in and out of appliances.



Control Options

BMS Integration

Note: This section applies to all Thermafit models except the TACW. BMS Integration comes standard on the TACW model.

The primary controller provides communications to the building management system. The system interfaces with the BMS via BACnet® MS/TP or BACnet IP/ Ethernet, Modbus™ or LONWORKS®. All functions of the control system are accessible from the BMS including: Chiller enable/disable; Compressor run status; Pump controls; System evaporator and condenser temperatures; Adjustment of all system set points; Review and resetting of all non-active faults; Interrogation and display of all sensor faults.

Remote Monitoring

Note: This section applies to all Thermafit models.

This option allows a user to perform remote management and monitor and adjust on-site operation data such as pressures, temperatures, time delays, alarm and fault information, trending, troubleshooting, preventive maintenance, and data analysis.

Sound Options

Compressor Wraps

Note: This section applies to all Thermafit models.

Compressor sound wraps are acoustical absorbing blankets made of quilted fibrous glass that reduce compressor noise for a quieter chiller operation.

Acoustical Panels

Note: This section applies only to MWC, MWS, and WXM models.

1-inch multi-layered polyether urethane open cell foam installed inside the units formed sheet metal panels and frame to reduce reverberation and to lower reflected sound.

Other Options

Copper Finned Condenser Coil

Note: This section applies only to AMC and MAR models.

For corrosive or harsh coastal environments, condenser coils can be offered with all copper fin construction instead of aluminum. Copper has better corrosion resistance than aluminum. The copper tubes are mechanically expanded into the fin collars providing a permanent metal-to-metal bond for efficient heat transfer.

Epoxy Coated Condenser/Air Coils

Note: This section applies only to AMC, AXM, MAR, and MAS models.

Coating the air coil with a flexible epoxy polymer for corrosion resistance is ideal for locations with high humidity and an aggressive atmosphere.

Epoxy Coated Evaporator/Condenser

Note: This section applies only to TACW model.

Coating offers excellent erosion resistance.

Stainless Steel Cabinet Enclosure

Note: This section applies only to AMC, AXM, and MAS models.

Stainless steel sheet metal panels are available for corrosion resistance and are easily removable for servicing via stainless steel fasteners and retaining clips.

Header System

Note: This section applies only to TACW model.

Header system includes 4 headers and steel frame. Available in 8-inch and 10-inch sizes, depending on flow requirements.

Full/Partial Knockdown

Note: This section applies only to TACW model.

Full knockdown involves the chiller being assembled for testing but will have the compressor(s), condensers, evaporators, and panels removed, packaged, and shipped separately with the chiller. In this case, the refrigerant will be removed from the vessels and sent to the site separately. Heat exchangers will be shipped separately with a small charge of dry nitrogen. The discharge pipe assembly shall be provided with rigging flanges for quick re-installation. Compressor(s), control panel, and power and control cables will be labelled and shipped ready for field connection. Contractor will be required to leak check, evacuate, charge unit prior to requesting start-up.

Partial knockdown involves the chiller being shipped with the compressor removed. The compressor will be shipped in a separate box, and the chiller shipped with a holding charge of nitrogen and a separate holding charge of refrigerant.

Evaporator/Condenser Water Box Hinges

Note: This section applies only to TACW model.

Water Box hinges provide safe and reliable means for waterside service. This easy access is beneficial when conducting routine chiller maintenance.

ASME UM Stamp

Note: This section applies to all Thermafit models except the TACW.

ASME Boiler and Pressure Vessel Code is stamped on the heat exchanger(s) to certify that the equipment conforms to the rules governing the design, fabrication, assembly, and inspection of boiler and pressure vessel components during construction.

Isolation Pads

Note: This section applies only to TACW model.

Isolation pads are offered in a set of four, made of waffled rubber, and prevent vibration, shock, and noise.

1.5-inch Insulation

Note: This section applies only to TACW model.

Trane - by Trane Technologies (NYSE: TT), a global innovator - creates comfortable, energy efficient indoor environments for commercial and residential applications. For more information, please visit trane.com or tranetechnologies.com.

Trane has a policy of continuous product and product data improvements and reserves the right to change design and specifications without notice. We are committed to using environmentally conscious print practices.