



Product Catalog

Ascend™ Air-Cooled Chiller Models ACS and ACX

With Symbio™ Controls
80 to 230 Nominal Tons





Introduction

Design and manufacturing excellence makes Trane a leader in the air-cooled chiller marketplace. This tradition of using excellence to meet market demands is illustrated with the Trane Ascend™ line of air-cooled chiller. This chiller is an exciting step forward in energy efficiency, sound, reliability, ease of serviceability, control precision, application versatility, and operational cost-effectiveness. The chiller is designed to deliver proven Trane performance and reliability.

Copyright

This document and the information in it are the property of Trane, and may not be used or reproduced in whole or in part without written permission. Trane reserves the right to revise this publication at any time, and to make changes to its content without obligation to notify any person of such revision or change.

Trademarks

All trademarks referenced in this document are the trademarks of their respective owners.

Revision History

- Updated the Unit Dimensions drawings in the Dimensions and Weights section.
- Added ACX sizes 80 to 120 tons.
- Added Partial Heat Recovery content in the document.
- Updated the Life Cycle Cost-Effectiveness and Application Versatility sections in the Features and Benefits chapter.
- Updated the Water Treatment, Ambient Limitations, and Water Temperature sections in the Application Considerations chapter.
- Updated the Unit Model Number section in the Model Number Descriptions chapter.
- Updated the general data tables.
- Removed the Rapid Restart Test section from the Controls chapter.
- Updated electrical data tables.
- Updated the Unit Dimensions, Service Clearance, and Weights sections in the Dimensions and Weights chapter.
- Updated the Refrigeration Circuits and Compressor sections in the Mechanical Specifications chapter.
- Updated the Pump Package section in the Options chapter.
- Added the Water Reversing Valve Assembly(Option) section in the Options chapter.



Table of Contents

Features and Benefits	5
Reliability	5
Life Cycle Cost-Effectiveness	5
Application Versatility	5
Simple, Economical Installation	5
Precision Control	6
Improved Serviceability	6
Application Considerations	7
Unit Sizing	7
Water Treatment	7
Effect of Altitude on Capacity	7
Ambient Limitations	7
Water Flow Limits	8
Water Temperature	9
Supply Water Temperature Drop	9
Typical Water Piping	10
Multiple Unit Operation	10
Thermal Battery Cooling System Operation	10
Heat Pump	11
Partial Heat Recovery	11
Unit Placement	11
Unit Location	12
Model Number Descriptions	14
Unit Model Number	14
General Data	16
Controls	21
Symbio™ 800 Controller	21
AdaptiView™ TD7 Display	21
System Integration	22
Building Automation and Chiller Plant Control	25
Integrated Comfort System (ICS)	25
Electrical Data	26



Table of Contents

Dimensions and Weights	31
Unit Dimensions	31
Service Clearance	35
Weights	36
Mechanical Specifications	37
General	37
Certified AHRI Performance	37
Refrigeration Circuits	37
Evaporator	37
Condenser and Fans	37
Compressor	38
Unit Controls	38
Chilled Water Reset	39
Factory Mounted Flow Proving and Flow Control	39
Options	40
Application Options	40
Electrical Options	41
Control Options	41
Sound Options	42
Other Options	42



Features and Benefits

Reliability

- Years of laboratory testing, including running the chiller at extreme operating conditions, have resulted in optimized compressor and chiller systems reliability by confirming a robust design and verifying quality each step of the way.
- Direct-drive, low-speed scroll compressors with intermediate discharge valve to increase seasonal efficiency. Suction gas-cooled motor stays at a uniformly low temperature for long motor life.
- Powered by Symbio™ 800 industry-leading control algorithms—enhanced flow management provides unmatched system performance in variable flow water systems.
- Standard factory-installed water strainer helps prevent system debris from affecting unit flow or heat transfer.
- Flow switch is factory-installed at the optimum location in the piping for reduced chiller installation cost and superior flow sensing, reducing the potential for nuisance trips.
- On cooling-only ACS units, the microchannel condenser uses all-aluminum coils with fully-brazed construction. This design reduces risk of leaks. Their flat streamlined tubes with small ports and metallurgical tube-to-fin bond enable exceptional heat transfer and dramatic reduction in refrigerant use.
- Variable speed permanent magnet motors on **all** condenser fans for increased efficiency and lower sound.

Life Cycle Cost-Effectiveness

- Optimized for part load performance.
- Scroll compressors with intermediate discharge valve to increase seasonal efficiency. Scroll compressors with vapor injection to enlarge the operating envelope by reduction of resulting discharge temperature; To improve cooling capacity and efficiency by reduction of the liquid temperature before expansion (Intermediate heat exchanger acting as economizer); To improve heating capacity and efficiency by increase of the massflow at the condenser side (condenser massflow will be the sum of the evaporator massflow and the injected massflow).
- Waterside reversing valve option to improve heating efficiency.
- Optional pump package features variable speed drive on the pump motors, eliminating the need for energy sapping chilled water system triple-duty or balancing valves. Additionally, system commissioning and flexibility is greatly enhanced. Chilled water supply reliability is increased with the dual pump design, due to standard failure/recovery functionality.
- Partial heat recovery provides energy savings for preheating or reheating applications.

Application Versatility

- **Low temperature process cooling:** Excellent operating temperature range and precise control capabilities enable tight control.
- **Thermal energy storage:** Utilities and owners benefit from reduced cooling energy cost. The AquaStream chiller's dual setpoint control and industry leading energy storage efficiency assures reliable operation and superior system efficiency. Trane's partnership with CALMAC® brings a proven track record of successful installations across many markets; from churches and schools to sky scrapers and office buildings.
- **Partial heat recovery:** Optional factory-installed heat exchanger provides hot water for various applications, such as water preheating and reheating for enhanced system humidity control. Partial heat recovery reduces operating costs associated with boilers/domestic hot water.

Simple, Economical Installation

- Compressor sound attenuation, variable speed fans, and night noise setback help reduce sound levels, making it the perfect solution for chiller installation in a neighborhood.



Features and Benefits

- System integration available with LonTalk®, ModBus™, or BACnet ®through a single twisted-pair wire for a less expensive translation to an existing building automation system.
- Powder-coated paint provides superior durability, corrosion protection, and is less likely to be damaged while rigging/lifting/installing the chiller.
- Factory commissioned unit-mounted starter reduces overall job cost and improves system reliability by eliminating job site design, installation and labor coordination requirements.

Precision Control

- 7–inch color touch screen display with graphics.
- Powered by Symbio™ 800 industry-leading control algorithms — Enhanced flow management provides unmatched system performance in variable flow water systems.
- Adaptive Control™ keeps the chiller running in extreme conditions.
 - Tight set point control.
 - Graphical trending.
 - Maximized chiller update.
- BACnet®, Modbus®, LonTalk®, communications protocol interface available without the need for gateways.
- Optional condenser fan speed control to help meet preset nighttime sound requirements.

Improved Serviceability

- All major serviceable components are close to the edge. Service shutoff valves and water strainer are conveniently located to enable easy service.
- Full on-site serviceability
- Electronic expansion valve designed so controls can be removed and serviced without refrigerant handling.



Application Considerations

Certain application constraints should be considered when sizing, selecting, and installing Trane chillers. Unit and system reliability is often dependent on properly and completely complying with these considerations. When the application varies from the guidelines presented, it should be reviewed with your local sales engineer.

Note: *The terms water and solution are used interchangeably in the following paragraphs.*

Unit Sizing

See TSA™ performance selection software for unit capacities. Intentionally oversizing a unit to ensure adequate capacity is not recommended. Erratic system operation and excessive compressor cycling are often a direct result of an oversized chiller. In addition, an oversized unit is usually more expensive to purchase, install, and operate. If oversizing is desired, consider using two units.

Water Treatment

The use of untreated or improperly treated water may result in scaling, erosion, corrosion, and algae or slime buildup. This will adversely affect heat transfer between the water and system components. Proper water treatment must be determined locally and depends on the type of system and local water characteristics. The chloride content of the coolant should be no higher than 200PPM to avoid corrosion.

Neither salt nor brackish water is recommended for use in Trane chillers. Use of either will lead to a shortened life. Trane encourages the employment of a qualified water treatment specialist, familiar with local water conditions, to assist in the establishment of a proper water treatment program.

Foreign matter in the chilled water system can also increase pressure drop and, consequently, reduce water flow. For this reason it is important to thoroughly flush all water piping to the unit before making the final piping connections to the unit.

Effect of Altitude on Capacity

At elevations substantially above sea level, decreased air density will reduce condenser capacity and, therefore, unit capacity and efficiency.

Ambient Limitations

Trane chillers are designed for year-round operation over a range of ambient temperatures.

- **Standard Ambient Range:** 32 to 105°F (0 to 40.5°C)
- **Low Ambient Range:** -20 to 105°F (-29 to 40.5°C)
- **High Ambient Range:** 32 to 125°F (0 to 51.7°C)
- **Wide Ambient Range:** -20 to 125°F (-29 to 51.7°C)
- **Cooling Mode Ambient Range for Heat Pump:** -4 to 125°F (-20 to 51.7°C)
- **Heating Mode Ambient Range for Heat Pump:** -15 to 95°F (-26 to 35°C)

Operation below 32°F requires the use of variable speed fans unless otherwise specified.

Operation below 0°F of heating mode requires the use of a glycol solution, even the water flow is not lower than minimum flow of the AHRI cooling condition.

Operation below 32°F of heating mode requires the use of a glycol solution, as water flow is lower than minimum flow of the AHRI cooling condition.

The minimum ambient temperatures are based on still conditions (winds not exceeding five mph).

Greater wind speeds will result in a drop in head pressure, therefore increasing the minimum starting and operating ambient temperature. The Adaptive Control™ microprocessor will attempt to keep the chiller on-line when high or low ambient conditions exist, making every effort to avoid nuisance trip-outs and provide the maximum allowable tonnage.

Water Flow Limits

The minimum water flow rates are given in the General Data chapter of this catalog. Evaporator flow rates below the tabulated values will result in laminar flow causing freeze-up problems, scaling, stratification and poor control.

The maximum evaporator water flow rate is also given in General Data. Flow rates exceeding those listed may result in very high pressure drop across the evaporator and/or excessive tube erosion.

Note: Flow rates in the general data tables are for water only. They do not include freeze inhibitors.

Flow Rate Out of Range

Many process cooling applications require flow rates that cannot be met with the minimum and maximum published values within the evaporator. A simple piping change can alleviate this problem. For example: a plastic injection molding process requires 80 gpm (5.0 l/s) of 50°F (10°C) water and returns that water at 60°F (15.6°C). The selected chiller can operate at these temperatures, but has a minimum flow rate of 106 gpm (6.6 l/s). The system layout in the figure below can satisfy the process.

Figure 1. Flow rate out of range systems solution

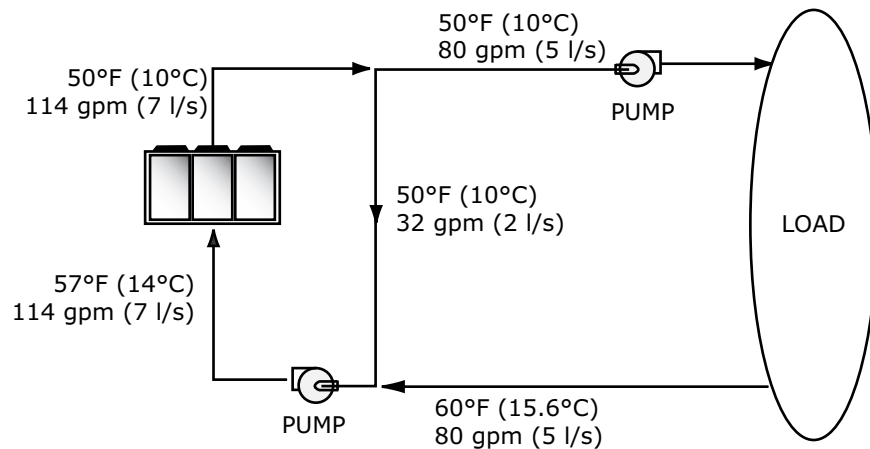

Flow Proving

Trane provides a factory-installed water flow switch monitored by Symbio™ 800 controller which protects the chiller from operating in loss of flow conditions.

Variable Flow in the Evaporator

Variable Primary Flow (VPF) systems present building owners with several cost-saving benefits when compared with Primary/Secondary chilled water systems. The most obvious cost savings results from eliminating the constant volume chiller pump(s), which in turn eliminates the related expenses of the associated piping connections (material, labor), and electrical service and switch gear. In addition to the installed cost advantage, building owners often cite pump related energy savings as the reasons that prompted them to select a VPF system.

The chiller is capable of handling variable evaporator flow without losing control of the leaving water temperature. The microprocessor and capacity control algorithms will respond to a 10 percent change in water flow rate per minute while maintaining a $\pm 2^\circ\text{F}$ (1.1°C) leaving water temperature control accuracy. The chiller tolerates up to 30 percent per minute water flow variation as long as the flow is equal or above the minimum flow rate requirement.

With the help of a software analysis tool such as System Analyzer™, DOE-2 or TRACE™, anticipated energy savings can be determined, and used to justify variable primary flow in a particular application. Existing constant flow chilled water systems may be relatively easily converted to VPF and benefit greatly from the inherent efficiency advantages.

Water Temperature

Leaving Water Temperature Limits

Trane chillers have distinct leaving water categories:

- Standard, with a leaving solution range of 40 to 68°F (4.4 to 20°C)
- Low temperature process cooling, with leaving solution less than 40°F (4.4°C)
- Ice-making, with leaving solution less than 40°F

Since leaving solution temperatures below 40°F (4.4°C) result in suction temperature at or below the freezing point of water, a glycol solution is required for all low temperature and ice-making machines. Ice making control includes dual setpoints and safeties for ice making and standard cooling capabilities. Consult your local Trane account manager for applications or selections involving low temperature or ice making machines.

The maximum water temperature that can be circulated through the evaporator when the unit is not operating is 125°F (52°C). Evaporator damage may result above this temperature.

Leaving Water Temperature Out of Range

Many process cooling jobs require temperature ranges that cannot be met with the minimum and maximum published values for the chiller. A simple piping change can alleviate this problem. For example, a laboratory load requires 238 gpm (15 l/s) of water entering the process at 86°F (30°C) and returning at 95°F (35°C). The chiller's maximum leaving chilled water temperature of 68°F (20°C) prevents direct supply to the load. In the example shown, both the chiller and process flow rates are equal, however, this is not necessary. For example, if the chiller had a higher flow rate, there would be more water bypassing and mixing with warm water returning to the chiller.

Figure 2. Temperature out of range system solution

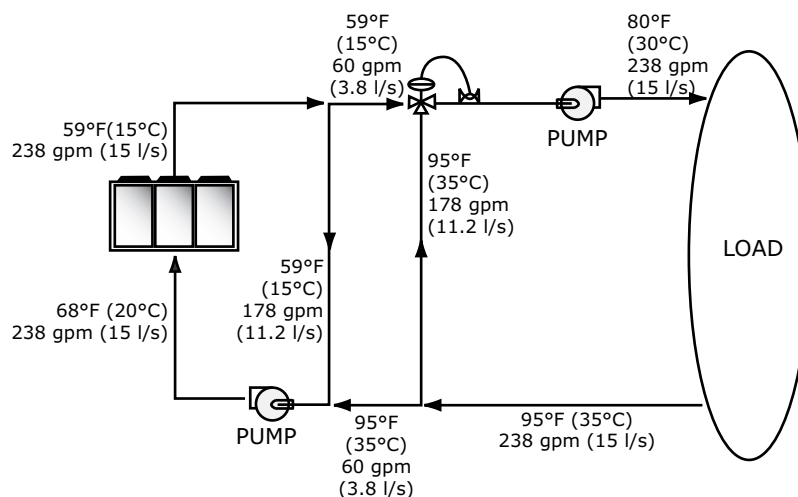

Supply Water Temperature Drop

The cataloged performance data for the chiller is based on a chilled water temperature drop of 10°F (6°C) for I-P data and 9°F (5°C) for SI data. Full load chilled water temperature drops from 6 to 18°F (3.3 to 10°C) may be used as long as minimum and maximum water temperature and minimum and maximum flow rates are not exceeded. Temperature drops outside this range at full load conditions are beyond the optimum range for control and may adversely affect the microcomputer's ability to maintain an acceptable supply water temperature range. Furthermore, full load temperature drops of less than 6°F (3.3°C) may result in inadequate refrigerant superheat which is critical to long term efficient and reliable operation. Sufficient superheat is always a primary concern in any refrigerant system and is especially important in a packaged chiller where the evaporator is closely coupled to the compressor.



Typical Water Piping

All building water piping must be flushed prior to making final connections to the chiller. To reduce heat loss and prevent condensation, insulation should be applied. Expansion tanks are also usually required so that chilled water volume changes can be accommodated.

Avoidance of Short Water Loops

Adequate chilled water system water volume is an important system design parameter because it provides for stable chilled water temperature control and limits compressor short cycling.

The chiller temperature control sensor is located in the supply (outlet) water connection or pipe. This location allows the building to act as a buffer to slow the rate of change of the system water temperature. If there is not a sufficient volume of water in the system to provide an adequate buffer, temperature control can suffer, resulting in erratic system operation and excessive compressor cycling.

Typically, a two-minute water loop circulation time is sufficient to prevent short water loop issues. Therefore, as a guideline, ensure the volume of water in the chilled water loop equals or exceeds two times the evaporator flow rate. For systems with a rapidly changing load profile the amount of volume should be increased.

If the installed system volume does not meet the above recommendations, the following items should be given careful consideration to increase the volume of water in the system and, therefore, reduce the rate of change of the return water temperature.

- A volume buffer tank located in the return water piping.
- Larger system supply and return header piping (which also reduces system pressure drop and pump energy use).

Minimum Water Volume for a Process Application

If a chiller is attached to an on/off load such as a process application, it may be difficult for the controller to respond quickly enough to the very rapid change in return solution temperature if the system has only the minimum recommended water volume. Such systems may cause chiller low temperature diagnostics or in the extreme case evaporator freezing. In this case, it may be necessary to add or increase the size of the mixing tank in the return line.

Multiple Unit Operation

Whenever two or more units are used on one chilled water loop, Trane recommends that their operation be coordinated with a higher level system controller for optimum system efficiency and reliability. The Trane Tracer® system has advanced chilled plant control capabilities designed to provide such operation.

Thermal Battery Cooling System Operation

A Thermal Battery™ cooling system uses the chiller to make (cooling) ice at night when utilities generate electricity more efficiently with lower demand and energy charges. The stored cooling energy reduces or even replaces mechanical cooling during the day when utility rates are at their highest. This reduced electrical demand for cooling results in significant utility cost savings and source energy savings.

Another advantage of an ice energy storage system is its ability to eliminate chiller over sizing. A “right-sized” chiller plant with ice energy storage operates more efficiently with smaller support equipment while lowering the connected load and reducing operating costs. Best of all, this system still provides a capacity safety factor and redundancy by designing reserve capacity into the ice storage system for practically no cost compared to oversized systems.

Trane air-cooled chillers are uniquely suited to low temperature applications like ice storage because of the ambient relief experienced at night. Chiller ice making efficiencies are typically similar to or even better than standard cooling daytime efficiencies as a result of night-time dry-bulb ambient relief.

Standard smart control strategies for ice storage systems are another advantage of the chiller. The dual mode control functionality is integrated right into the chiller. Trane Tracer® building management systems can measure demand and receive pricing signals from the utility and decide when to use the stored cooling and when to use the chiller.

Heat Pump

When the HVAC system demand switches between heating and cooling the heat pump mode is switched and the reversing valve in each functioning circuit reverses the refrigerant cycle to produce the required heating or cooling supply. The air-to-water heat pump unit does not simultaneously heat and cool. It only produces either heating or cooling at any moment in time depending on the commanded mode of operation. The ambient air surrounding the unit provides for the heat source/sink and units are typically located outdoors. When operating in heating mode in low temperature moist climates frost may form on the outdoor coils. The units will periodically defrost the outdoor coils by reversing the refrigerant cycle for a period of time. Modules are sequentially defrosted to minimize the impact to heating capacity. The defrost cycle must be taken into account when sizing the hydronic system volume to verify heating supply capacity.

Partial Heat Recovery

Partial heat recovery is designed to capture a portion of the heat that is normally rejected to the atmosphere and put it to beneficial use. With the addition of a heat recovery cycle, heat removed from the building cooling load can be transferred to a preheat application. The heat recovery cycle is only possible if a cooling load exists to act as a heat source. In other words, the partial heat recovery heat exchanger cannot operate alone without a load on the chiller.

To provide a heat recovery cycle, a supplemental heat exchanger is mounted in series to the air-cooled condenser. During the heat recovery cycle, the unit operates just as it does in the cooling-only mode, except a portion of the cooling load heat is rejected to the water heating circuit rather than to the air through the air-cooled condenser. In order to recover more heat, fan speed can be selected as heat recovery priority, slowing fans below the cooling priority speed. A factory-installed refrigerant side two-way valve protects the unit from running trip and adjusts the leaving hot water temperature. Water circulated through the heat recovery heat exchanger absorbs heat from the compressed refrigerant gas discharged by the compressors.

Partial heat recovery can be used in applications where hot water is needed, i.e. kitchens, lavatories, etc. The partial heat recovery heat exchanger provides up to 140°F (60°C) leaving hot water temperature. For more information see Trane Select Assist™ (TSA) performance selection program.

Unit Placement

Setting the Unit

A base or foundation is not required if the selected unit location is level and strong enough to support the unit operating weights shown in Weights chapter.

For a detailed discussion of base and foundation construction, see the unit Installation, Operation or Maintenance (IOM) manual. Manuals are available through trane.com or from your local office.

HVAC equipment must be located to minimize sound and vibration transmission to the occupied spaces of the building structure it serves. If the equipment must be located in close proximity to a building, it should be placed next to an unoccupied space such as a storage room, mechanical room, etc. It is not recommended to locate the equipment near occupied, sound sensitive areas of the building or near windows. Locating the equipment away from structures will also prevent sound reflection, which can increase sound levels at property lines or other sensitive points.

Isolation and Sound Emission

Structurally transmitted sound can be reduced by elastomeric vibration eliminators. Elastomeric isolators are generally effective in reducing vibratory noise generated by compressors, and therefore, are recommended for sound sensitive installations. An acoustical engineer should always be consulted on critical applications.

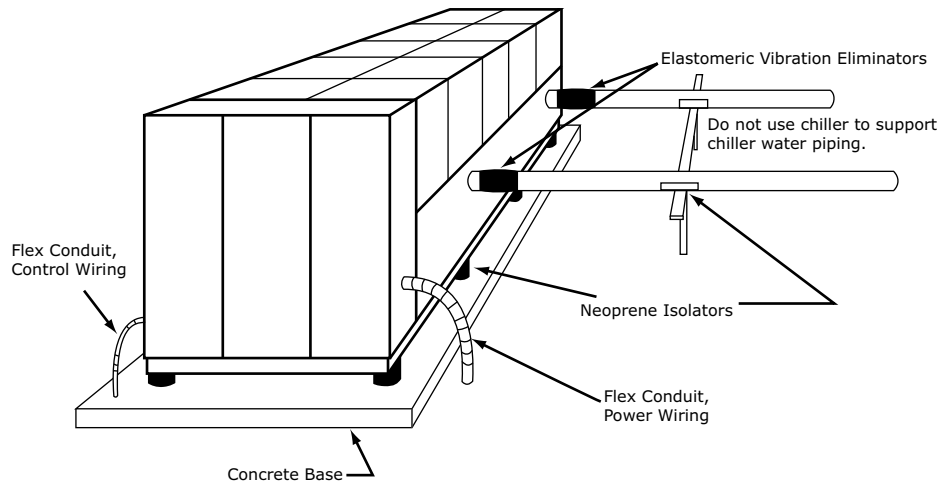
Figure 3. Installation example

For maximum isolation effect, water lines and electrical conduit should also be isolated. Wall sleeves and rubber isolated piping hangers can be used to reduce sound transmitted through water piping. To reduce the sound transmitted through electrical conduit, use flexible electrical conduit.

Local codes on sound emissions should always be considered. Since the environment in which a sound source is located affects sound pressure, unit placement must be carefully evaluated. Sound power levels for chillers are available on request.

Servicing

Adequate clearance for evaporator, condenser and compressor servicing should be provided. Recommended minimum space envelopes for servicing are located in the dimensional data section and can serve as a guideline for providing adequate clearance. The minimum space envelopes also allow for control panel door swing and routine maintenance requirements. Local code requirements may take precedence.

Unit Location

General

Unobstructed flow of condenser air is essential to maintain chiller capacity and operating efficiency. When determining unit placement, careful consideration must be given to assure a sufficient flow of air across the condenser heat transfer surface. Two detrimental conditions are possible and must be avoided: warm air recirculation and coil starvation. Air recirculation occurs when discharge air from the condenser fans is recycled back to the condenser coil inlet. Coil starvation occurs when free airflow to the condenser is restricted.

Condenser coils and fan discharge must be kept free of snow or other obstructions to permit adequate airflow for satisfactory unit operation. Debris, trash, supplies, etc., should not be allowed to accumulate in the vicinity of the air-cooled chiller. Supply air movement may draw debris into the condenser coil, blocking spaces between coil fins and causing coil starvation.

Both warm air recirculation and coil starvation cause reductions in unit efficiency and capacity due to higher head pressures. The air-cooled chiller offers an advantage over competitive equipment in these situations. Operation is minimally affected in many restricted air flow situations due to its advanced Adaptive Control™ microprocessor which has the ability to understand the operating environment of the chiller and adapt to it by first optimizing its performance and then staying on line through abnormal conditions. For example, high ambient temperatures combined with a restricted air flow situation will generally not cause the air-cooled chiller to shutdown. Other chillers would typically shutdown on a high pressure nuisance cut-out in these conditions.

Cross winds, those perpendicular to the condenser, tend to aid efficient operation in warmer ambient conditions. However, they tend to be detrimental to operation in lower ambients due to the accompanying loss of adequate head pressure. Special consideration should be given to low ambient

units. As a result, it is advisable to protect air-cooled chillers from continuous direct winds exceeding 10 mph (4.5 m/s) in low ambient conditions.

The recommended lateral clearances are depicted in the close spacing engineering bulletin available from your local office.

Provide Sufficient Unit-to-Unit Clearance

Units should be separated from each other by sufficient distance to prevent warm air recirculation or coil starvation. Doubling the recommended single unit air-cooled chiller clearances will generally prove to be adequate.

Walled Enclosure Installations

When the unit is placed in an enclosure or small depression, the top of the surrounding walls should be no higher than the top of the fans. The chiller should be completely open above the fan deck. There should be no roof or structure covering the top of the chiller. Ducting individual fans is not recommended.



Model Number Descriptions

Unit Model Number

Digit 1, 2, 3, 4 — Unit Model

ACSA = Air-Cooled Scroll Chiller
ACXA = Air-Cooled Scroll Heat Pump Chiller

Digit 5, 6, 7 — Nominal Tonnage

080 = 80 Tons
100 = 100 Tons
120 = 120 Tons
140 = 140 Tons
160 = 160 Tons
180 = 180 Tons
200 = 200 Tons
215 = 215 Tons
230 = 230 Tons

Digit 8 — Compressor Type

2 = Scroll with Variable Volume Ratio
8 = Scroll with variable volume ratio and vapor injection

Digit 9 — Unit Voltage

A = 200V/60Hz/3 phase
B = 230V/60Hz/3 phase
C = 380V/60Hz/3 phase
D = 400V/60Hz/3 phase
E = 460V/60Hz/3 phase
F = 575V/60Hz/3 phase

Digit 10 — Manufacturing Location

U = Trane Commercial Systems, Pueblo, CO USA

Digits 11, 12 — Design Sequence

** = Factory assigned

Digit 13 — Unit Sound Package

X = Standard Unit
L = Superior
R = Standard with Noise Reduction Request
Q = Superior with Noise Reduction Request

Digit 14 — Agency Listing

E = ETL Listed/Certified to CSA/Conforms to UL
C = No Agency Listing

Digit 15 — Pressure Vessel Code

X = Not Applicable
C = CRN or Canada Equivalent
U = ASME pressure vessel code

Digit 16 — Factory Charge

L = Refrigerant Charge R-454B
M = Nitrogen Charge (R-454B Field Supplied)

Digit 17 — Auxiliary Items

X = No Auxiliary Items
D = Condenser Drain Pan - HP Units Only
G = Heating Water Side Reversing Valve and Drain Pans
H = Heating Water Side Reversing Valve without Drain Pans

Digit 18 — Evaporator Application

N = Standard Cooling
P = Low Temp Process Cooling
F = Lower Temp Process Cooling
C = Ice Making

Digit 19, 20 — Evaporator Type

B2 = Brazed Plate Heat Exchanger (Standard)

Digit 21 — Water Connection

X = Grooved Pipe
A = Grooved Pipe + Flange Adapter

Digit 22 — Flow Switch Set Point

C = Flow Switch Setpoint 15
F = Flow Switch Setpoint 35
H = Flow Switch Setpoint 45
L = Flow Switch Setpoint 60

Digit 23 — Insulation

N = Standard 0.75 inch
H = Evaporator-Only 1.25 inch humidity/low evap

Digit 24 — Unit Application

X = Standard Ambient
L = Low Ambient
H = High Ambient
W = Wide Ambient

Digit 25 — Condenser Length

S = Standard

Digit 26 — Condenser Fin Options

M = Aluminum Microchannel
C = CompleteCoat™ Microchannel
R = Copper Round Tube, Aluminum Plate Fin
K = Coated Copper Round Tube, Aluminum Plate Fin

Digit 27 — Fan Type

E = EC Condenser Fan Motors
F = Fixed Speed Fans

Digit 28 — Compressor Starter

X = Across-the-Line Starter

Digit 29 — Incoming Unit Power Line Connection

1 = Single Point Unit Power Connection

Digit 30 — Power Line Connection Type

T = Terminal Block
C = Circuit Breaker
M = High Fault Rated Circuit Breaker with Energy Meter
H = High Fault Rated Circuit Breaker

Digit 31 — Short Circuit Current Rating

A = Default Short Circuit Rating
B = High Short Circuit Rating

Digit 32 — Electrical Accessories

X = None
U = Under/Over Voltage Protection
N = 20A - 115V Convenience Outlet
B = Convenience Outlet and Under/Over Voltage Protection

Digit 33 — Remote Communications Options

X = None
B = BACnet® Interface (MS/TP)
p = BACnet Interface (IP)
M = Modbus™ Interface
L = LonTalk® Interface

Digit 34 — Hard Wire Communication

X = None
A = Hard Wired Bundle — All

Digit 35 — Smart Flow Control

X = None
T = Variable Primary Flow (Constant Delta T)

Digit 36 — Structural Options

A = Standard Unit Structure

Digit 37 — Appearance Options

X = No Appearance Options
A = Architectural Louvered Panels

Digit 38 — Unit Isolation

X = None
1 = Elastomeric Isolators

Digit 39 — Shipping Package

X = No Shipping Package
F = Shipped with Fork Pocket
T = Tarp Covering Full Unit

Digit 40 — Pump Package

X = No Pump Option
2 = Single Pump, High Pressure, Single VFD
4 = Dual Pump, High Pressure, Dual VFD

Digit 41 — Heat Recovery

X = No Heat Recovery
P = Partial Heat Recovery

Digit 42 — Not Used

X = Selection1

Digit 43 — Special Requirement

0 = None
S = Special Requirement
F = Ship to Final Finisher

Digit 44 — Harmonic Filter

N = No Harmonic Filter

Digit 45 — Wireless Connectivity

X = None
A = Wi-Fi
B = LTE Modem
C = Air-Fi
D = Wi-Fi and LTE Modem
E = Wi-Fi and Air-Fi
F = LTE Modem and Air-Fi
G = Wi-Fi, LTE Modem, and Air-Fi



General Data

Table 1. General data – ACS (IP)

Unit Size (tons)		140	160	180	200	215	230
Refrigerant		R-454B					
Compressor Model							
Quantity	#	4	4	6	6	6	6
Tonnage/ckt ^(a)		30+40	40+40	30+30+30	30+30+40	40+40+30	40+40+40
Evaporator							
Water storage - Standard Cooling	gal	17.4	17.4	17.4	17.4	17.4	21.6
Min. flow ^(b)	gpm	168	192	216	240	258	276
Max. flow ^(b)	gpm	504	576	648	720	774	828
Water storage - Other Applications	gal	14	14	14	14	14	14
Water connection	in.	4	4	4	4	4	4
Max. Water Temperature	°F	105	105	105	105	105	105
Min. Water Pressure	psig	0	0	0	0	0	0
Max. Water Pressure	psig	150	150	150	150	150	150
Condenser							
Quantity of coils	#	8	8	10	10	12	12
Coil length	in.	75	75	75	75	75	75
Coil height	in.	49	49	49	49	49	49
Tube width	in.	1	1	1	1	1	1
Fins per foot	fpf	276	276	276	276	276	276
Fan							
Quantity	#	8	8	10	10	12	12
Diameter	in.	37.5	37.5	37.5	37.5	37.5	37.5
EC - Airflow per fan	cfm	11338	11336	11337	11336	11338	11336
AC - Airflow per fan	cfm	11644	11642	11643	11642	11644	11642
EC Motor Power per motor	HP	2.4	2.4	2.4	2.4	2.4	2.4
AC Motor Power per motor	HP	1.8	1.8	1.8	1.8	1.8	1.8
EC Motor RPM	rpm	820	820	820	820	820	820
EC Tip speed	ft/min	7728	7728	7728	7728	7728	7728
PHR EC Motor RPM	rpm	905	905	905	905	905	905
PHR EC Tip speed	ft/min	8529	8529	8529	8529	8529	8529
AC Motor RPM	rpm	840	840	840	840	840	840
AC Tip speed	ft/min	7916	7916	7916	7916	7916	7916
General Unit							
Refrigerant circuits	#	2	2	2	2	2	2
Capacity steps	%	21-43-71-100	25-50-75-100	17-33-50-67-83-100	15-30-50-65-80-100	14-32-50-64-82-100	17-33-50-67-83-100
Min ambient - low/wide	°F	-20	-20	-20	-20	-20	-20
Min ambient - std/high	°F	32	32	32	32	32	32
Refrig charge/ckt ^(a)	lb	50	54	63	63	75	82
With PHR Refrig charge/ckt ^(a)	lb	69	69	91	91	106	108
Oil charge/ckt ^(a)	gal	3.2	3.2	4.8	4.8	4.8	4.8

Table 1. General data – ACS (IP) (continued)

Unit Size (tons)		140	160	180	200	215	230
With PHR Oil charge/ckt ^(a)	gal	3.5	3.5	5.1	5.1	5.1	5.1
Lower Process Cooling - Oil charge/ckt ^(a)	gal	4	4	6	6	6	6
Partial Heat Recovery							
Water storage	gal	7.4	7.4	10.1	10.1	10.5	10.5
Min. flow ^(b)	gpm	65	68	80	82	86	89
Max. flow ^(b)	gpm	194	205	240	247	258	268
Water connection	in.	2.5	2.5	3	3	3	3

^(a) Data shown for one circuit only. The second circuit always matches.

^(b) Minimum and maximum flow rates apply to constant-flow chilled water system running at AHRI conditions, without freeze inhibitors added to the water loop.

Table 2. General data – ACS (SI)

Unit Size (tons)		140	160	180	200	215	230
Refrigerant		R-454B					
Compressor Model							
Quantity	#	4	4	6	6	6	6
Tonnage/ckt ^(a)		30+40	40+40	30+30+30	30+30+40	40+40+30	40+40+40
Evaporator							
Water storage - Standard Cooling	l	66.0	66.0	66.0	66.0	66.0	81.8
Min. flow ^(b)	l/s	10.6	12.1	13.6	15.1	16.3	17.4
Max. flow ^(b)	l/s	31.8	36.3	40.9	45.4	48.8	52.2
Water storage - Other Applications	l	53	53	53	53	53	53
Water connection	mm	101.6	101.6	101.6	101.6	101.6	101.6
Max. Water Temperature	°C	40.5	40.5	40.5	40.5	40.5	40.5
Min. Water Pressure	kPa	0	0	0	0	0	0
Max. Water Pressure	kPa	1034.2	1034.2	1034.2	1034.2	1034.2	1034.2
Condenser							
Quantity of coils	#	8	8	10	10	12	12
Coil length	mm	1914	1914	1914	1914	1914	1914
Coil height	mm	1252	1252	1252	1252	1252	1252
Tube width	mm	25.4	25.4	25.4	25.4	25.4	25.4
Fins per foot	(fpf)	276	276	276	276	276	276
Fan							
Quantity	#	8	8	10	10	12	12
Diameter	mm	953	953	953	953	953	953
EC - Airflow per fan	m ³ /h	19263	19260	19262	19260	19263	19260
AC - Airflow per fan	m ³ /h	19783	19780	19782	19780	19783	19780
EC Motor Power per motor	kW	1.8	1.8	1.8	1.8	1.8	1.8
AC Motor Power per motor	Kw	1.3	1.3	1.3	1.3	1.3	1.3
EC Motor RPM	rpm	820	820	820	820	820	820
EC Tip speed	m/s	39.3	39.3	39.3	39.3	39.3	39.3
PHR EC Motor RPM	rpm	905	905	905	905	905	905
PHR EC Tip speed	m/s	43	43	43	43	43	43
AC Motor RPM	rpm	840	840	840	840	840	840



General Data

Table 2. General data – ACS (SI) (continued)

Unit Size (tons)		140	160	180	200	215	230
AC Tip speed	m/s	40	40	40	40	40	40
General Unit							
Refrigerant circuits	#	2	2	2	2	2	2
Capacity steps	%	21-43- 71-100	25-50- 75-100	17-33-50- 67-83-100	15-30-50- 65-80-100	14-32-50- 64-82-100	17-33-50- 67-83-100
Min ambient - low/wide	°C	-29	-29	-29	-29	-29	-29
Min ambient - std/high	°C	0	0	0	0	0	0
Refrig charge/ckt ^(a)	kg	22.5	24.5	28.5	28.5	34.0	37.0
With PHR Refrig charge/ckt ^(a)	kg	31	31	41	41	48	49
Oil charge/ckt ^(a)	l	12	12	18	18	18	18
With PHR Oil charge/ckt ^(a)	l	13	13	19	19	19	19
Lower Process Cooling - Oil charge/ckt ^(a)	l	15	15	22.5	22.5	22.5	22.5
Partial Heat Recovery							
Water storage	l	28.0	28.0	38.2	38.2	39.9	39.9
Min. flow ^(b)	l/s	4.1	4.3	5.0	5.2	5.4	5.6
Max. flow ^(b)	l/s	12.2	12.9	15.1	15.6	16.3	16.9
Water connection	mm	63.5	63.5	76.2	76.2	76.2	76.2

^(a) Data shown for one circuit only. The second circuit always matches.

^(b) Minimum and maximum flow rates apply to constant-flow chilled water system running at AHRI conditions, without freeze inhibitors added to the water loop.

Table 3. General data – ACX (I-P)

Unit Size (Tons)		080	100	120	140	160	180	200	215	230
Refrigerant		R-454B								
Compressor Model										
Quantity	#	4	4	4	4	4	6	6	6	6
Tonnage/ckt ^(a)		20+20	25+25	30+30	30+40	40+40	30+30+30	30+30+40	40+40+30	40+40+40
Evaporator										
Water storage	gal	10.6	14	14	17.4	17.4	17.4	17.4	17.4	21.6
Water storage - Ice Making	gal	10.6	14	14	14	14	14	14	14	14
Min. flow ^(b) Cooling	gpm	96	120	144	168	192	216	240	258	276
Min. flow Heating	gpm	66	80	100	168	192	216	240	258	276
Max. flow ^(b)	gpm	300	360	450	504	576	648	720	774	828
Water connection	in.	4	4	4	4	4	4	4	4	4
Max. Water Temperature	°F	150	150	150	150	150	150	150	150	150
Min. Water Pressure	psig	0	0	0	0	0	0	0	0	0
Max. Water Pressure	psig	150	150	150	150	150	150	150	150	150
Condenser										
Quantity of coils	#	6	8	8	8	8	10	10	12	12
Coil length	in.	83.6	83.6	83.6	83.6	83.6	83.6	83.6	83.6	83.6
Coil height	in.	49.2	49.2	49.2	49.2	49.2	49.2	49.2	49.2	49.2
Coil width	in.	3.4	3.4	3.4	3.4	3.4	3.4	3.4	3.4	3.4
Fins per foot	fpf	180	180	180	180	180	180	180	180	180
Fans										
Quantity	#	6	8	8	8	8	10	10	12	12
Diameter	in.	37.5	37.5	37.5	37.5	37.5	37.5	37.5	37.5	37.5
Airflow per fan - cooling mode	cfm	12288	12288	12288	12288	12288	12288	12288	12288	12288
Airflow per fan - heating mode	cfm	10510	10510	10510	10510	10510	10510	10510	10510	10510
Power per motor cooling mode	HP	1.7	1.7	1.7	1.7	1.7	1.7	1.7	1.7	1.7
Power per motor heating mode	HP	1.5	1.5	1.5	1.5	1.5	1.5	1.5	1.5	1.5
Motor RPM - cooling mode	rpm	820	820	820	820	820	820	820	820	820
Motor RPM - heating mode	rpm	740	740	740	740	740	740	740	740	740
Tip speed cooling mode	ft/min	7728	7728	7728	7728	7728	7728	7728	7728	7728
Tip speed heating mode	ft/min	6785	6785	6785	6785	6785	6785	6785	6785	6785
General Unit										
Capacity steps	%	25-50-75-100	25-50-75-100	25-50-75-100	21-43-71-100	25-50-75-100	17-33-50-67-83-100	15-30-50-65-80-100	14-32-50-64-82-100	17-33-50-67-83-100
Min. ambient - heating mode	°F	-15	-15	-15	0	0	0	0	0	0
Max. ambient - heating mode	°F	95	95	95	95	95	95	95	95	95
Min. ambient - cooling mode	°F	-4	-4	-4	-4	-4	-4	-4	-4	-4
Max. ambient - cooling mode	°F	125	125	125	125	125	125	125	125	125
Refrigerant charge/ckt										
R-454B ^(a)	lb	92	115	115	121	121	163	163	187	189
Oil charge/ckt ^(a)	gal	4.6	5.1	5.1	5.1	5.1	7	7	7	7

^(a) Data shown for one circuit only. The second circuit always matches.

^(b) Minimum and maximum flow rates apply to constant-flow chilled water system running at AHRI conditions, without freeze inhibitors added to the water loop.



General Data

Table 4. General data – ACX (SI)

Unit Size (Tons)		080	100	120	140	160	180	200	215	230
Refrigerant		R-454B								
Compressor Model										
Quantity	#	4	4	4	4	4	6	6	6	6
Tonnage/ckt ^(a)		20+20	25+25	30+30	30+40	40+40	30+30+30	30+30+40	40+40+30	40+40+40
Evaporator										
Water storage	l	40.2	53	53	65.9	65.9	65.9	65.9	65.9	81.8
Water storage - Ice Making	l	40.2	53	53	53	53	53	53	53	53
Min. flow ^(b) Cooling	l/s	6.1	7.6	9.1	10.6	12.1	13.6	15.1	16.3	17.4
Min. flow Heating	l/s	4.2	5.0	6.3	10.6	12.1	13.6	15.1	16.3	17.4
Max. flow ^(b)	l/s	18.9	22.7	28.4	31.8	36.3	40.9	45.4	48.8	52.2
Water connection	mm	101.6	101.6	101.6	101.6	101.6	101.6	101.6	101.6	101.6
Max. Water Temperature	°C	65.5	65.5	65.5	65.5	65.5	65.5	65.5	65.5	65.5
Min. Water Pressure	kPa	0	0	0	0	0	0	0	0	0
Max. Water Pressure	kPa	1034.2	1034.2	1034.2	1034.2	1034.2	1034.2	1034.2	1034.2	1034.2
Condenser										
Quantity of coils	#	6	8	8	8	8	10	10	12	12
Coil length	mm	2123	2123	2123	2123	2123	2123	2123	2123	2123
Coil height	mm	1250	1250	1250	1250	1250	1250	1250	1250	1250
Coil width	mm	86	86	86	86	86	86	86	86	86
Fins per foot	fpf	180	180	180	180	180	180	180	180	180
Fans										
Quantity	#	6	8	8	8	8	10	10	12	12
Diameter	mm	953	953	953	953	953	953	953	953	953
Airflow per fan - cooling mode	m ³ /h	20877	20877	20877	20877	20877	20877	20877	20877	20877
Airflow per fan - heating mode	m ³ /h	17856	17856	17856	17856	17856	17856	17856	17856	17856
Power per motor cooling mode	kW	1.3	1.3	1.3	1.3	1.3	1.3	1.3	1.3	1.3
Power per motor heating mode	kW	1.1	1.1	1.1	1.1	1.1	1.1	1.1	1.1	1.1
Motor RPM - cooling mode	rpm	820	820	820	820	820	820	820	820	820
Motor RPM - heating mode	rpm	740	740	740	740	740	740	740	740	740
Tip speed cooling mode	m/s	39.3	39.3	39.3	39.3	39.3	39.3	39.3	39.3	39.3
Tip speed heating mode	m/s	34.5	34.5	34.5	34.5	34.5	34.5	34.5	34.5	34.5
General Unit										
Refrigerant circuits	#	2	2	2	2	2	2	2	2	2
Capacity steps	%	25-50-75-100	25-50-75-100	25-50-75-100	21-43-71-100	25-50-75-100	17-33-50-67-83-100	15-30-50-65-80-100	14-32-50-64-82-100	17-33-50-67-83-100
Min. ambient - heating mode	°C	-26	-26	-26	-18	-18	-18	-18	-18	-18
Max. ambient - heating mode	°C	35	35	35	35	35	35	35	35	35
Min. ambient - cooling mode	°C	-20	-20	-20	-20	-20	-20	-20	-20	-20
Max. ambient - cooling mode	°C	52	52	52	52	52	52	52	52	52
Refrig charge/ckt										
R-454B ^(a)	kg	42	52	52	55	55	74	74	85	86
Oil charge/ckt ^(a)	l	17.4	19.3	19.3	19.3	19.3	26.5	26.5	26.5	26.5

^(a) Data shown for one circuit only. The second circuit always matches.

^(b) Minimum and maximum flow rates apply to constant-flow chilled water system running at AHRI conditions, without freeze inhibitors added to the water loop.



Controls

Symbio™ 800 Controller

Trane Ascend™ chillers offer predictive controls that anticipate and compensate for load changes. Other strategies made possible with the Symbio™ 800 controls are:

Feedforward Adaptive Control

Feedforward is an open-loop, predictive control strategy designed to anticipate and compensate for load changes. It uses evaporator entering-water temperature as an indication of load change. This allows the controller to respond faster and maintain stable leaving-water temperatures.

Adaptive Controls

Adaptive Controls directly sense the control variables that govern the operation of the chiller: evaporator pressure and condenser pressure. When any one of these variables approaches a limit condition when damage may occur to the unit or shutdown on a safety, Adaptive Controls takes corrective action to avoid shutdown and keep the chiller operating. This happens through combined actions of compressor and/or fan staging. Whenever possible, the chiller is allowed to continue making chilled water. This keeps cooling capacity available until the problem can be solved. Overall, the safety controls help keep the building or process running and out of trouble.

Integrated Rapid Restart

Bringing a chiller back online rapidly after a loss of power is critical to operations in mission critical environments like data centers and hospitals which demand the highest levels of reliability.

A loss of cooling capacity can be costly, which is why Trane chillers are designed and engineered for Rapid Restart™. In the event of a power interruption, the chiller will start a compressor before the front panel display is fully powered up eliminating the need for UPS. This not only helps the chiller get back online faster, but it also provides a simple and reliable solution to minimize the risks of financially devastating damage to assets caused by overheating due to a power loss.

Of course, the truest test of a chiller's restart capabilities is the amount of time it takes to resume full-load cooling, and this is where the chiller really shines. An 80 percent cooling load can be achieved in less than 2.5 minutes after power restoration—your assurance that the cooling capacity your equipment requires is just a few minutes away.

AdaptiView™ TD7 Display

The standard AdaptiView™ TD7 display provided with the Symbio™ 800 controller features a 7" LCD touch-screen, allowing access to all operational inputs and outputs. This is an advanced interface that allows the user to access any important information concerning setpoints, active temperatures, modes, electrical data, pressure, and diagnostics. It uses full text display available in 27 languages.

Display Features Include:

- LCD touch-screen with LED backlighting, for scrolling access to input and output operating information.
- Single-screen, folder/tab-style display of all available information on individual subcomponents (evaporator, condenser, compressor)
- Manual override indication.
- Password entry/lockout system to enable or disable display.
- Automatic and immediate stop capabilities for standard or immediate manual shutdown.
- Fast, easy access to available chiller data in tabbed format, including:
 - Easy to view Operating Modes.
 - Logical Sub-Component Reports:
 - Evaporator.
 - Condenser.

- Compressor.
- 3 User Programmable Custom Reports.
- ASHRAE Report.
- Log Sheet Report.
- Alarms Report.
- 8 pre-defined Standard Graphs.
- 4 User Programmable Custom Graphs.
- Unit Settings.
- Service Settings.
- Feature Settings.
- Chilled/Hot Water Reset.
- Manual Control Settings.
- Display Preferences.
- Support of 27 languages.
- Brightness Setting.
- Cleaning Mode.

System Integration

Adaptive™ Control

Adaptive™ Control directly senses the control variables that govern the operation of the chiller: evaporator pressure and condenser pressure. When any one of these variables approaches a limit condition at which damage may occur to the unit or it may shutdown on a safety, Adaptive™ Control takes corrective action to avoid shutdown and keep the chiller operating. This happens through combined actions of compressor and/or fan staging. Whenever possible, the chiller is allowed to continue making chilled or hot water. This keeps cooling capacity available until the problem can be solved. Overall, the safety controls help keep the building or process running smoothly.

Stand-Alone Controls

Single chillers installed in applications without a building management system are simple to install and control: only a remote auto/stop for scheduling is required for unit operation. Signals from the chilled-water pump contactor auxiliary, or a flow switch, are wired to the chilled-water flow interlock. Signals from a time clock or some other remote device are wired to the external auto/stop input.

- Auto/Stop - A job-site provided contact closure turns the unit on and off.
- Emergency Stop - A job-site provided contact opening wired to this input turns the unit off and requires a manual reset of the unit microcomputer. This closure is typically triggered by a job-site provided system such as a fire alarm.

Hardwire Points

Microcomputer controls allow simple interface with other control systems, such as time clocks, building automation systems, and ice storage systems via hardwire points. This means you have the flexibility to meet job requirements while not having to learn a complicated control system.

Remote devices are wired from the control panel to provide auxiliary control to a building automation system. Inputs and outputs can be communicated via a typical 4–20 mA electrical signal, an equivalent 2–10 Vdc signal, or by utilizing contact closures.

This setup has the same features as a stand-alone water chiller, with the possibility of having additional optional features:

- Ice making control.
- External chilled water setpoint, external demand limit setpoint.
- Chilled water temperature reset.

- Programmable relays - available outputs are: Latching alarm, Non-latching alarm, Alarm, Alarm ckt1, Alarm ckt2, Chiller limit mode, Compressor running, Ckt1 running, Ckt2 running, Warning, Maximum capacity, Evaporator freeze avoidance request, Service request, Ice making status, Refrigerant charge loss detected, Hot water control status and Defrost status.

Overview

The Symbio™ 800 controller is a factory-installed, application specific and programmable controller designed to control chillers and large packaged HVAC equipment. A 7-inch user interface features a touch-sensitive color screen that provides facility managers at-a-glance operating status, performance monitoring, scheduling changes, and operating adjustments. Other advanced features include automated controller back-up, and optional features such as secure remote connectivity, wireless building communications, mobile device connectivity, and custom programming with expandable I/O.

Symbio™ 800 Advantages		Benefits
Connected	Convenient, on-the-go access to advanced monitoring, troubleshooting, and energy management	<ul style="list-style-type: none"> • Minimum first cost. • Maximum comfort. • Minimized downtime. • Minimum operating costs. • Superior building and occupant productivity.
Flexible	Minimized installation hardware and labor costs – able to use existing devices for maximum convenience, lower controls upgrades and relocation	
Reliable	Maximum equipment uptime and life, minimized maintenance and troubleshooting cost	

Features and Benefits

Symbio™ 800 Feature	Benefits
Multiple, open standard protocol support <ul style="list-style-type: none"> • BACnet® TP. • BACnet®/IP. • LON (Optional). • Modbus®. 	Simplified, lower cost, and more flexible integration with all common open standard protocols using Trane or competitive BAS systems and controllers.
Remote connection to building or equipment	Trane Connect™ provides an easy, secure option to connect remotely to a Tracer® SC+ or directly to your Trane equipment.
Common integration strategies and equipment specific points lists	Simplified, lower cost, and uncompromised integration.
Application specific and configurable	Reduced project costs with superior reliability, comfort, performance - applications specific and configurable system confirms machine continues to run within operating envelope. Ability to upgrade firmware with a simple file transfer.
Smart Analytics	Smart analytics provide superior reliability through the life of the equipment with minimum downtime.
Data logging	Standard, local or remote Intuitive review and analysis of equipment, zone, and building performance.
Local scheduling	Capable of operating in stand-alone operation without a building automation system as a temporary back-up schedule for ongoing comfort and energy savings.
Rugged, 7-inch color touch screen user interface	Easy, touch navigation for viewing data and making operational changes.
Display preferences	Choose how to view dates, times, units (SI, IP), screen brightness, data format, and backlight timeout. A total of 27 built-in languages are supported and selectable for all TD-7 screens.
Intuitive navigation	Helps operators access data and alarms for quick and accurate response and resolution.
At-a-glance status	Easily readable color display showing key operating parameters of major equipment components.
Reports	Quickly summarizes data for clear understanding and interpretation to enable local monitoring of expected performance and operating efficiency.
Graphs	Easily visualize trend data for local troubleshooting and fine-tuning.
Multiple language support	Suitable for operation in multiple geographies.



Controls

Symbio™ 800 Feature	Benefits
Adaptive Control™ Algorithms	Pre-empts potential equipment disruptions during rapidly changing conditions – providing consistent equipment performance and building comfort.
SD card backup/restore	Faster, lower cost repairs with reduced downtime.
Modbus® device support	Capable of integrating optional Modbus® devices for local or remote diagnostics — provides faster, lower cost troubleshooting and increased equipment performance.

Options

Symbio™ 800 Feature	Benefits
Remote connection to building or equipment	Trane Connect™ provides an easy, secure option to connect remotely to a Tracer® SC+ or directly to your Trane equipment.
Programmable	Equipment application flexibility and cost-reduced control of nearby equipment.
Expandable I/O	Field or factory installed I/O for programmable feature for reduced installation costs and increased installation flexibility.
User security with audit trail support	Flexible and secure access for multiple users allows monitoring, overriding/releasing points, release of all overrides, custom report editing, and tracking changes by user.
LonTalk®	

BACnet® Building Automation Control Network

The BACnet® control network for Symbio™ 800 expands communications from the unit UCM network to the Tracer® Ensemble™ or Tracer® SC+ building automation system or third party building automation system.

Utilizing BACnet®, the BAS allows external setpoint and configuration adjustment and monitoring of status and diagnostics. The Symbio™ 800 utilizes the BACnet® defined MS/TP protocol as defined in ASHRAE standard 135-2004.

This controller works in standalone mode, with Tracer® Ensemble™, Tracer® SC+ or when connected to a third party building automation system that supports BACnet®.

LonTalk® Building Automation Systems

The LonTalk® communication protocol for the Symbio™ 800 controller expands communications from the unit UCM network to a Tracer® Ensemble™ building automation system or third party building automation system. Utilizing LonTalk®, the BAS allows external setpoint and configuration adjustment and monitoring of status and diagnostics. The Symbio™ 800 utilizes an FTT-10A free topology transceiver, which supports non-polarity sensitive, free topology wiring—which in turn allows the system installer to utilize star, bus, and loop architectures. This controller works in standalone mode, peer-to-peer with one or more other units, or when connected to a Tracer® Ensemble™, Tracer® SC+, or a third party building automation system that supports LonTalk®.

Modbus® Automation Control Network

Allows the user to easily interface with Modbus® RTU communication protocol via a single twisted pair wiring from the Symbio™ 800 controller to a factory installed device.

Tracer® SC

The Tracer® SC system controller acts as the central coordinator for all individual equipment devices on a Tracer® building automation system. The Tracer®SC scans all unit controllers to update information and coordinate building control, including building subsystems such as VAV and chiller water systems. With this system option, the full breadth of Trane's HVAC and controls experience are applied to offer solutions to many facility issues. The LAN allows building operators to manage these varied components as one system from any personal computer with web access. The benefits of this system are:

- Improved usability with automatic data collection, enhanced data logging, easier to create graphics, simpler navigation, pre-programmed scheduling, reporting, and alarm logs.

- Flexible technology allows for system sizes from 30 to 120 unit controllers with any combination of LonTalk® or BACnet® unit controllers.
- LEED certification through site commissioning report, energy data collection measurement, optimizing energy performance, and maintaining indoor air quality.

Energy savings programs include: fan pressure optimization, ventilation reset, and chiller plant control (adds and subtracts chillers to meet cooling loads).

Building Automation and Chiller Plant Control

The Symbio™ 800 controller can communicate with Trane Tracer® SC and Tracer® ES building automation systems, which include pre-engineered and flexible control for chiller plants. These building automation systems can control the operation of the complete installation: chillers, pumps, isolating valves, air handlers, and terminal units. Trane can undertake full responsibility for optimized automation and energy management for the entire chiller plant. The main functions are:

- **Chiller sequencing:** equalizes the number of running hours of the chillers. Different control strategies are available depending on the configuration of the installation.
- **Control of the auxiliaries:** includes input/output modules to control the operation of the various auxiliary equipment (water pumps, valves, etc.)
- **Time-of-day scheduling:** allows the end user to define the occupancy period, for example: time of the day, holiday periods and exception schedules.
- **Optimization of the installation start/stop time:** based on the programmed schedule of occupancy and the historical temperature records. Tracer SC calculates the optimal start/stop time of the installation to get the best compromise between energy savings and comfort of the occupants.
- **Communication capabilities:** local, through a PC workstation keyboard. Tracer® SC can be programmed to send messages to other local or remote workstations and or a pager in the following cases:
 - Analog parameter exceeding a programmed value
 - Maintenance warning
 - Component failure alarm
 - Critical alarm messages. In this latter case, the message is displayed until the operator acknowledges the receipt of the information. From the remote station it is also possible to access and modify the chiller plants control parameters.
- **Remote communication through a modem:** as an option, a modem can be connected to communicate the plant operation parameters through voice grade phone lines. A remote terminal is a PC workstation equipped with a modem and software to display the remote plant parameters.

Integrated Comfort System (ICS)

The onboard chiller controller is designed to be able to communicate with a wide range of building automation systems. In order to take full advantage of chiller's capabilities, incorporate your chiller into a Tracer® SC building automation system.

But the benefits do not stop at the chiller plant. At Trane, we realize that all the energy used in your cooling system is important. That is why we worked closely with other equipment manufacturers to predict the energy required by the entire system. We used this information to create patented control logic for optimizing HVAC system efficiency.

The building owners challenge is to tie components and applications expertise into a single reliable system that provides maximum comfort, control, and efficiency. Trane® Integrated Comfort systems (ICS) are a concept that combines system components, controls, and engineering applications expertise into a single, logical, and efficient system. These advanced controls are fully commissioned and available on every piece of Trane equipment, from the largest chiller to the smallest VAV box. As a manufacturer, only Trane offers this universe of equipment, controls, and factory installation and verification.



Electrical Data

Table 5. Electrical data — RLA and LRA information

Unit Size	Rated Voltage ^(a)	RLA						LRA					
		Compressor (Circuit 1)			Compressor (Circuit 2)			Compressor (Circuit 1)			Compressor (Circuit 2)		
		1A	1B	1C	2A	2B	2C	1A	1B	1C	2A	2B	2C
80	200/60/3	75	75	-	75	75	-	455	455	-	455	455	-
	230/60/3	75	75	-	75	75	-	455	455	-	455	455	-
	460/60/3	35	35	-	35	35	-	230	230	-	230	230	-
	575/60/3	29	29	-	29	29	-	175	175	-	175	175	-
100	200/60/3	88	88	-	88	88	-	600	600	-	600	600	-
	230/60/3	88	88	-	88	88	-	600	600	-	600	600	-
	460/60/3	42	42	-	42	42	-	290	290	-	290	290	-
	575/60/3	33	33	-	33	33	-	220	220	-	220	220	-
120	200/60/3	119	119	-	119	119	-	735	735	-	735	735	-
	230/60/3	119	119	-	119	119	-	735	735	-	735	735	-
	460/60/3	54	54	-	54	54	-	310	310	-	310	310	-
	575/60/3	44	44	-	44	44	-	260	260	-	260	260	-
140	200/60/3	119	150	-	119	150	-	717	761	-	717	761	-
	230/60/3	119	150	-	119	150	-	717	761	-	717	761	-
	380/60/3	69	83	-	69	83	-	424	475	-	424	475	-
	400/60/3	66	79	-	66	79	-	424	475	-	424	475	-
	460/60/3	54	69	-	54	69	-	294	389	-	294	389	-
	575/60/3	44	55	-	44	55	-	235	296	-	235	296	-
160	200/60/3	150	150	-	150	150	-	761	761	-	761	761	-
	230/60/3	150	150	-	150	150	-	761	761	-	761	761	-
	380/60/3	83	83	-	83	83	-	475	475	-	475	475	-
	400/60/3	79	79	-	79	79	-	475	475	-	475	475	-
	460/60/3	69	69	-	69	69	-	389	389	-	389	389	-
	575/60/3	55	55	-	55	55	-	296	296	-	296	296	-
180	200/60/3	119	119	119	119	119	119	717	717	717	717	717	717
	230/60/3	119	119	119	119	119	119	717	717	717	717	717	717
	380/60/3	69	69	69	69	69	69	424	424	424	424	424	424
	400/60/3	66	66	66	66	66	66	424	424	424	424	424	424
	460/60/3	54	54	54	54	54	54	294	294	294	294	294	294
	575/60/3	44	44	44	44	44	44	235	235	235	235	235	235
200	200/60/3	119	119	150	119	119	150	717	717	761	717	717	761
	230/60/3	119	119	150	119	119	150	717	717	761	717	717	761
	380/60/3	69	69	83	69	69	83	424	424	475	424	424	475
	400/60/3	66	66	79	66	66	79	424	424	475	424	424	475
	460/60/3	54	54	69	54	54	69	294	294	389	294	294	389
	575/60/3	44	44	55	44	44	55	235	235	296	235	235	296

Table 5. Electrical data — RLA and LRA information (continued)

Unit Size	Rated Voltage ^(a)	RLA						LRA					
		Compressor (Circuit 1)			Compressor (Circuit 2)			Compressor (Circuit 1)			Compressor (Circuit 2)		
		1A	1B	1C	2A	2B	2C	1A	1B	1C	2A	2B	2C
215	200/60/3	150	150	119	150	150	119	761	761	717	761	761	717
	230/60/3	150	150	119	150	150	119	761	761	717	761	761	717
	380/60/3	83	83	69	83	83	69	475	475	424	475	475	424
	400/60/3	79	79	66	79	79	66	475	475	424	475	475	424
	460/60/3	69	69	54	69	69	54	389	389	294	389	389	294
	575/60/3	55	55	44	55	55	44	296	296	235	296	296	235
230	200/60/3	150	150	150	150	150	150	761	761	761	761	761	761
	230/60/3	150	150	150	150	150	150	761	761	761	761	761	761
	380/60/3	83	83	83	83	83	83	475	475	475	475	475	475
	400/60/3	79	79	79	79	79	79	475	475	475	475	475	475
	460/60/3	69	69	69	69	69	69	389	389	389	389	389	389
	575/60/3	55	55	55	55	55	55	296	296	296	296	296	296

^(a) Voltage Utilization Range: +/- 10% of Rated voltage (use range): 200/60/3 (187-229), 230/60/3 (207-253), 380/60/3 (342-418), 400/60/3 (360-440), 460/60/3 (414-506), 575/60/3 (517-633)

Table 6. Electrical data — condenser fan information, MCA and MOP values

Unit Size	Rated Voltage ^(a)	Compr Qty	Condenser Fans						CPT Amps	No Pump			Pump		
			Qty ^(b)	EC Motor		AC Motor		MCA		MOP	MCA		MOP		
				HP	FLA	HP	FLA	EC Fan			AC Fan	EC Fan		AC Fan	
															HP
80	200/60/3	4	3/3	2.5	3.2	-	-	5.6	363	-	400	417	-	450	
	230/60/3	4	3/3	2.5	2.8	-	-	4.8	357	-	400	411	-	450	
	460/60/3	4	3/3	2.5	2.8	-	-	2.4	168	-	200	197	-	225	
	575/60/3	4	3/3	2.5	2.8	-	-	1.9	139	-	175	160	-	200	
100	200/60/3	4	4/4	2.5	3.2	-	-	5.6	431	-	500	485	-	600	
	230/60/3	4	4/4	2.5	2.8	-	-	4.8	424	-	500	478	-	600	
	460/60/3	4	4/4	2.5	2.8	-	-	2.4	203	-	250	232	-	250	
	575/60/3	4	4/4	2.5	2.8	-	-	1.9	160	-	200	181	-	200	
120	200/60/3	4	4/4	2.5	3.2	-	-	5.6	563	-	600	631	-	700	
	230/60/3	4	4/4	2.5	2.8	-	-	4.8	555	-	600	623	-	700	
	460/60/3	4	4/4	2.5	2.8	-	-	2.4	254	-	300	288	-	350	
	575/60/3	4	4/4	2.5	2.8	-	-	1.9	207	-	250	232	-	250	
140	200/60/3	4	4/4	2.4	2.7	-	-	5.6	627	-	700	687	-	800	
	230/60/3	4	4/4	2.4	2.5	-	-	4.8	623	-	700	683	-	800	
	380/60/3	4	4/4	2.4	2.9	-	-	2.9	353	-	400	-	-	-	
	400/60/3	4	4/4	2.4	2.7	-	-	2.8	336	-	400	-	-	-	
	460/60/3	4	4/4	2.4	2.5	1.8	3.7	2.4	287	297	350	317	326	400	
	575/60/3	4	4/4	2.4	2.5	-	-	1.9	231	-	300	254	-	300	



Electrical Data

Table 6. Electrical data — condenser fan information, MCA and MOP values (continued)

Unit Size	Rated Voltage ^(a)	Compr Qty	Condenser Fans					CPT Amps	No Pump			Pump		
			Qty ^(b)	EC Motor		AC Motor			MCA		MOP	MCA		MOP
				HP	FLA	HP	FLA		EC Fan	AC Fan		EC Fan	AC Fan	
160	200/60/3	4	4/4	2.4	2.7	-	-	5.6	689	-	800	749	-	1000
	230/60/3	4	4/4	2.4	2.5	-	-	4.8	685	-	800	745	-	1000
	380/60/3	4	4/4	2.4	2.9	-	-	2.9	381	-	450	-	-	-
	400/60/3	4	4/4	2.4	2.7	-	-	2.8	362	-	400	-	-	-
	460/60/3	4	4/4	2.4	2.5	1.8	3.7	2.4	317	327	400	347	356	400
	575/60/3	4	4/4	2.4	2.5	-	-	1.9	253	-	300	276	-	300
180	200/60/3	6	5/5	2.4	2.7	-	-	5.6	808	-	1000	868	-	1000
	230/60/3	6	5/5	2.4	2.5	-	-	4.8	803	-	1000	862	-	1000
	380/60/3	6	5/5	2.4	2.9	-	-	2.9	466	-	500	-	-	-
	400/60/3	6	5/5	2.4	2.7	-	-	2.8	445	-	500	-	-	-
	460/60/3	6	5/5	2.4	2.5	1.8	3.7	2.4	367	379	450	397	409	450
	575/60/3	6	5/5	2.4	2.5	-	-	1.9	299	-	350	322	-	350
200	200/60/3	6	5/5	2.4	2.7	-	-	5.6	878	-	1000	937	-	1000
	230/60/3	6	5/5	2.4	2.5	-	-	4.8	873	-	1000	932	-	1000
	380/60/3	6	5/5	2.4	2.9	-	-	2.9	497	-	600	-	-	-
	400/60/3	6	5/5	2.4	2.7	-	-	2.8	474	-	500	-	-	-
	460/60/3	6	5/5	2.4	2.5	1.8	3.7	2.4	401	413	500	430	442	500
	575/60/3	6	5/5	2.4	2.5	-	-	1.9	323	-	400	347	-	400
215	200/60/3	6	6/6	2.4	2.7	-	-	5.6	951	-	1000	1022	-	1200
	230/60/3	6	6/6	2.4	2.5	-	-	4.8	945	-	1000	1016	-	1200
	380/60/3	6	6/6	2.4	2.9	-	-	2.9	531	-	600	-	-	-
	400/60/3	6	6/6	2.4	2.7	-	-	2.8	505	-	600	-	-	-
	460/60/3	6	6/6	2.4	2.5	1.8	3.7	2.4	436	450	500	471	486	600
	575/60/3	6	6/6	2.4	2.5	-	-	1.9	349	-	400	378	-	450
230	200/60/3	6	6/6	2.4	2.7	-	-	5.6	1013	-	1200	-	-	-
	230/60/3	6	6/6	2.4	2.5	-	-	4.8	1007	-	1200	-	-	-
	380/60/3	6	6/6	2.4	2.9	-	-	2.9	559	-	600	-	-	-
	400/60/3	6	6/6	2.4	2.7	-	-	2.8	531	-	600	-	-	-
	460/60/3	6	6/6	2.4	2.5	1.8	3.7	2.4	466	480	500	501	516	600
	575/60/3	6	6/6	2.4	2.5	-	-	1.9	371	-	450	400	-	450

^(a) Voltage Utilization Range: +/- 10% of Rated voltage (use range): 200/60/3 (187-229), 230/60/3 (207-253), 380/60/3 (342-418), 400/60/3 (360-440), 460/60/3 (414-506), 575/60/3 (517-633)

^(b) Values are shown as circuit 1/circuit 2.

Table 7. Customer wire selection (continued)

Unit Size	Rated Voltage	No Pump						Pump ^(a)			
		Terminal Block	SCCR	Circuit Breaker	Standard Fault SCCR	Circuit Breaker	High Fault SCCR	Circuit Breaker	Standard Fault SCCR	Circuit Breaker	High Fault SCCR
200	200/60/3	(4) #2 - 600 MCM	10kA	(4) 4/0 - 500 MCM	10kA	(4) 3/0 - 500 MCM	65kA	(4) 4/0 - 500 MCM	10kA	(4) 3/0 - 500 MCM	65kA
	230/60/3	(4) #2 - 600 MCM	10kA	(4) 4/0 - 500 MCM	10kA	(4) 3/0 - 500 MCM	65kA	(4) 4/0 - 500 MCM	10kA	(4) 3/0 - 500 MCM	65kA
	380/60/3	(2) #4 - 500 MCM	10kA	(3) 2/0 - 400 MCM	10kA	(4) 3/0 - 500 MCM	65kA	-	-	-	-
	400/60/3	(2) #4 - 500 MCM	10kA	(2) 2/0 - 500 MCM	10kA	(2) 2/0 - 500 MCM	65kA	-	-	-	-
	460/60/3	(2) #4 - 500 MCM	10kA	(2) 2/0 - 500 MCM	10kA	(2) 2/0 - 500 MCM	65kA	(2) 2/0 - 500 MCM	10kA	(2) 2/0 - 500 MCM	65kA
	575/60/3	(2) #4 - 500 MCM	10kA	(2) 2/0 - 500 MCM	10kA	(2) 2/0 - 500 MCM	25kA	(2) 2/0 - 500 MCM	10kA	(2) 2/0 - 500 MCM	25kA
215	200/60/3	(4) #2 - 600 MCM	10kA	(4) 4/0 - 500 MCM	10kA	(4) 3/0 - 500 MCM	65kA	(4) 4/0 - 500 MCM	10kA	(4) 3/0 - 500 MCM	65kA
	230/60/3	(4) #2 - 600 MCM	10kA	(4) 4/0 - 500 MCM	10kA	(4) 3/0 - 500 MCM	65kA	(4) 4/0 - 500 MCM	10kA	(4) 3/0 - 500 MCM	65kA
	380/60/3	(2) #4 - 500 MCM	10kA	(3) 2/0 - 400 MCM	10kA	(4) 3/0 - 500 MCM	65kA	-	-	-	
	400/60/3	(2) #4 - 500 MCM	10kA	(3) 2/0 - 400 MCM	10kA	(4) 3/0 - 500 MCM	65kA	-	-	-	
	460/60/3	(2) #4 - 500 MCM	10kA	(2) 2/0 - 500 MCM	10kA	(2) 2/0 - 500 MCM	65kA	(3) 2/0 - 400 MCM	10kA	(4) 3/0 - 500 MCM	65kA
	575/60/3	(2) #4 - 500 MCM	10kA	(2) 2/0 - 500 MCM	10kA	(2) 2/0 - 500 MCM	25kA	(2) 2/0 - 500 MCM	10kA	(2) 2/0 - 500 MCM	25kA
230	200/60/3	(4) #2 - 600 MCM	10kA	(4) 4/0 - 500 MCM	10kA	(4) 3/0 - 500 MCM	65kA	(4) 4/0 - 500 MCM	10kA	-	-
	230/60/3	(4) #2 - 600 MCM	10kA	(4) 4/0 - 500 MCM	10kA	(4) 3/0 - 500 MCM	65kA	(4) 4/0 - 500 MCM	10kA	-	-
	380/60/3	(2) #4 - 500 MCM	10kA	(3) 2/0 - 400 MCM	10kA	(4) 3/0 - 500 MCM	65kA	-	-	-	
	400/60/3	(2) #4 - 500 MCM	10kA	(3) 2/0 - 400 MCM	10kA	(4) 3/0 - 500 MCM	65kA	-	-	-	
	460/60/3	(2) #4 - 500 MCM	10kA	(2) 2/0 - 500 MCM	10kA	(2) 2/0 - 500 MCM	65kA	(3) 2/0 - 400 MCM	10kA	(4) 3/0 - 500 MCM	65kA
	575/60/3	(2) #4 - 500 MCM	10kA	(2) 2/0 - 500 MCM	10kA	(2) 2/0 - 500 MCM	25kA	(2) 2/0 - 500 MCM	10kA	(2) 2/0 - 500 MCM	25kA

Note: Field wire insulation temperature rating must be minimum 90°C unless otherwise specified.

^(a) Terminal block is not available on units with optional pump package.



Dimensions and Weights

Unit Dimensions

Standard Unit

ACSA 140 - 230T
INLET/OUTLET CONNECTION 4" (100 mm)

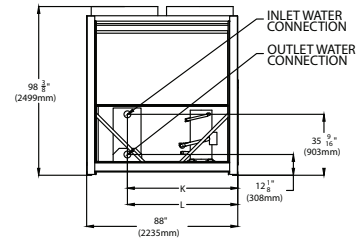
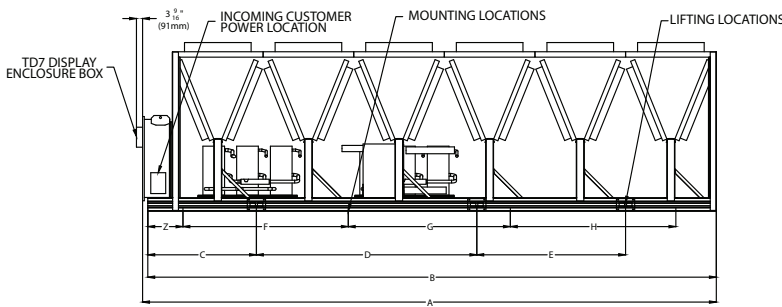
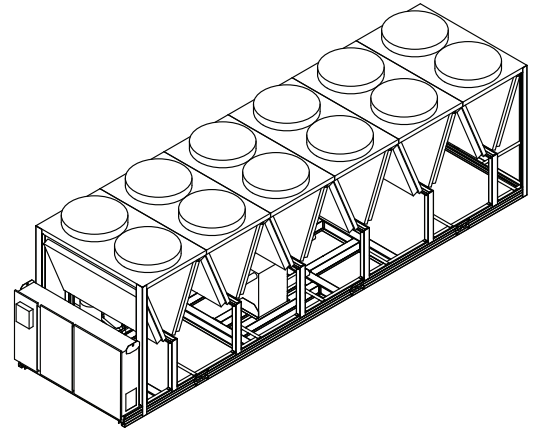
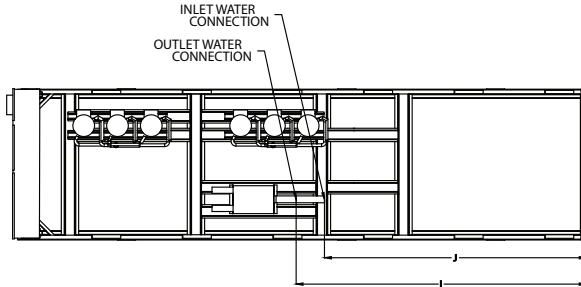

Dim	Unit Size																	
	80		100		120		140		160		180		200		215		230	
	in	mm	in	mm	in	mm	in	mm	in	mm	in	mm	in	mm	in	mm	in	mm
A	176	4469	228.8	5810	228.8	5810	228.8	5810	228.8	5810	281.6	7153	281.6	7153	334.4	8494	334.4	8494
B	173	4393	225.8	5734	225.8	5734	225.8	5734	225.8	5734	278.6	7075	278.6	7075	331.4	8418	331.4	8418
C	48.3	1227	48.3	1227	48.3	1227	48.3	1227	48.3	1227	63.3	1608	63.3	1608	63.3	1608	63.3	1608
D	105.7	2684	124.3	3158	124.3	3158	124.3	3158	124.3	3158	162.1	4116	162.1	4116	128.5	3264	128.5	3264
E	-	-	-	-	-	-	-	-	-	-	-	-	-	-	86.8	2203	86.8	2203
Z	20.4	519	20.4	519	20.4	519	20.4	519	20.4	519	40.1	1019	40.1	1019	40.1	1019	40.1	1019
F	55.1	1400	55.1	1400	55.1	1400	55.1	1400	55.1	1400	76.8	1949	76.8	1949	76.8	1949	76.8	1949
G	59.1	1500	59.1	1500	59.1	1500	59.1	1500	59.1	1500	59.1	1500	59.1	1500	94.5	2400	94.5	2400
H	-	-	55.1	1400	55.1	1400	55.1	1400	55.1	1400	70.9	1800	70.9	1800	96.4	2450	96.4	2450
I	16	406	68.8	1748	68.8	1748	68.8	1748	68.8	1748	104.6	2656	104.6	2656	157.4	3997	157.4	3997
J (ACSA)	-	-	-	-	-	-	64.0	1626	64.0	1626	99.8	2534	99.8	2534	152.6	3875	152.6	3875
J (ACXA)	5.1	129	57.9	1471	57.9	1471	57.9	1471	57.9	1471	93.7	2380	93.7	2380	146.5	3721	146.5	3721
K	64.3	1633	64.3	1633	64.3	1633	64.3	1633	64.3	1633	64.3	1633	64.3	1633	64.3	1633	64.3	1633
L	64.3	1633	64.3	1633	64.3	1633	64.3	1633	64.3	1633	64.3	1633	64.3	1633	64.3	1633	64.3	1633



Dimensions and Weights

Unit with Optional Water Reversing Valve – No Pump

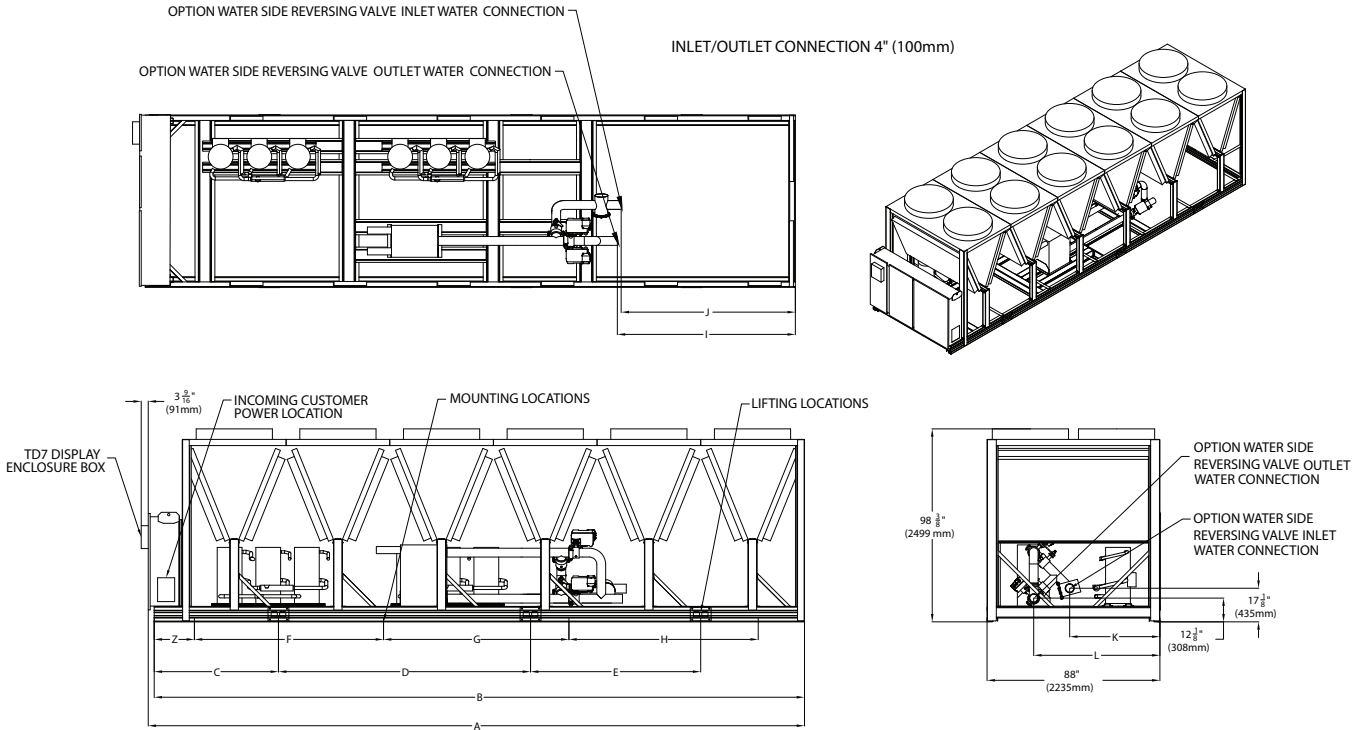

Dim	Unit Size																		
	80		100		120		140		160		180		200		215		230		
	in	mm	in	mm	in	mm	in	mm	in	mm	in	mm	in	mm	in	mm	in	mm	
A	228.8	5810	228.8	5810	228.8	5810	N/A	N/A	N/A	N/A	N/A	N/A	N/A	N/A	N/A	N/A	N/A	N/A	N/A
B	225.8	5734	225.8	5734	225.8	5734	N/A	N/A	N/A	N/A	N/A	N/A	N/A	N/A	N/A	N/A	N/A	N/A	N/A
C	48.3	1227	48.3	1227	48.3	1227	N/A	N/A	N/A	N/A	N/A	N/A	N/A	N/A	N/A	N/A	N/A	N/A	N/A
D	124.3	3158	124.3	3158	124.3	3158	N/A	N/A	N/A	N/A	N/A	N/A	N/A	N/A	N/A	N/A	N/A	N/A	N/A
E	-	-	-	-	-	-	N/A	N/A	N/A	N/A	N/A	N/A	N/A	N/A	N/A	N/A	N/A	N/A	N/A
Z	20.4	519	20.4	519	20.4	519	N/A	N/A	N/A	N/A	N/A	N/A	N/A	N/A	N/A	N/A	N/A	N/A	N/A
F	55.1	1400	55.1	1400	55.1	1400	N/A	N/A	N/A	N/A	N/A	N/A	N/A	N/A	N/A	N/A	N/A	N/A	N/A
G	59.1	1500	59.1	1500	59.1	1500	N/A	N/A	N/A	N/A	N/A	N/A	N/A	N/A	N/A	N/A	N/A	N/A	N/A
H	55.1	1400	55.1	1400	55.1	1400	N/A	N/A	N/A	N/A	N/A	N/A	N/A	N/A	N/A	N/A	N/A	N/A	N/A
I	40.6	1030	40.6	1030	40.6	1030	N/A	N/A	N/A	N/A	N/A	N/A	N/A	N/A	N/A	N/A	N/A	N/A	N/A
J	38.6	981	38.6	981	38.6	981	N/A	N/A	N/A	N/A	N/A	N/A	N/A	N/A	N/A	N/A	N/A	N/A	N/A
K	45.9	1167	45.9	1167	45.9	1167	N/A	N/A	N/A	N/A	N/A	N/A	N/A	N/A	N/A	N/A	N/A	N/A	N/A
L	64.3	1633	64.3	1633	64.3	1633	N/A	N/A	N/A	N/A	N/A	N/A	N/A	N/A	N/A	N/A	N/A	N/A	N/A

Note: Water side reversing valve option is only available for 80, 100, 120 TON ACX units.

Units with Pump Package Option

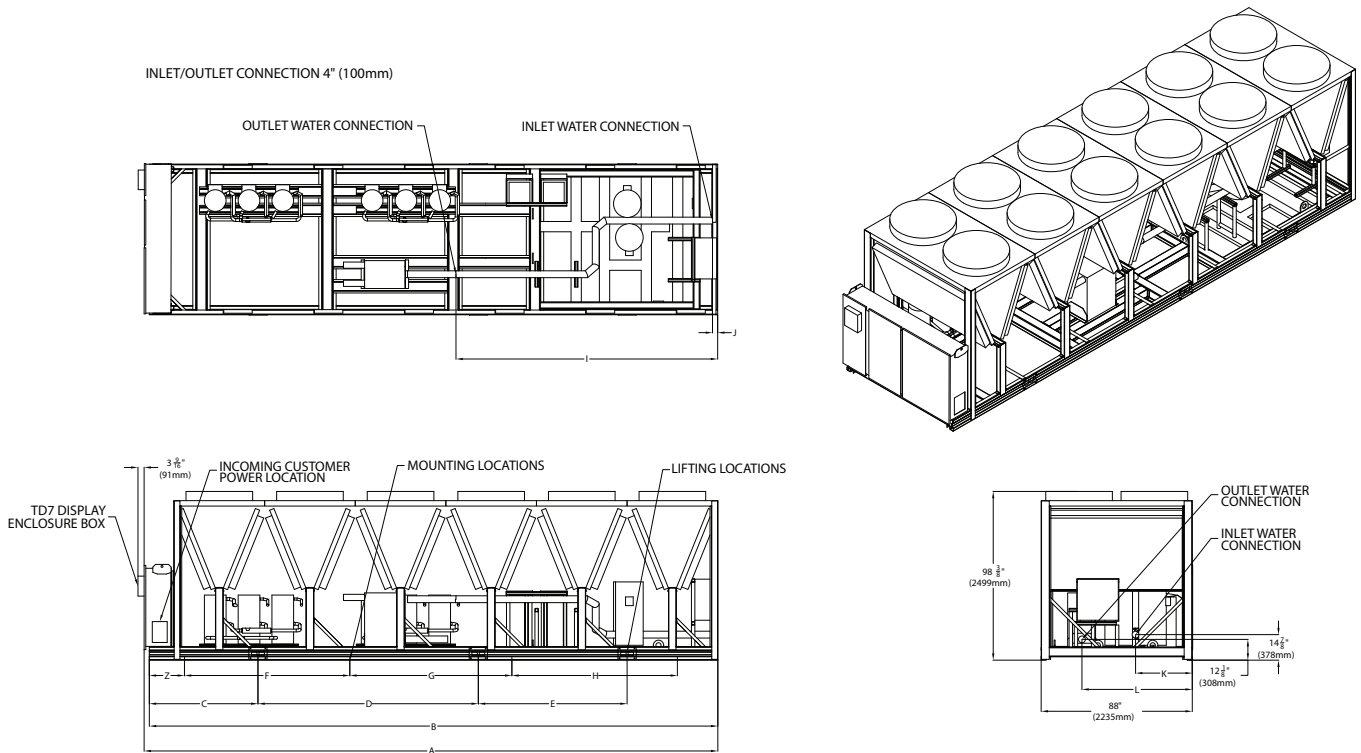

Dim	Unit Size																	
	80		100		120		140		160		180		200		215		230	
	in	mm	in	mm	in	mm	in	mm	in	mm	in	mm	in	mm	in	mm	in	mm
A	228.8	5810	228.8	5810	228.8	5810	228.8	5810	228.8	5810	281.6	7153	281.6	7153	334.4	8494	334.4	8494
B	225.8	5734	225.8	5734	225.8	5734	225.8	5734	225.8	5734	278.6	7075	278.6	7075	331.4	8418	331.4	8418
C	48.3	1227	48.3	1227	48.3	1227	48.3	1227	48.3	1227	63.3	1608	63.3	1608	63.3	1608	63.3	1608
D	124.3	3158	124.3	3158	124.3	3158	124.3	3158	124.3	3158	162.1	4116	162.1	4116	128.5	3264	128.5	3264
E	-	-	-	-	-	-	-	-	-	-	-	-	-	-	86.8	2203	86.8	2203
Z	20.4	519	20.4	519	20.4	519	20.4	519	20.4	519	40.1	1019	40.1	1019	40.1	1019	40.1	1019
F	55.1	1400	55.1	1400	55.1	1400	55.1	1400	55.1	1400	76.8	1949	76.8	1949	76.8	1949	76.8	1949
G	59.1	1500	59.1	1500	59.1	1500	59.1	1500	59.1	1500	59.1	1500	59.1	1500	94.5	2400	94.5	2400
H	55.1	1400	55.1	1400	55.1	1400	55.1	1400	55.1	1400	70.9	1800	70.9	1800	96.4	2450	96.4	2450
I	10.6	268	10.6	268	10.6	268	10.6	268	39.6	1006	39.6	1006	100.1	2542	152.9	3883	152.9	3883
J	2.9	73	2.9	73	2.9	73	5.3	134	5.3	134	3.2	81	3.2	81	3.2	81	3.2	81
K	32.6	829	32.6	829	32.6	829	32.8	832	32.8	832	33.0	838	33.0	838	33.0	838	33.0	838
L	75.4	1915	75.4	1915	75.4	1915	75.4	1915	75.4	1915	64.3	1632	64.3	1632	64.3	1633	64.3	1633



Dimensions and Weights

Units with Partial Heat Recovery Option

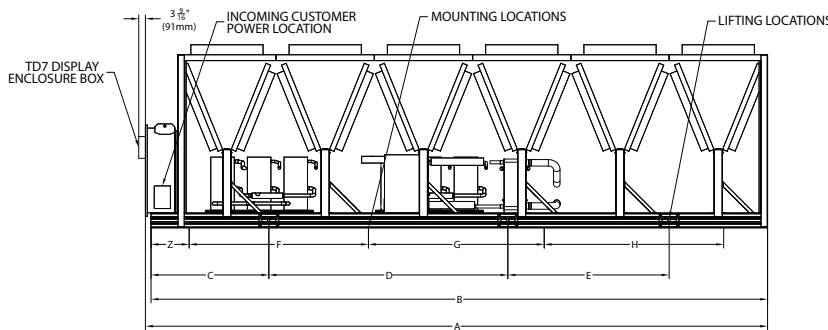
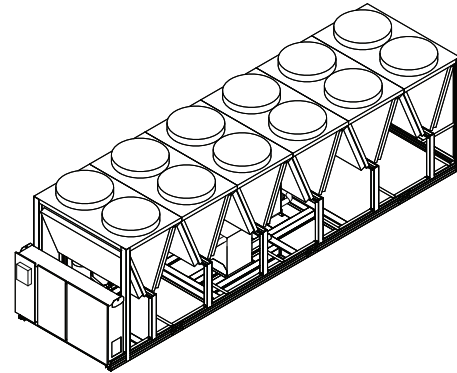
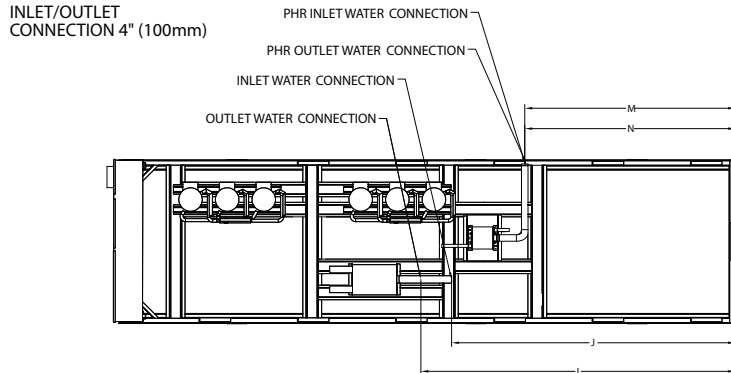

PHR INLET/OUTLET CONNECTION 2.5\"/>

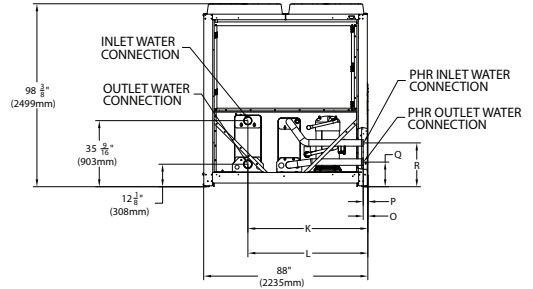

Dim	Unit Size											
	140		160		180		200		215		230	
	in	mm	in	mm	in	mm	in	mm	in	mm	in	mm
A	228.8	5810	228.8	5810	281.6	7153	281.6	7153	334.4	8494	334.4	8494
B	225.8	5734	225.8	5734	278.6	7075	278.6	7075	331.4	8418	331.4	8418
C	48.3	1227	48.3	1227	63.3	1608	63.3	1608	63.3	1608	63.3	1608
D	124.3	3158	124.3	3158	162.1	4116	162.1	4116	128.5	3264	128.5	3264
E	-	-	-	-	-	-	-	-	86.8	2203	86.8	2203
Z	20.4	519	20.4	519	40.1	10189	40.1	10189	40.1	1019	40.1	1019
F	55.1	1400	55.1	1400	76.8	1949	76.8	1949	76.8	1949	76.8	1949
G	59.1	1500	59.1	1500	59.1	1500	59.1	1500	94.5	2400	94.5	2400
H	55.1	1400	55.1	1400	70.9	1800	70.9	1800	96.4	2450	96.4	2450
I	68.8	1626	68.8	1626	104.6	2656	104.6	2656	157.4	3997	157.4	3997
J	64.0	1471	64.0	1471	99.8	2534	99.8	2534	152.6	3875	152.6	3875
K	64.3	1633	64.3	1633	64.3	1633	64.3	1633	64.3	1633	64.3	1633
L	64.3	1633	64.3	1633	64.3	1633	64.3	1633	64.3	1633	64.3	1633
M	45.5	1156	45.5	1156	60.4	1535	60.4	1537	113.3	2877	113.3	2877
N	45.5	1156	45.5	1156	60.4	1535	60.4	1537	113.3	2877	113.3	2877
O	2.1	54	2.1	54	2.1	54	2.1	57	2.1	54	2.1	54
P	2.1	54	2.1	54	2.1	54	2.1	57	2.1	54	2.1	54
Q	13.0	329	13.0	329	13.3	337	13.3	337	13.3	337	13.3	337
R	23.3	591	23.3	591	23.6	599	23.6	599	23.6	599	23.6	599

Service Clearance

Figure 4. Unit service clearance requirements

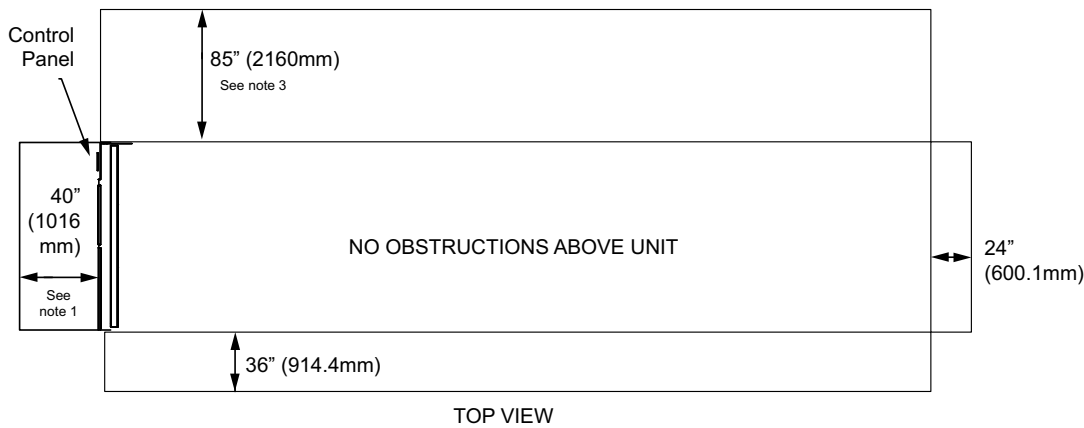

Notes:

1. A full 40" clearance is required in front of the control panel. Must be measured from front of panel, not end of unit base. Installer must also follow NEC and local/state codes for electrical clearance requirements.
2. Area above unit is required for operation, maintenance, access panel and air flow. No obstructions above unit.
3. Clearance of 85" on the side of the unit is required for coil replacement. Preferred side for coil replacement is shown (left side of the unit, as facing control panel), however either side is acceptable.
4. For obstructions or multiple units, refer to Close-Spacing and Restricted Airflow Situations Engineering Bulletin (AC-PRB001*-EN).



Dimensions and Weights

Weights

Table 8. Unit weights

Unit Size (tons)		Standard Unit				Options - Additional Weight							
		Shipping		Operating		Pump Package		Water Reversing Valve Only		Water Reversing Valve and Pump		PHR	
		lb	kg	lb	kg	lb	kg	lb	kg	lb	kg	lb	kg
ACS	140	7754	3517	7897	3581	2970	1347	N/A	N/A	N/A	N/A	518	235
	160	7754	3517	7897	3581	2970	1347	N/A	N/A	N/A	N/A	518	235
	180	9434	4278	9577	4343	3205	1454	N/A	N/A	N/A	N/A	626	284
	200	9434	4278	9577	4343	3205	1454	N/A	N/A	N/A	N/A	626	284
	215	10376	4706	10520	4771	3711	1683	N/A	N/A	N/A	N/A	525	238
	230	10523	4772	10701	4853	3711	1683	N/A	N/A	N/A	N/A	524	238
ACX	80	8051	3652	8139	3692	3318	1505	662	300	3634	1645	N/A	N/A
	100	9137	4145	9254	4198	2970	1347	316	143	3286	1487	N/A	N/A
	120	9516	4223	9633	4276	2970	1347	316	143	3286	1487	N/A	N/A
	140	9667	4389	9809	4453	2970	1347	N/A	N/A	N/A	N/A	N/A	N/A
	160	9667	4389	9809	4453	2970	1347	N/A	N/A	N/A	N/A	N/A	N/A
	180	11735	5328	11877	5392	3205	1454	N/A	N/A	N/A	N/A	N/A	N/A
	200	11735	5328	11877	5392	3205	1454	N/A	N/A	N/A	N/A	N/A	N/A
	215	13020	5911	13162	5976	3711	1683	N/A	N/A	N/A	N/A	N/A	N/A
230	13135	5963	13311	6043	3711	1683	N/A	N/A	N/A	N/A	N/A	N/A	

Note: Weights include factory charge of refrigerant and oil.



Mechanical Specifications

General

Units are leak tested, pressure tested, then evacuated and charged. All chillers are factory tested prior to shipment. Units ship with a full operating charge of oil and refrigerant as standard. Units can also be shipped with a nitrogen charge if required. Unit panels, structural elements and control boxes are constructed of galvanized steel and mounted on a bolted galvanized steel base. Unit panels, control boxes and the structural base are finished with a baked on powder paint.

Certified AHRI Performance

Trane air-cooled chillers are rated within the scope of the Air-Conditioning, Heating and Refrigeration Institute (AHRI) Certification Program and display the AHRI Certified® mark as a visual confirmation of conformance to the certification sections of AHRI Standard 550/590 (I-P) and ANSI/AHRI Standard 551/591 (SI). The applications in this catalog specifically excluded from the AHRI certification program are:

- Custom Units.
- Units produced outside of the USA for installations outside the USA.
- Evaporatively-cooled chillers.
- Units with evaporators that use fluid other than fresh water except units containing freeze protection fluids in the evaporator with a leaving chilled fluid temperature above 32°F [0°C] are certified when rated per the Standard with water.

Refrigeration Circuits

All chiller sizes are designed with two refrigerant circuits.

Each refrigeration circuit includes two or three scroll compressors, a compressor suction and discharge service valve, liquid line shutoff valve, removable core filter, liquid line sight glass with moisture indicator, charging port and an electronic expansion valve. Additionally, there is an auxiliary line shutoff valve for ACX 080–120 tons.

Evaporator

Braze plate heat exchanger is made of stainless steel with copper as the braze material. It is designed to withstand a refrigerant side working pressure of 650 psig and a waterside working pressure of 150 psig. Evaporator is tested at 1.1 times maximum allowable refrigerant side working pressure and 1.5 times maximum allowable water side working pressure.

Immersion heaters protect the evaporator to an ambient of -20°F (-29°C). The evaporator is covered with factory-installed 0.75 inch (19.05 mm) Armaflex II or equal (k=0.28) insulation. Foam insulation is used on the suction line.

Condenser and Fans

For ACSA units, the air-cooled microchannel condenser coils are used with all aluminum brazed fin construction. For ACXA units, the round tube plate fin (RTPF) coils are used with aluminum fin constructions. The condenser coil has an integral subcooling circuit. The maximum allowable working pressure of the condenser is 650 psig. Condensers are factory proof and leak tested at 1.1 times maximum allowable refrigerant side working pressure. Coils can be cleaned with high pressure water.

Direct-drive vertical-discharge airfoil condenser fans are dynamically balanced. The condenser fan motors are permanent magnet motors with integrated drive to provide variable speed fan control for all fans.

Chillers are equipped with EC or AC condenser fan motors with permanently lubricated ball bearings and internal thermal and overload protection.



Mechanical Specifications

Compressor

The unit is equipped with two or more hermetic, direct-drive, 3600 rpm 60 Hz suction gas-cooled scroll compressors with intermediate discharge valve to increase seasonal efficiency. Overload protection is included. The compressor includes: centrifugal oil pump, oil level sight glass and oil charging valve. Each compressor will have compressor heaters installed and properly sized to minimize the amount of liquid refrigerant present in the oil sump during off cycles. Moreover, there is an injection port in the compressor of ACX 080–120 tons to both enlarge the application envelope and improve efficiency.

Unit Controls

All unit controls are housed in an outdoor rated weather tight enclosure with removable plates to allow connection of power wiring and remote interlocks. All controls, including sensors, are factory mounted and tested prior to shipment.

Microcomputer controls provide all control functions including start-up and shutdown, leaving chilled water temperature control, evaporator flow proving, compressor staging and speed control, electronic expansion valve modulation, condenser fan sequencing and speed control, anti-recycle logic, automatic lead/lag compressor starting, and load limiting.

Symbio™ 800 Controller

The Symbio 800 controller is an application-specific, programmable controller that is factory installed and designed to control packaged HVAC equipment. A 7-inch user interface features a touch-sensitive color screen that provides facility managers with at-a-glance operating status, performance monitoring, scheduling changes and operating adjustments. Other advanced features include automated controller backup and optional features such as secure remote connectivity, wireless building communications, and custom programming with expandable I/O.

The Symbio 800 control module, utilizing Adaptive Control™ microprocessor, automatically takes action to avoid unit shutdown due to abnormal operating conditions associated with low refrigerant pressure, high condensing pressure, AFD/Compressor current overload, low oil return or low AFD cooling, low discharge superheat, and high compressor discharge temperature. Should the abnormal operating condition continue until a protective limit is violated, the unit will be shutdown.

Unit protective functions of the controller include: loss of chilled water flow, evaporator freezing, loss of refrigerant, low refrigerant pressure, high refrigerant pressure, high compressor motor temperature, and loss of oil to the compressor.

BACnet® Communication Protocol

The Symbio 800 controller supports standard BACnet communication protocol through a RS485, two-wire communication link or BACnet/IP over Ethernet.

Trane LonTalk® Communication Protocol

The LonTalk module provides an interface to a Tracer® building automation system or other control system that supports LonTalk and is factory installed, allowing for control and monitoring of the unit through a RS485, two-wire communication link. Requires an additional LonTalk Communication Kit to be installed.

Modbus® Communication Protocol

The Symbio 800 controller supports standard Modbus RTU communication protocol through an RS485, two-wire communication link.

Controls Expansion Hardware

Symbio 800 includes field applied controls capability. Factory installed expansion hardware (XM70) has 19 inputs/outputs. Additional expansions may be added in the field.

Tracer® AdaptiView™ TD-7 Display

A full color Tracer® AdaptiView™ TD-7 touch screen display indicates all important unit and circuit parameters, in logical groupings on various screens. The parameters including chilled water setpoint, leaving evaporator temperature, demand limit setpoint, evaporator and condenser refrigerant temperatures and pressures, compressor and fan speeds, and all pertinent electrical information. The

display also provides “on screen” data graphs of predefined parameters as well as customizable data graphs based on user defined parameters from a list of all available parameters. The display also provides indication of the chiller and circuits’ top level operating modes with detailed sub-mode reports available with a single key press, as well as diagnostics annunciation and date and time stamped diagnostic history. The color display is fully outdoor rated, and can be viewed in full daylight without opening any control panel doors.

Standard power connections include main three phase power to the compressors, condenser fans and control power transformer and optional connections are available for the 115 volt/60 Hz single phase power for the thermostatically controlled evaporator heaters for freeze protection.

- Outdoor capable:
 - UV Resistant Touchscreen
 - Operating Temperature: -40°C to 70°C
 - IP56 rated (Power Jets of Water from all directions)
- RoHS Compliant
- UL PAZX, Open Energy Management Equipment
- CE Certification
- Emissions: EN55011 (Class B)
- Immunity: EN61000 (Industrial)
- Display:
 - 7-inch diagonal
 - 800x480 pixels.
 - TFT LCD @ 600 nits brightness
 - 16 bit color graphic display
- Display Features:
 - Alarms
 - Reports
 - Unit Settings
 - Display Settings
- Graphing
- Global Application with Support for 27 Languages

Chilled Water Reset

Control logic and factory installed sensors are provided to reset leaving chilled water temperature. The set point can be reset based on ambient temperature or return evaporator water temperature.

Factory Mounted Flow Proving and Flow Control

The factory installed evaporator water flow switch is provided with the control logic and relays to turn the chilled water flow on and off as the chiller requires for operation and protection. This function is a requirement on the chiller.



Options

Application Options

Ice Building

The ice building option provides special control logic to handle low temperature brine applications (less than 40°F [4.4°C] leaving evaporator temperature) for thermal storage applications.

Low Temperature Fluid

Low temperature option provides special control logic to handle low temperature brine applications including part load conditions below 40°F (4.4°C) leaving evaporator temperature.

Low Ambient Option

The low ambient options adds hardware and unit controls to allow start and operation down to ambient temperatures of -20°F (-29°C).

High Ambient Option

High ambient option permits high ambient (up to 125°F [51.7°C]) operation. Low side ambient remains 32°F (0°C).

Wide Ambient Option

The wide ambient option combines the features of low and high ambient options for an ambient range of -20 to 125°F (-29 to 51.7°C).

Pump Package

The pump package contains a single pump or dual pumps (one redundant), drain valves, service isolation valves, pressure ports, pressure relief, and fluid strainer.

Pump package applications include short water loops, decoupled systems and service for an entire loop volume. Because the fluid distribution system beyond the chiller is unknown, Trane Select Assist reports Available Head as the head leaving the brazed plate evaporator. Head leaving the evaporator includes the evaporator head loss, pump package piping frictional effects head losses, valve head losses, and strainer head loss summation.

The pump package should not be operated at NPSHR. Operation at this suction head will cause cavitation. NPSHA should be at least 1.5 to 2.5 times NPSHR.

Ambient freeze protection for water down to the following temperatures (depending on the freeze inhibitor solution, the freeze protection ambient temperature decreases accordingly).

- **ACX 80, 100, 120 tons:** -15°F (-26° C)
- **ACS/ACX 140 to 230 tons:** -4°F (-20° C)

The pump skid contains an independent pump motor starter panel. The pump starter panel's power supply is prewired into the chiller's control panel assembly, an independent pump motor power supply is not required. Variable pump speed command is integrated with the chiller controller allowing variable flow functionality.

Partial Heat Recovery

Instead of exhausting it to the atmosphere, the heat recovery option re-uses the waste heat generated during the cooling cycle, allowing the unit to operate as a standard chiller when heat is not required. It can simultaneously produce chilled and hot water, which can be used for applications such as:

- Heating or preheating of boiler systems or domestic cater
- Air conditioning/ventilation air preheating
- Industrial processes

Note: The heat recovery exchanger is not suited for food and beverage applications, where a primary loop is mandatory. The brazed plate heat recovery exchanger is connected to the compressor discharge line, mounted in series to the air-cooled condenser, and sized to recover up to 60% of the nominal cooling capacity. Inlet and outlet water sensors and two two-way valve are included. Symbio™ 800 controls the two-way valves and condenser fans to maximize heat recovery capacity. Inlet, outlet water temperatures and the thermal switch can be viewed on the Tracer AdaptiView™ TD7 and Tracer® TU.

The amount of net heat recovery depends on:

- Percentage of cooling load available
- Ambient temperature
- Inlet water temperature

Water Reversing Valve Assembly (Option)

The water reversing valve assembly incorporates two 3-way valves with two actuators and associated pipings. This option can provide a much higher heating efficiency. The actuators have integrated linkage and provides 90° rotation with a visual indicator. The valves are controlled by Symbio™ controller.

Electrical Options

Circuit Breaker

A HACR rated molded case capacity circuit breaker (UL approved) is available. Circuit breaker can also be used to disconnect chiller from main power with a through-the-door handle.

Energy Meter

Energy meter capable of measuring line current by phase, average current, voltage by phase, average voltage, frequency, unit power consumption, reactive and apparent power, and power factor.

Control Options

Wireless Connectivity Options

- WiFi® module is a wireless interface option to service technician to connect the chiller to the service tool interface.
- LTE modem is a wireless interface option to allow the chiller to pass performance and diagnostic information to Trane Intelligent Services without the need for an internal network.
- Air-Fi® module is a wireless interface option to connect the chiller to a Trane Tracer® system.

BACnet® Communications Interface

Allows the user to easily interface with BACnet via a single twisted pair or Ethernet wiring to a factory-installed Symbio™ 800 controller.

LonTalk® Communications Interface

Provides the LONMARK® chiller profile inputs/outputs for use with a generic building automation system via a single twisted pair wiring to a factory-installed Symbio™ 800 controller.

Modbus® Communications Interface

Allows the user to easily interface with Modbus® via a single twisted pair wiring to a factory-installed Symbio™ 800 controller.

Remote Input Options

Option permits remote chilled liquid setpoint, remote demand limit setpoint, or both by accepting a 4-20 mA or 2-10 Vdc analog signal.



Options

Remote Output Options

Permits alarm relay outputs, chiller Percent Capacity via a 2–10VDC signal, or both.

Tracer Communication Interface

Interface permits bi-directional communication to Tracer® SC or ES system via BACnet® interface.

Sound Options

Acoustic Package

Each compressor includes a factory installed acoustical treatment.

Other Options

Architectural Louvered Panels

Louvered panels cover the entire condensing coil and service area beneath the condenser.

Condenser Corrosion Protection

CompleteCoat™ is available on all size units for corrosion protection. Job site conditions should be considered to determine the need to order coating to inhibit coil corrosion and ensure extended equipment life. CompleteCoat™ option provides fully assembled coils with a flexible dip and bake epoxy coating.

Convenience Outlet

Provides a 20 amp, 115V (60 Hz) convenience outlet on the unit.

Insulation for High Humidity

The evaporator is covered with factory-installed 1.25 inch (31.8 mm) Armaflex II or equal (k=0.28) insulation.

Isolators — Elastomeric

Elastomeric Isolators provide isolation between chiller and structure to help eliminate vibration transmission.

Drain Pan

Drain pan option is available on ACXA units. The drain pan is used to collect the defrost water during heating mode and convey to customer plumbing system. Drain pan can be removed for on site cleaning and re-installed.



The AHRI Certified mark indicates Trane U.S. Inc. participation in the AHRI Certification program. For verification of individual certified products, go to ahridirectory.org.

Trane - by Trane Technologies (NYSE: TT), a global innovator - creates comfortable, energy efficient indoor environments for commercial and residential applications. For more information, please visit trane.com or tranetechnologies.com.

Trane has a policy of continuous product and product data improvements and reserves the right to change design and specifications without notice. We are committed to using environmentally conscious print practices.