

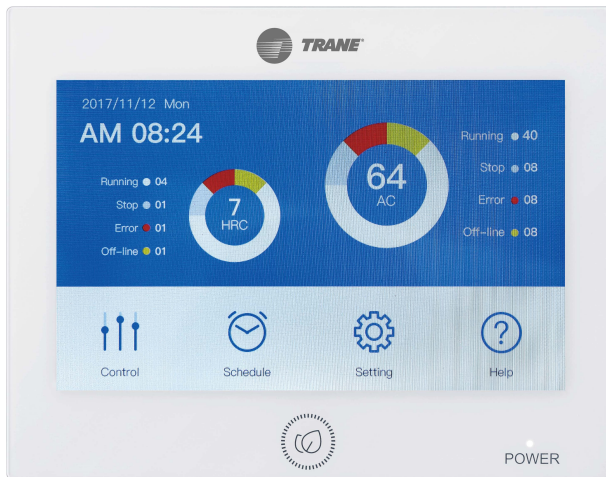

TCONTCCMSA164 CENTRALIZED Controller U-Match Inverter Systems / Multi Split Inverter Systems



SAFETY WARNING

Only qualified personnel should install and service the equipment. The installation, starting up, and servicing of heating, ventilating, and air-conditioning equipment can be hazardous and requires specific knowledge and training. Improperly installed, adjusted or altered equipment by an unqualified person could result in death or serious injury. When working on the equipment, observe all precautions in the literature and on the tags, stickers, and labels that are attached to the equipment.

August 2021

MS-SVX083A-EN

TRANE
TECHNOLOGIES

Confidential and proprietary Trane information

Function introduction of central controller

Product effect diagram

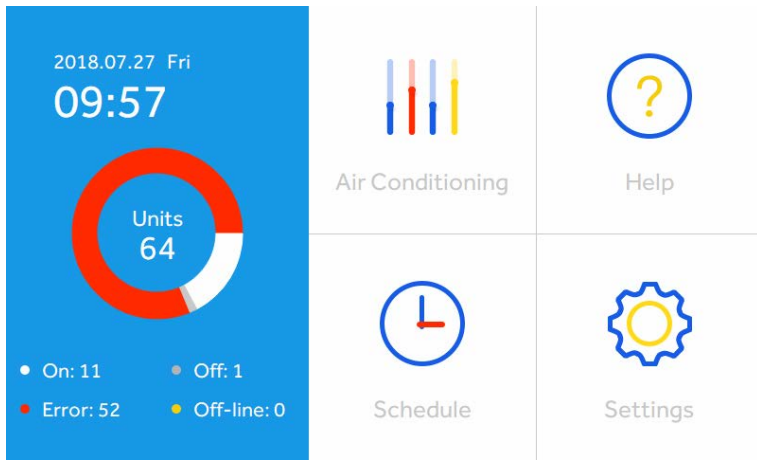

Function overview
Picture 1

This central controller can control U-Match and Multi split. A maximum of 64 indoor units of any combination can be controlled to a single central controller. The TCONTCCMSA164 can automatically recognize the model as a U-Match or Multi split, no need to manually set up.

- ① Each indoor unit requires one TCONTADPYCJA2A adapter.
- ② Receiving outer signal input: when receiving outer fire alarm signal, central controller will turn all indoor units off. PS: if no outer signal input, should short circuit the ALARM1 and ALARM2.
- ③ Weekly timer setting. Weekly timer for one or some or all units can be set and can run in cycle, or set Except Date and ONCE. the “except date” can be set under “WEEK” of the schedule , and the “once date” can be set at the “ONCE” of the schedule.
- ④ ECO (sets maximum and minimum allowable temperature set points) Cool Only/ Heat Only and DST can be set based on actual requirement.

Part info for central controller

ON/OFF button:

Power on:press the button for 2 to 3 seconds to turn on the central controller.
Press the button for 10 seconds to turn off the central controller.



Display/Touch area:

Screensaver key:

Press to turn off screen light and press again to turn on.

Power light:

Power light will be on after the central controller on.

Reset key:

Press to reboot the central controller.

Part info for central controller

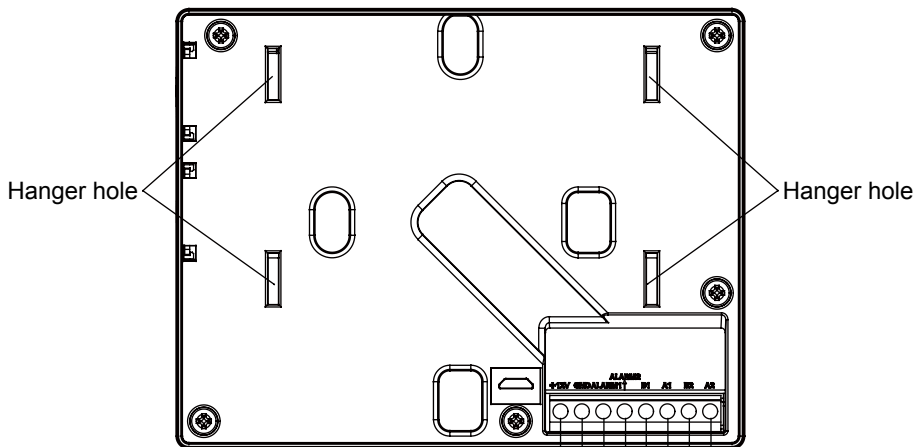

Power: 12V DC, there is +/- for power _____

AC works normally when closed and
all AC turned off when open circuit. _____

Third party interface _____

Communication port for connecting converter. _____

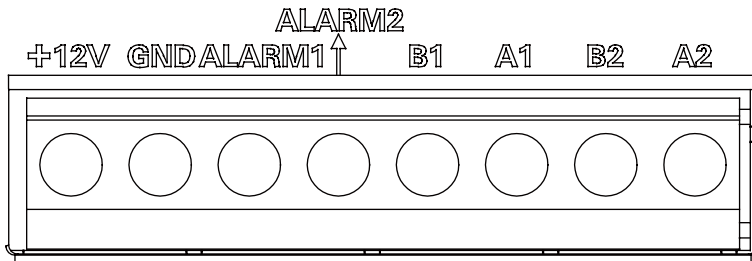

Power (12V, GND): 12V DC, please pay attention to +-of power.

Fire alarm linkage contact (ALARM1, ALARM2): AC works normally when closed and all AC turned off when open circuit. If no fire alarm linkage needed, should short circuit the ALARM1 and ALARM2.

Third party interface (B1, A1): A1 should be connected to 485+ while B1 485-.

Communication port (B2, A2): It is used for connecting converter, please pay attention to +-. A2 should be connected to 485+ while B2 485-.

Part info for central controller

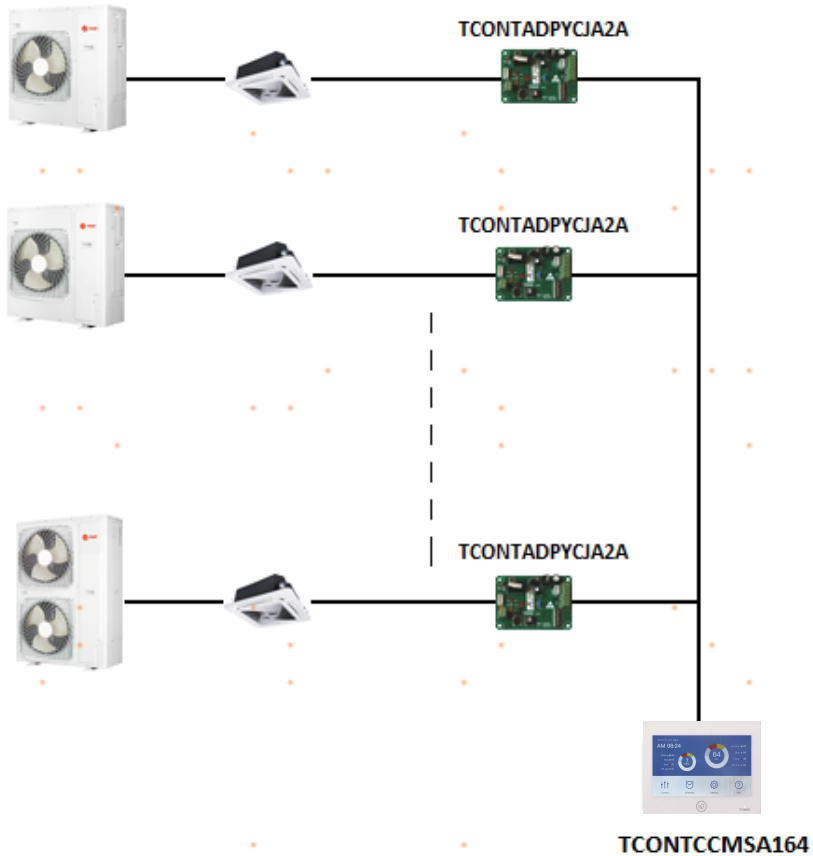

When controlling single, one indoor unit need to connected to one TCONTADPYCJA2A, and can connect maximum 64 TCONTADPYCJA2A, means can connect maximum 64 indoor units.

Function operation

Initialization

Press the on-off key on the upper right for 5 seconds to turn on the controller after powering on; then start to search for indoor units as picture 2 below:

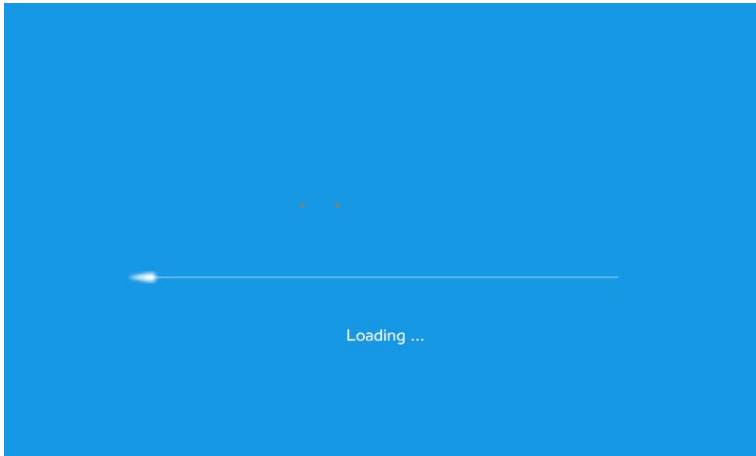

Picture 2

Home Page

When search is completed, the home page will show as below; the left side shows the Qty. of indoor units connected and the Qty. of units in condition as On/Off/Error/Offline. PS: Picture 3 is the example.

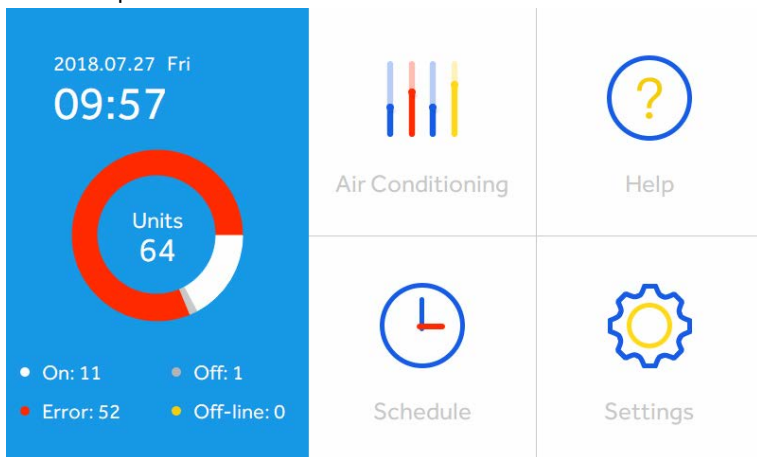

Picture 3

Function operation

Indoor units parameter and control

To see the setting for each indoor unit, tap on Air Conditioning. Shown (Picture 4) are the icons indicate the On/Off, Mode, Set Temp, Ambient Temp, Fan Speed and Control Mode of the connected indoor units.

Deep Blue is Auto Mode

Orange is Heating Mode

Green is Fan Mode

Light Blue is Cooling Mode

Purple is Dehumidify Mode

Grey is Indoor unit off

If there's any indoor fault, ERROR icon will show on the controller.

Enter the following interface, the icon type shows the internal switch, mode, setting temperature, ambient temperature, wind speed and control mode. The automatic mode is deep blue, light blue is cooling, heating is orange, dehumidification is purple, the air supply is green, and the grey is shutdown. If there is a failure, the fault icon is displayed.

Current numbers of indoor units. Default is all the existing indoor units, you can slide up and down to view. You can click on the second icon  below to select the indoor units you want to view.

Time, you can adjust the time through "Home-Setting-Time"

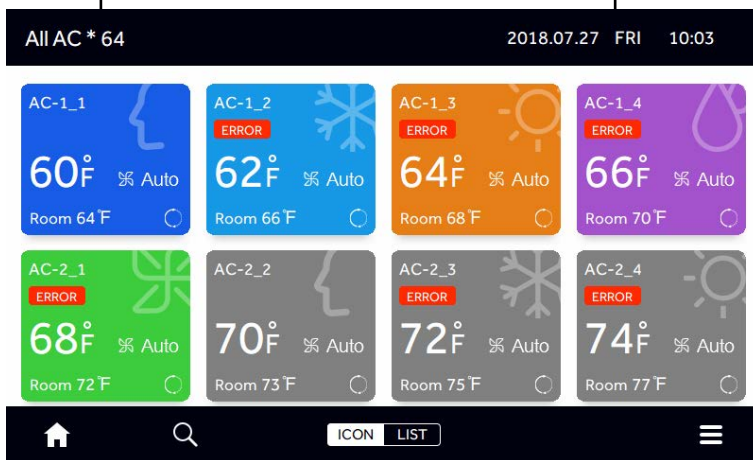

Click to return to home

Click to select the indoor units you want to view

Click to show the control list.

List display interface

Icon display interface

Function operation

Tap the top right bottom pull list , It shows the following interface:

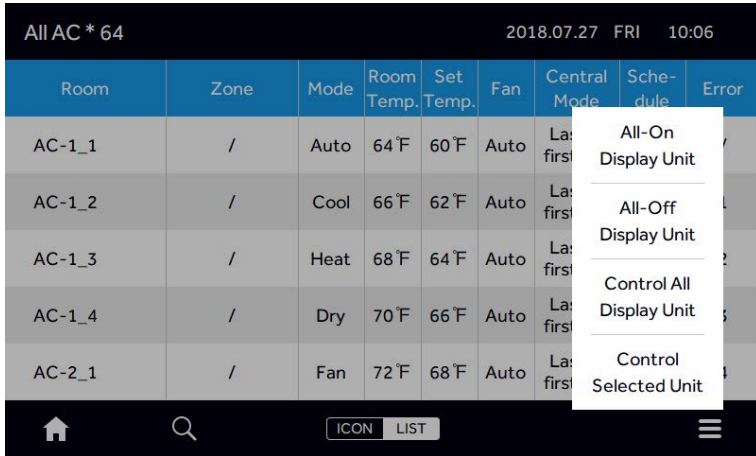

Picture 7

If tap “All-On Display Unit”, all the indoor units that are currently screened are fully opened; if tap “All-Off Display Unit”, all the currently screened indoor units close; if tap “Control All Display Unit”, the following interface is displayed:

Function operation

The number of indoor units controlled at present, by clicking the blue number can be used to select indoor units that need to be controlled.

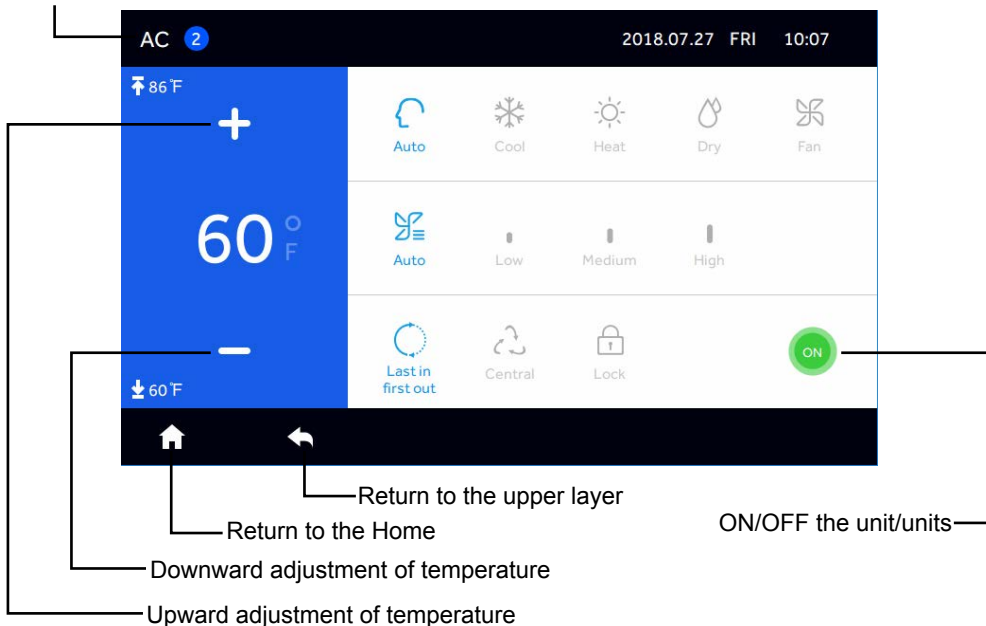

Picture 8

In the upper interface, you can control On/Off, mode, setting temperature, wind speed, control mode, control interface are as above;

note: mode, wind speed, setting temperature and control mode are not allowed to change under shutdown mode.

In the pull-up list, if you choose to select "Control Selected Unit", the display interface is as follows.

Function operation

All AC * 64		2018.07.27 FRI 10:09						
Room	Zone	Mode	Room Temp.	Set Temp.	Fan	Central Mode	Schedule	Error
<input type="radio"/> AC-1_1	/	Auto	64°F	60°F	Auto	Last in first out	No	/
<input type="radio"/> AC-1_2	/	Auto	66°F	60°F	Auto	Last in first out	No	1
<input type="radio"/> AC-1_3	/	Heat	68°F	64°F	Auto	Last in first out	No	2
<input type="radio"/> AC-1_4	/	Dry	70°F	66°F	Auto	Last in first out	No	3
<input type="radio"/> AC-2_1	/	Fan	72°F	68°F	Auto	Last in first out	No	4
Cancel							Confirm	

Picture 9

You can check the indoor unit you need to select. The interface is as follows.

All AC * 64		2018.07.27 FRI 10:09						
Room	Zone	Mode	Room Temp.	Set Temp.	Fan	Central Mode	Schedule	Error
<input checked="" type="radio"/> AC-1_1	/	Auto	64°F	60°F	Auto	Last in first out	No	/
<input checked="" type="radio"/> AC-1_2	/	Auto	66°F	60°F	Auto	Last in first out	No	1
<input type="radio"/> AC-1_3	/	Heat	68°F	64°F	Auto	Last in first out	No	2
<input checked="" type="radio"/> AC-1_4	/	Dry	70°F	66°F	Auto	Last in first out	No	3
<input type="radio"/> AC-2_1	/	Fan	72°F	68°F	Auto	Last in first out	No	4
Cancel							Confirm	

Picture 10

After click “Confirm”, the following control interface is entered :

Function operation

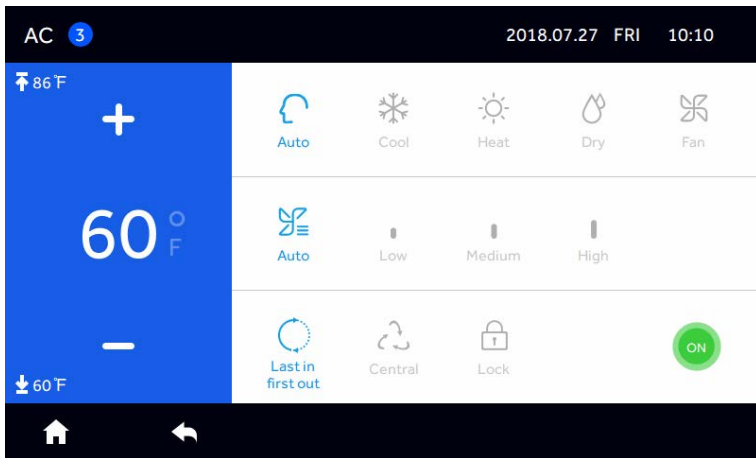

Picture 11

Last in first out:

the indoor unit will execute the last order send by central controller,wired controller or remote controller. For example, if firstly sending low fan speed order by central controller and then sending high fan speed orderby wired controller, the indoor unit will execute high fan speed.

Central:

central controller enjoys all functions while wired &remote controller can only control ON/ OFF of indoor units.

Lock:

central controller enjoys all functions while wired & remote controller cannot control indoor units.

The parameters can be adjusted according to the needs.

Click on the second icon  in the bottom row, and you can select the indoor units that need to be screened, as shown below.

Function operation

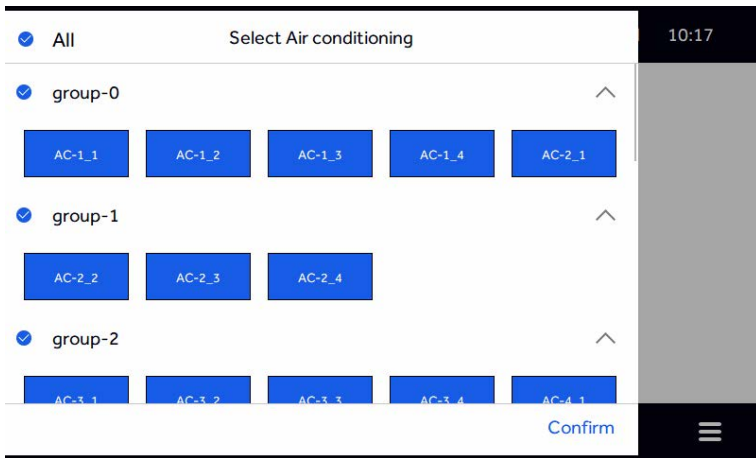

Picture 12

You can tap to select or cancel the indoor units that need to be displayed, in which blue is selected and white is not selected.

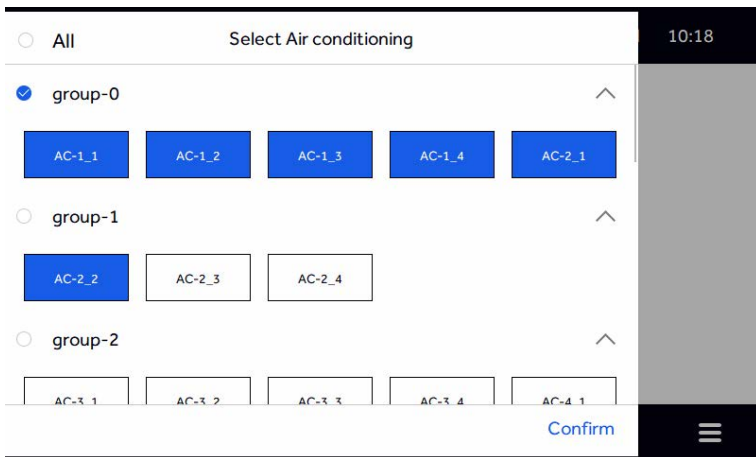

Picture 13

After selecting, click "Confirm", and as in Picture 13, the top left corner shows the number of indoor units displayed by the selected so that the user can choose the inside machine that needs to be displayed according to the needs.

Function operation

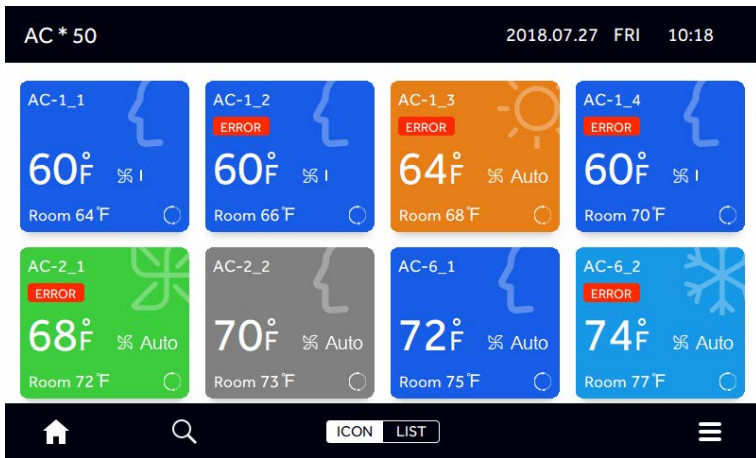

Picture 14

Help

Tap "Help" to enter the "help" interface, slide left and right, or and tap the blue icon to show the basic functionality of the product; the lower right corner shows the product model and the program version number.



Controller model _____
The software version of a controller _____

Picture 15

Function operation

The controller can control up to 64 units.

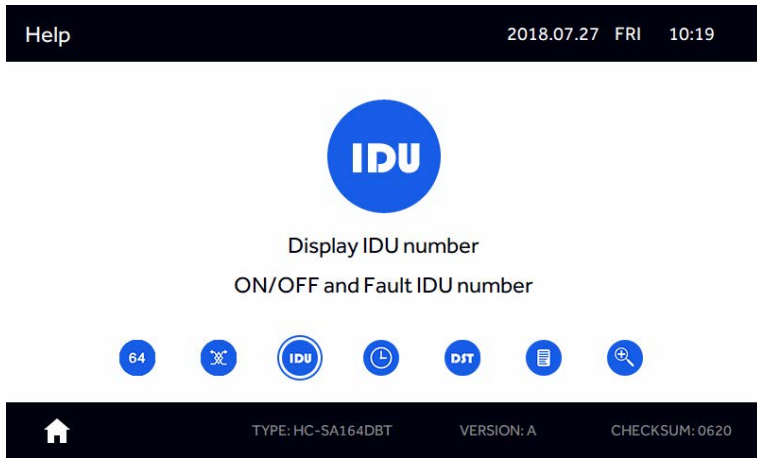

Picture 17

The controller can On/Off the indoor units and check the fault code of the indoor units.

Function operation

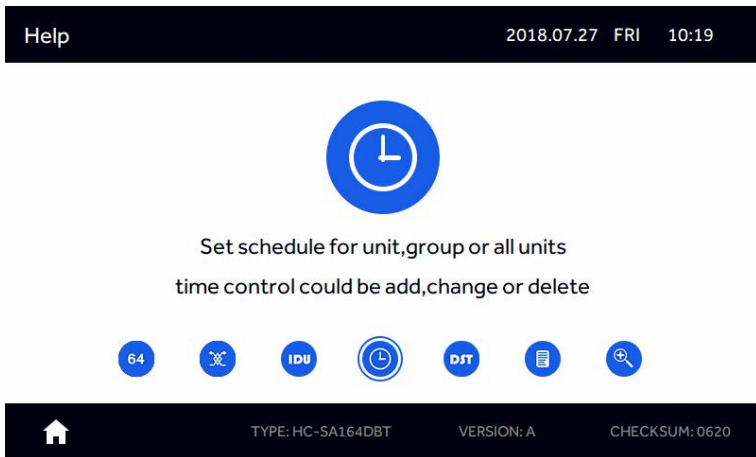

Picture 18

The central controller can add, delete and change the weekly timing control for individual units, groups of units and all units. At most 64 pieces schedules can be set.

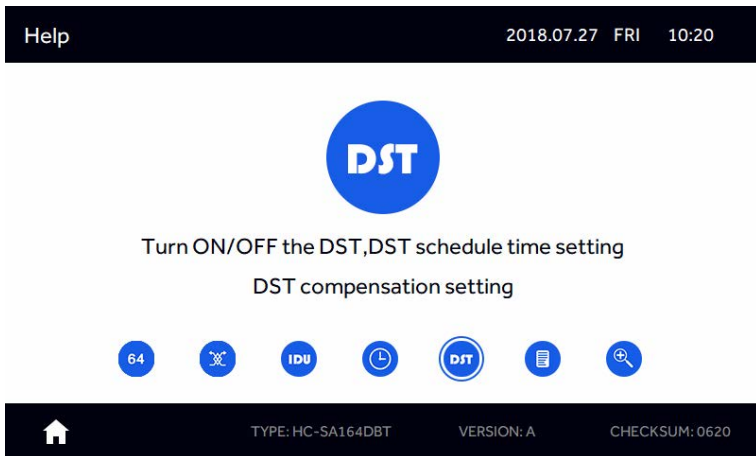

Picture 19

The user can set up and close the daylight saving time according to the needs. After the daylight saving time is opened, dates for start and end of DST can be set.

Function operation

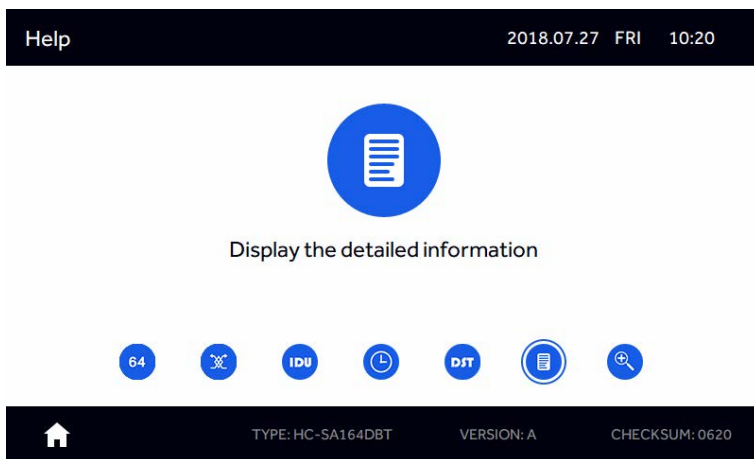

Picture 20

The collector can display the detailed information parameters of the indoor units.

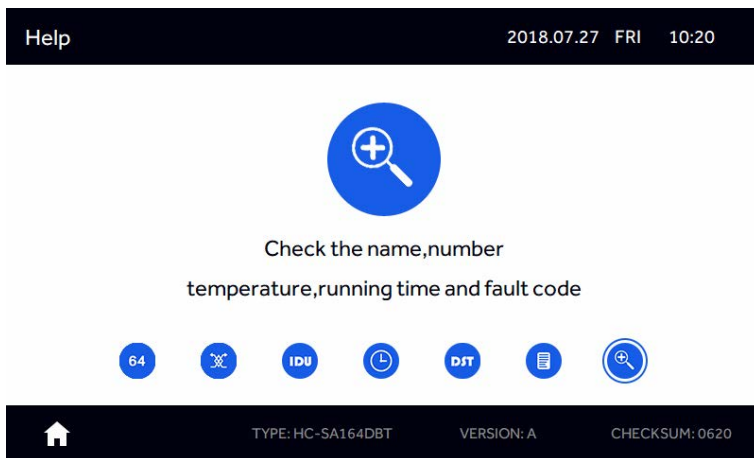

Picture 21

You can set the name of the indoor unit, you can view the fault code.

Function operation

Schedule

At most 64 schedules can be set. Tap on “Schedule” in the home interface. If schedule has been set, the set of schedule information is displayed. If you enter schedule for the first time, it will be blank like below.



Picture 22

Tap the “+” at the lower right corner to add a new schedule. Next, select the indoor units. Blue represents the indoor units are selected. Tap “All” for the whole system or select the group (See Settings to create zone groups).

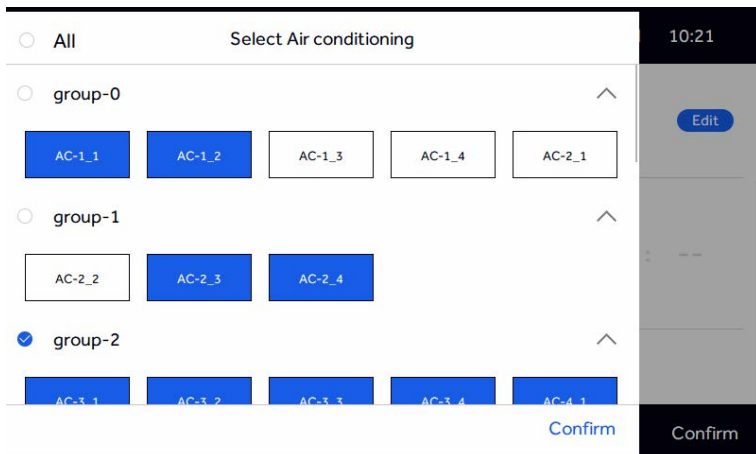

Picture 23

Function operation

When desired units or groups are selected, tap “Confirm” and enter interface as follows. You can set schedule on (start) and off (end) times, mode, temperature, control mode, Once, Cycle and Except. Tap “Edit”, to return to the indoor units selection interface.

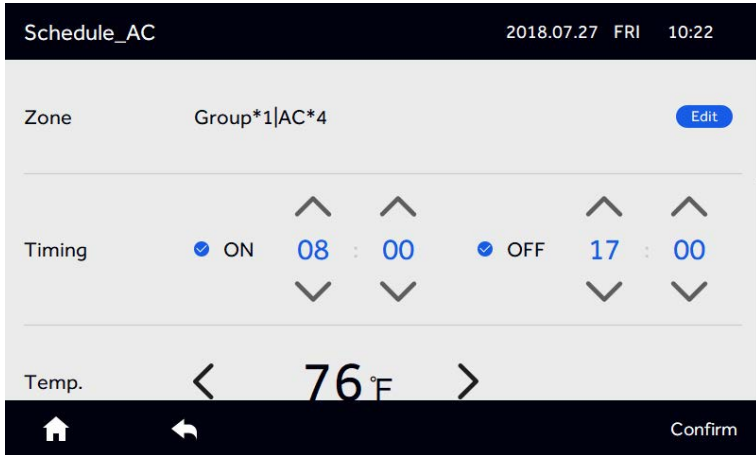

Picture 24

Tap “Confirm”, the display interface is as follows .

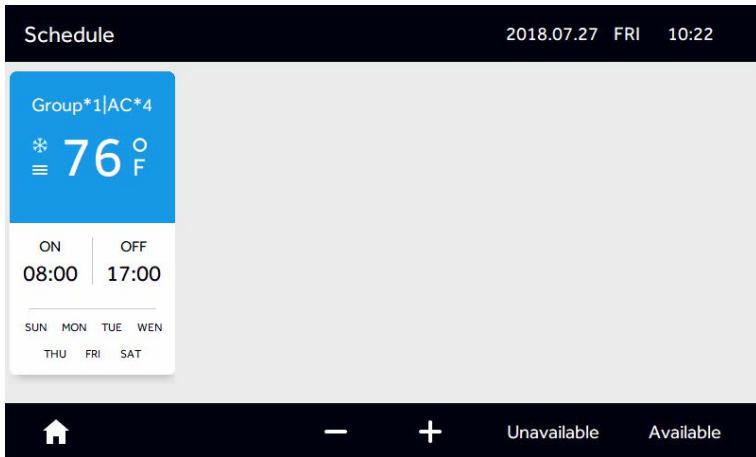

Picture 25

Repeat steps to add another schedule.

Function operation

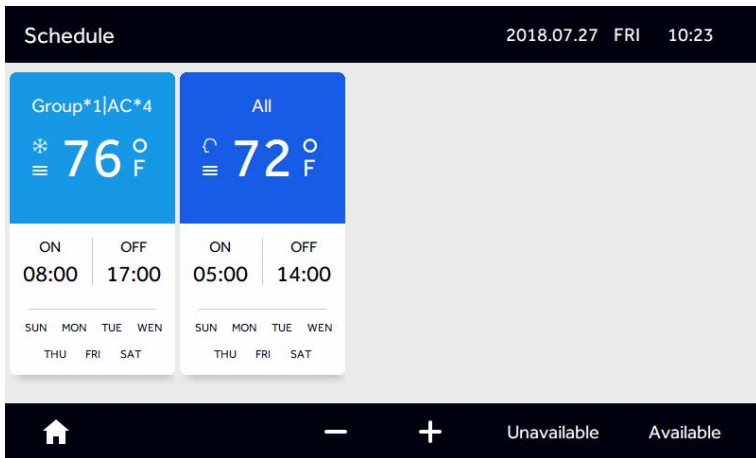

Picture 26

To delete a schedule, firstly, tap the icon '-' in the Picture 26, then small circle will appear like Picture 27, secondly, select the schedules to be deleted. Finally, press the icon 'delete' in the lower right corner

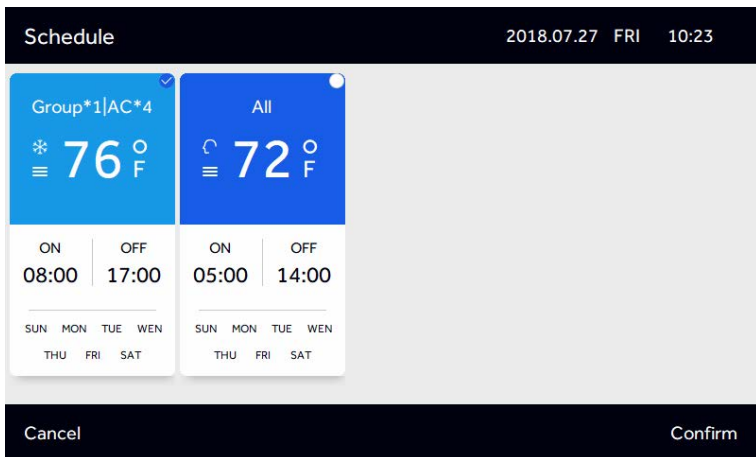

Picture 27

Function operation

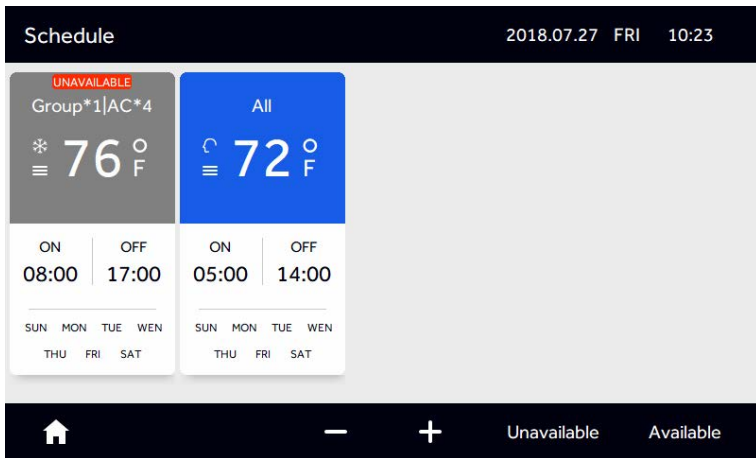

Picture 28

To make a schedule idle, tap on the “Unavailable” icon, see Picture 26. Tap the icon of the desired schedule(s) to idle. After tapping “Confirm”, it shows the schedule as “UNAVAILABLE” as seen in Picture 28.

To reactivate a schedule that is idle then tap “Available” as seen at the bottom right of Picture 29. Tap the icon of the desired schedule(s) to reactivate. Then tap “Confirm” as seen at the bottom right of Picture 29.

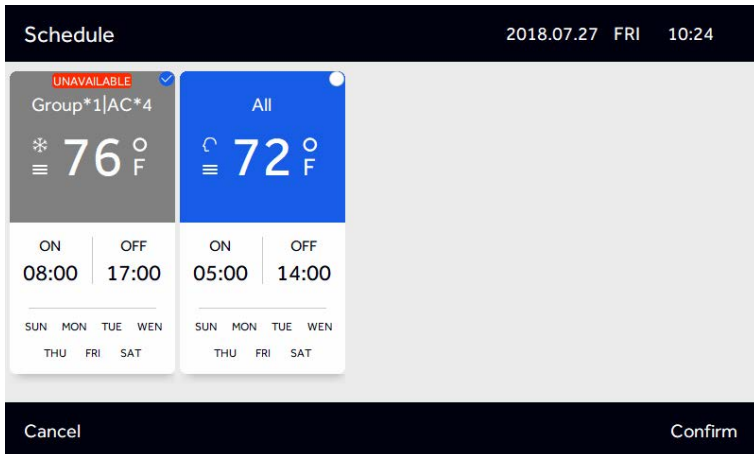

Picture 29

Function operation

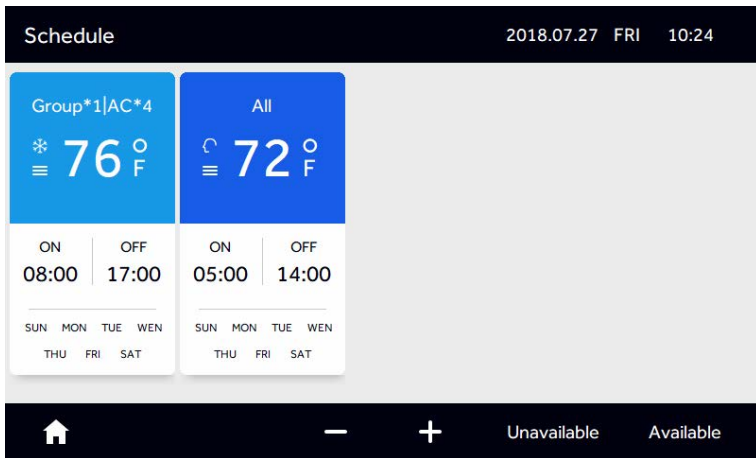

Picture 30

You can set the exception time for the schedule, click “Edit” on the bottom of the week to add and modify the “Except Date”.

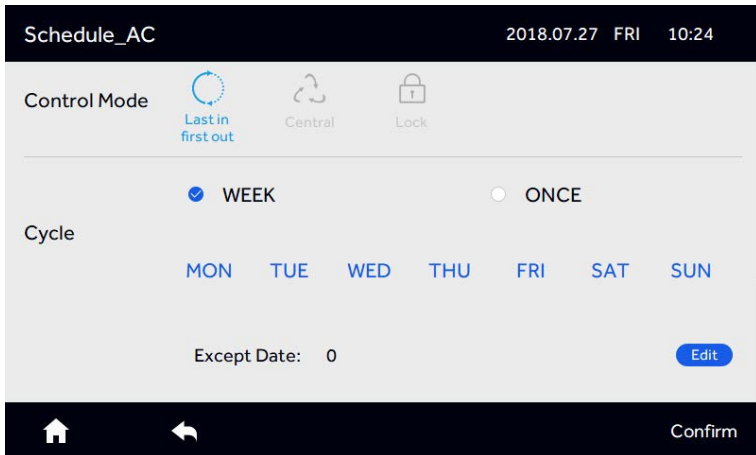

Picture 31

Function operation

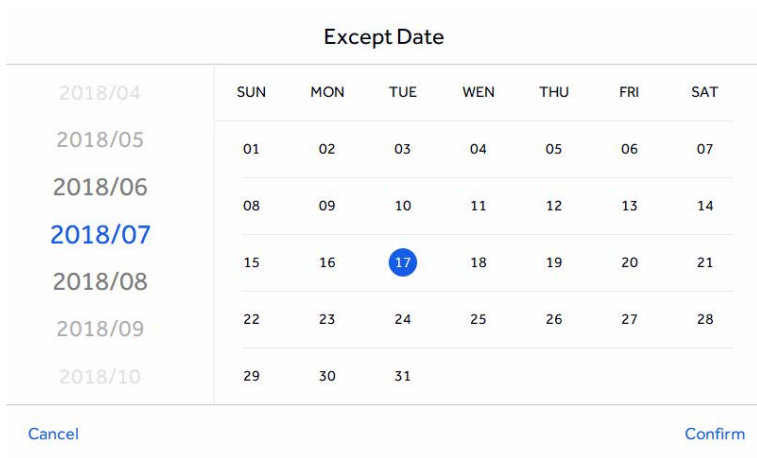

Picture 32

You can choose the date to add the “Except Date”. The “Except Date” represents the date when the corresponding schedule do not execute. The “Except Date” is set in the 6 months prior to the current date and within the time range of the current 2 years.

Setting

Tap “Setting” on the interface of Picture 3 to enter the setting interface, shown in Picture 34.

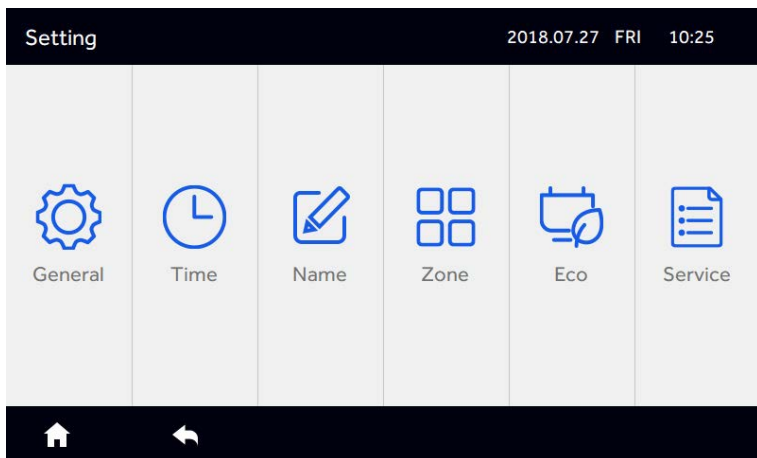

Picture 33

Function operation

1. General

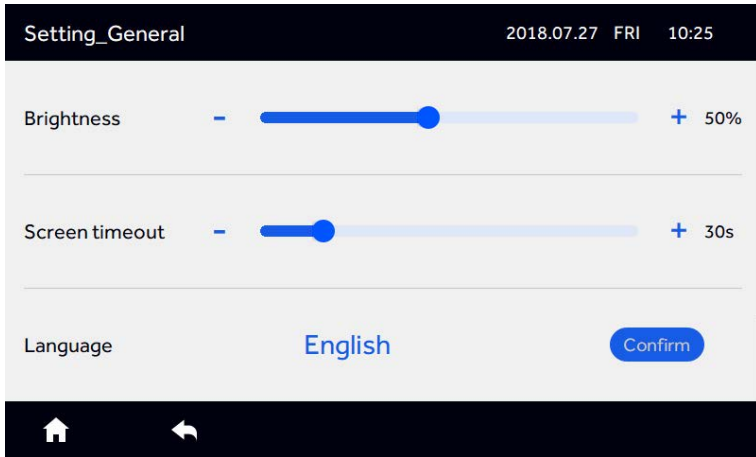

Picture 34

Slide up and down to the view all control setting

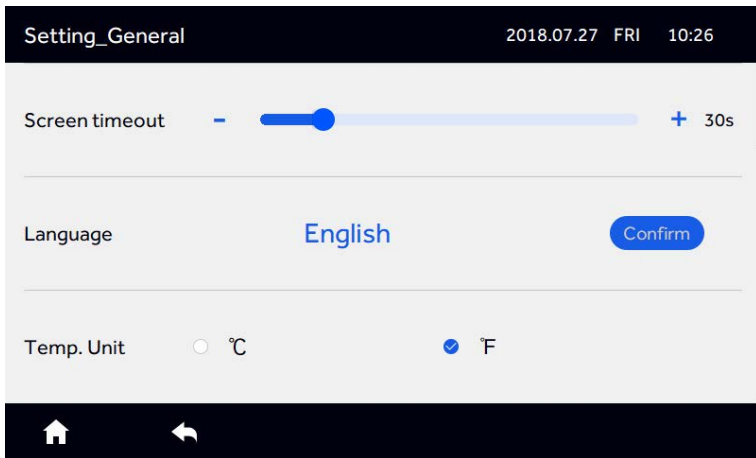

Picture 35

You can change the backlight brightness, Screensaver time and Fahrenheit switch by taping and dragging the slider, and currently only support English.

Function operation

2. Time

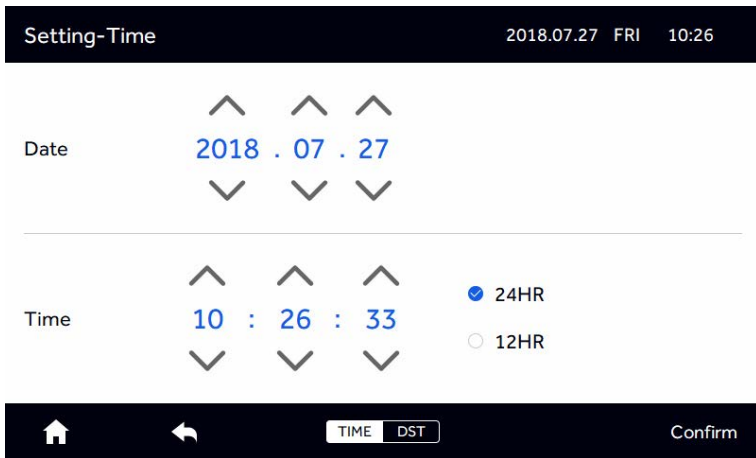

Picture 36

You can adjust the time by clicking the up and down arrow, you can tapping 24HR and 12HR to switch 24 hours or 12 hours.

Tap DST

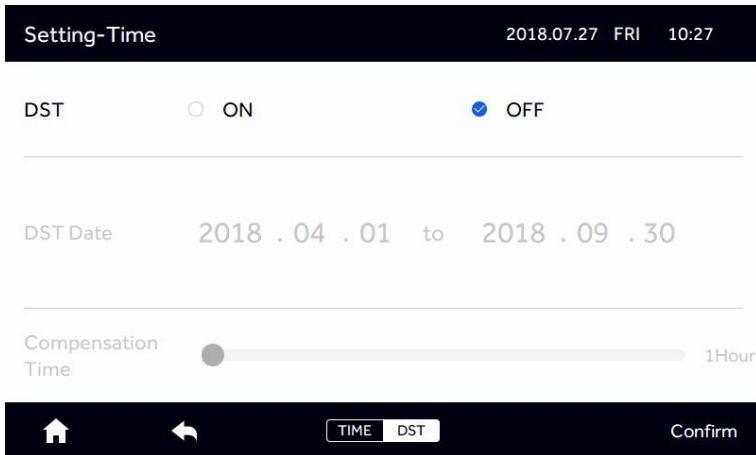

Picture 37

After tapping ON, the interface is as follows. You can tap the button to adjust the start and of the daylight saving time, and the time of the daylight saving time. The daylight time compensation can be 1-3 hours. The change needs to be confirmed by "Confirm".

Function operation

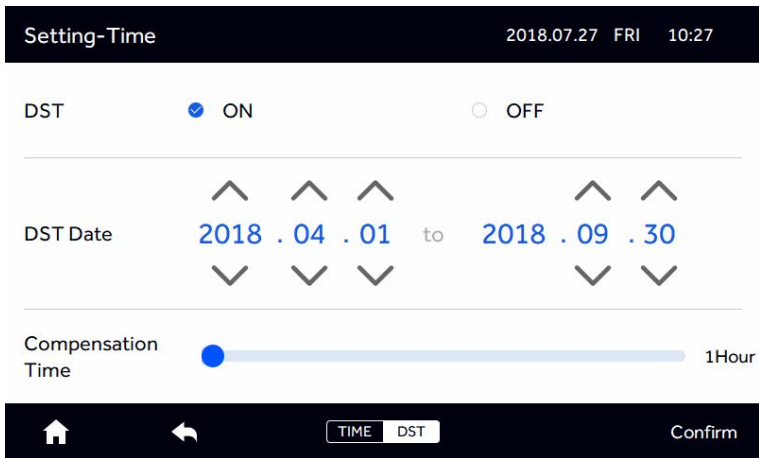

Picture 38

3. Name

Tap "Name" to enter the following interface.



Picture 39

Tap the indoor unit to rename.

Function operation



Picture 40

The upper left corner shows physical address: the "Physical address" of the machine, such as AC-5_4, represents the adapter address is 5, and the indoor centralized address is 4. It is convenient for the name and physical address to be checked. It needs to be confirmed by "Done".

4. Zone

Tap "Zone", as shown in Picture 41, Up to 32 group zones can be created.



Picture 41

Function operation

Tap “+”

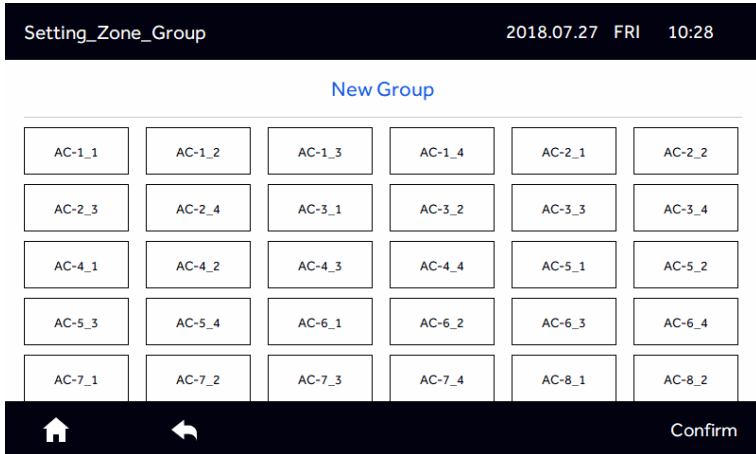

Picture 42

Select indoor units to be added to a zone.



Picture 43

Press “Confirm” to enter the following interface

Function operation

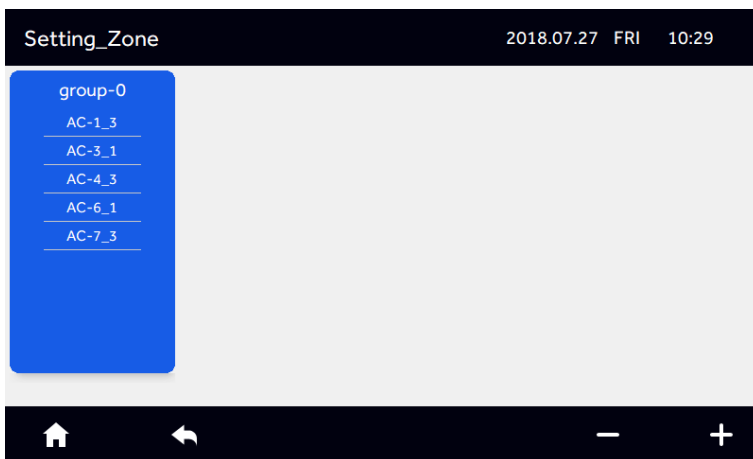

Picture 44

Then press “+”, select the indoor units that need to be added.



Picture 45

After press “Confirm”, add a new “Group”, as shown in Picture 45.

Function operation



Picture 46

Tap "-" at the lower right to select and delete the zone you want to delete.



Picture 47

Tap "-" at the lower right to select and delete a zone.

Function operation



Picture 48

Select a group then tap on current name to rename.

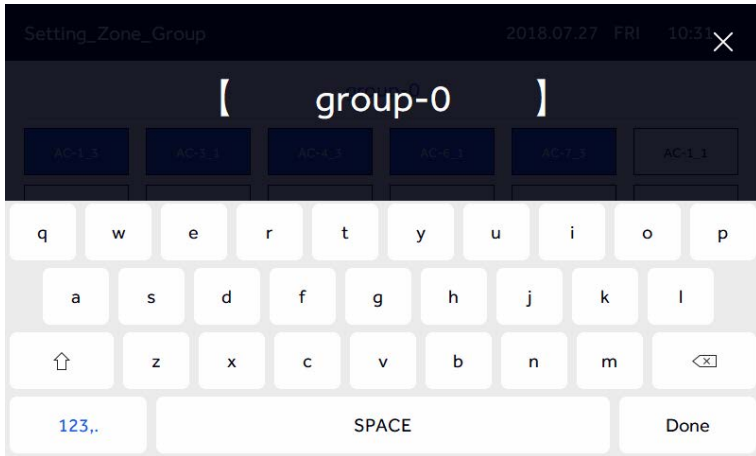

Picture 49

Press "Done" to save.

Function operation

ECO

Up to 16 energy saving parameters can be set.

In Picture 32, tap “Eco”,



Picture 50

Click “+” to add the indoor units that need to set energy saving.

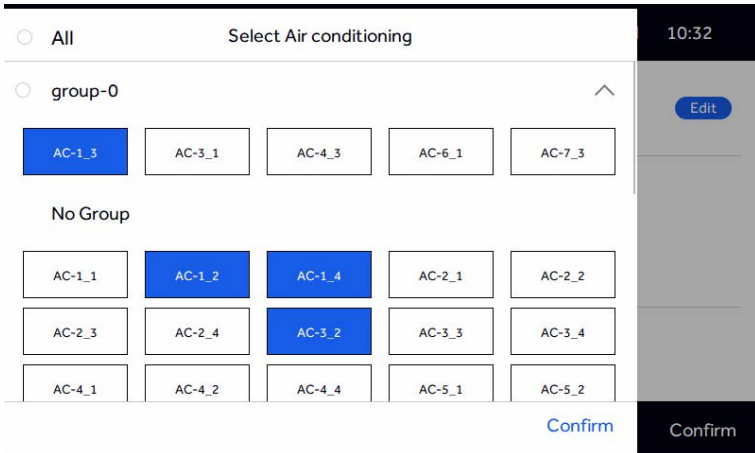

Picture 51

Function operation

After tap “Confirm”, enter the parameter settings of Eco, as shown in Picture 52.

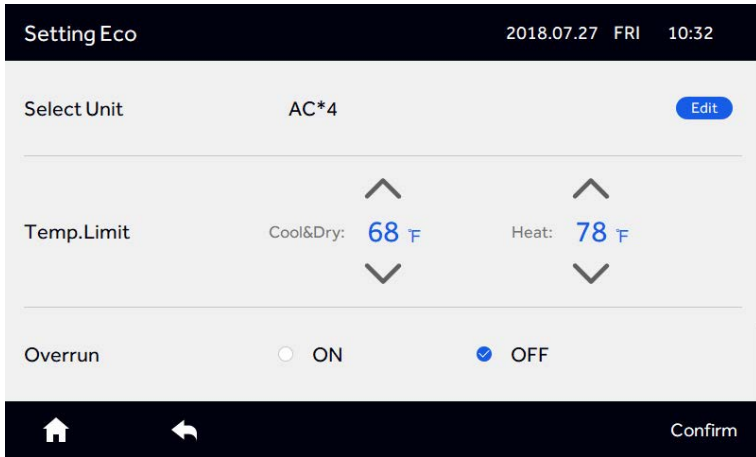

Picture 52

Slide up and down

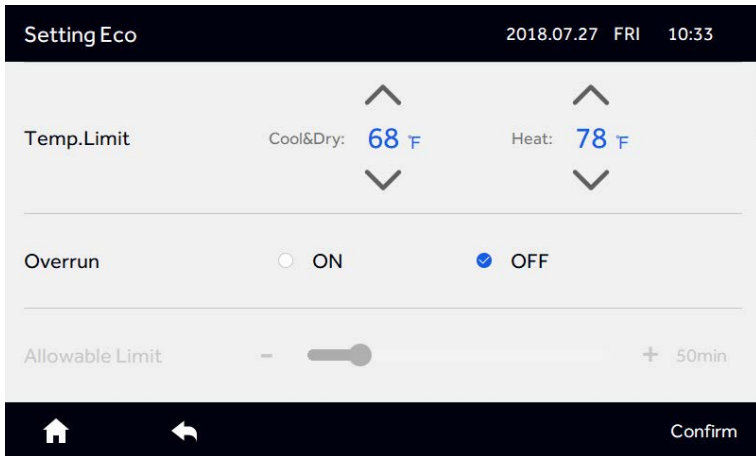

Picture 53

If you tap “Overrun” to ON, you can select Overrun’s time, and it can be adjusted from 10-240 minutes. Overrun mean the amount of time the temperatures can be set beyond the parameter by the user before the control returns it to within the limits set.

Function operation

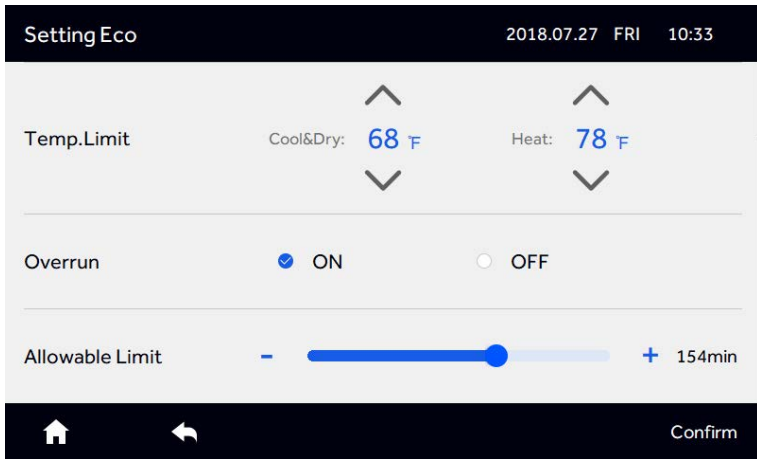

Picture 54

After tapping “Confirm”, the Eco setup information will show as seen in Picture 55.

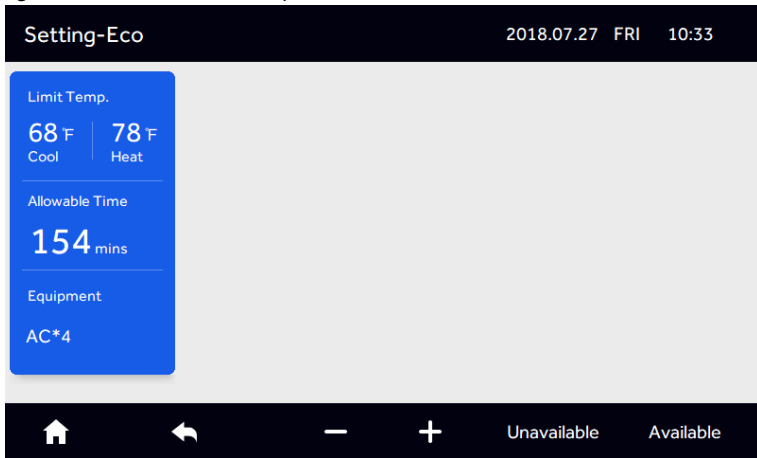

Picture 55

Tap “+” and repeat above steps to add another set of ECO parameters.

Function operation

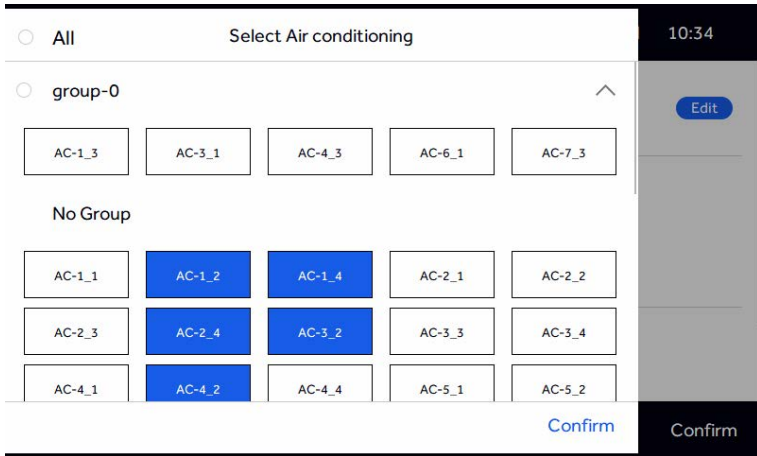

Picture 56

If an indoor unit is already included in a another ECO parameters, a warning prompt will appear.

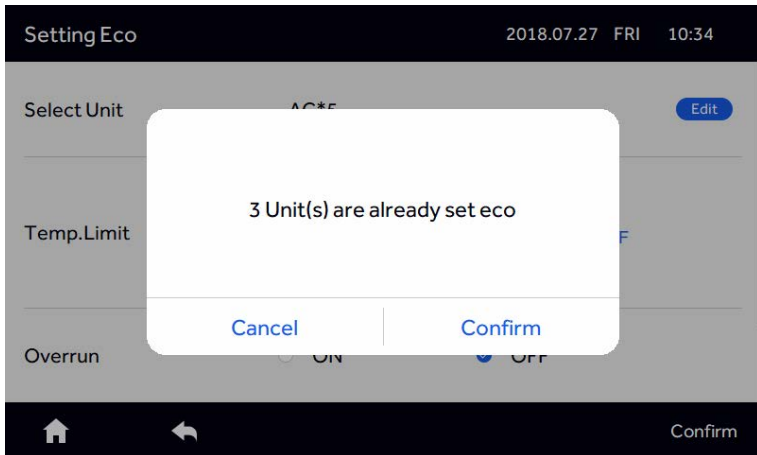

Picture 57

Tap "Confirm"

Function operation

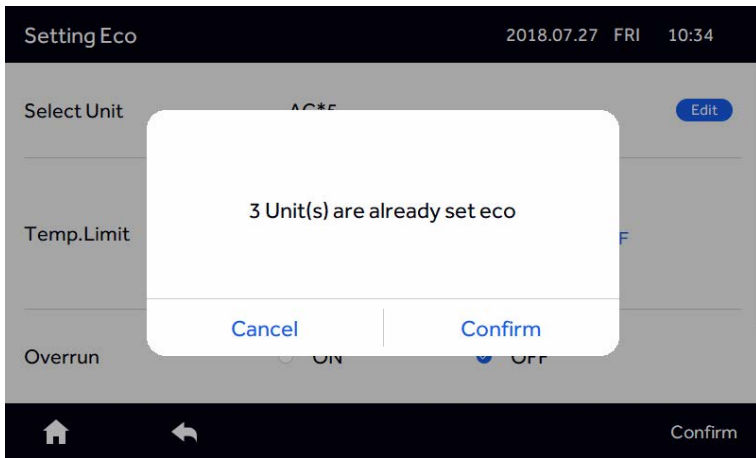

Picture 58

If you press “Confirm”, it is set successfully, the conflict indoor unit is cancelled from the previous setting, and the final ECO confirmation is confirmed. If you press “Cancel”, it returns to the previous setting interface.

After tap “-”, select the indoor unit that needs to be deleted, tap “Delete”.

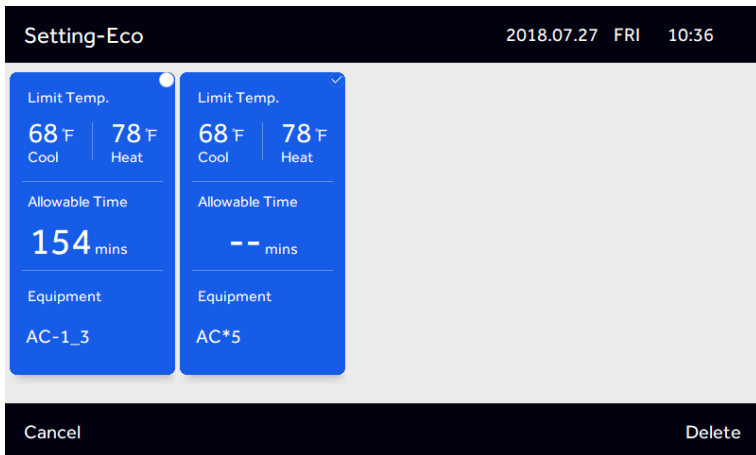

Picture 59

If you tap “Cancel”, returns to the upper layer.

Tap “Unavailable” to idle parameter settings. Press “Confirm” to save.

Function operation

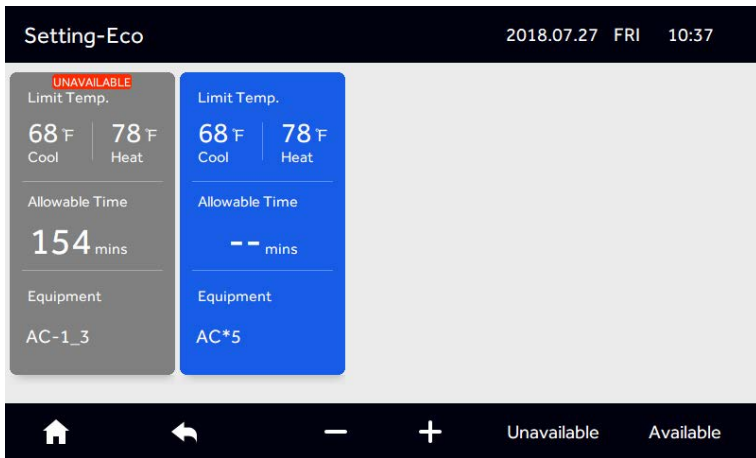

Picture 60

To restore idled parameters, tap “Available” then select the set that needs to be restored. Tap “Confirm” to save.

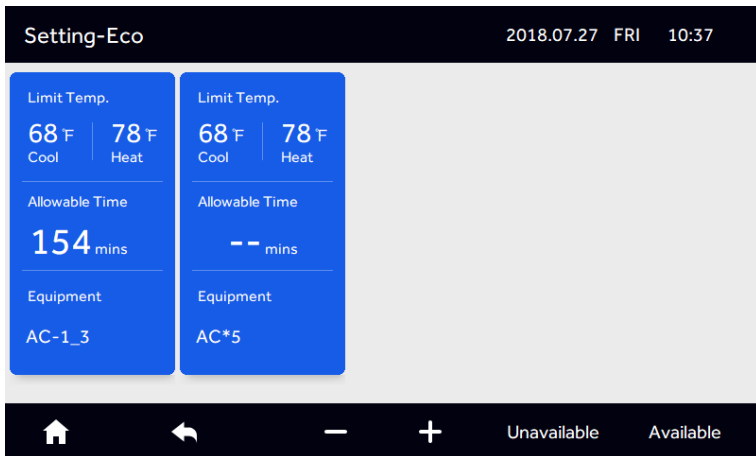

Picture 61

Function operation

5. Service

Tap “Service” in Picture 34 and tap “Confirm” on pop up that prompts to enter password.

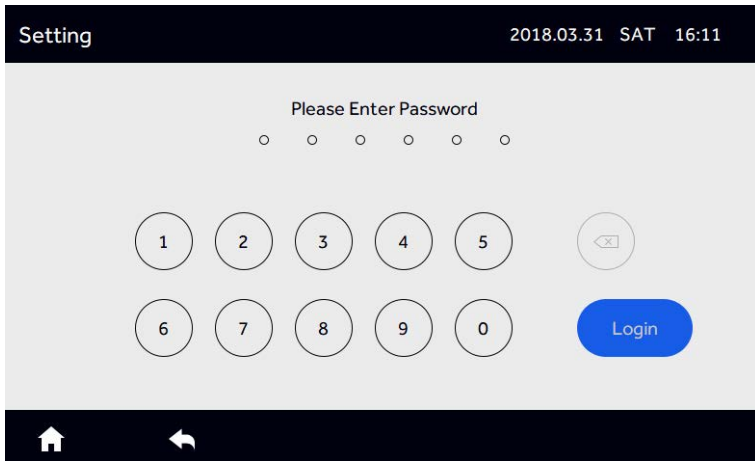

Picture 62

Enter password 841226 and tap “Login”.

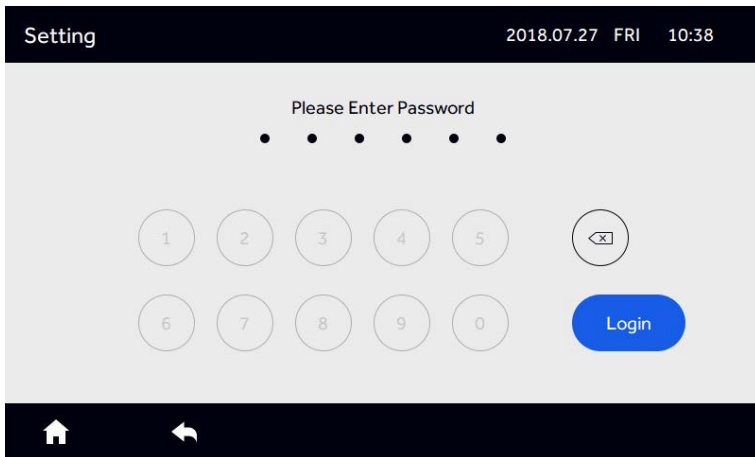

Picture 63

After clicking “Login”, go into Picture 64.

Function operation

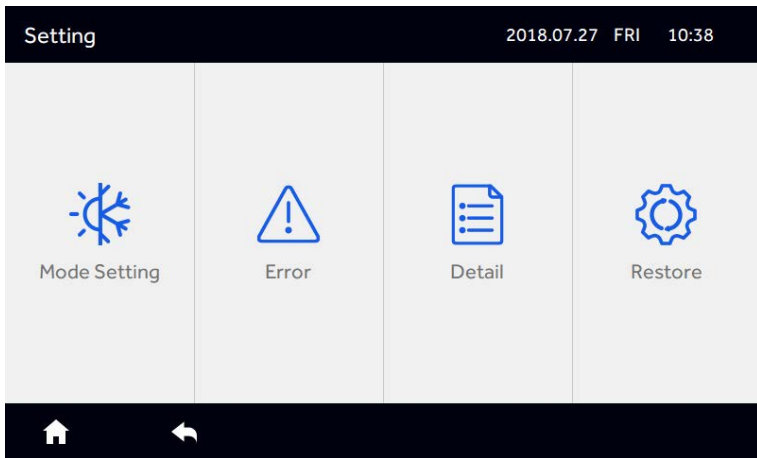

Picture 64

(1) Mode Setting

Click "Mode Setting" at the Picture 64 interface

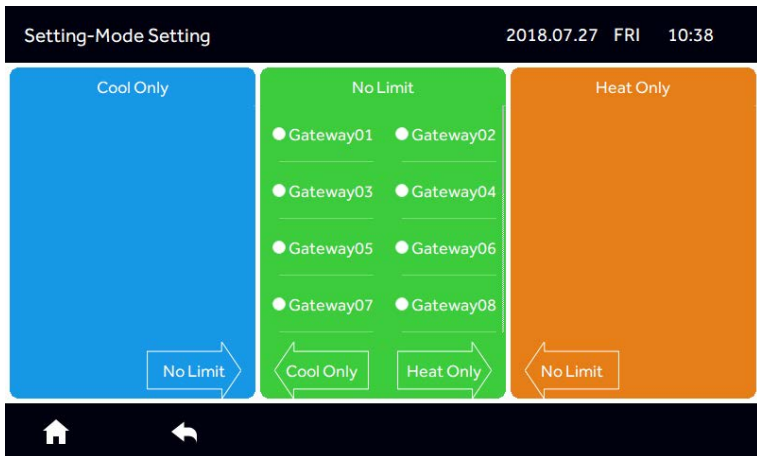

Picture 65

Select the system(s) that needs to be changed and tap the arrow to move to the next column.

Function operation

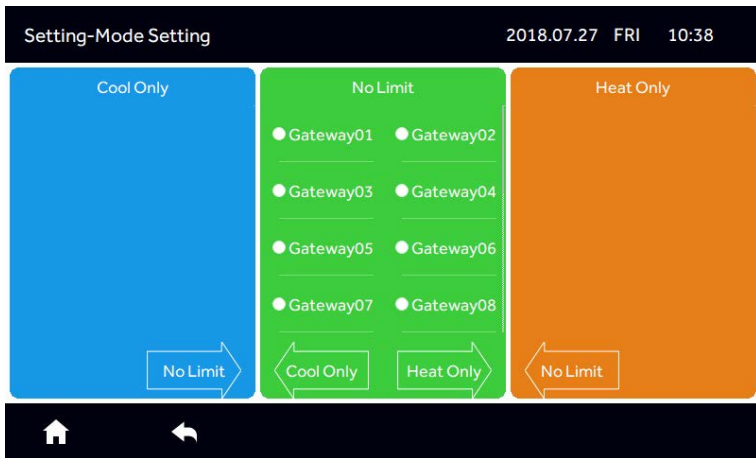

Picture 66

If you need to set up "Cool Only", then

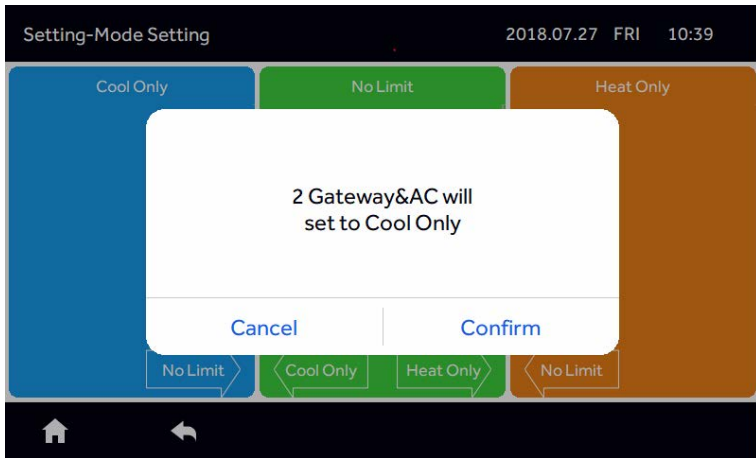

Picture 67

Tap "Confirm" to save changes.

Function operation

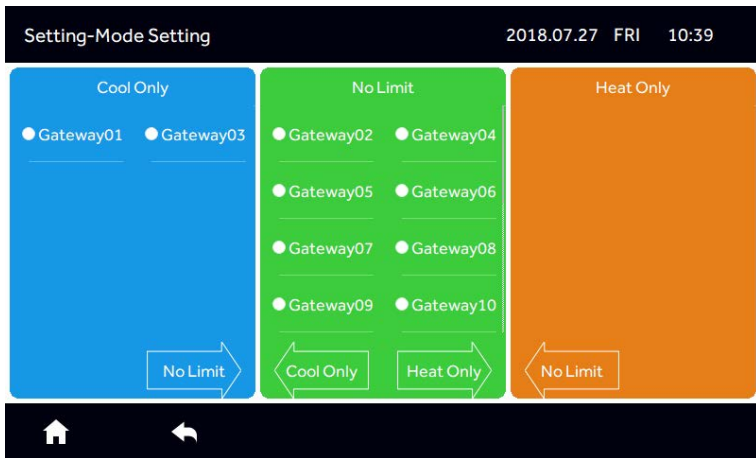

Picture 68

(2) Error
Tap “Error” in settings menu (Picture 64) to view errors.

Setting_Error				
2018.07.27 FRI 10:40				
Type	Equipment	Error Code	Date	Time
Current	AC-1_2	1	2018.07.27	10:03:07
	AC-1_3	2	2018.07.27	10:03:07
	AC-1_4	3	2018.07.27	10:03:07
	AC-2_1	4	2018.07.27	10:03:07
	AC-2_3	1	2018.07.27	10:03:07

Picture 69

You can slide up and down to see the fault information of other indoor units. Up to 10 faults will be saved for each unit.

Function operation

(3) Detail

Tap “Detail” in the settings menu (Picture 64) to view unit details such temperature readings, mode, current running time and errors (if any).

Setting_Detail								2018.07.27	FRI	10:40
Name	AC	Room temp.	Mode	Gas pipe Temp.	Liquid pipe Temp.	Running Time	Error			
AC-1_1	1-1	64°F	Cool	342 F	-64°F	00:38	0			
AC-1_2	1-2	66°F	Cool	342 F	-64°F	00:41	1			
AC-1_3	1-3	68°F	Cool	342 F	-64°F	00:41	2			
AC-1_4	1-4	70°F	Cool	342 F	-64°F	00:41	3			
AC-2_1	2-1	72°F	Fan	342 F	-64°F	00:40	4			

Picture 70

Other indoor units can be displayed by sliding up and down.

(4) Tapping “Restore” and “Confirm” will reset the control to factory defaults and clear all settings.

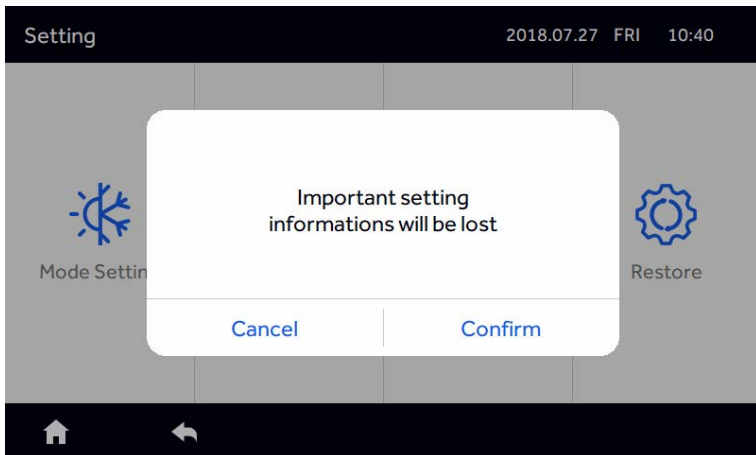

Picture 71

If you click “Confirm” to reinitialize, the controller start to search indoor units, if you click “Cancel”, then exit POP.

Wiring diagram and Installation

All of the communication 485 cables between each module and terminal module to the central controller are double core shielded twisted-pair cable. Specific wiring as the table below:

The length of signal line	Wiring dimension
≤ 100	$0.3 \text{ mm}^2 \times 2$
$100 < x \leq 200$	$0.5 \text{ mm}^2 \times 2$
$200 < x \leq 300$	$0.75 \text{ mm}^2 \times 2$
$300 < x \leq 400$	$1.25 \text{ mm}^2 \times 2$
$400 < x \leq 500$	$2 \text{ mm}^2 \times 2$

Installation condition

Don't install near devices that produce electrical interference such as AC motor, radio transmitters like network routers and consumer electronics.

Other electrical noise producers could include computers, auto-door openers, elevators, or other equipment what can produce noise.

Don't install in wet locations.

It will cause failure if you install in a place that shakes violently.

Don't install in the place where it is exposed to direct sunlight or near to the heat. This will cause failure.

Mounting Control

First, attach the mounting plate to the wall. Using a job box is preferred. Use A and B holes for an 86mm box, use C and D holes for a 120mm box. Please take note of the UP indicator.

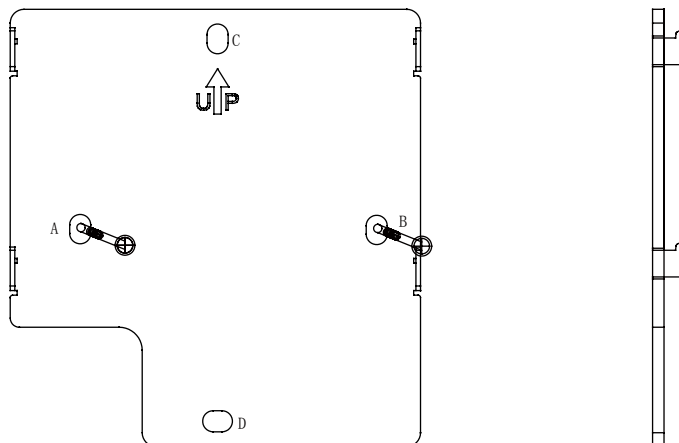

Wiring diagram and Installation

Place the board, AB for 86 cassettes, CD for 120 cassettes. The hanger should be fixed as the picture, please note the UP direction.

The hanging plate is placed in the direction of the illustration, where A/B is the location of the 86 cassette screws, and the C/D is the position of the 120 cassette screws.

The pendant is fixed to the hole of the pendant, please pay attention to the UP direction.

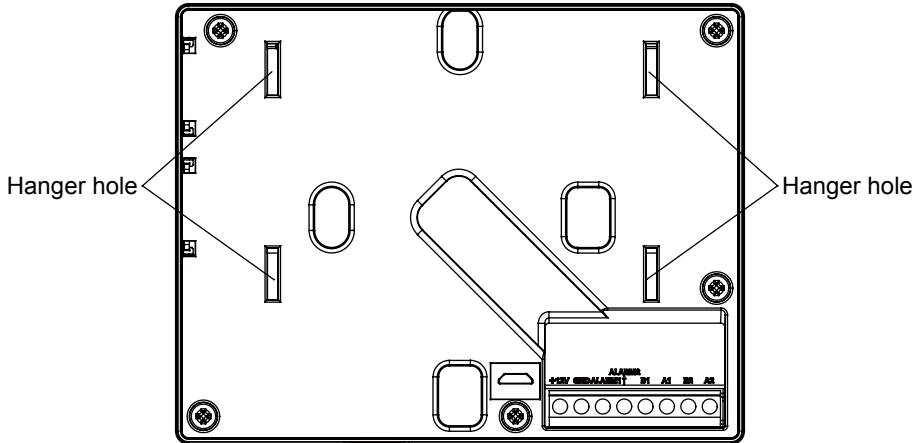

Wiring diagram and Installation

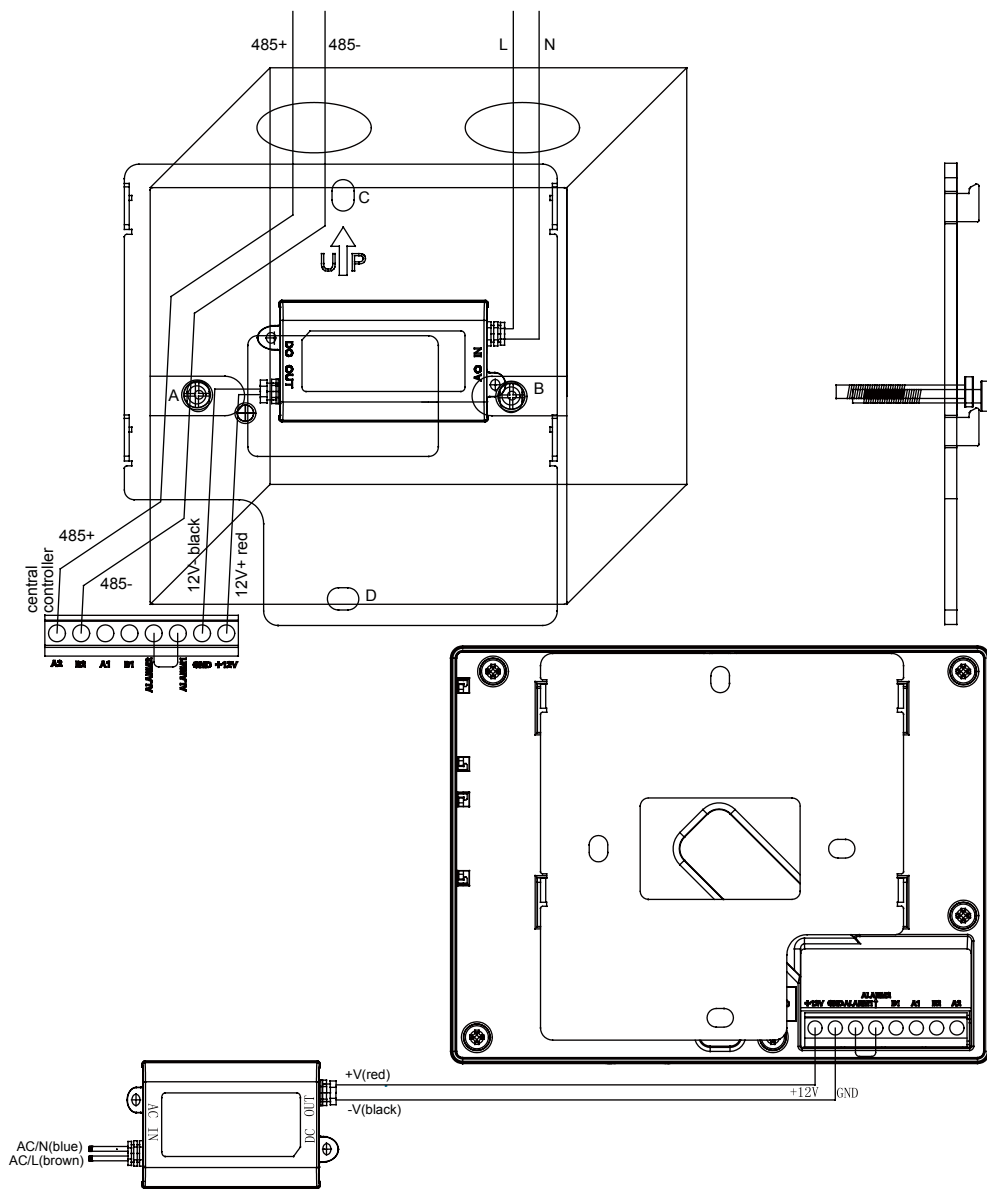

Wiring diagram and Installation

Wiring between power adapter and central controller.

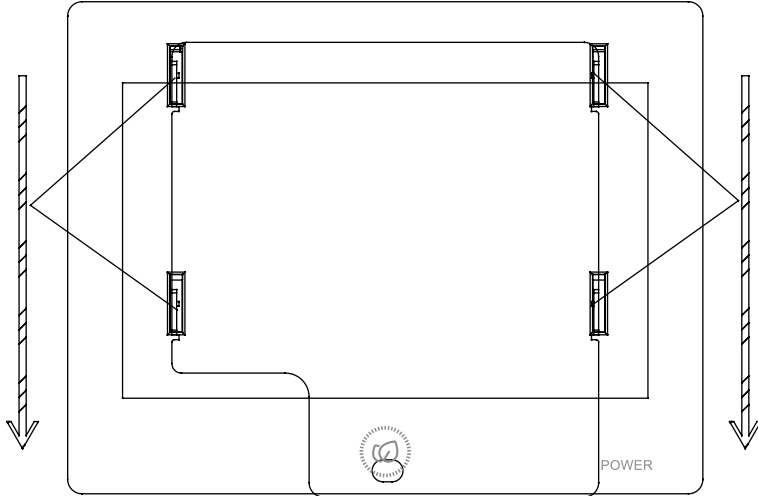

Central Controller Dimension:

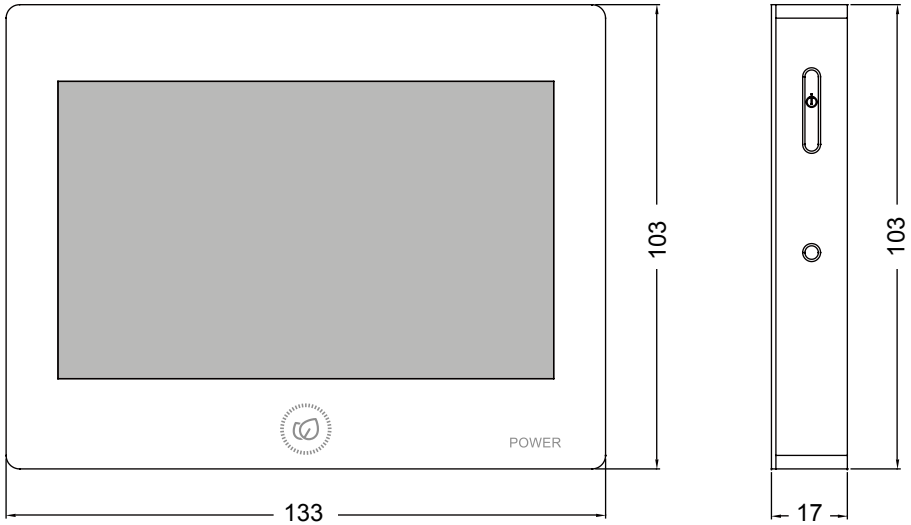

Wiring diagram and Installation

Fix the screw through the bracket on the 86 cassettes and connect the connection. The adapter's AC IN connects to the L and N of 220V, the V+ (RED) collector of the AC OUT, and the AC OUT. Please pay attention to the line sequence. Then the central controller is fixed down.

Notes:

1. B1A1 is a third party interface, paying attention to the line order.
2. ARALM1 and ALARM2 factory default is connection; if not connection, then the main interface of the central controller will display alarm information, and all indoor units will be turned off.
3. Third party interface
Through the A1B1 interface, it can access third party devices, and can realize the monitoring and control of third party devices to the central controller.

Wiring diagram and Installation

1. Discrete Input--Query Function Code: 0x02

BIT	name	meaning	remark
0	indoor 1 existent non existent	0- non existent 1-existent	The indoor unit that has never been answered after the indoor unit is started is regarded as does not exist
1	indoor unit 1 status (whether online)	0-not online 1-on line	The indoor unit check by the outdoor unit , Dropped offline is not online,The outdoor unit is judged to be online and re-set it online
2	indoor 2 existent non existent	0- non existent 1-existent	The indoor unit that has never been answered after the indoor unit is started is regarded as does not exist
3	indoor unit 2 status (whether online)	0- not online 1- on line	The indoor unit check by the outdoor unit , Dropped offline is not online,The outdoor unit is judged to be online and re-set it online
.....			
126	indoor64 existent non existent	0- non existent 1-existent	The indoor unit that has never been answered after the indoor unit is started is regarded as does not exist
127	indoor unit 2 status (whether online)	0- not online 1- on line	The indoor unit check by the outdoor unit , Dropped offline is not online,The outdoor unit is judged to be online and re-set it online

Wiring diagram and Installation

2. Coil--Query function code: 0x01 Control function code: 0x05/0x0F

BIT	name	meaning	reamrk
0	indoor unit 1 on off	0- off 1- on	Read operation to get the current indoor unit on and off status Write operation changes the indoor unit on and off state
1	indoor unit 2 on off	0-off 1-on	Read operation to get the current indoor unit on and off status Write operation changes the indoor unit on and off state
2	indoor unit 3 on off	0- off 1- on	Read operation to get the current indoor unit on and off status Write operation changes the indoor unit on and off state
3	indoor unit 4 on off	0- off 1- on	Read operation to get the current indoor unit on and off status Write operation changes the indoor unit on and off state
.....			
62	indoor unit 63 on off	0- off 1- on	Read operation to get the current indoor unit on and off status Write operation changes the indoor unit on and off state
63	indoor unit 64 on off	0- off 1- on	Read operation to get the current indoor unit on and off status Write operation changes the indoor unit on and off state

Trane - by Trane Technologies (NYSE: TT), a global climate innovator - creates comfortable, energy efficient indoor environments for commercial and residential applications. For more information, please visit trane.com or tranetechnologies.com.

Trane has a policy of continuous product and product data improvement and reserves the right to change design and specifications without notice. We are committed to using environmentally conscious print practices.