



## Installation Instructions

# Trane Rental Services

## Cooling Towers

### SAFETY WARNING

Only qualified personnel should install and service the equipment. The installation, starting up, and servicing of heating, ventilating, and air-conditioning equipment can be hazardous and requires specific knowledge and training. Improperly installed, adjusted or altered equipment by an unqualified person could result in death or serious injury. When working on the equipment, observe all precautions in the literature and on the tags, stickers, and labels that are attached to the equipment.



# Introduction

Read this manual thoroughly before operating or servicing this unit.

## Warnings, Cautions, and Notices

Safety advisories appear throughout this manual as required. Your personal safety and the proper operation of this machine depend upon the strict observance of these precautions.

The three types of advisories are defined as follows:

- ⚠ WARNING** Indicates a potentially hazardous situation which, if not avoided, could result in death or serious injury.
- ⚠ CAUTION** Indicates a potentially hazardous situation which, if not avoided, could result in minor or moderate injury. It could also be used to alert against unsafe practices.
- NOTICE** Indicates a situation that could result in equipment or property-damage only accidents.

## Important Environmental Concerns

Scientific research has shown that certain man-made chemicals can affect the earth's naturally occurring stratospheric ozone layer when released to the atmosphere. In particular, several of the identified chemicals that may affect the ozone layer are refrigerants that contain Chlorine, Fluorine and Carbon (CFCs) and those containing Hydrogen, Chlorine, Fluorine and Carbon (HCFCs). Not all refrigerants containing these compounds have the same potential impact to the environment. Trane advocates the responsible handling of all refrigerants.

## Important Responsible Refrigerant Practices

Trane believes that responsible refrigerant practices are important to the environment, our customers, and the air conditioning industry. All technicians who handle refrigerants must be certified according to local rules. For the USA, the Federal Clean Air Act (Section 608) sets forth the requirements for handling, reclaiming, recovering and recycling of certain refrigerants and the equipment that is used in these service procedures. In addition, some states or municipalities may have additional requirements that must also be adhered to for responsible management of refrigerants. Know the applicable laws and follow them.

**⚠ WARNING**

**Proper Field Wiring and Grounding Required!**

Failure to follow code could result in death or serious injury. All field wiring **MUST** be performed by qualified personnel. Improperly installed and grounded field wiring poses **FIRE** and **ELECTROCUTION** hazards. To avoid these hazards, you **MUST** follow requirements for field wiring installation and grounding as described in **NEC** and your local/state/national electrical codes.

**⚠ WARNING**

**Personal Protective Equipment (PPE) Required!**

Failure to wear proper PPE for the job being undertaken could result in death or serious injury. Technicians, in order to protect themselves from potential electrical, mechanical, and chemical hazards, **MUST** follow precautions in this manual and on the tags, stickers, and labels, as well as the instructions below:

- Before installing/servicing this unit, technicians **MUST** put on all PPE required for the work being undertaken (Examples; cut resistant gloves/sleeves, butyl gloves, safety glasses, hard hat/bump cap, fall protection, electrical PPE and arc flash clothing). **ALWAYS** refer to appropriate Safety Data Sheets (SDS) and OSHA guidelines for proper PPE.
- When working with or around hazardous chemicals, **ALWAYS** refer to the appropriate SDS and OSHA/GHS (Global Harmonized System of Classification and Labeling of Chemicals) guidelines for information on allowable personal exposure levels, proper respiratory protection and handling instructions.
- If there is a risk of energized electrical contact, arc, or flash, technicians **MUST** put on all PPE in accordance with OSHA, NFPA 70E, or other country-specific requirements for arc flash protection, **PRIOR** to servicing the unit. **NEVER PERFORM ANY SWITCHING, DISCONNECTING, OR VOLTAGE TESTING WITHOUT PROPER ELECTRICAL PPE AND ARC FLASH CLOTHING. ENSURE ELECTRICAL METERS AND EQUIPMENT ARE PROPERLY RATED FOR INTENDED VOLTAGE.**

**⚠ WARNING****Follow EHS Policies!**

Failure to follow instructions below could result in death or serious injury.

- All Trane personnel must follow the company's Environmental, Health and Safety (EHS) policies when performing work such as hot work, electrical, fall protection, lockout/tagout, refrigerant handling, etc. Where local regulations are more stringent than these policies, those regulations supersede these policies.
- Non-Trane personnel should always follow local regulations.

## Copyright

This document and the information in it are the property of Trane, and may not be used or reproduced in whole or in part without written permission. Trane reserves the right to revise this publication at any time, and to make changes to its content without obligation to notify any person of such revision or change.

## Trademarks

All trademarks referenced in this document are the trademarks of their respective owners.

## Revision History

500 ton cooling tower drawing updated in 500 Ton Cooling Tower chapter.



# Table of Contents

General Information	5
Cooling Towers Overview	5
Unit Dimensions and Weights	6
Lifting, Mounting, and Transportation	6
270-tons	6
500 and 1000-tons	6
Rigging Guidelines	6
General Guidelines (not applicable to all models and sizes)	6
Dimensional Drawings	8
Electrical Data	11
Cooling Tower Piping Kit and Water Connections	13
270 Ton Water Connections/Piping Kit	13
CSCT0270F0 Style Towers	13
500 Ton Water Connections/Piping Kit	14
Piping Kit Assembly	14
1000 Ton Water Connections/Piping Kit	16
Piping Kit Assembly	16
Start-Up	19
270 Ton Tower (CSCT0270F0) Startup	19
500 Ton Tower (CSCT0500F1) Startup	20
1000 Ton Tower (RSCT1000F2) Startup	22
Maintenance	24
Water Treatment Recommendations	24
Control of Biological Contamination	24
Air Contamination	24
270 Ton Cooling Tower	26
Features	26
Dimensional Drawings	27
500 Ton Cooling Tower	28
Features	28
Dimensional Drawings	29
1000 Ton Cooling Tower	30
Features	30
Dimensional Drawings	31



# General Information

**⚠ WARNING**

**Live Electrical Components!**

Failure to follow all electrical safety precautions when exposed to live electrical components could result in death or serious injury. When it is necessary to work with live electrical components, have a qualified licensed electrician or other individual who has been properly trained in handling live electrical components perform these tasks.

**⚠ WARNING**

**Proper Field Wiring and Grounding Required!**

Failure to follow code could result in death or serious injury. All field wiring MUST be performed by qualified personnel. Improperly installed and grounded field wiring poses FIRE and ELECTROCUTION hazards. To avoid these hazards, you MUST follow requirements for field wiring installation and grounding as described in NEC and your local/state/national electrical codes.

Cooling towers in the rental fleet include as in below [Table 1](#).

Towers are nominally rated for flow and tonnage at the industrial standard Cooling Technology Institute (CTI) conditions with entering water temperature (EWT) of 95°F, leaving water temperature (LWT) of 85°F, entering wet bulb temperature (EWB) of 78°F and three gallons per minute per ton. For other flows and temperature conditions, contact Trane Rental Services.

The ambient operating temperature for the towers is 35°F to 140°F. All are equipped with basin heaters to provide low temperature protection when properly installed. For ambient temperatures below 40°F, the basin heaters must be used.

Pumps, flexible water hose, transformers, and other accessories are available upon request.

## Cooling Towers Overview

**Note:** All information contained in this document is for reference only.

CSCT0270F0XX - 270-ton nominal cooling tower (810 GPM)

CSCT0500F1XX - 500-ton nominal cooling tower (1500 GPM)

RSCT1000F2XX - 1000-ton nominal cooling tower (3000 GPM)

**Note:** Where XX represents the unique inventory number.

**Table 1. Cooling tower**

	Nominal Tons		
	270	500	1000
Manufacturer	Baltimore Air Coil®	Evapco®	Reymosa®
Inlet Water Connection Qty/Size/Type	(1) 6 in. Victaulic	(2) 6 in. Victaulic	(2) 8 in. Victaulic
Outlet Water Connection Qty/Size/Type	(1) 6 in. Victaulic	(2) 10 in. Victaulic	(2) 10 in. Victaulic
Make-Up Water Connection Qty/Size/Type	(1) 2 in. MPT	(2) 2 in. MPT	(2) 1.5 in. FPT
Overflow Connection Qty/Size/Type	(1) 3 in. FPT	(2) 3 in. FPT	(2) 2 in. FPT
Drain Connection Qty/Size/Type	(1) 2 in. FPT	(2) 3 in. FPT	(2) 2 in. FPT
Nominal Flow Rate	810 GPM	1500 GPM	3000 GPM
Number of Cells	1	2	2
Number of Fans/Cell	1	1	8
Drive Type	Belt	Belt	Direct
Capacity Control	Fan Cycling	Fan Cycling	Variable Speed Fans
Max Make-Up Water Valve Pressure	20-50 PSI	20-50 PSI	20-50 PSI
Make-up Water Control	Mechanical Float Valve	Mechanical Float Valve	Mechanical Float Valve
Construction Type	All Metal	All Metal	Fiberglass
Operating Principle	Forced Draft, Counterflow	Induced Draft, Counterflow	Induced Draft, Counterflow
Fill Material	PVC	PVC	PVC
Max Fill Operating Temperature <sup>(a)</sup>	130°F	130°F	130°F

(a) Higher Operating Temperatures will cause permanent damage to fill.



# Unit Dimensions and Weights

## Lifting, Mounting, and Transportation

500 and 1000-ton towers are mounted on dedicated 48-ft drop-deck trailers. The 500-ton cooling tower can be removed from the trailer. Refer to the rigging guidelines section of this manual. All 500-ton towers are equipped with forklift pockets. 1000-ton towers are permanently mounted to trailer and should not be removed.

### 270-tons

- Modified for easy installation.
- Designed to comply with transportation height requirements for industrial, flatbed trailers.
- Equipped with forklift pocket and crane lifting eyes.

### 500 and 1000-tons

- Modified to meet transportation dimensional requirements.
- Drop-deck trailer configuration required to comply with transportation height requirements.

**Table 2. CSCT0270, 500, RSCT1000 weights and dimensions**

Model	CSCT0270F0	CSCT0500F1 <sup>(a)</sup>	RSCT1000F2 <sup>(a)</sup>
Nominal Tons	270	500	1000
Length	20 ft	48 ft	48 ft 4 in.
Width	8 ft	8 ft 6 in.	8 ft 6 in.
Height	8 ft 2 in.	13 ft 6 in.	13 ft 6 in.
Shipping Weight (lbs)	6,500	24,960	27,600
Operational Weight (lbs)	10,700	32,580	52,280
Level Requirements (end to end)	1/8 in.		

(a) Includes weight and dimension of trailer.

## Rigging Guidelines

**⚠ WARNING**

**Heavy Objects!**

Failure to follow instructions below could result in unit dropping which could result in death or serious injury, and equipment or property-only damage. Ensure that all the lifting equipment used is properly rated for the weight of the unit being lifted. Each of the cables (chains or slings), hooks, and shackles used to lift the unit must be capable of supporting the entire weight of the unit. Lifting cables (chains or slings) may not be of the same length. Adjust as necessary for even unit lift.

- When tower is removed from trailer, mark the exact location of tower on trailer. Tower should be replaced in the same location with outlet water connections on the same side of the trailer. The trailer must be returned in the same condition in which it was delivered.
- Lifting plates are located on each side of the top of the 500-ton towers. Fork pockets are located in the base of the tower. Lifting eyes are located on each side of the bottom of the 270-ton towers.
- Drain, clean basin, and disconnect any piping and wiring before returning unit to trailer. 500-ton dual outlet towers should be positioned with 10 inch outlet connections on passenger side of trailer.
- When tower is reloaded in the original position, reconnect turnbuckles (if equipped) and tighten to secure to trailer.

## General Guidelines (not applicable to all models and sizes)

**Important:** 1000 Ton Cooling Tower is permanently trailer mounted.

- If tower is removed from trailer, the foundation on which the tower will be operating from must support the operating weight of the tower.
- If tower remains on the trailer, operating weight will impact the landing gear and tires. Cribbing or weight distribution plates may be required.

Figure 1. 500-ton tower rigging connections

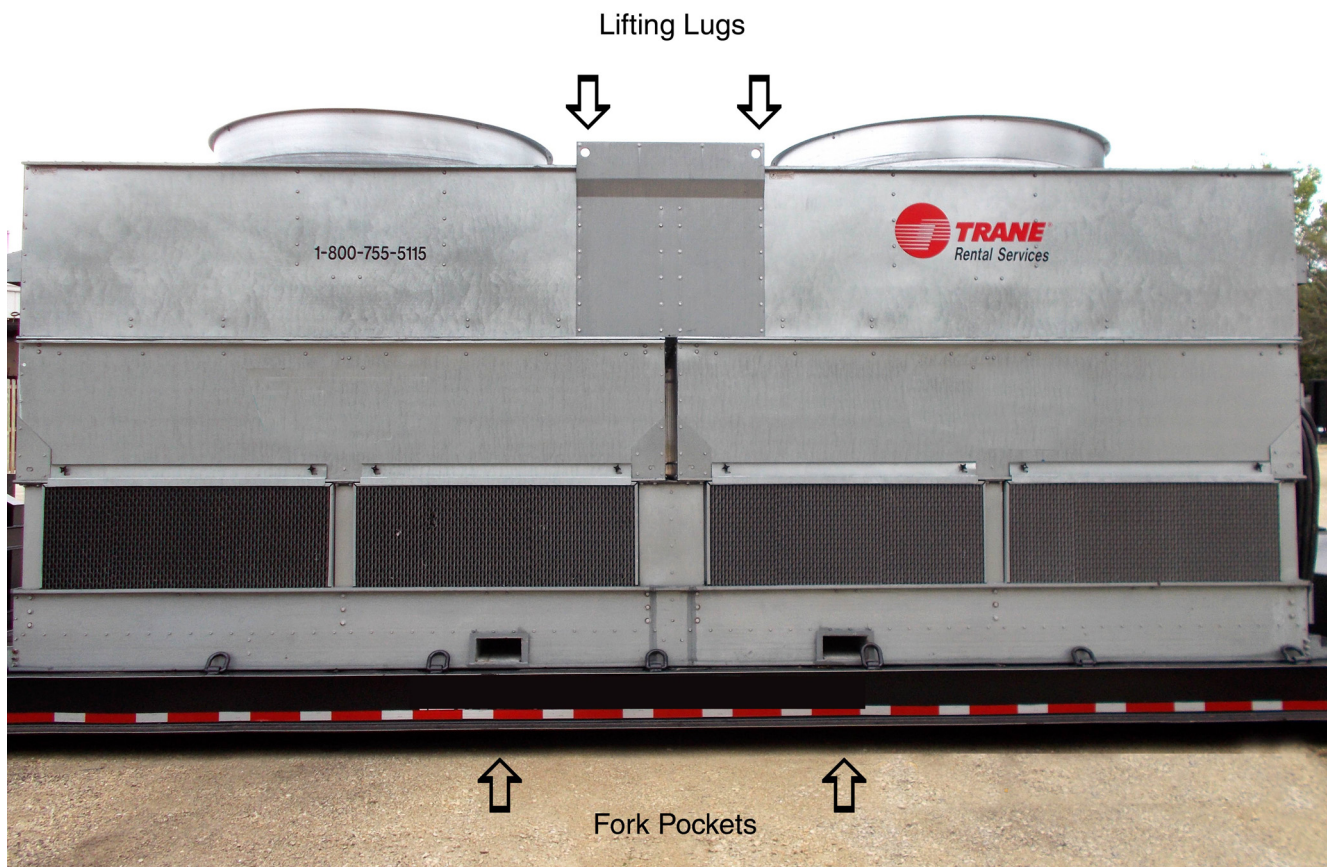



# Unit Dimensions and Weights

## Dimensional Drawings

Figure 2. 270-ton (CSCT0270F0) cooling tower line drawing - Drawing does not show exact location of inlet piping.

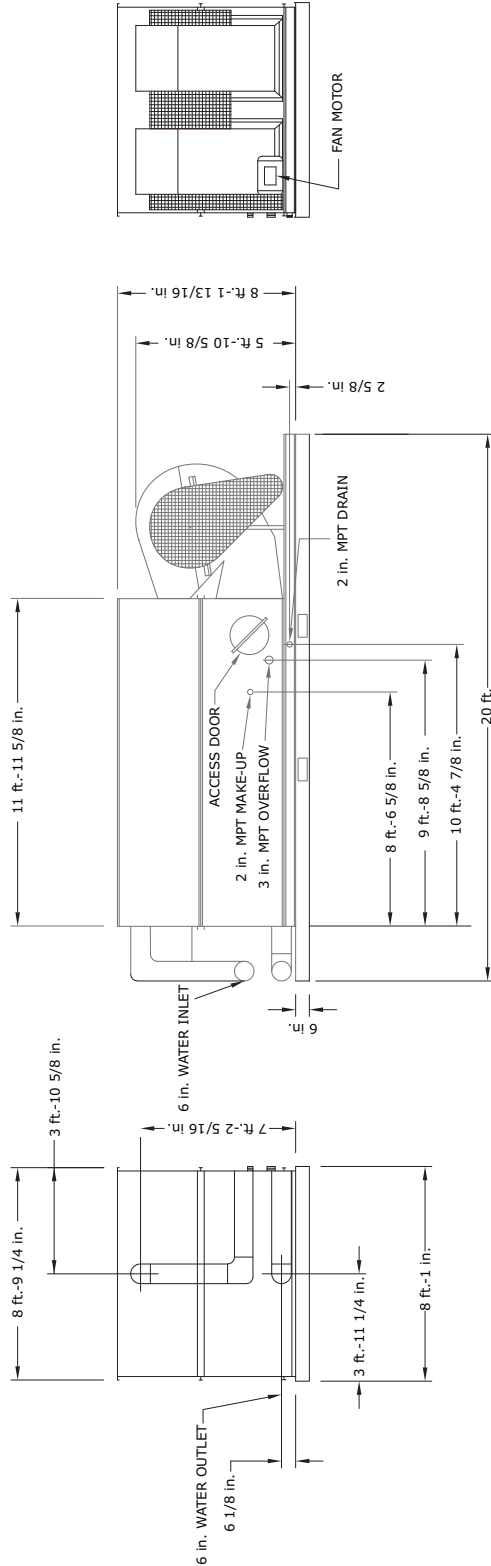
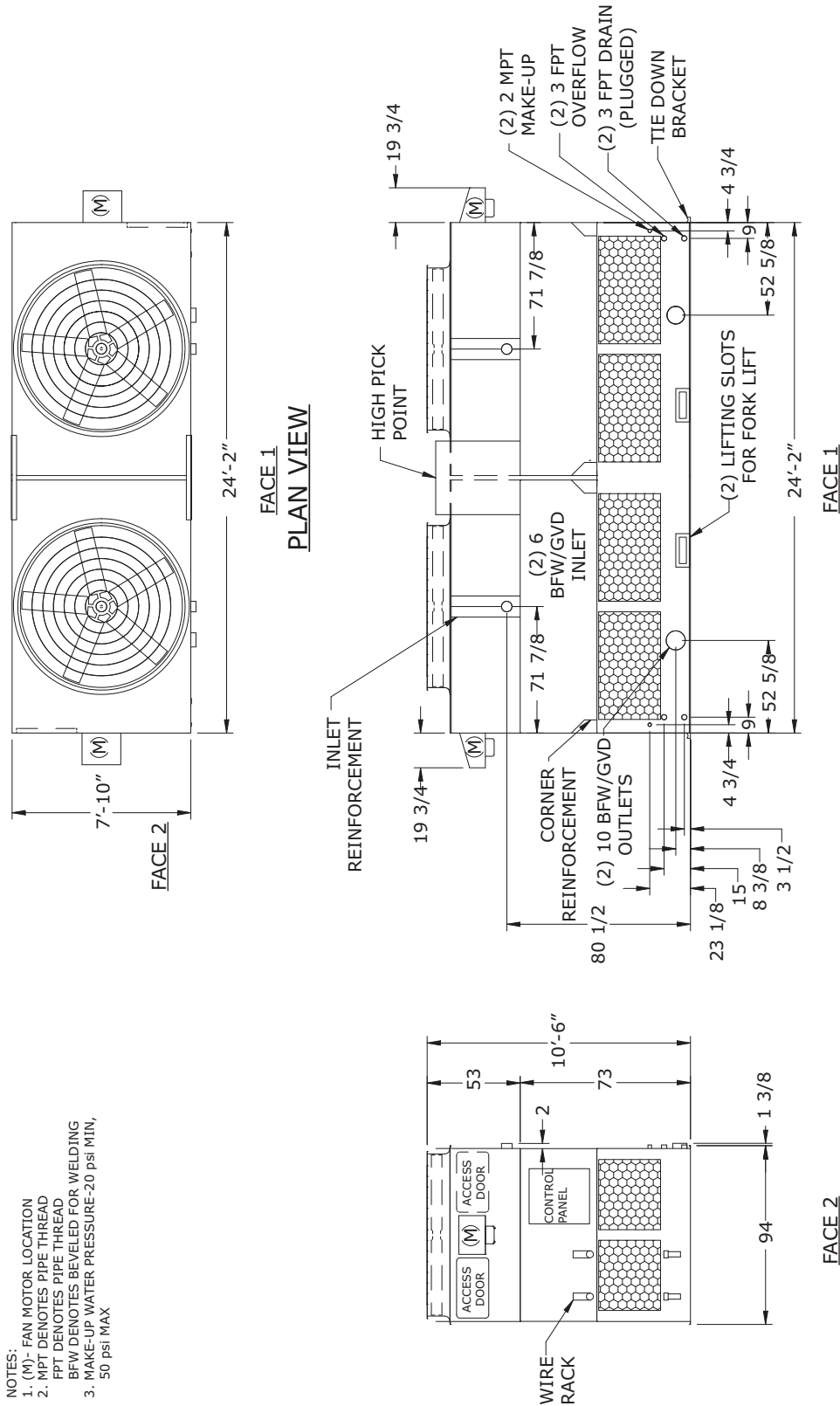



Figure 3. 500-ton (CSCT0500F1) cooling tower line drawing



- NOTES:
1. (M)- FAN MOTOR LOCATION
  2. MPT DENOTES PIPE THREAD  
FPT DENOTES PIPE THREAD  
BFW DENOTES REVELED FOR WELDING
  3. MAKE-UP WATER PRESSURE-20 psi MIN,  
50 psi MAX

# Unit Dimensions and Weights

Figure 4. 1000-ton (RSCT1000F2) cooling tower line drawing

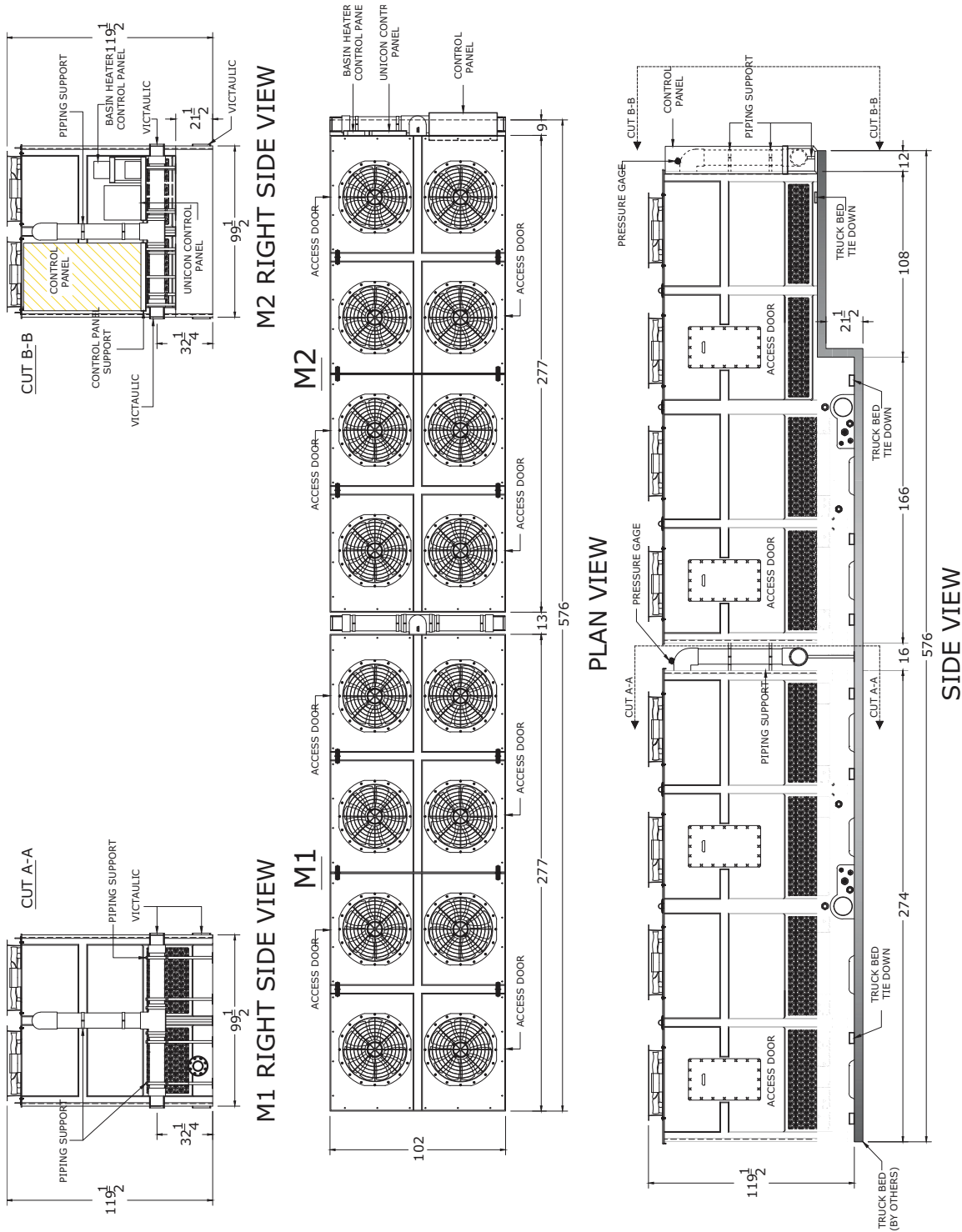



# Electrical Data

**Table 3. CSCT0270, 500, RSCT1000 electrical data**

Model	CSCT0270F0*	CSCT0500F1*	RSCT1000F2*
Disconnect Type	Circuit Breaker - 150 Amp	Non-Fused Switch - 100 Amp	Circuit Breaker - 300 Amp
Wire Connection Type	Series 16 Cam-Type Only	Series 16 Cam-Type Only	Series 16 Cam-Type Only
MCA	75.8 A	76.5 A	180.0 A
MOP	150 A	100 A	300 A
Fan Motor Qty - Size - Type	(1) 40 HP - TEFC	(2) 25 HP - TEFC	(16) 5 HP - EC
Fan Motor Qty - RLA	(1) 52.0 A	(2) 34.0 A	(16) 4.7 A
Basin Heater Qty - Size	(1) 9 kW	(2) 6 kW	(4) 8 kW
Basin Heater FLA	(1) 10.8 A	(2) 7.2 A	(4) 9.63 A
Vibration Switch	Yes	Yes	No
SCCR	5kAIC	5kAIC	65kAIC

**Note:** All towers are 460V, 3-phase, 60 Hz.

**Figure 5. 270-ton CT motor control panel end**



**Figure 6. 500-ton CT control panel end**

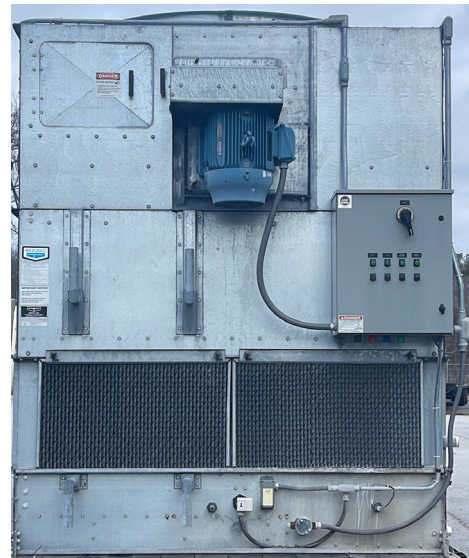



Electrical Data

---

Figure 7. 1000-ton CT control panel end





# Cooling Tower Piping Kit and Water Connections

**Note:** TRS Orange Hose is not suction rated and cannot be used on the suction side of the cooling tower.

TRS provides piping kits to reduce the number of final connections at the tower to one inlet and one outlet connection per tower including suction rated hose on return side of tower. Water connection piping kits including parts, quantities, and installation order are listed below.

- Trane supplied suction hose is greater than 150 pounds per section.
- Trane trailer mounted hose trays are greater than 1000 pounds per tray.
- Refer to CHS-SVX01\*-EN for additional information on Victaulic Couplings

**⚠ WARNING**

**Heavy Object!**

Failure to follow instructions below could result in unit dropping which could result in death or serious injury, and equipment or property-only damage. Ensure that all the lifting equipment used is properly rated for the weight of the unit being lifted. Each of the cables (chains or slings), hooks, and shackles used to lift the unit must be capable of supporting the entire weight of the unit. Lifting cables (chains or slings) may not be of the same length. Adjust as necessary for even unit lift.

## 270 Ton Water Connections/ Piping Kit

CSCT0270F0 Piping Kit Contents	
Qty	Description
2	DN150-6 - 6 in.107N QuickVic Coupling
1	6 in. x 10 ft. Suction Hose

### CSCT0270F0 Style Towers

- One (1) 6-in. inlet
- One (1) 6-in. outlet grooved water connections

Figure 8. 270-ton cooling tower piping kit connection

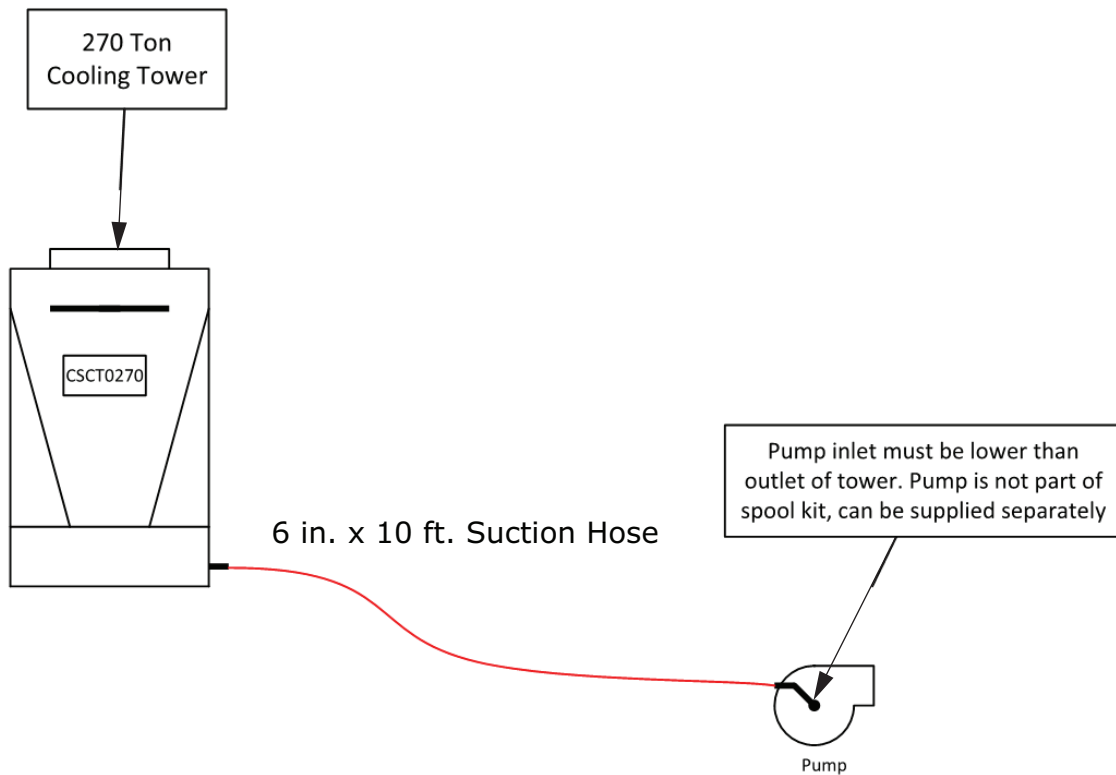



## Cooling Tower Piping Kit and Water Connections

### 500 Ton Water Connections/ Piping Kit

CSCT0500F1 Total Piping Kit Contents	
Qty	Description
2	6 in. x 68 3/4 in. Sch. 80 PVC Pipe
2	6 in. x 48 in. Sch. 80 PVC Pipe
1	6 in. x 28 in. Sch. 80 PVC Pipe
1	6 in. x 9 1/4 in. Sch. 80 PVC Pipe
3	8 in. x 10 ft. Suction Hose
3	DN150-6 - 6 in. No 11 90° Elbow
3	DN250-150 - 10 in. x 6 in. No 50. Concentric Reducer
2	DN150-6 – 6 in. Series 761 Vic 300 MasterSeal Butterfly Valve with Gear Operator
13	DN150-6 - 6 in. 107N QuickVic Coupling
1	DN200-8 8 in. No. 20 Tee
2	DN200-8 - 8 in. No 11 45° Elbow
8	DN200-8 - 8 in. 107N QuickVic Coupling
3	DN250-200 - 10 in. x 8 in. No 50. Concentric Reducer
1	DN250-10 10 in. No. 20 Tee
5	DN250-10 - 10 in. 107N QuickVic Coupling

CSCT0500F1 style towers have inlet/outlet piping kits to tie 6 inch inlet and 10 inch outlet grooved water connections together. See [Figure 9, p. 15](#).

#### Piping Kit Assembly

Do not tighten couplings until piping is fully assembled.

Follow all Victaulic assembly instructions including, torque specifications for couplings and lubricant for all gaskets. For more information refer to CHS-SVX01\*-EN.

#### 500 Ton Tower Supply Side Piping Assembly Instructions:

CSCT0500F1 Supply Side Piping Kit Contents	
Qty	Description
2	6 in. x 68 3/4 in. Sch. 80 PVC Pipe
2	6 in. x 48 in. Sch. 80 PVC Pipe
1	6 in. x 28 in. Sch. 80 PVC Pipe
1	6 in. x 9 1/4 in. Sch. 80 PVC Pipe
3	DN150-6 - 6 in. No 11 90° Elbow
3	DN250-150 - 10 in. x 6 in. No 50. Concentric Reducer
2	DN150-6 – 6 in. Series 761 Vic 300 MasterSeal Butterfly Valve with Gear Operator
13	DN150-6 - 6 in. 107N QuickVic Coupling
1	DN250-10 10 in. No. 20 Tee
3	DN250-10 - 10 in. 107N QuickVic Coupling

- At each tower inlet, attach DN150 – 6 inch 90° Elbow facing directly down using DN150 – 6 inch Victaulic Coupling.
- Attach 6 inch x 68 ¾ inch Sch. 80 PVC Pipe to each supply elbow using DN150 – 6 inch Victaulic Coupling.
- Attach DN150 – 6 inch Series 761 Butterfly Valve to each PVC Pipe using DN150 – 6 inch Victaulic Coupling.
- Attach 6 inch x 9 ¼ inch Sch. 80 PVC Pipe to tower rear supply butterfly valve using DN150 – 6 inch Victaulic Coupling.
- Support DN150 – 6 inch, 90° Elbow and attach to tower rear PVC Pipe facing the front of the tower, parallel with the trailer using DN150 – 6 inch Victaulic Coupling.
- Attach DN250-150 - 10 inch x 6 inch No 50. Concentric Reducer to tower front butterfly valve using DN150 – 6 inch Victaulic Coupling.
- Support DN250-10 10 inch No. 20 Tee and attach to 10 inch x 6 inch Concentric Reducer at the front tower supply connection using DN250 – 10 inch Victaulic Coupling.

**Note:** The top of the tee should connect with the tower front supply. See [Figure 9, p. 15](#).

- Attach DN250-150 – 10 inch x 6 inch No 50. Concentric Reducer to both sides of 10 inch Tee with DN250 – 10 inch Victaulic Couplings.
- Support piping and connect both supply connections together using two 6 inch x 48 inch and one 6 inch x 28 inch Sch. 80 PVC Pipe from front to rear supply tower connections.
- Tighten couplings.

#### 500 Ton Tower Return Side Piping Assembly Instructions:

CSCT0500F1 Return Side Piping Kit Contents	
Qty	Description
3	8 in. x 10 ft. Suction Hose
1	DN200-8 8 in. No. 20 Tee
2	DN200-8 - 8 in. No 11 45° Elbow
8	DN200-8 - 8 in. 107N QuickVic Coupling
3	DN250-200 - 10 in. x 8 in. No 50. Concentric Reducer
2	DN250-10 - 10 in. 107N QuickVic Coupling

- At each tower outlet, attach DN250-200 – 10 inch x 8 inch No 50. Concentric Reducer using DN250 – 10 inch Victaulic Couplings.
- At each tower outlet, attach one end of 8 inch x 10 foot Suction Hose using DN200 – 8 inch Victaulic Couplings. Hose weight may be greater than 150 pounds.

## Cooling Tower Piping Kit and Water Connections

### ⚠ CAUTION

#### Heavy Object!

Lifting this object manually may cause minor to moderate injury. Follow local standards or requirements for lifting heavy objects.

- Route each hose away from the tower outlets and towards each other in the middle of the trailer. See [Figure 10, p. 15](#)
- At the opposite end of each 8 inch x 10 foot Suction Hose(s), attach DN200-8 - 8 inch No 11 45° Elbow using DN200 – 8 inch Victaulic Couplings.

- Bring both 8 inch – 45° Elbows into DN200-8 8 inch No. 20 Tee and attach using DN200 – 8 inch Victaulic Couplings.
- For the remaining connection on 8 inch Tee, attach 8 inch x 10 foot Suction Hose using DN200 – 8 inch Victaulic Couplings.
- At the end of the 8 inch x 10 foot Suction Hose, attach DN250-200 - 10 inch x 8 inch No 50. Concentric Reducer using DN200 – 8 inch Victaulic Coupling.
- Tighten couplings.

Figure 9. 500-ton cooling tower piping kit connection(s)

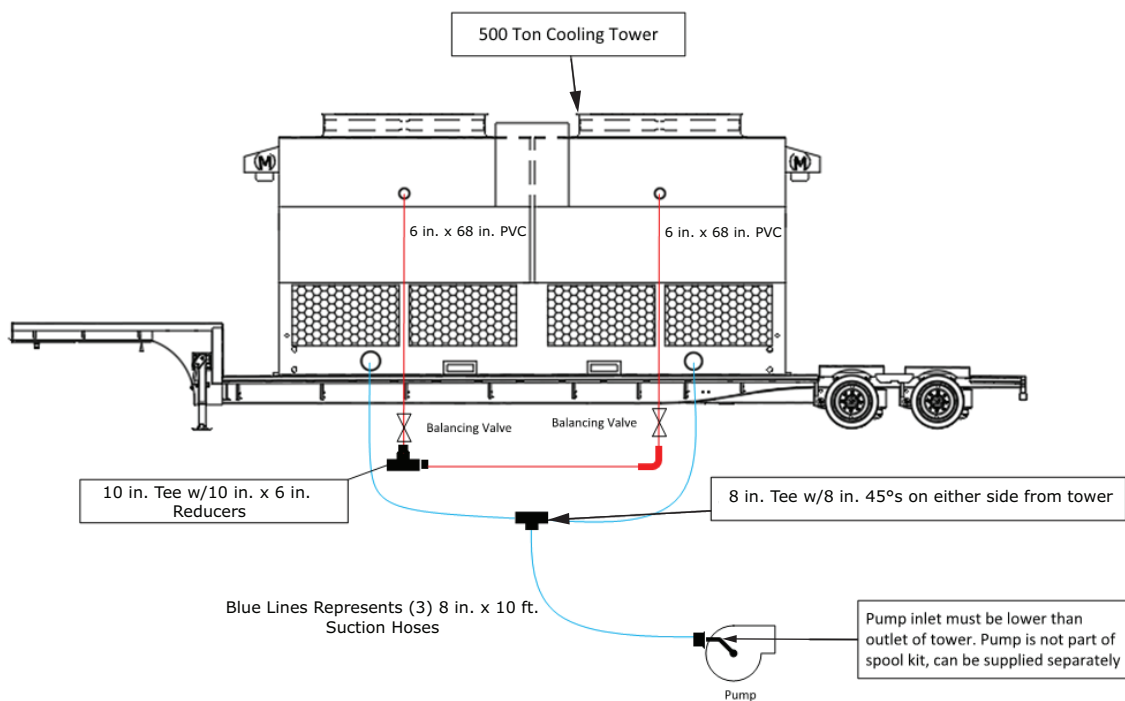

Figure 10. 500-ton cooling tower - assembled piping kit





## Cooling Tower Piping Kit and Water Connections

### 1000 Ton Water Connections/ Piping Kit

RSCT1000F2 Total Spool Kit Contents	
Qty	Description
30	DN200-8 - 8 in. 107N QuickVic Coupling
2	8 in. Dia x 12 in. Long Sch. 80 PVC Pipe(s)
3	8 in. Dia x ~88.5 in. Long Sch. 80 PVC Pipe(s)
1	8 in. Dia x 21 in. Long Sch. 80 PVC Pipe(s)
1	8 in. Dia x 24 in. Long Sch. 80 PVC Pipe(s)
1	8 in. Dia x ~36.5 in. Long Sch. 80 PVC Pipe(s)
1	8 in. Dia x ~45.5 in. Long Sch. 80 PVC Pipe(s)
10	DN250-10 - 10 in. 107N QuickVic Coupling
7	DN200-8 - 8 in. No 10 90° Elbow
2	DN200-8 - 8 in. No 11 45° Elbow
2	DN250-10 10 in. No. 20 Tee
2	DN200-8 - 8 in. No. 60 Cap
2	DN250-10 -10 in. No. 60 Cap
6	DN250-200 - 10 in. x 8 in. No 50. Concentric Reducer
2	DN200-8 - Series 761 Vic 300 MasterSeal Butterfly Valve with Lever Operator
4	8 in. x 8 ft. Suction Hose
1	10 in. x 8 ft. Suction Hose

RSCT1000F2 style towers have inlet/outlet piping kits to tie two 8 inch inlet and 10 inch outlet grooved water connections together. See [Figure 11, p. 18](#).

### Piping Kit Assembly

Do not tighten couplings until piping is fully assembled.

Follow all Victaulic assembly instructions including, torque specifications for couplings and lubricant for all gaskets. For more information refer to CHS-SVX01\*-EN.

#### **CAUTION**

#### **Heavy Object!**

**Lifting this object manually may cause minor to moderate injury. Follow local standards or requirements for lifting heavy objects.**

Trailer mounted hose trays must be removed via mechanical lift due to weight greater than 1000 pounds.

### 1000 Ton Tower Supply Side Piping Assembly Instructions:

RSCT1000F2 Supply Side Spool Kit Contents	
Qty	Description
14	DN200-8 - 8 in. 107N QuickVic Coupling
3	8 in. Dia x ~88.5 in. Long Sch. 80 PVC Pipe(s)
1	8 in. Dia x ~36.5 in. Long Sch. 80 PVC Pipe(s)
1	8 in. Dia x ~45.5 in. Long Sch. 80 PVC Pipe(s)
2	DN250-10 - 10 in. 107N QuickVic Coupling
3	DN200-8 - 8 in. No 10 90° Elbow
1	DN250-10 10 in. No. 20 Tee
2	DN200-8 - 8 in. No. 60 Cap
2	DN250-200 - 10 in. x 8 in. No 50. Concentric Reducer
2	DN200-8 - Series 761 Vic 300 MasterSeal Butterfly Valve with Lever Operator

**Note:** Tower piping kit designed such that only one side (driver or passenger) of tower will be used.

- Starting at the tower connection side that won't be used, attach DN200-8 – 8 inch No. 60 Caps using DN200 – 8 inch Victaulic Couplings.
- At each tower inlet, attach DN200-8 – 8 inch Series 761 Butterfly Valve using DN200 – 8 inch Victaulic Couplings.

**Note:** If connecting to passenger side of tower, Module 2 (front module) butterfly valve will need to be rotated 90° clockwise from the upright position in order to not interfere with electrical connections.

- Attach DN200-8 – 8 inch No. 10, 90° Elbow to each butterfly valve using DN200 – 8 inch Victaulic Couplings. Elbows should face the ground and be perpendicular to tower supply piping.
- Attach approximately 45.5 inch x 8 inch Sch. 80 PVC Pipe to module 2 (front module) elbow and approximately 36.5 inch x 8 inch Sch. 80 PVC Pipe to Module 1 (rear tower) using DN200 – 8 inch Victaulic Couplings.
- Support DN200-8 – 8 inch No. 10, 90° Elbow and attach to Module 2 (front module) PVC Pipe facing towards the rear of the trailer, parallel with the trailer using DN200 – 8 inch Victaulic Coupling.
- Attach two DN250-200 – 10 inch x 8 inch No 50. Concentric Reducer(s) to DN250-10 10 inch No. 20 Tee with one reducer on the top and one reducer on one side of the Tee DN250 – 10 inch Victaulic Coupling(s).
- Support DN250-10 10 inch No. 20 Tee with reducers attach to Module 1; 8 inch Sch. 80 PVC Supply Piping using DN200 – 8 inch Victaulic Coupling.

**Note:** Orient the Tee with the branch line facing up and connecting to Module 1 (rear module). See [Figure 12, p. 18](#)

- While properly supporting piping, connect both supply connections together using (3) 8 inch x 88.5 inch Sch. 80 PVC Pipe(s) from front to rear supply tower connections.



## Cooling Tower Piping Kit and Water Connections

9. Final assembly should resemble [Figure 12, p. 18](#).
10. Tighten couplings.

### 1000 Ton Tower Return Side Piping Assembly Instructions:

RSCT1000F2 Return Side Spool Kit Contents	
Qty	Description
16	DN200-8 - 8 in. 107N QuickVic Coupling
2	8 in. Dia x ~88.5 in. Long Sch. 80 PVC Pipe(s)
1	8 in. Dia x ~36.5 in. Long Sch. 80 PVC Pipe(s)
1	8 in. Dia x ~45.5 in. Long Sch. 80 PVC Pipe(s)
8	DN250-10 - 10 in. 107N QuickVic Coupling
4	DN200-8 - 8 in. No 10 90° Elbow
2	DN200-8 - 8 in. No 11 45° Elbow
1	DN250-10 10 in. No. 20 Tee
2	DN250-10 -10 in. No. 60 Cap
4	DN250-200 - 10 in. x 8 in. No 50. Concentric Reducer
4	8 in. x 8 ft. Suction Hose
1	10 in. x 8 ft. Suction Hose

1. At tower connection side that won't be used, attach DN250-10 – 10 inch No. 60 Caps using DN250 – 10 inch Victaulic Couplings.
2. At each tower outlet, attach DN250-200 – 10 inch x 8 inch No 50. Concentric Reducer using DN250 – 10 inch Victaulic Couplings.
3. At each tower outlet, attach 8 inch x 12 inch Sch. 80 PVC Pipe(s) using DN200 – 8 inch Victaulic Couplings.
4. To relieve undue stress on cooling tower basin connections, support each 8 inch x 12 inch Sch. 80 PVC Pipes with pipe jack stands underneath the front of the trailer in the spare tire carrier area.
5. Attach DN200-8 – 8 inch No. 10, 90° Elbow(s) to each 8 inch Sch. 80 PVC Pipe using DN200 – 8 inch Victaulic Couplings. Elbows should face the ground and be perpendicular to tower return piping.
6. Attach approximately 24 inch x 8 inch Sch. 80 PVC pipe to Module 2 (front module) elbow and approximately 21 inch x 8 inch Sch. 80 PVC to Module 1 (rear module) elbow using DN200 – 8 inch Victaulic Couplings.
7. Support DN200-8 – 8 inch No. 10, 90° Elbow(s) and attach to each 8 inch Sch. 80 PVC Pipe installed in previous step using DN200 – 8 inch Victaulic Couplings. Orient elbows to face away from trailer and towards each other. See [Figure 13, p. 18](#).
8. Attach two pieces (8 inch x 8 foot suction hose) to each installed elbow and bring the opposite end of the hoses together in the middle per [Figure 11, p. 18](#).
9. Place DN250-10 10 inch No. 20 Tee in between each outlet connection of tower and close to the hoses routed in previous step.
10. Assemble DN250-200 - 10 inch x 8 inch No 50. Concentric Reducer(s) on either side of the pass through on the tee.
11. Attach DN200-8 - 8 inch No 11 45° Elbow(s) to each reducer.
12. Fasten with DN200 – 8 inch Victaulic Couplings.
 

**Note:** 45° Elbow orientation should be set pointing towards each hose.
13. Attach each outlet hose to the 45° Elbow/Tee assembly using DN200 – 8 inch Victaulic Couplings.
14. At top of tee, attach 10 inch x 8 foot suction hose using DN250 – 10 inch Victaulic Coupling and route to pump inlet.
15. Tighten couplings.

## Cooling Tower Piping Kit and Water Connections

---

Figure 11. 1000-ton cooling tower piping kit assembly

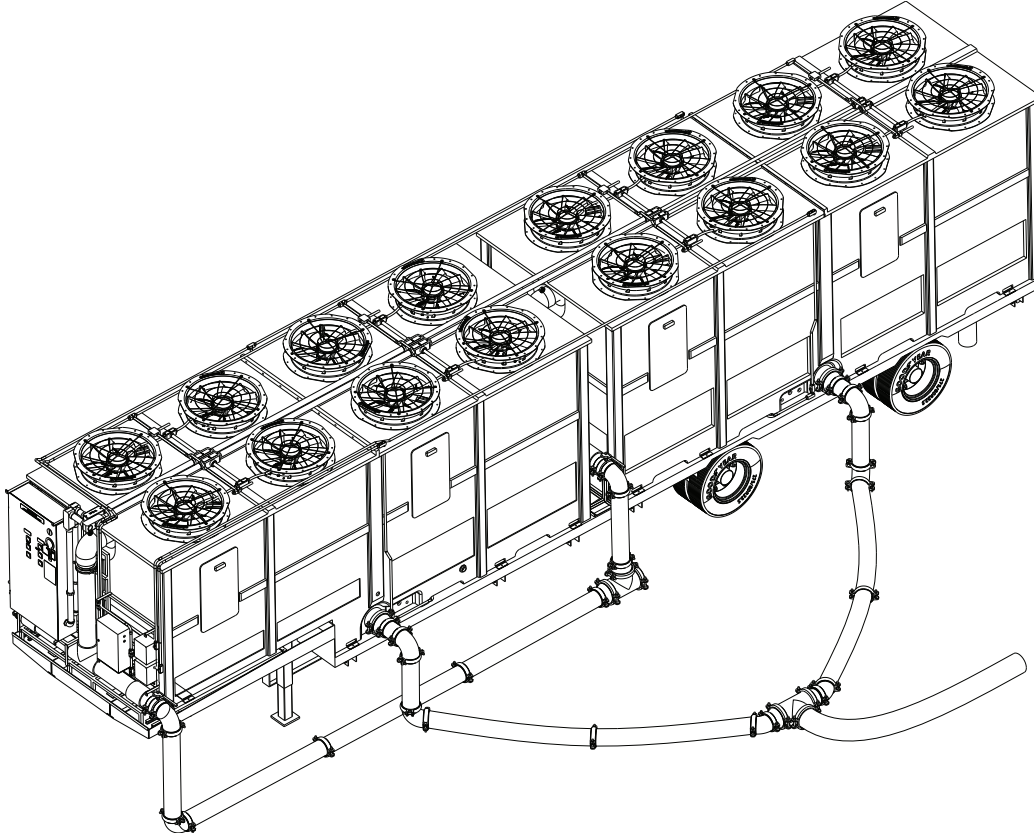

Figure 12. 1000-ton tower - assembled supply side drop piping



Figure 13. 1000-ton on tower - assembled suction side drop down





# Start-Up

## 270 Ton Tower (CSCT0270F0) Startup

1. Confirm 460V three phase power is connected via Series 16 Type Cams and the phase rotation is correct.
2. Confirm tower is level, refer to [Table 2, p. 6](#) for level requirements.
3. Flush the cold water basin (with strainer screens in place) to remove sediment or dirt that may have settled during transportation.
4. Install water piping, remove basin access, adjust make up water valve to correct level.

### Notes:

- Basin outlet connections must be fully submerged for tower to operate properly.
  - A bleed line and valve should be installed on pump discharge piping. Route line to appropriate drain.
  - Tower drain plug has been removed to avoid water pooling inside the tower basin. Drain plug is located inside the starter cabinet. Reinstall drain plug prior to starting tower if port is not to be used.
5. Fill the loop and confirm (while water is flowing through the system), the water in the basin stays above tower basin connections.

**Note:** Refer to [Table 1, p. 5](#) for make-up water operating pressures.

If operation ambient temperatures below 45°F while cooling tower is on site, basin heater switch (located on starter panel) should be in “AUTO” position.

If ambient temperatures above 45°F while cooling tower is on site, basin heater switch should be placed in the “OFF” position.

Heater must be fully submerged below water to operate properly.

**Figure 14. 270-ton cooling tower basin heater switch**



6. Confirm 460V three phase power is connected via Series 16 Type Cams and phase rotation is correct.

7. Confirm all access openings, safety screens and covers are in place and secure.
8. To start the cooling tower, flip disconnect to the “ON” position.

**Important:** Prior to starting fan(s), water must be flowing through the system.

This tower is equipped with an HOA Switch located on the starter panel.

Turn the switch to “HAND” mode to run the fan 24/7.

Turn the switch to “AUTO” mode to run the fan until the basin water setpoint has been reached.

**Figure 15. 270-ton cooling tower fan switch**



If running the tower in auto, select a supply water setpoint via the temperature control mounted directly to the tower next to the 6 inch water connections. The cooling tower fan will cycle on/off as the basin water temperature exceeds or meets the dial setpoint.

**Figure 16. 270-ton cooling tower temperature control**



9. Confirm proper rotation of fan and allow sufficient time for unit to reach steady state prior to leaving unit to operate autonomously.

## 500 Ton Tower (CSCT0500F1) Startup

1. Confirm tower is level, refer to [Table 2, p. 6](#) for level requirements.  
**Note:** *This tower has two cells. Each cell can operate at individual setpoints if required.*
2. If tower cells are to be run in parallel with each other and both cells are feeding the same process, confirm weir plate between tower basins is removed. If tower cells are to be run on independent water circuits, confirm weir plate has been installed between cells.
3. Flush the cold water basin (with strainer screens in place) to remove sediment or dirt that may have settled during transportation.
4. Install water piping, remove tower louvers, adjust make up water valve(s) to correct level

**Notes:**

- *Basin outlet connections must be fully submerged for tower to operate properly.*
  - *A bleed line and valve should be installed on pump discharge piping. Route line to appropriate drain.*
  - *Tower drain plug has been removed to avoid water pooling inside the tower basin. Drain plugs are located inside the starter cabinet. Reinstall drain plug prior to starting tower if ports are not to be used.*
5. Fill the loop and confirm (while water is flowing through the system), the water in the basin stays above tower basin connections.

**Note:** Refer to [Table 1, p. 5](#) for make-up water operating pressures.

If operation ambient temperatures below 45°F while cooling tower is on site, basin heater switches (located on starter panel) should be in “AUTO” position.

If ambient temperatures above 45°F while cooling tower is on site, basin heater switch should be placed in the “OFF” position.

Heater must be fully submerged below water to operate properly.

**Figure 17. 500-ton cooling tower basin heater switches**



6. Confirm 460V three phase power is connected via Series 16 Type Cams and phase rotation is correct.
7. Confirm all access openings, safety screens and covers are in place and secure.
8. To start the cooling tower, turn disconnect to the “ON” position.

**Important:** *Prior to starting fan(s), water must be flowing through the system.*

This tower is equipped with individual HOA Switches for each tower module on the starter panel.

Turn the switch to “HAND” mode to run the fan 24/7.

Turn the switch to “AUTO” mode to run the fan until the basin water setpoint has been reached.

**Figure 18. 500-ton cooling tower fan switch**



### **⚠ WARNING**

#### **Live Electrical Components!**

**Failure to follow all electrical safety precautions when exposed to live electrical components could result in death or serious injury.**

**When it is necessary to work with live electrical components, have a qualified licensed electrician or other individual who has been properly trained in handling live electrical components perform these tasks.**

If running the tower in auto, use the Honeywell T775 Controller to select a supply water setpoint via the Honeywell Controller mounted on the inside of the starter panel. The cooling tower fan(s) will cycle on/off as the basin water temperature exceeds or meets the T775 Controller setpoint. Please refer to [Figure 20, p. 21](#) for programming setpoint. To access the cooling setpoint, press Menu → Program → Relay 1 → SETPOINT → Up or Down

Arrows to change SETPOINT → Press right arrow (→) to accept the setpoint Temperature.

**Note:** Relay 1 changes setpoint for cell 1 of cooling tower and Relay 2 changes setpoint for cell 2 of cooling tower.

**Figure 19. 500-ton cooling tower temperature control**



**Figure 20. 500-ton setpoint navigation**

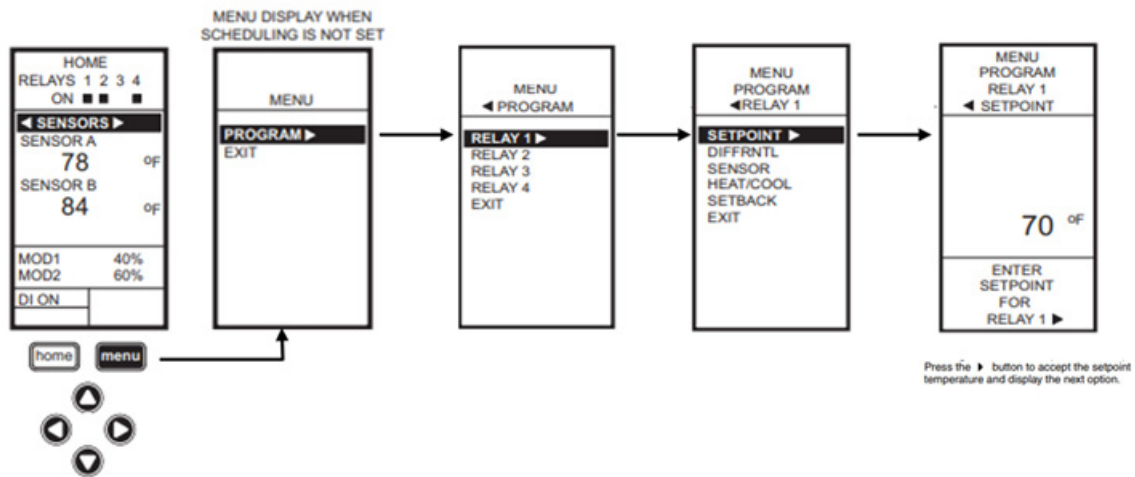

9. Confirm proper rotation of fan and allow sufficient time for unit to reach steady state prior to leaving unit to operate autonomously.

# 1000 Ton Tower (RSCT1000F2) Startup

1. Confirm tower is level, refer to [Table 2, p. 6](#) for level requirements.
 

**Note:** This tower has 2 cells and the ability to operate each cell at individual setpoints if required.
2. If tower cells are to be run in parallel with each other and both cells are feeding the same process, confirm equalization valve between tower basins is open. If tower cells are to be run on independent water circuits, equalization valve between tower basins is closed.
3. Flush the cold water basin (with strainer screens in place) to remove sediment or dirt that may have settled during transportation.
4. Install water piping, remove tower louvers, adjust make up water valve(s) to correct level.

**Notes:**

- Basin outlet connections must be fully submerged for tower to operate properly.
  - A bleed line and valve should be installed on pump discharge piping. Route line to appropriate drain.
  - Tower drain plug has been removed to avoid water pooling inside the tower basin. Drain plugs are located inside the starter control cabinet. Reinstall drain plugs prior to starting tower if ports are not to be used.
5. Fill the loop and confirm (while water is flowing through the system), the water in the basin stays above tower basin connections.

**Note:** Refer to [Table 1, p. 5](#) for make-up water operating pressures.

If operation ambient temperatures below 45°F while cooling tower is on site, basin heater breakers (located inside of the starter panel) should be in “ON” position. If ambient temperatures are going to be above 45°F while cooling tower is on site, basin heater breakers should be placed in the “OFF” position.

Figure 21. 1000-ton cooling tower basin heater breakers



6. Confirm 460V three phase power is connected via Series 16 Type Cams and phase rotation is correct.
7. Confirm all access openings, safety screens and covers are in place and secure.
8. To start the cooling tower, turn disconnect (Represented as letter I in [Figure 22, p. 22](#)) to the “ON” position.

**Important:** Prior to starting fan(s), water must be flowing through the system.

This tower is equipped with individual Start and Stop Buttons for each tower module on the starter panel. Selection of M1(J1) and M2(J2) “Start” button(s) will enable the temperature controller assigned to the respective module to control the fans.

Figure 22. 1000-ton cooling tower starter panel door layout

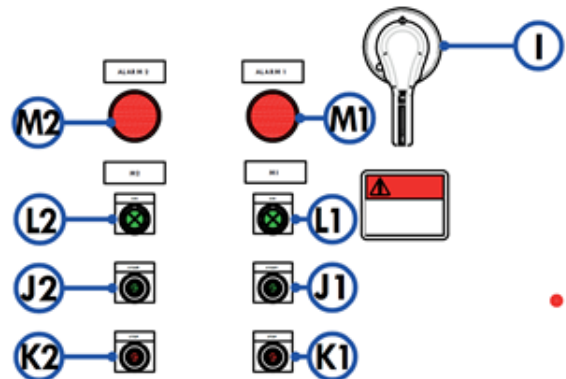

The control module(s) are in a separate cabinet that is mounted on the end of the cooling tower, next to the starter cabinet at eye level.

**Figure 23. 1000-ton cooling tower control module**



- Once the control module(s) are powered up, see one of the two screens in [Figure 24, p. 23](#). To toggle between the “Info” screen and the “Main Menu” screen, press **▼ + ▲** simultaneously on the control module.

**Figure 24. 1000-ton cooling tower control module startup screens**

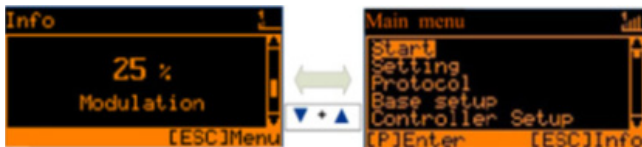

- The tower control module(s) control each tower individually, so the setpoint will need to be changed on both control module(s) in order to maintain setpoint.
- To change the setpoint, navigate to the “Main Menu” → Setting → SETPOINT 1 from this menu, press the “P” Key and the “SETPOINT 1” value is begin to flash. Using the **▼ + ▲** keys, adjust the setpoint to the desired value and press the “P” key to save.

**Note:** *If prompted for a passcode use 0010 to enter the setting screen.*

- To exit to main menu, press **▼ + ▲** keys. The tower fans will modulate accordingly to reject the heat load and maintain cold water temperature.
- Confirm proper rotation of fan(s) and allow sufficient time for unit to reach steady state prior to leaving unit to operate autonomously.

For additional information, refer Reymisa Cooling Tower IOM that ships with machine or contact Trane Rental services for copy.



# Maintenance

- Ensure proper chemical water treatment and bleed all of the air out of the system. See the water treatment recommendations below.
- Before beginning any maintenance, be certain that the power is turned off and the tower is properly locked and tagged out.
- Inspect the basin strainer and clean weekly or as often as necessary to keep it clean.
- Check the float and float valve periodically to make sure the water level is correct in the basin. The water level can be checked during operation by opening the removable louver section at the valve while the pump is running and the fans are off.
- Inspect the air louvers periodically to remove any paper, leaves, or other debris that may be blocking airflow into the unit.

## Water Treatment Recommendations

To avoid build-up of residuals in the water distribution system, water must be bled off from the system in an amount equal to the rate of evaporation. In addition, water quality should be checked to ensure that the chemistry is balanced and that the water system is free from biological contamination.

It is recommended the system has a bleed line installed on the discharge side of the system pump and should include a metering connection and valve. The metering connection should be used to determine the bleed water volume. The valve is used to regulate the flow. As a guideline, the bleed line and valve should be large enough to allow bleed off of an amount of water equal to 3 US gpm for each 100 tons cooling or use the formula  $\text{Bleed (gpm)} = \text{Flow (gpm)} \times \text{Range (F)} / 1,000$ . Confirm with your water treatment specialist to confirm the required bleed off for your system.

In some cases, the make-up water will be so high in mineral content that a normal bleed-off will not prevent scaling. Water treatment will be required and qualified water treatment company familiar with the local water conditions should be consulted. Any water treatment system used in the unit must be compatible with the unit's materials of construction. If a chemical water treatment system is used, the chemicals selected must be accurately metered and concentrations properly controlled. See [Table 4](#) for recommended levels.

**Table 4. Water chemistry guidelines**

Parameter	Range
pH	6.5 to 8.0
Hardness as CaCO <sub>3</sub>	50 to 300 ppm
Alkalinity as CaCO <sub>3</sub>	50 to 300 ppm
Chlorides as Cl	125 ppm max
TDS (Total Dissolved Solids)	1500 ppm max
Silica - SiO <sub>4</sub>	180 ppm max
Sulfates - SO <sub>4</sub>	250 ppm max
Phosphates - PO <sub>2</sub>	15 ppm max

- Soft water systems should be avoided.
- The use of acid should be avoided.
- CAUTION - Never batch load chemicals into unit.
- Always regulate chemical feed.

## Control of Biological Contamination

Water quality should be checked regularly for biological contamination. If biological contamination is detected, a more aggressive water treatment and mechanical cleaning program is required. The water treatment program should be performed in conjunction with a qualified water treatment company. It is important that all internal surfaces be clean of accumulated dirt and sludge.

To minimize the risk of biological contamination prior to start-up or after an extended shut down, it is recommended that the entire system (cooling tower, system piping, heat exchanger, etc.) be properly cleaned. Clean all debris such as leaves and dirt from the basin. Completely fill the basin to the overflow level with water. Initiate a biocide water treatment or shock treatment program prior to operating the unit. It is preferable that all such procedures be conducted and supervised by your water treatment specialist.

**⚠ CAUTION**

**Personal Protective Equipment (PPE) Required!**

Failure to follow all safety instructions below could result in minor to moderate injury. **ALWAYS** wear Personal Protective Equipment (PPE) including goggles or face shield, chemical resistant gloves, boots, apron or suit as required. If it becomes necessary to use cleaning agent, refer to the manufacturer's Materials Safety Data Sheet and follow all recommended safe handling practices.

## Air Contamination

If the unit is located in an industrial area where there are chemical fumes or particulate matter in the air the impurities



will be washed out in the recirculated water and may cause scaling or corrosion. It is important not to locate the unit next to a smokestack because the unit will draw in these fumes and severely corrosive conditions may result. Bleed-off will help the situation, but if there is any sign of corrosion or scaling, a qualified water treatment company should be contacted.



# 270 Ton Cooling Tower

**Table 5. General - CSCT0270F0**

Labels	Value
Nominal Cooling Tons	270 <sup>(a)</sup>
Number of Electrical Circuits	1
Number of Cells	1
Number of Fans/Cell	1

(a) Nominal cooling tower tons are determined at 3 GPM/ton, 85/95 across tower at 78°F wet bulb temperature.

**Table 6. Electrical data – non-fused disconnect**

Labels	Value
Voltage	460V 3-phase
Frequency	60 Hz
Wire Connection Type	Series 16 Cam-Type Connection Only
SCCR	5000 A
Minimum Circuit Ampacity (MCA)	75.8 A
Maximum Overcurrent Protection (MOP)	150 A
Basin Heater Qty/FLA	(1) 10.8 A
Fan Motor Qty/FLA	(1) 52.0 A

**Table 7. Mechanical data**

Labels	Value
Inlet Connection Qty/Size/Type	(1) 6 in. Victaulic
Outlet Connection Qty/Size/Type	(1) 6 in. Victaulic
Make-up Connection Qty/Size/Type	(1) 2 in. MPT
Drain Connection Qty/Size/Type	(1) 2 in. FPT
Overflow Connection Qty/Size/Type	(1) 3 in. FPT
Drive Type	Belt Drive
Maximum Inlet Water Temp	130°F
Installed Clearances	4 ft. (sides), 6 ft. (ends)

## Features

- Minimal setup required for quick installation/start-up
- Forced draft counterflow
- Complete controls package included
- Galvanized steel construction
- Capable of being lifted and transported by forklift
- One (1) 9kW basin heaters



**Table 8. Dimensions and weights**

Labels	Value
Length	20 ft.
Width	8 ft.
Height	8 ft. 2 in.
Shipping Weight	6,500 lbs
Operating Weight	10,700 lbs
Fork Pocket Center to Center Distance	3.75 in. x 9.75 in.
Fork Pocket Dimensions	63 in.

**Note:** Lifting device: Forklift or crane

**Note:** Sound Data – Available Upon Request

**Table 9. Cooling tower capacity (GPM)**

Water Temperature		Wet Bulb Temperature (°F)						
In (°F)	Out (°F)	66	68	70	72	75	78	80
95	85	1348	1274	1196	1113	975	816	694
103	85	1017	968	915	858	763	653	567
105	85	973	927	877	824	735	631	549
120	90	1007	972	936	897	832	760	706
130	90	910	880	848	813	756	692	644

## Dimensional Drawings

**Figure 25. 270-ton unit drawing**

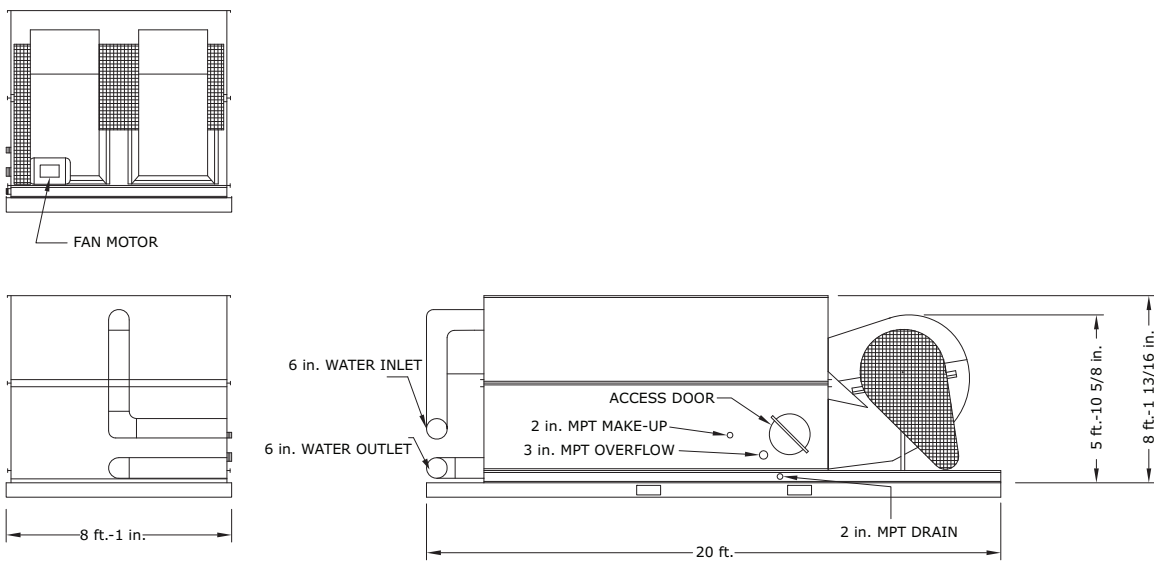



# 500 Ton Cooling Tower

**Table 10. General - CSCT0500F1**

Labels	Value
Nominal Cooling Tons	500 <sup>(a)</sup>
Number of Electrical Circuits	1
Number of Cells	2
Number of Fans/Cell	2

(a) Nominal cooling tower tons are determined at 3 GPM/Ton, 85/95 across tower at 78°F wet bulb temperature.

**Table 11. Electrical data – non-fused disconnect**

Labels	Value
Voltage	460V 3-phase
Frequency	60 Hz
Wire Connection Type	Series 16 Cam-Type Connection Only
SCCR	5kAIC
Minimum Circuit Ampacity (MCA)	76.5 A
Maximum Overcurrent Protection (MOP)	100 A
Basin Heater Qty/FLA	(2) 7.2 A
Fan Motor Qty/FLA	(2) 34.0 A

**Table 12. Mechanical data**

Labels	Value
Inlet Connection Qty/Size/Type	(2) 6 in. Victaulic
Outlet Connection Qty/Size/Type	(2) 10 in. Victaulic
Make-up Connection Qty/Size/Type	(2) 2 in. MPT
Drain Connection Qty/Size/Type	(2) 3 in. FPT
Overflow Connection Qty/Size/Type	(2) 3 in. FPT
Drive Type	Belt Drive
Maximum Inlet Water Temp	130°F
Installed Clearances	12 ft. (sides), 4 ft. (ends)

## Features

- Minimal setup required for quick installation/start-up
- Series 16 cam-type connections
- Complete controls package included
- Galvanized steel construction
- Two (2) 6kW basin heaters
- Thermostatic staging of fans with manual bypass
- Weir gate for independent cell operation

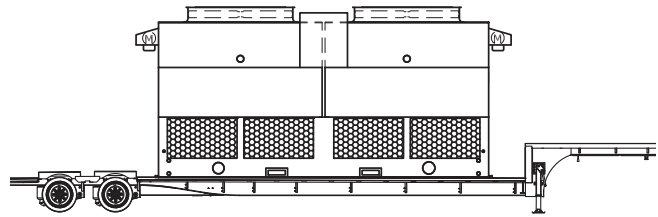

**Note:** This drawing is a representation only and actual delivered product may vary.

**Table 13. Dimensions and weights**

Labels	Value
Length	48 ft.
Width	8 ft. 6 in.
Height	13 ft. 6 in.
Shipping Weight w/ Trailer	24,960 lbs
Operating Weight w/ Trailer	32,580 lbs
Trailer Weight	~15,000 lbs

**Note:** Lifting device: Forklift or crane

**Note:** Sound data – Available upon request.

**Table 14. Cooling tower capacity (GPM)**

Water Temperature		Wet Bulb Temperature (°F)						
In (°F)	Out (°F)	66	68	70	72	75	78	80
95	85	2605	2453	2320	2154	1848	1500	1212
103	85	1862	1772	1675	1537	1326	1086	895
105	85	1756	1667	1571	1458	1246	1027	840
120	90	1747	1705	1653	1592	1471	1305	1192
130	90	1575	1535	1475	1407	1292	1134	1028

## Dimensional Drawings

**Figure 26. 500-ton unit drawing**

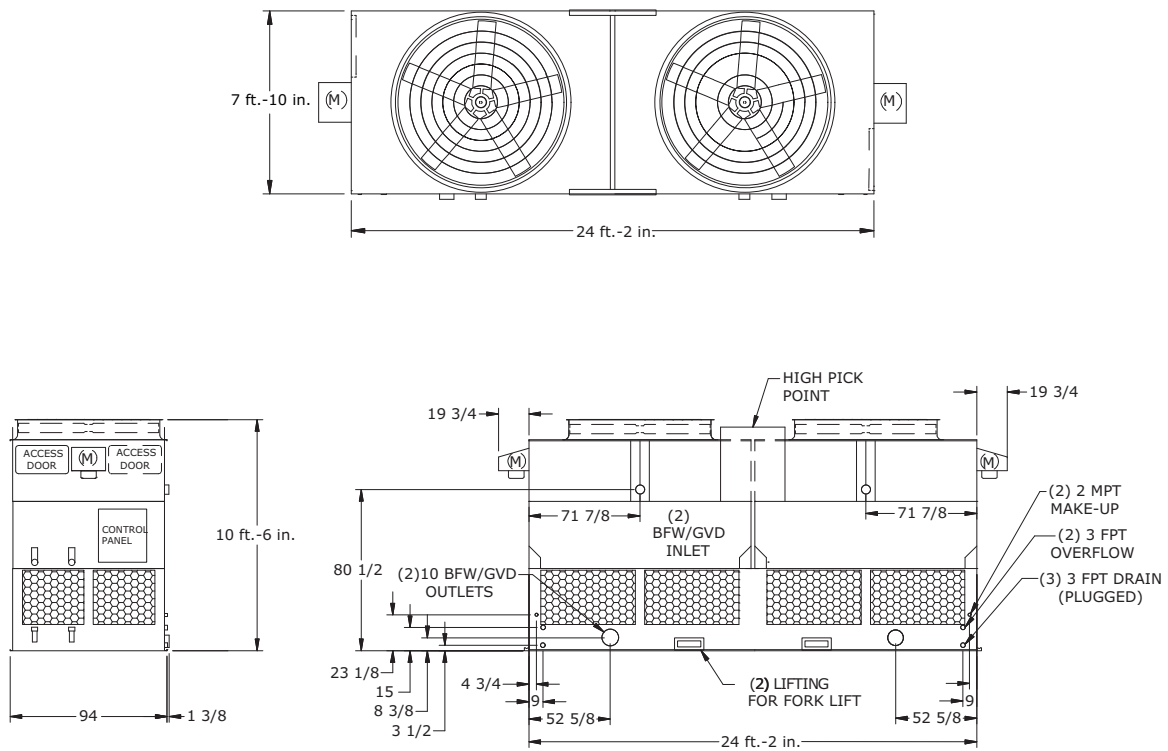



# 1000 Ton Cooling Tower

**Table 15. General - RSCT1000F2**

Labels	Value
Nominal Cooling Tons	1000 <sup>(a)</sup>
Number of Electrical Circuits	1
Number of Cells	2
Number of Fans/Cell	8

(a) Nominal cooling tower tons are determined at 3 GPM/ton, 85/95 across tower at 78°F wet bulb temperature.

**Table 16. Electrical data – circuit breaker style disconnect (300 Amp)**

Labels	Value
Voltage	460V 3-phase
Frequency	60 Hz
Wire Connection Type	Series 16 Cam-Type Connection Only
SCCR	65,000 A
Minimum Circuit Ampacity (MCA)	180 A
Maximum Overcurrent Protection (MOP)	300 A
Basin Heater Qty/FLA	(4) 9.63 A Each
Fan Motor Qty/FLA	(16) 4.7 A Each

**Table 17. Mechanical data**

Labels	Value
Inlet Connection Qty/Size/Type	(2) 8 in. Victaulic
Outlet Connection Qty/Size/Type	(2) 10 in. Victaulic
Make-up Connection Qty/Size/Type	(2) 1½ in. FPT
Drain Connection Qty/Size/Type	(2) 2 in. FPT
Overflow Connection Qty/Size/Type	(2) 2 in. FPT
Drive Type	Direct Drive EC Fan
Maximum Inlet Water Temp	130°F

## Features

- Minimal setup required for quick installation/start-up
- Induced draft counterflow
- Complete controls package included
- EC fan motors for capacity modulation
- Reinforced fiberglass construction with permanently bonded UV protection
- Seamless cold water basin
- Water connections on both sides of tower
- Two (2) 8 kW basin heaters
- Cells can run independently of each other or together
- Mechanical float make up water valve

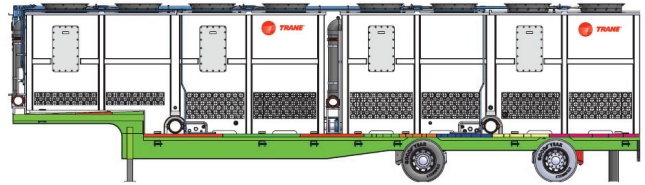

**Table 18. Dimensions and weights**

Labels	Value
Length	48 ft. 4 in.
Width	8 ft. 6 in.
Height	13 ft. 6 in.
Shipping Weight w/ Trailer	30,000 lbs
Operating Weight w/ Trailer	54,600 lbs
Trailer Weight	10,100 lbs

**Note:** Lifting device: None – not removable from trailer

**Table 19. Installed clearances<sup>(a)</sup>**

Labels	Value
Front/Back	6 ft.
Sides	5 ft.

(a) Clearances assume three walls surround tower with one open end. See IOM for additional clearances while operating multiple towers in close proximity of each other.

**Table 20. Sound data**

Labels	Value
Free-Field S.P.L at 5 ft	75.9 dBA
Free-Field S.P.L at 30 ft	60.3 dBA
Free-Field S.P.L at 50 ft	55.9 dBA

**Table 21. Cooling tower capacity (GPM)**

Water Temperature		Wet Bulb Temperature (°F)						
In (°F)	Out (°F)	66	68	70	72	75	78	80
95	85	-	-	4599	4237	3650	3000	2481
103	85	3679	3483	3274	3052	2687	2273	1955
105	85	3735	348	3302	3110	2904	2566	2180
120	90	3884	3699	3566	3426	3276	3031	2756
130	90	3341	3229	3110	2982	2771	2553	2354

## Dimensional Drawings

**Figure 27. 1000-ton unit drawing**

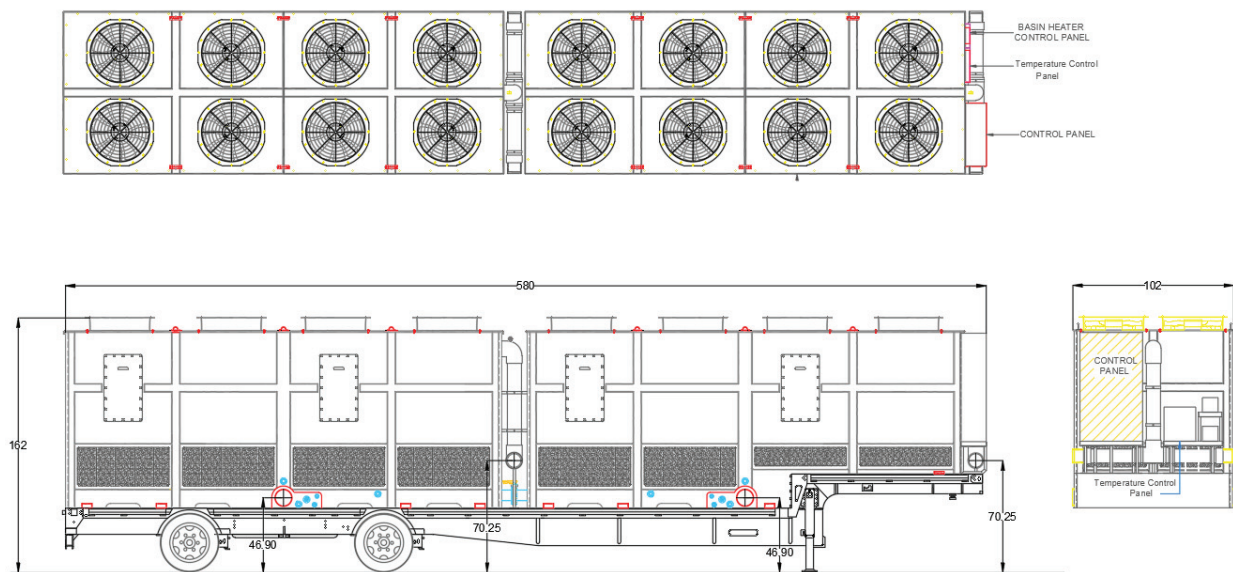

Trane - by Trane Technologies (NYSE: TT), a global climate innovator - creates comfortable, energy efficient indoor environments for commercial and residential applications. For more information, please visit [trane.com](http://trane.com) or [tranetechnologies.com](http://tranetechnologies.com).

Trane has a policy of continuous product and product data improvement and reserves the right to change design and specifications without notice. We are committed to using environmentally conscious print practices.