



Installation, Operation, and Maintenance

TruSense™ Refrigerant Monitor



Model: RMWH

⚠ SAFETY WARNING

Only qualified personnel should install and service the equipment. The installation, starting up, and servicing of heating, ventilating, and air-conditioning equipment can be hazardous and requires specific knowledge and training. Improperly installed, adjusted or altered equipment by an unqualified person could result in death or serious injury. When working on the equipment, observe all precautions in the literature and on the tags, stickers, and labels that are attached to the equipment.

September 2025

PART-SVX008A-EN

TRANE
TECHNOLOGIES™



Introduction

Read this manual thoroughly before operating or servicing this unit.

Warnings, Cautions, and Notices

Safety advisories appear throughout this manual as required. Your personal safety and the proper operation of this machine depend upon the strict observance of these precautions.

The three types of advisories are defined as follows:



Indicates a potentially hazardous situation which, if not avoided, could result in death or serious injury.



Indicates a potentially hazardous situation which, if not avoided, could result in minor or moderate injury. It could also be used to alert against unsafe practices.



Indicates a situation that could result in equipment or property-damage only accidents.

Important Environmental Concerns

Scientific research has shown that certain man-made chemicals can affect the earth's naturally occurring stratospheric ozone layer when released to the atmosphere. In particular, several of the identified chemicals that may affect the ozone layer are refrigerants that contain Chlorine, Fluorine and Carbon (CFCs) and those containing Hydrogen, Chlorine, Fluorine and Carbon (HCFCs). Not all refrigerants containing these compounds have the same potential impact to the environment. Trane advocates the responsible handling of all refrigerants.

Important Responsible Refrigerant Practices

Trane believes that responsible refrigerant practices are important to the environment, our customers, and the air conditioning industry. All technicians who handle refrigerants must be certified according to local rules. For the USA, the Federal Clean Air Act (Section 608) sets forth the requirements for handling, reclaiming, recovering and recycling of certain refrigerants and the equipment that is used in these service procedures. In addition, some states or municipalities may have additional requirements that must also be adhered to for responsible management of refrigerants. Know the applicable laws and follow them.

⚠ WARNING

Proper Field Wiring and Grounding Required!

Failure to follow code could result in death or serious injury.

All field wiring **MUST** be performed by qualified personnel. Improperly installed and grounded field wiring poses **FIRE** and **ELECTROCUTION** hazards. To avoid these hazards, you **MUST** follow requirements for field wiring installation and grounding as described in **NEC** and your local/state/national electrical codes.

⚠ WARNING

Personal Protective Equipment (PPE) Required!

Failure to wear proper PPE for the job being undertaken could result in death or serious injury.

Technicians, in order to protect themselves from potential electrical, mechanical, and chemical hazards, **MUST** follow precautions in this manual and on the tags, stickers, and labels, as well as the instructions below:

- **Before installing/servicing this unit, technicians MUST put on all PPE required for the work being undertaken (Examples; cut resistant gloves/sleeves, butyl gloves, safety glasses, hard hat/bump cap, fall protection, electrical PPE and arc flash clothing). ALWAYS refer to appropriate Safety Data Sheets (SDS) and OSHA guidelines for proper PPE.**
- **When working with or around hazardous chemicals, ALWAYS refer to the appropriate SDS and OSHA/GHS (Global Harmonized System of Classification and Labelling of Chemicals) guidelines for information on allowable personal exposure levels, proper respiratory protection and handling instructions.**
- **If there is a risk of energized electrical contact, arc, or flash, technicians MUST put on all PPE in accordance with OSHA, NFPA 70E, or other country-specific requirements for arc flash protection, PRIOR to servicing the unit. NEVER PERFORM ANY SWITCHING, DISCONNECTING, OR VOLTAGE TESTING WITHOUT PROPER ELECTRICAL PPE AND ARC FLASH CLOTHING. ENSURE ELECTRICAL METERS AND EQUIPMENT ARE PROPERLY RATED FOR INTENDED VOLTAGE.**

⚠ WARNING**Follow EHS Policies!**

Failure to follow instructions below could result in death or serious injury.

- All Trane personnel must follow the company's Environmental, Health and Safety (EHS) policies when performing work such as hot work, electrical, fall protection, lockout/tagout, refrigerant handling, etc. Where local regulations are more stringent than these policies, those regulations supersede these policies.
- Non-Trane personnel should always follow local regulations.

⚠ WARNING**Cancer and Reproductive Harm!**

This product can expose you to chemicals including lead and bisphenol A (BPA), which are known to the State of California to cause cancer and birth defects or other reproductive harm. For more information go to www.P65Warnings.ca.gov.

Copyright

This document and the information in it are the property of Trane, and may not be used or reproduced in whole or in part without written permission. Trane reserves the right to revise this publication at any time, and to make changes to its content without obligation to notify any person of such revision or change.

Trademarks

All trademarks referenced in this document are the trademarks of their respective owners.

Revision History

This literature supersedes with RMWH-SVX001D-EN.



Table of Contents

General Information	6	Span Gas Calibration	25
Description	7	Unsuccessful Calibrations	27
Identifying Your Unit	7	Routine Operation	28
Visible Alarming Devices	9	Dashboard Overview	28
Touchscreen Display	9	Point Details	28
Strobe	9	Point Hold	28
Audible Alarming Devices	9	Automatic Point Hold	28
Internal Horn	9	Manual Point Hold	28
Optional External Horn	9	Predictive Warnings	29
Optional External Alarm Activation and		Cautions, Warnings, and Alarms	29
Silencing Stations	9	Non-Latching Events	30
Communications	9	Latching Events	30
Digital Communication	9	Faults	30
Analog Communication	10	Noncritical Faults	31
Installation	11	Critical Faults	31
Receiving, Unpacking, and Inspecting	11	Event Log	31
Mounting Guidelines	11	All	32
Sample and Exhaust Lines	12	Alarms	32
Tubing Material	12	Faults	32
Routing and Placement	12	Calibration	33
End-of-Line Filters	13	Edit Settings	33
Connections	13	Preferences	33
Exhaust Venting	13	Gas Configuration	34
Wiring and Grounding	13	Point Configuration	35
Electrical Power Supply Requirements	15	Relay Configuration	37
Relay Outputs	15	Communications Output	37
Initial Setup	16	About	38
Language/Date and Time/Password	16	Diagnostics	39
Point Configuration	17	Flow Diagnostics	39
Gas Configuration	18	Sensor Performance	40
Relay Configuration	20	Pump Performance	41
Communications Output	21	Errors	42
Calibration	23	Maintenance	43
Initial Setup	23	Scheduled Maintenance	43
Routine Operation	24	Examine and Replace End-of-Line	
Starting Calibration	24	Filters	43
Stopping Calibration	24	Examine and Replace Internal Inline	
Zero Gas Calibration	25	Filters	43
		Replace Fuses	44
		Cleaning	46

Touchscreen Display	46	Alarm Setpoints	54
Enclosure	46	Relays	54
Technical Data	47	Output	54
Technical Specifications/Equipment		Appendix D: MODBUS Holding	
Ratings	47	Registers	55
Gas Reading Accuracy	47	TruSense RMWH Refrigerant Monitor—	
Troubleshooting Guidelines	48	MODBUS RTU (Holding Registers)	55
Ordering Information	49	RESET Button Actions	57
Replacement Parts	49	Unit Status Flags	57
Appendix A: Start-up Check List	51	Channel Status Flags	58
Appendix B: Installation of Optional		Gas Types	58
Equipment	52	Appendix E: BACnet Objects	59
Strobe	52	TruSense RMWH Refrigerant Monitor—	
External Horn	52	BACnet	59
External Alarm Activation Station	53	RESET Button Actions	61
External Alarm Silencing Station	53	Unit Status Flags	61
Appendix C: Default Settings	54	Channel Status Flags	62
		Gas Types	62



General Information

The TruSense™ RMWH Refrigerant Monitor, hereafter also referred to as “the device”, is a gas monitor intended for indoor use in mechanical equipment rooms or commercial spaces where refrigerant equipment, such as centrifugal chillers, is used. The device is specified to support compliance with federal, state, and local safety codes that govern emissions.

Note: For any maintenance procedure provided in this manual, use only genuine Trane replacement parts. Repair or alteration of the TruSense™ RMWH Refrigerant Monitor system beyond the scope of these maintenance instructions or by anyone other than authorized Trane service personnel can cause incorrect operation of the device. For a list of approved parts and how to order them, see “Ordering Information,” p. 49.

⚠ WARNING

Explosion Hazard!

Failure to follow instruction below could result in death or serious injury.

Do NOT install in areas that contain a flammable mixture of gas and air.

⚠ WARNING

Safety Alert!

Failure to follow instructions in this manual could result in death or serious injury.

Make sure the device is installed in a clean, dry area that is protected from vibration, including but not limited to a chiller, and heat sources.

Do not paint the device. Do not paint near any of the sample line inlets. If painting is done near the device, make sure that paint is not deposited on the sample inlet fittings. Paint deposits can prevent correct operation of the device.

Make sure the sample inlet lines to the device are clean and non-condensing.

Avoid any installation where condensation can collect. Condensation can clog or block sample lines, which will prevent the device from receiving new or fresh gas samples in the area being monitored.

Install and maintain end-of-line filters in all sample inlet lines. See “End-of-Line Filters,” p. 13.

The only absolute method of ensuring correct overall operation of a gas detection instrument is to do a check with a known concentration of the gas for which it has been calibrated. Do a calibration check as part of the installation and initial setup. See “Initial Setup,” p. 23. Do routine calibration checks thereafter. See “Routine Operation,” p. 24.

Install a circuit breaker for the incoming power connections of the device. Put the circuit breaker in a location that is easy to access and near the device. Clearly mark the circuit breaker as the disconnecting unit for the device.

Properly vent the exhaust of the TruSense™ RMWH Refrigerant Monitor system to a safe area. Improper venting of the exhaust can cause serious personal injury or death. See “Exhaust Venting,” p. 13.

To prevent unauthorized or untrained personnel from opening the device enclosure, install a locking mechanism through the metal loop on either latch on the left side of the device (see Figure 2, p. 7)

Perform periodic leak tests on all sample lines.

Do not exceed the relay contact rating listed in “Technical Specifications/Equipment Ratings,” p. 47. Otherwise relay operation could fail.

NOTICE

Equipment Damage!

Failure to follow instruction below could result in equipment damage.

The device is intended for indoor use only. Do not use the device for outdoor applications.



Description

The TruSense™ RMWH Refrigerant Monitor provides continuous monitoring of refrigerant gas levels for up to 16 points in nonhazardous areas. With the ability to read down to 1 ppm, the device provides a response to a refrigerant leak, supporting the safety of personnel and the environment, and equipment efficiency. The device uses patented Photoacoustic Infrared technology to allow the accurate measurement of refrigerant gases with minimum interference from other vapors. The device monitors refrigerant gases up to 1000 ppm with an ability to maintain a gas list through an internal refrigerant library.

The TruSense RMWH Refrigerant Monitor minimizes unnecessary maintenance costs associated with calibration and sensors by utilizing a centralized sample draw system. The device is factory calibrated for six specific refrigerants, with the flexibility to adjust the gas of interest in the field.

The device offers three levels of alarm — caution, warning, and alarm — that are all configurable through the intuitive

touchscreen display. Fault and service notifications provide alerts when servicing is necessary. Audible and visual indications such as horns and strobes provide alerts about refrigerant leaks.

Digital communications can be transmitted using the Modbus remote terminal unit (RTU) or BACnet™ multidrop serial bus/token passing (MS/TP) protocol. Analog communications can be transmitted using a 4 to 20 mA or 0 to 10 Vdc current loop.

The TruSense™ RMWH Refrigerant Monitor requires minimal maintenance and incorporates predictive diagnostics that continuously check key detector components to ensure proper operation. When the device is installed, operated, and maintained according to Trane's recommendations, it provides reliable protection and long-term stability.

Identifying Your Unit

Figure 1. Front of device

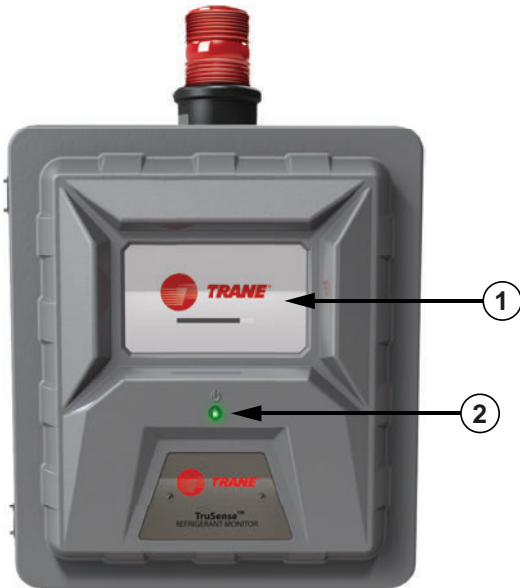

Item	Description
1	7-in. resistive touchscreen user interface
2	Power indicator

Figure 2. Back of device

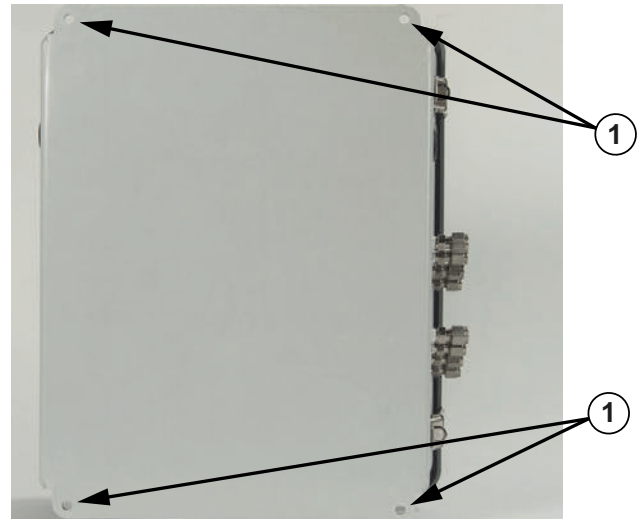

Item	Description
1	Mounting locations (10 in. x 14-5/8 in.)

Figure 3. Right side of device

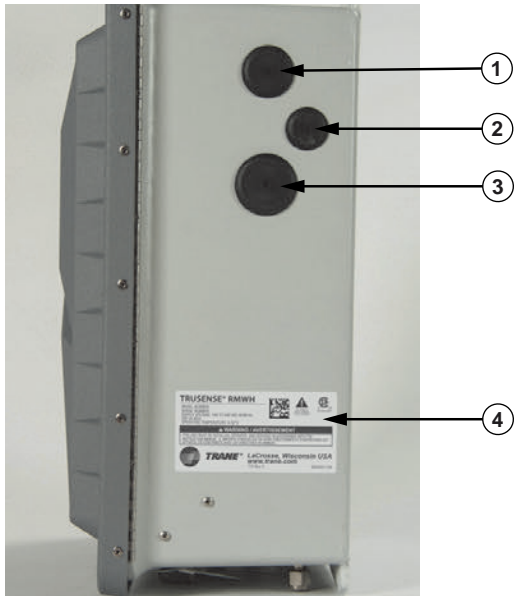

Item	Description
1	AC power wiring cutout
2	Protective earth grounding cutout (optional)
3	Relay wiring cutout
4	Approval and unit identification label

Figure 4. Left side of device

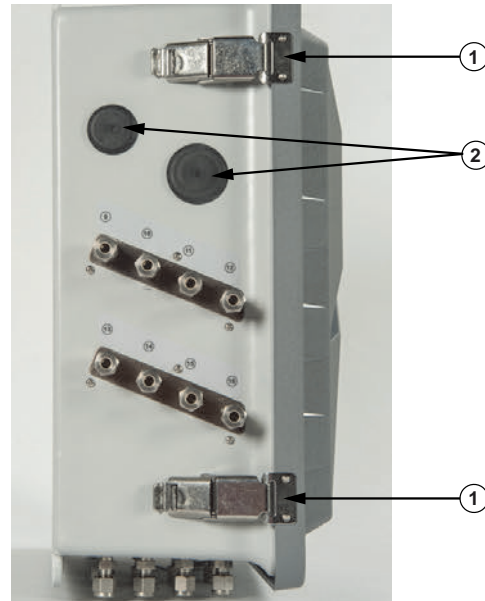

Item	Description
1	Latches (lockable with padlock)
2	Signal wiring cutouts

Figure 5. Bottom of device

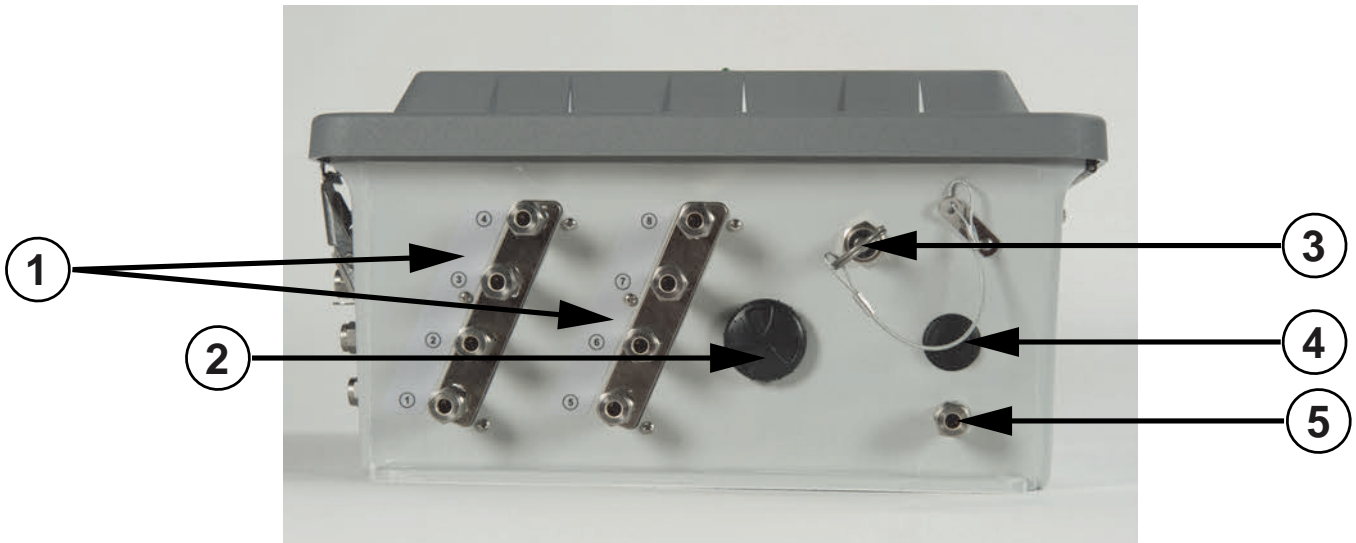

Item	Description
1	Sample line identification labels
2	Internal alarm sounder
3	Calibration port

Item	Description
4	IP rated vent
5	Exhaust port (do not block)

Figure 6. Internal touchpoints

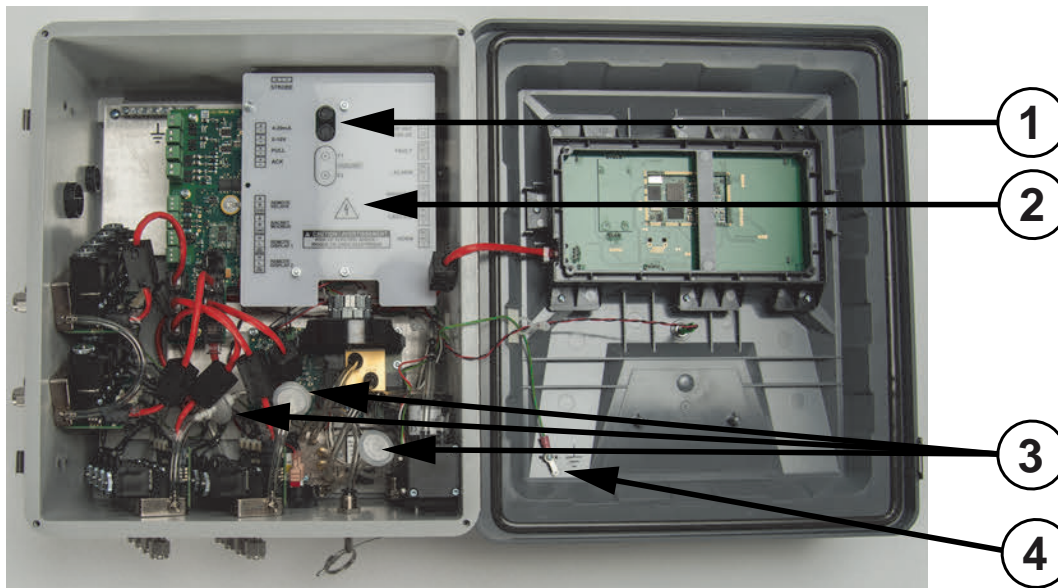

Item	Description
1	Fuses
2	AC wiring cover
3	Internal filters
4	ESD tie-off location

Optional External Horn

An optional external horn can be mounted in a location away from the device to provide an audible indicator of a gas leak.

For a list of approved parts and how to order them, see [“Ordering Information,” p. 49.](#)

For installation instructions, see [“Appendix B: Installation of Optional Equipment,” p. 52.](#)

Visible Alarming Devices

The device provides visible alarm indicators through the touchscreen display and strobe.

Touchscreen Display

After the initial setup configuration, the touchscreen display shows a dashboard with the main function buttons and tiles for the points that are enabled.

Notifications for all predictive warnings, alarms, and faults show on the dashboard.

Strobe

The strobe provides a user-configurable visual indication of a gas leak.

Audible Alarming Devices

The device provides audible alarm indicators through the internal alarm and optional external horn.

Internal Horn

A horn inside the device provides an audible indicator of a gas leak. The level of sound output from the internal horn is adjustable. To adjust the level of sound output, turn the sounder clockwise or counterclockwise.

Optional External Alarm Activation and Silencing Stations

The device supports optional external stations for the activation and silencing of audible alarms.

Normally closed alarm activation and silencing switches can be wired in a single loop with a total maximum loop length of 2500 ft. (762 m).

For a list of approved parts and how to order them, see [“Ordering Information,” p. 49.](#)

For installation instructions, see [“Appendix B: Installation of Optional Equipment,” p. 52.](#)

Communications

The device has both digital and analog outputs for use with external controllers or building management systems.

Digital Communication

The device is capable of MODBUS® RTU or BACnet® MS/TP outputs. For setup instructions, see [“Communications Output,” p. 21.](#)



Description

For a list of the registers that are available for exchange with the MODBUS controller, see “Appendix D: MODBUS Holding Registers,” p. 55.

For a list of the BACnet Objects that are available for exchange with the BACnet controller, see “Appendix E: BACnet Objects,” p. 59.

Analog Communication

The device is capable of the following types of analog outputs:

- 4 to 20 mA, isolated, current sourcing
- 0 to 10 Vdc for gas sample point identification

Full scale is 1000 ppm.

Normal gas readings are at 4 to 20 mA. The reading is proportional to the detected gas concentration.

For the factory default of 100 percent full scale setting (0.016 mA = 1 ppm), see the following table.

Table 1. Scale analog output: 4 to 20 mA

Output (mA)	Gas Concentration (ppm)
4	0
5	63
6	125
7	188
8	250
9	313
10	375
11	438
12	500
13	563
14	625
15	688
16	750
17	813
18	875
19	937
20	1000

Table 2. Analog output settings

Warm-up	<ul style="list-style-type: none"> • Default = 3.5 mA • User adjustable between 0 and 3.75 mA
Calibration (non-configurable)	<ul style="list-style-type: none"> • 3.0 mA
Fault	<ul style="list-style-type: none"> • Default = 2.0 mA • User adjustable between 0.5 and 3.75 mA
Device over range (non-configurable)	21 mA

The voltage output can be used to identify any active gas sample line.

Table 3. 0 to 10 Vdc

Sample Line	Vdc	
	4 or 8 pt system	16 pt system
1	1	1.0
2	2	1.5
3	3	2.0
4	4	2.5
5	5	3.0
6	6	3.5
7	7	4.0
8	8	4.5
9	—	5.0
10	—	5.5
11	—	6.0
12	—	6.5
13	—	7.0
14	—	7.5
15	—	8.0
16	—	8.5

While the device is in calibration mode, the output is 10 Vdc.



Installation

⚠ WARNING

Hazardous Voltage!

Failure to disconnect power before servicing could result in death or serious injury.

Disconnect all electric power, including remote disconnects before servicing. Follow proper lockout/tagout procedures to ensure the power cannot be inadvertently energized. Verify that no power is present with a voltmeter. To prevent electrical shock, confirm the circuit board cover is in place prior to powering unit.

⚠ WARNING

Proper Field Wiring and Grounding Required!

Failure to follow code could result in death or serious injury.

All field wiring **MUST** be performed by qualified personnel. Improperly installed and grounded field wiring poses **FIRE** and **ELECTROCUTION** hazards. To avoid these hazards, you **MUST** follow requirements for field wiring installation and grounding as described in **NEC** and your local/state/national electrical codes.

Receiving, Unpacking, and Inspecting

1. Upon receipt of the device, inspect the shipping container for signs of damage. Report any damage to the carrier and record the information on the delivery receipt.
2. Carefully remove the device from its shipping container to avoid causing damage to sensitive electrical components. If damage has occurred, file the appropriate claim with the shipping carrier immediately.
3. Review all contents of the shipping container to make sure all of the following components are included:
 - a. Device
 - b. Instruction manual CD
 - c. End-of-line filters (quantity determined by number of ports ordered)
 - d. Remote horn (if equipped)
 - e. Protective foam
4. Notify Trane of any shortages immediately.
5. Keep the original packaging in case it is necessary to return the device for service.
6. Release the two latches on the left side of the device.
7. Open the enclosure.

8. Carefully inspect the internal components and assemblies for damage or shortages. If damage has occurred, file the appropriate claim with the shipping carrier immediately.
9. Before installation and use, keep the device in a dry, secure place in the original shipping container.

Mounting Guidelines

⚠ WARNING

Explosion Hazard!

Failure to follow instruction below could result in death or serious injury.

Do NOT install in areas that contain a flammable mixture of gas and air.

Do not mount the device directly to chiller, piping, or piping supports.

Mount the device:

- In a location that is easy to access and visible to personnel before they go into the area being monitored.
- To a rigid surface that does not have vibration or mechanical shock.
- In a vertical position.
- Approximately 5 ft. (1.5 m) above the ground (see [Figure 7, p. 12](#) and [Figure 8, p. 12](#)).
- With at least 3-inch. (7.62 cm) of clearance around all sides for proper ventilation, calibration, and servicing. Make sure there is adequate space to connect the external wiring and sample line piping (see [Figure 8, p. 12](#)).
- With the appropriate hardware. Make sure the hardware is suitable for the mounting surface and can withstand 70 lb (9 kg) without loosening or causing damage to the hardware or mounting surface. Use all four mounting holes provided on the device (see [Figure 9, p. 12](#)).
- Away from exposure to direct solar heating and other excessive heat sources.
- Away from wet or damp conditions.
- Away from areas that are dirty or exposed to oils or chemicals.

Figure 7. Mounting location

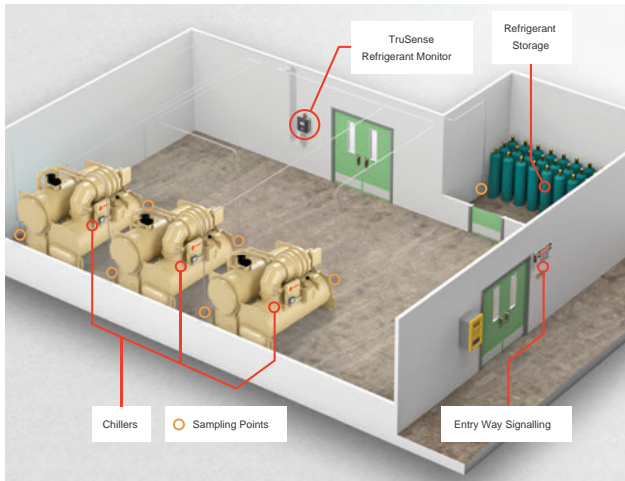

Figure 8. Front of device

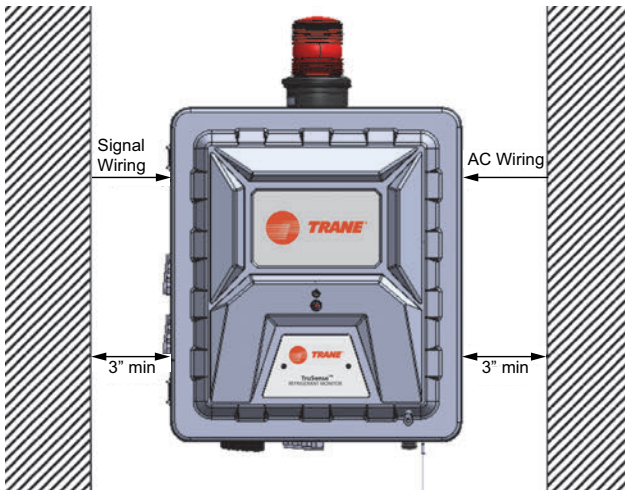
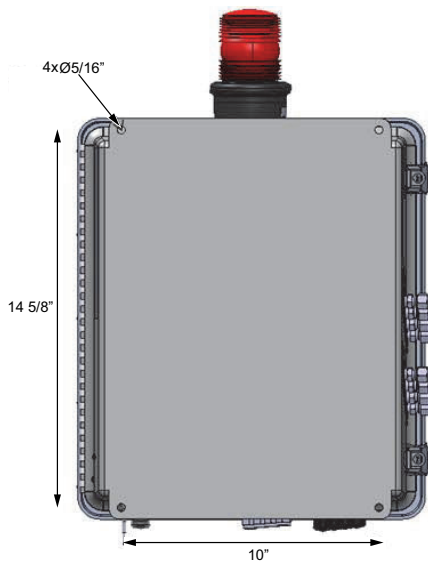

Figure 9. Rear of device



Sample and Exhaust Lines

Tubing Material

The device can use hard and soft tubing. The following are acceptable tubing types:

Imperial (I-P) Units
1/4-in. OD x 1/8-in. inside diameter (ID) Polyurethane tubing (ether-based)
1/4-in. OD x 3/16 1/4-in. ID Polyurethane tubing (ether-based)
1/4-in. OD Copper tubing
1/4-in. OD Stainless steel tubing

International System (SI) Units
6-mm OD x 4-mm ID Polyurethane tubing (ether-based)
6-mm OD Copper tubing
6-mm OD Stainless steel tubing

Note: Use the appropriate tools to give a clean, smooth end to the tubing when it is cut.

Routing and Placement

Trane recommends the use of at least two gas-monitoring points per chiller for sufficient detection monitoring. Due to installation and application variations, each system must be analyzed individually.

Do a smoke test of the mechanical room to determine the flow pattern and allow for optimal placement of the sample lines. For a list of approved parts and how to order them, see "Ordering Information," p. 49.

Keep the total line length of a point, including the sample line and exhaust line, at less than 1200 ft. (366 m). Keep lines as short as possible to minimize the transport time of the device.

Table 4. Transport time

Line Length (ft.)	4 pts	8 pts	16 pts
0	19 s	19 s	19 s
50	19 s	19 s	19 s
100	19 s	19 s	19 s
150	19 s	19 s	19 s
200	19 s	19 s	19 s
250	19 s	19 s	19 s
300	1 m 35 s	2 m 51 s	5 m 23 s
350	1 m 35 s	2 m 51 s	5 m 23 s
400	2 m 51 s	5 m 23 s	10 m 27 s
450	2 m 51 s	5 m 23 s	10 m 27 s
500	2 m 51 s	5 m 23 s	10 m 27 s

Note: Transport time is similar for all tubing configurations.

Note: Transport time is similar for all tubing configurations.

Typically, refrigerants collect near the floor. Install the sample points 12 to 18-inch (30 to 46 cm) above the floor.

For installations where water condensation in the sample lines is likely, Trane recommends installing a water trap filter such as a Parker P/N F504-01AHX67 or equivalent.

End-of-Line Filters

⚠ WARNING

Risk of Asphyxiation!

Failure to follow instruction below could cause inaccurate readings and improper gas monitoring which could result in death or serious injury. Install and properly maintain end-of-line filters.

Install an end-of-line filter (Trane P/N FLR04743) in each sample line to decrease contaminants in the sample lines and device.

Figure 10. End-of-line filter



Do the following procedure to install end-of-line filters:

1. Remove the new end-of-line filter from the bag.
2. Slide the end of the end-of-line filter with flexible tubing onto the sample line tubing. Make sure the arrow on the body of the filter (see Figure 10, p. 13) points in the direction of air flow into the sample line.

Examine and replace the end-of-line filters at regular intervals. The appropriate interval for replacement is determined by the environment of the installation.

For a list of approved parts and how to order them, see "Ordering Information," p. 49.

Connections

⚠ WARNING

Risk of Asphyxiation!

Failure to follow instructions below could cause inaccurate readings and improper gas monitoring which could result in death or serious injury.

- Install tubing with bend radii sufficient to prevent kinking or pinching.
- Prior to installation, clean tubing with compressed air or nitrogen to remove debris.

The device has Swagelok® compression fittings for connections to the sample and exhaust lines. These fittings

accept the hard and soft tubing specified in "Tubing Material," p. 12.

Do the following procedure to connect the sample and exhaust lines:

1. Remove the cap from the compression fitting.
2. Insert the tubing fully into the compression fitting and against the shoulder.
3. Turn the nut until it is finger-tight on the tubing.
4. Mark the nut at the 6 o'clock position.
5. While holding the body of the fitting steady, tighten the nut 1-1/4 turns to the 9 o'clock position.

Exhaust Venting

⚠ WARNING

Risk of Asphyxiation!

Failure to follow instruction below could cause inaccurate readings and improper gas monitoring which could result in death or serious injury. Remove cap from exhaust port prior to device operation.

The use of exhaust tubing reduces pump noise from the device.

Make sure to vent the exhaust of the device to the outside atmosphere (preferred) or a safe area.

Do not use inline or end-of-line filters in the exhaust line.

If possible, route the exhaust line so venting occurs to the outside atmosphere. Make sure to protect the end of the exhaust tube from elements such as water, dirt, snow, ice, and insects, which can cause clogs and prevent efficient venting.

If exhaust venting occurs indoors, make sure to route the exhaust line to:

- An area that is not monitored for refrigerant gases
- An area away from personnel

Wiring and Grounding

⚠ WARNING

Proper Ground Connection Required!

Failure to follow instructions below could result in death or serious injury.

Connect the device chassis to the earth ground at the ground bar.

Notes:

- Installations that require conformity to the CE mark must have a connection between the TruSense™ RMWH Refrigerant Monitor device and a nearby earth ground potential.
- To achieve this connection, install a 10 AWG or larger copper wire between the grounding lug

terminal strip on the right side of the TruSense RMWH Refrigerant Monitor device and the grounding point (protective earth). The wire length cannot be longer than 6 ft. (2 m).

The TruSense RMWH Refrigerant Monitor Wiring Diagram (Figure 11, p. 14) gives the details of the wiring requirements for the device.

Figure 11. TruSense™ RMWH refrigerant monitor wiring diagram

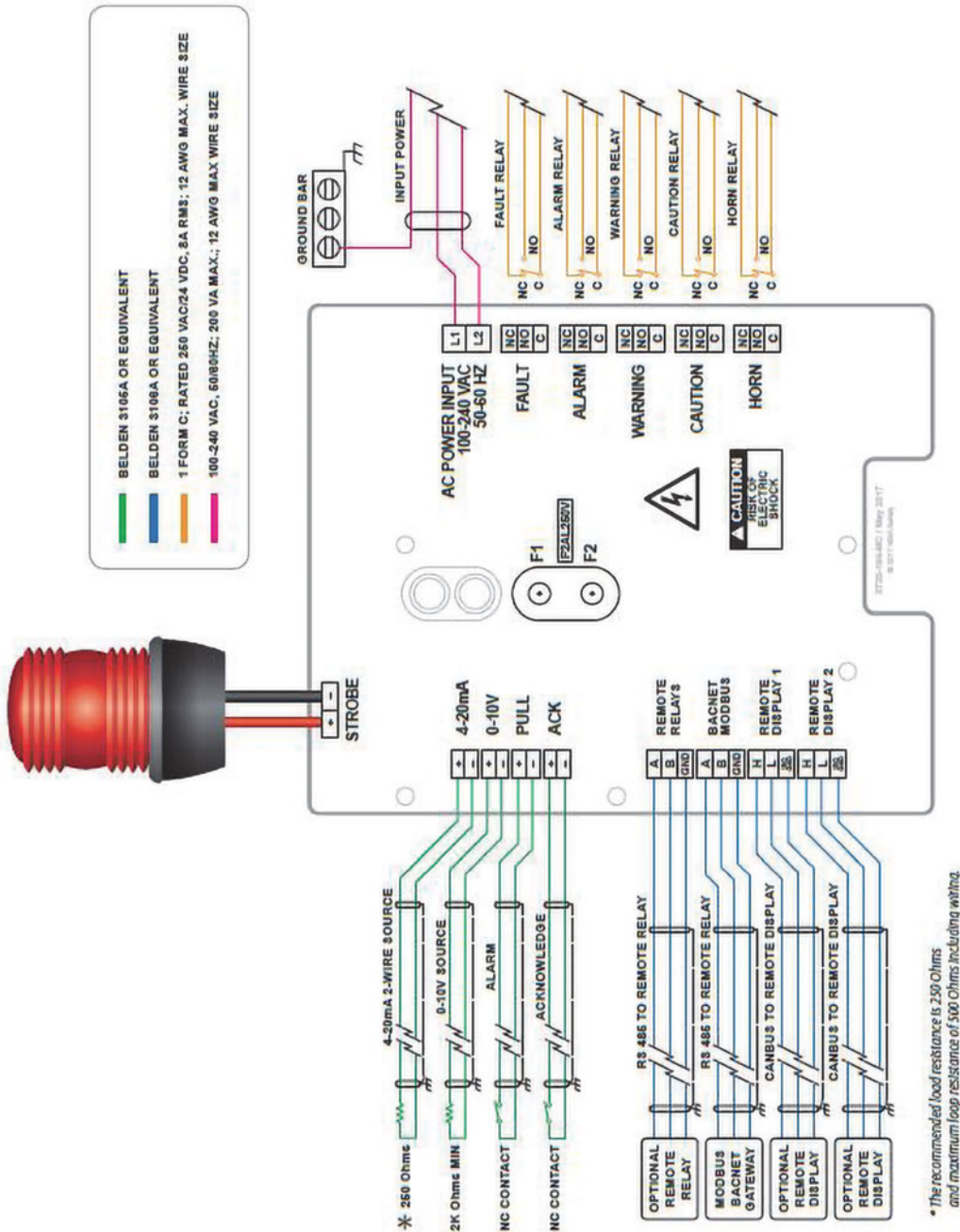

Electrical Power Supply Requirements

⚠ WARNING

Hazardous Voltage!

Failure to disconnect power before servicing could result in death or serious injury.

Disconnect all electric power, including remote disconnects before servicing. Follow proper lockout/tagout procedures to ensure the power cannot be inadvertently energized. Verify that no power is present with a voltmeter. To prevent electrical shock, confirm the circuit board cover is in place prior to powering unit.

⚠ WARNING

Proper Field Wiring and Grounding Required!

Failure to follow code could result in death or serious injury.

All field wiring **MUST** be performed by qualified personnel. Improperly installed and grounded field wiring poses **FIRE** and **ELECTROCUTION** hazards. To avoid these hazards, you **MUST** follow requirements for field wiring installation and grounding as described in **NEC** and your local/state/national electrical codes.

NOTICE

Electrostatic Discharge!

Electrostatic discharge can short equipment circuitry. Ensure that you are properly grounded before handling sensitive electronic equipment.

The device uses a power supply that accepts inputs of 100 to 240 Vac, 50/60 Hz, 200 VA maximum.

Make sure the device is connected directly to the ac power source through a dedicated circuit breaker.

Use an approved three-conductor wire (minimum 16 AWG), rated 300 Vac at 221°F (105°C), to complete the ac power connection.

Use only conduit hubs and hardware that are suitable for fiberglass enclosures.

Do the following procedure to connect electrical power:

1. Disconnect electrical power.
2. Install a circuit breaker for the incoming power connections of the device.
 - a. Put the circuit breaker in a location that is near the device and easy to access.
 - b. Clearly mark the circuit breaker as the disconnecting unit for the device.
3. If applicable, remove the locking mechanism.
4. Release the two latches on the left side of the device.
5. Open the enclosure.
6. Attach the ESD wrist strap to the ESD connection point inside the enclosure.
7. Use a 1/4-inch hex driver to remove the four hex nuts on the circuit board cover.
8. Remove the circuit board cover.
9. Remove the ac power wiring hole plug.
10. Install conduit hubs that are suitable for fiberglass enclosures through the ac power wiring hole plug openings.
11. Put the AC power wiring through the conduit.
12. Connect the ac power wiring to the L1 (HOT) and L2 (NEUTRAL) input terminals. Make sure the connectors are seated securely.
13. Connect the ac power ground wire to the ground bar so the device chassis ground is connected to the earth ground.
14. Make sure the wiring is not touching the sensor assembly.
15. Install the circuit board cover.
16. Use a 1/4-inch hex driver to install the 4 hex nuts on the circuit board cover.
17. Disconnect the ESD wrist strap from the ESD connection point inside the enclosure.
18. Close the enclosure.
19. Latch the two latches.
20. If applicable, attach the locking mechanism.
21. Supply electrical power to the device.

Relay Outputs

See the [Figure 11, p. 14](#) for details.

The TruSense™ RMWH Refrigerant Monitor has the following five single-pole, double-throw (SPDT) relays. The relay contacts are rated 8 A at 240 Vac/24 Vdc. Each relay can be connected as normally open (NO) or normally closed (NC).

- Fault
- Alarm
- Warning
- Caution
- Horn

Initial Setup

⚠ WARNING

Risk of Asphyxiation!
 Failure to follow instruction below could cause inaccurate readings and improper gas monitoring which could result in death or serious injury.
 Remove cap from exhaust port prior to device operation.

Remove the protective film from the touchscreen.
 When power is supplied to the device, the green power indicator LED (see preceding figure) illuminates and the touchscreen shows a logo and a loading bar. The loading bar indicates the status of the initializing process.



If an error occurs during start-up, a pop-up identifies the specific problem.

Language/Date and Time/Password

1. On the **Initial Setup** screen, select **Language/Date and Time/Password**.

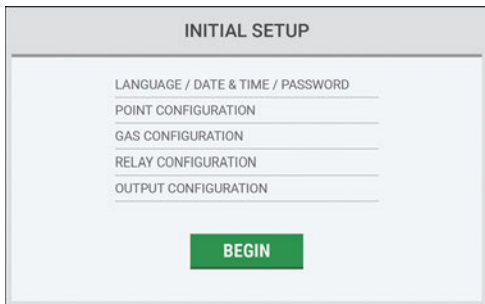



2. On the **Language Setup** screen, select the appropriate language, then select **Next**.

When a language is selected, the change is instantaneous.

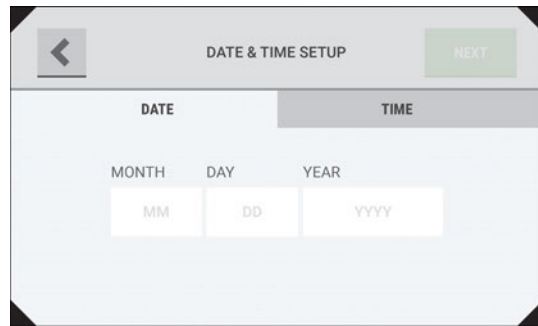

3. On the **Date and Time Setup** screen, select the **Date** tab. The date format can be MM/DD/YYYY or DD/MM/YYYY depending on the language setting.



4. Select the **Month/Day/Year** fields, and use the alphanumeric keypad pop-up to enter values. Select  to accept the values.



Note: An entry for the date is necessary to continue. If this error pop-up shows, select **OK** to return to the previous screen and supply a value.

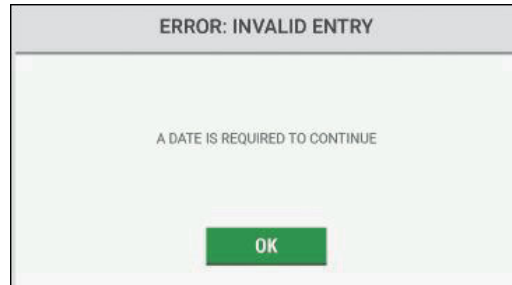

5. Select the **Time** tab.

6. Select the **Hour/Minute** fields, and use the alphanumeric keypad pop-up to enter values. Select  to accept the values.

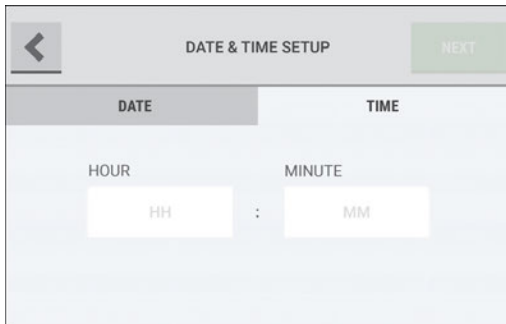

The time format can be 12 hours (AM/PM) or 24 hours depending on the language setting.

7. If applicable, select **AM** or **PM**.
8. Select **Next**.

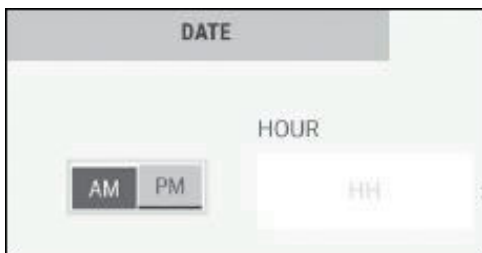

Note: A valid entry for the time is necessary to continue. If this error pop-up shows, select **OK** to return to the previous screen and supply a value.

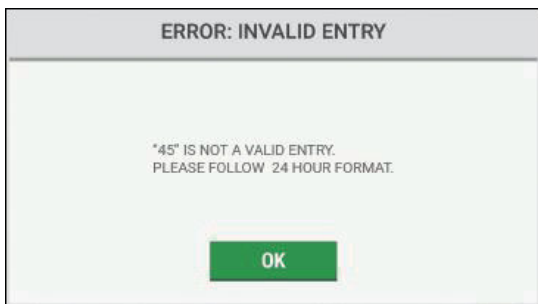

9. On the Password screen, select **Disabled** or **Enabled** to disable or enable password protection for editable screens.

If password protection is disabled, the **Create Password** and **Verify Password** fields are inactive.

Note: If password protection is enabled, do the following:

- a. Select the **Create Password** field, and use the alphanumeric keypad pop-up to enter a value. Select  to accept the value.

- b. Select the **Verify Password** field, and use the alphanumeric keypad pop-up to enter a value. Select  to accept the value.

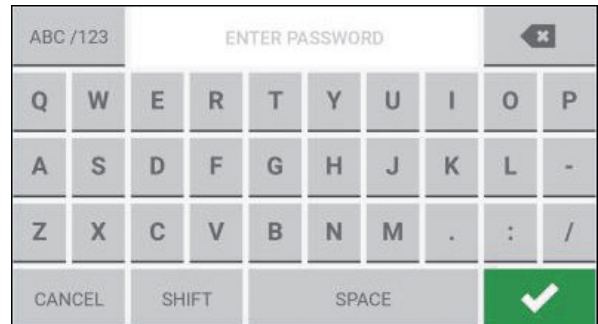

10. Select **Next**.

If password protection is enabled, the **Password Required** pop-up will show when any user tries to change an editable screen.

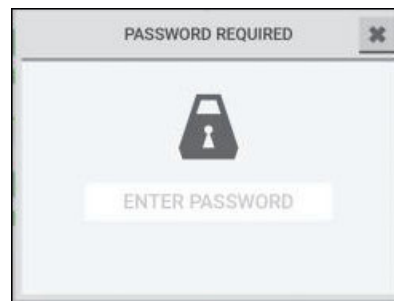

11. The **Initial Setup** screen shows a check mark beside the **Language/Date and Time/Password** step to indicate that it is complete. Select **Continue** to go to the point configuration setup.

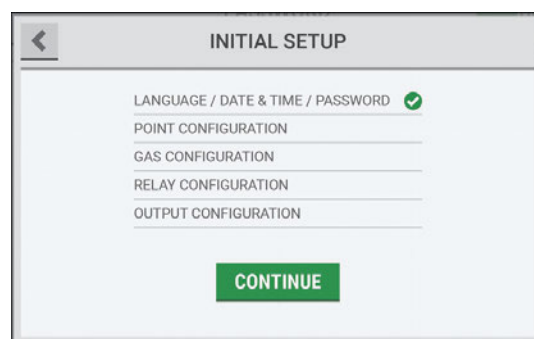

Point Configuration

Note: At initial setup, all points except Point 1 are disabled by default and are inactive on the **Point Configuration** screen. Configuration of Point 1 is required for device initialization.

1. On the **Point Configuration** screen, select **Point 1**.
2. Select **Next**.

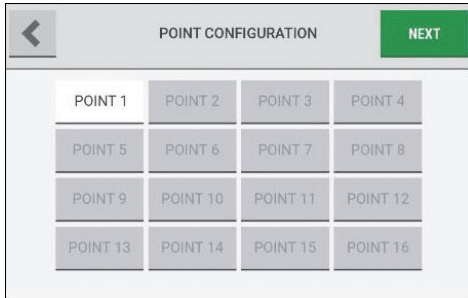

- On the **Point Configuration: Point #** screen, select **Enable**.
- Select the Name field, and use the alphanumeric keypad pop-up to assign a name with up to 18 characters. Select  to accept the value. The entire 18 characters will only show on the **Point Detail** screen. Only 10 characters will show on the **Point Configuration** screen.
- Select **Save**.
- Repeat [Step 1.](#) through [Step 5.](#) until all of the necessary points have been configured.

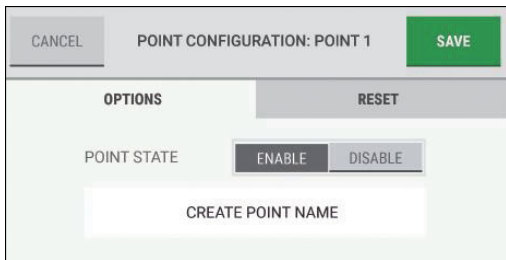

- On the **Point Configuration** screen, select **Next**.

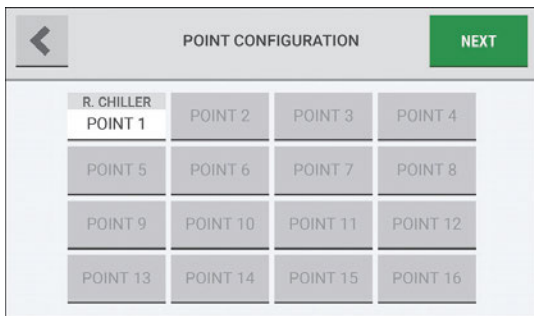

- The **Initial Setup** screen shows a check mark beside the **Point Configuration** step to indicate that it is complete. Select **Continue** to go to the gas configuration setup.



Gas Configuration

- On the **Select Gas** screen, select an empty gas slot.
- Note:** A maximum of six slots or gases can be configured.

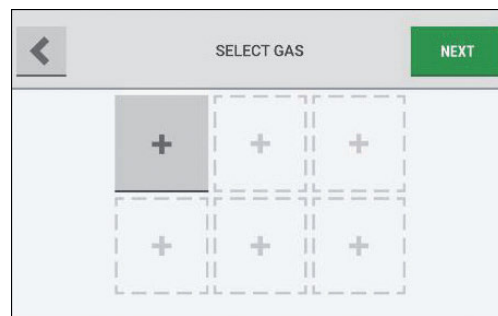

Note: If **Next** is selected without configuring a gas, a warning pop-up provides an alert that default settings will be applied across all points.

To accept the default settings and bypass the gas configuration step, select **OK**. Otherwise, select **Cancel** to return to the **Select Gas** screen and select a gas slot.

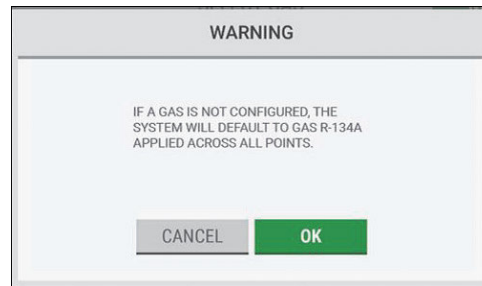

- On the **Gases** tab of the **Configure Gas** screen, select from the list of possible configurable gases. The screen header changes to show the selected gas.

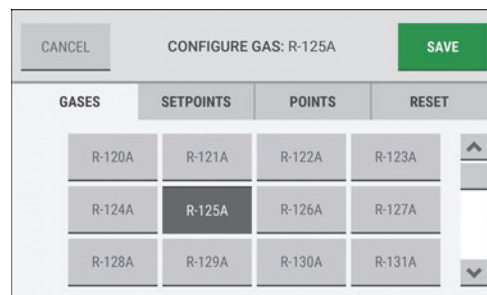

Note: When a gas is selected, the **Save** button becomes active. The interface does not automatically move to the **Setpoints** tab.

If **Save** is selected without adjusting the setpoints for cautions, warnings, and alarms, the default setpoint settings will be used for the selected gas.

3. Select the **Setpoints** tab.
4. Select the **Edit** button for Caution, Warning, or Alarm, as applicable.

Note: If the **Setpoints** tab is selected but a gas has not been selected, the options on the **Configure Gas** screen will be inactive.

The options for the configuration settings for cautions, warnings, and alarms are identical.



5. In the configuration pop-up, for **State**, select **Enabled** or **Disabled**.

If **Disabled** is selected, all other options are inactive. Go to [Step 8](#).

6. For **Setpoint**, use the and buttons to adjust the value.
7. For **Action**, select **Latching** or **Non-Latching**.

Note: For a definition of latching and non-latching events, see [“Cautions, Warnings, and Alarms,” p. 29](#).

For a list of default settings, see [“Appendix C: Default Settings,” p. 54](#).

Use the scroll bar to see all of the configuration options.

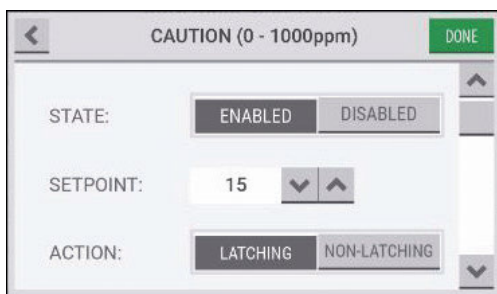

8. To associate an audible horn or a visual strobe with the event, for **Alarm Indication**, select the **Horn** and/or **Strobe** check boxes.

9. Select **Done** to accept the settings and return to the gas-specific configuration screen, which shows the updated settings.



10. Repeat [Step 2](#) through [Step 9](#) until all event setpoints have been configured.

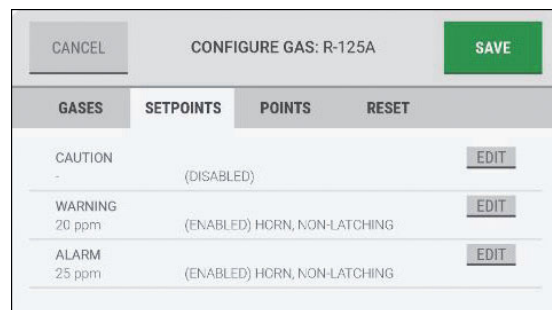

11. Select the **Points** tab.
12. Select the applicable checkbox to assign a point to the gas.

Note: If the **Points** tab is selected but a gas has not been selected, the options on the **Configure Gas** screen will be inactive.

Only one gas can be assigned to a single point. Points that have already been assigned a gas are not available for selection.

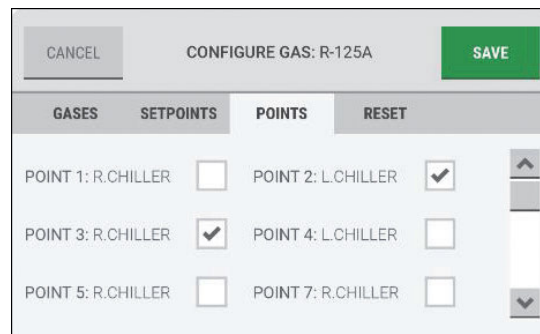

13. Select **Save**.
14. Repeat [Step 1](#) through [Step 13](#) for each gas to be configured.

Note: The **Reset** tab is not used during the initial setup. For information about the **Reset** tab, see [“Gas Configuration,” p. 34](#).

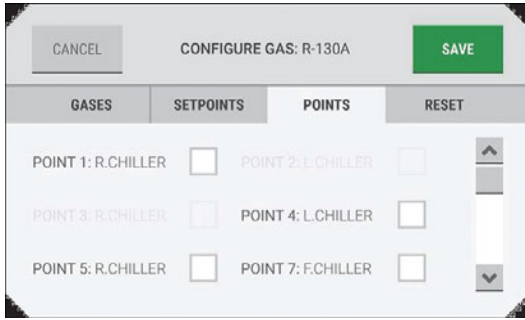

15. When all applicable gases have been configured, select **Next**.

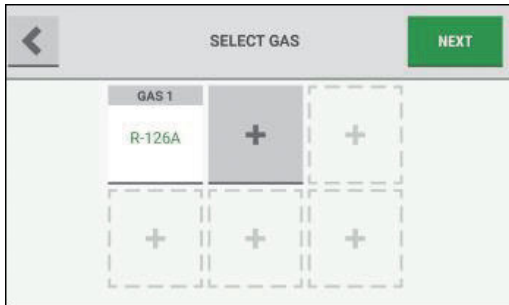

16. The **Initial Setup** screen shows a check mark beside the **Gas Configuration** step to indicate that it is complete. Select **Continue** to go to the relay configuration setup.

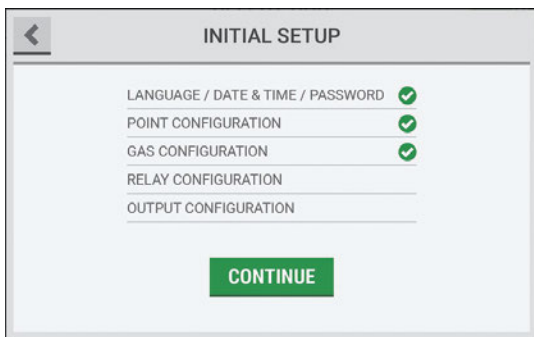

Relay Configuration

Each relay is mapped to a specific predetermined function; that is, fault, alarm, warning, caution, or horn.

1. On the **Configure Relays** screen, select **Edit** for the function to configure.

Note: *The options for the configuration settings for alarms, warnings, cautions, and the horn are identical.*

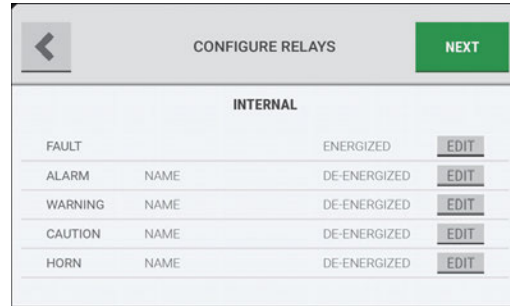

The default setting for the internal fault relay is the energized state. To test the relay, do the following:

- Select **ON**.
- Select **OFF**.



2. In the relay configuration pop-up, select the **Name** field, and use the alphanumeric keyboard pop-up to enter a value.

Relay names can have eight characters.

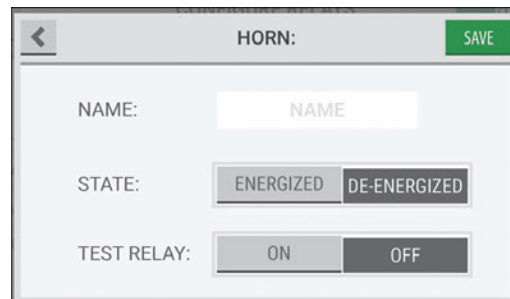

The title in the pop-up header changes to show the assigned name.

3. Select **Energized** or **De-energized** for the relay state.
4. Do the following to test the relay:
 - a. Select **ON**.
 - b. Make sure the equipment connected to the relay operates as expected.
 - c. Select **OFF**.
5. Select **Save**. The updated settings for the relays show on the **Configure Relays** screen.



6. Repeat [Step 1.](#) through [Step 5.](#) for each relay to be configured.
7. When all relays have been configured, select **Next**.



8. The **Initial Setup** screen shows a check mark beside the **Relay Configuration** step to indicate that it is complete. Select **Continue** to go to the output configuration setup.

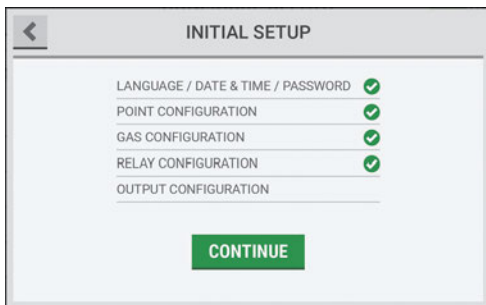

Communications Output

There are three options available to support digital outputs.

For a list of the registers that are available for exchange with the MODBUS™ controller, see [“Appendix D: MODBUS Holding Registers,”](#) p. 55.

For a list of the BACnet® Objects that are available for exchange with the BACnet® controller, see [“Appendix E: BACnet Objects,”](#) p. 59.

1. On the **Digital** tab of the **Outputs** screen, select one of the following:

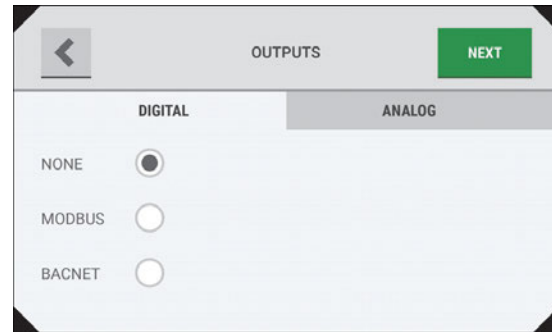

2. If **None** is selected, no digital communication is configured.
3. If **MODBUS** is selected, do the following:
 - a. Select **Edit**.

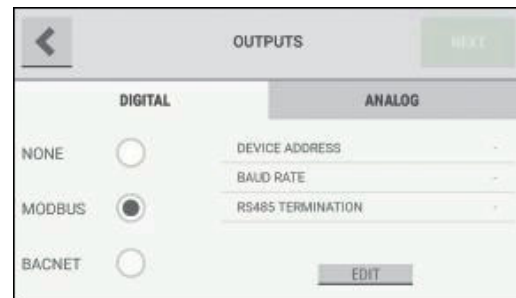

- b. Select the Device Address field, and use the alphanumeric keypad pop-up to enter a value. Select  to accept the value.
- c. Select a baud rate for the connection.
- d. Select the **RS485 Termination** check box.
- e. Select **Done**.

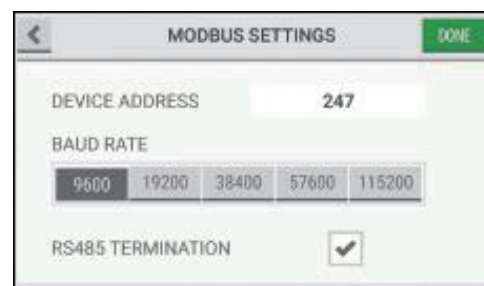

4. If **BACnet** is selected, do the following:
 - a. Select **Edit**.

Initial Setup

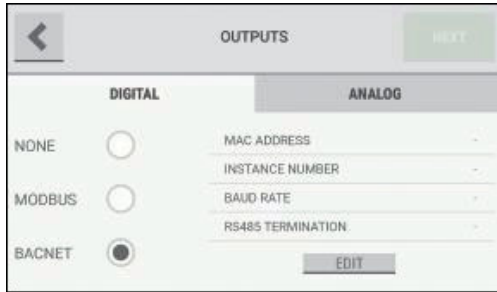

b. Select the **MAC Address** field, and use the alphanumeric keypad pop-up to enter a value.

Select  to accept the value.

c. Select the **Instance Number** field, and use the alphanumeric keypad pop-up to enter a value.

Select  to accept the value.

d. Select a baud rate for the connection.

Use the scroll bar to move through the list of available options.

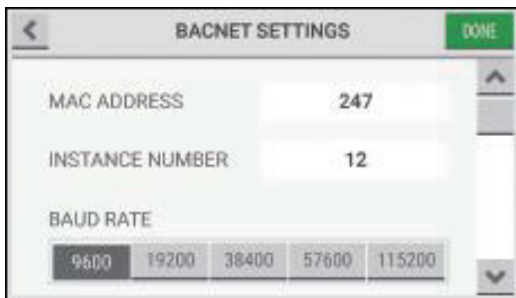

5. Select the **Analog** tab.

6. To adjust the default values, select the applicable field, and use the alphanumeric keypad pop-up to enter a value. Select  to accept the value.

7. Select **Next**.

For a list of default settings, see “Appendix C: Default Settings,” p. 54.



8. The **Initial Setup** screen shows that all initial setup steps are complete. Select **Finished** to confirm the configuration settings and move to the **Initial Calibration** screen.



Calibration

⚠ WARNING

Risk of Asphyxiation!

Failure to follow instruction below could cause inaccurate readings and improper gas monitoring which could result in death or serious injury. Remove cap from exhaust port prior to device operation.

⚠ WARNING

Risk of Asphyxiation!

Failure to follow instructions below could cause inaccurate readings and improper gas monitoring which could result in death or serious injury.

Follow proper calibration procedures:

- Power device for a minimum of two hours before calibration.
- Use only a demand-flow regulator for calibration. Do not use constant-flow gas regulator.
- If calibration is unsuccessful, remove device from service until resolved.

Note: During the calibration process, the device is not monitoring for gas.

Calibration is the process of applying a known quantity of gas to the device so it can adjust the precision and accuracy of the measurements made during routine operating modes. This process ensures that gas measurements are as accurate as possible.

Although the TruSense™ RMWH Refrigerant Monitor sensor is factory calibrated, it is recommended that calibration be performed at initial start-up and at regular intervals to ensure that the sensor is fully functional and improve the accuracy of the device.

There are two types of calibration: zero gas calibration and span gas calibration.

Zero gas calibration resets the baseline level reading to zero. Use the zero-gas scrubber with ambient air for zero calibration.

Span gas calibration applies a known concentration of target gas so the accuracy and precision of the detector can be adjusted to the known value. The known concentration of gas is called a span value because it represents the span, or reach, of the calibration curve from zero to that value (see the following figure).

Figure 12. Calibration curve

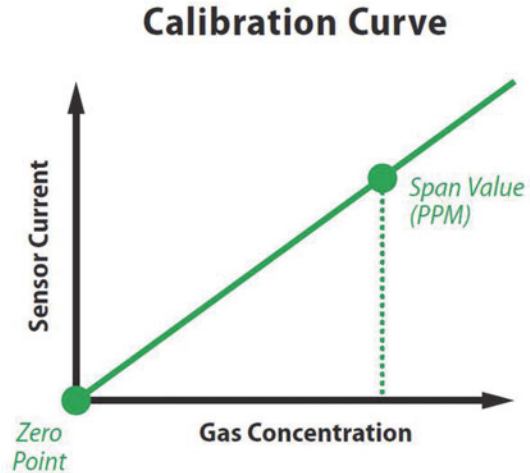

The device sensor is factory calibrated for many of the most commonly used refrigerant gases. The sensor also has an extended pre-programmed library of additional refrigerant gases that can be used to set up the device to detect other targeted refrigerant gases.

Initial Setup

Following the initial setup, an initial calibration must be completed to ensure sensor accuracy.

For a description of the dashboard, see [“Dashboard Overview,”](#) p. 28.

1. On the **Initial Calibration** screen, select **Calibrate Now**.
2. Go to **Step 2** in [“Routine Operation,”](#) p. 24.

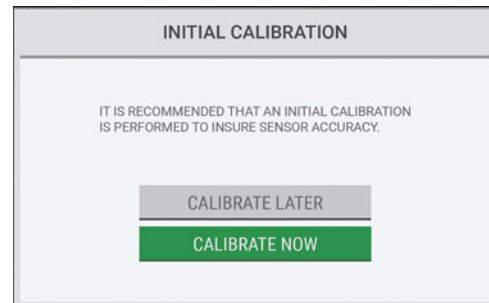

Note: If **Calibrate Later** is selected, the dashboard shows a notification on the **Calibration** button until the initial calibration is completed.

Select **Calibrate** to re-open the **Initial Calibration** screen and select **Calibrate Now**.



Routine Operation

⚠ WARNING

Risk of Asphyxiation!

Failure to follow instruction below could cause inaccurate readings and improper gas monitoring which could result in death or serious injury. Remove cap from exhaust port prior to device operation.

Starting Calibration

1. To start the calibration process, on the dashboard, select **Calibrate**.



2. On the bottom of the device, remove the pin from the calibration port.



3. On the device touchscreen, select **Start**.

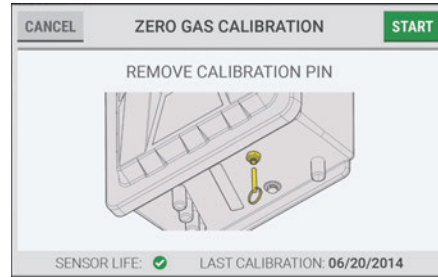

Stopping Calibration

During some phases, when **Cancel** is available in the top left corner, the calibration process can be stopped.

1. To stop the calibration process, select **Cancel**.

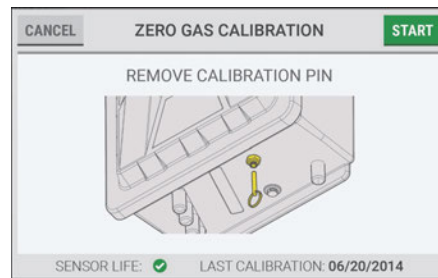

2. For zero-gas calibrations, disconnect the zero-gas scrubber tubing from the calibration port, then select **Next** on the device touchscreen.

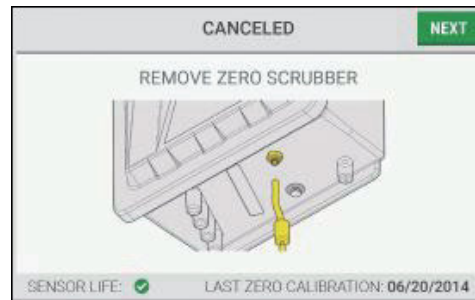

3. On the **Canceled** screen, select **Done**.
4. On the bottom of the device, install the pin in the calibration port.

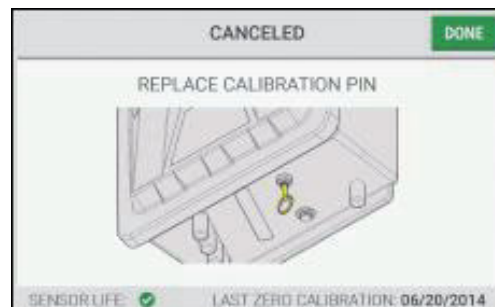

5. On the **Calibration Complete** screen, do one of the following:

- a. To continue with span gas calibration, select **Span Gas Calibration**. Go to **Step 1**. in “**Span Gas Calibration**,” p. 25.
- b. To complete zero gas calibration without continuing to the span gas calibration, select **Done**, and go to the next step.
- c. To return to the **Results** screen, select **Back**.

Zero Gas Calibration

1. Connect the zero-gas scrubber tubing to the calibration port.
2. On the device touchscreen, select **Next**.



A progress bar shows during the zero gas calibration.

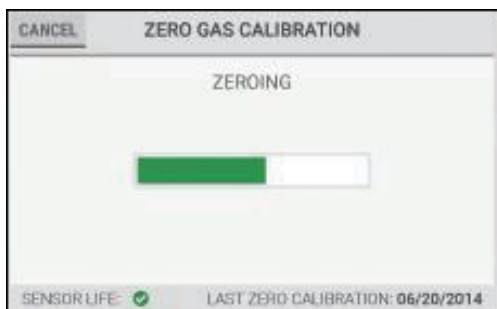

3. When zero gas calibration is complete, the **Results** screen shows. Select **Continue** to go to the next step.

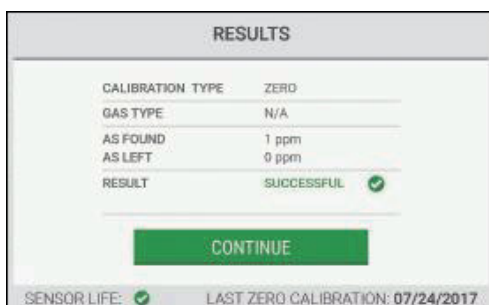

4. On the bottom of the device, install the pin in the calibration port.
5. Remove the tubing from the calibration port.



6. Disconnect the zero-gas scrubber tubing from the calibration port.
7. On the device touchscreen, select **Next**.



Span Gas Calibration

Note: To prevent zero-gas contamination, Trane recommends using different regulators to do zero gas calibration and span gas calibration.

1. Close the cylinder valve.
2. If applicable, remove the zero-gas cylinder or zero-gas scrubber tubing from the calibration port.
3. On the **Span Gas Calibration** screen, select the applicable span gas.

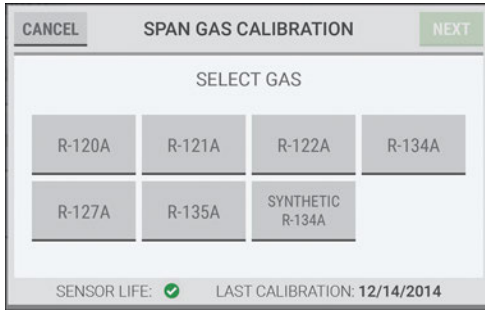

Note: A maximum of seven gases show on the **Select Gas** screen: six user-selected gases and one universal gas (Synthetic R-134A).

4. On the gas cylinder label, find the concentration for the gas.
5. On the **Set Span Gas Value** screen, to adjust the concentration value to the value on the gas cylinder label, either use the and buttons to increase or decrease the value in 1 ppm increments, or select the value field and use the alphanumeric keypad pop-up to enter the value. Select to accept the value.
6. To do the calibration with synthetic R-134A, select the check box.
7. Select **Next**.

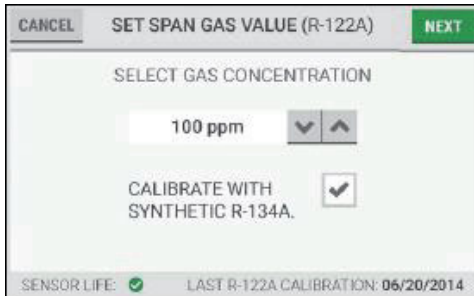

Note: The concentration value can be set between 50 and 500 ppm.

8. Attach the span-gas cylinder tubing to the calibration port.
9. Open the span-gas cylinder valve.
10. On the **Span Gas Calibration** screen, select **Start**.

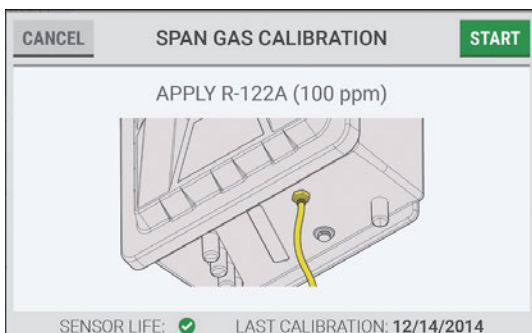

A progress bar shows during the span gas calibration.



11. When span gas calibration is complete, the **Results** screen shows. Select **Continue**.



12. On the **Calibration Complete** screen, do one of the following:
 - a. To do a span gas calibration for another gas, select **Select Another Gas**. Repeat [Step 3](#). through [Step 11](#).
 - b. To return to the **Results** screen, select **Back**.
 - c. To go to the next step, select **Continue**.
13. Close the span gas cylinder valve.



14. On the **Set Reminder** screen, select the applicable button for the calibration interval. At the selected interval, a pop-up will signal the need for calibration.
15. Select **Next**.



16. On the bottom of the device, install the pin in the calibration port.
17. Remove the tubing from the calibration port.



18. On the device touchscreen, select **Done**.



Unsuccessful Calibrations

In the unlikely event that a problem occurs during a calibration process, the **Results** screen will show the calibration status as **Unsuccessful**.

1. On the **Results** screen, select **Continue**.

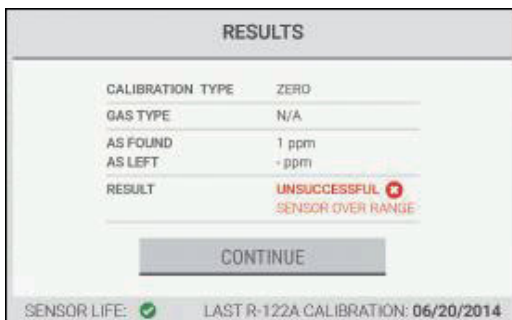

2. On the **Calibration Unsuccessful** screen, do one of the following:

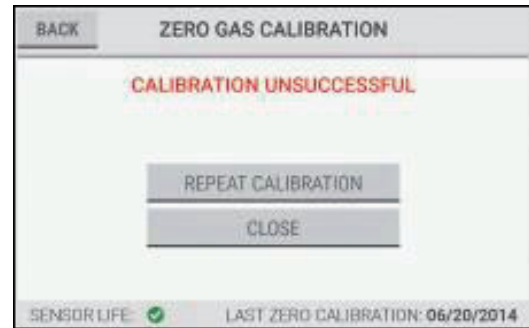

- a. For zero gas calibrations:
 - i. To retry the zero gas calibration, select **Repeat Calibration**.
 - ii. To return to the previous calibration values, select **Close**.



- b. For span gas calibrations:
 - i. To do a span gas calibration for another gas, select **Select Another Gas**.
 - ii. To retry the span gas calibration, select **Repeat Calibration**.
 - iii. To return to the previous calibration values, select **Close**.

If Close is selected, on the dashboard, a gray check mark identifies the points that are affected by the unsuccessful calibration. The gas readings for these sample points are below the alarm threshold but may not be completely accurate.

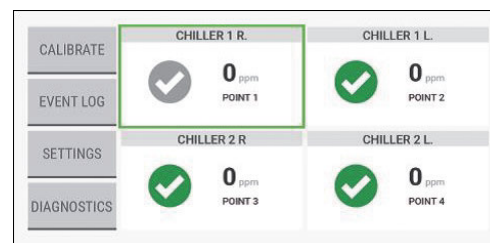

Routine Operation

⚠ WARNING

Risk of Asphyxiation!

Failure to follow instruction below could cause inaccurate readings and improper gas monitoring which could result in death or serious injury. Remove cap from exhaust port prior to device operation.

Dashboard Overview

After the initial setup, the dashboard shows the main function buttons and tiles for the points that are enabled.

A green box around the tile identifies the point currently being sampled.

Point tiles are titled by name, not number.

When 2–4 points are enabled, large tiles show the point name, number, current gas reading, and status.

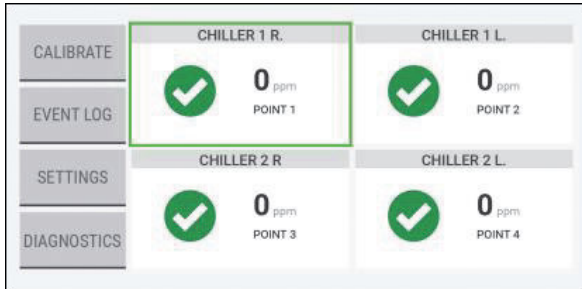

When 5–8 points are enabled, medium tiles show the point name, number, current gas reading, and status.

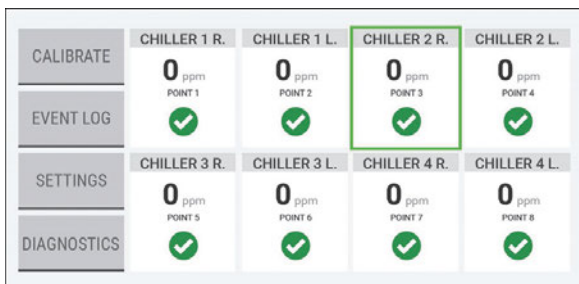

When 9–16 points are enabled, small tiles show the point name, number, current gas reading, and status.

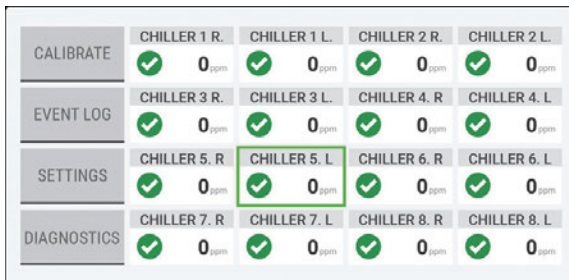

Point Details

To see details about a specific point, on the dashboard, select the point tile. A detail pop-up opens.

To close the detail pop-up and return to the dashboard, select the **X** at the top right corner.

To hold and lock onto a point for an extended period manually, in the point detail pop-up, select **Hold**.

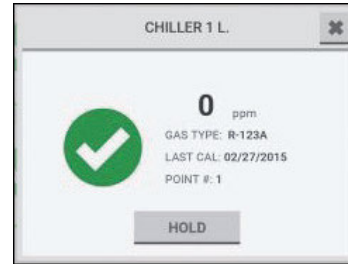

Point Hold

Automatic Point Hold

During routine operation, when any sample point detects gas that results in a caution/warning/alarm (C/W/A), the device automatically holds that sample point for an additional four gas measurement cycles to analyze the point further and provide more data. When the additional four measurement cycles are complete, the device goes to the next point and resumes routine sample times.

When the sampling cycle returns to the point that triggered the automatic hold, the automatic hold state continues unless the non-latching event no longer exists (that is, the gas concentration decreases below the C/W/A threshold) or the latching alarm event has been reset.

Manual Point Hold

To set the duration of the Hold feature, use the and buttons.

To disable the point alarm for the duration of the hold, select the **Disable Alarm** checkbox.

To activate the Hold feature, select **Hold**.

To cancel the Hold feature, select **Cancel** or the **X** at the top right corner.



Note: The Hold feature can only be applied to one point at a time. During the hold duration for the selected point, the **Hold** button is inactive for all other points until the hold duration for the selected point has completed.



Predictive Warnings

When a point goes above the acceptable threshold for flow rate, sensor performance, or pump performance, a predictive warning pop-up shows on the dashboard.

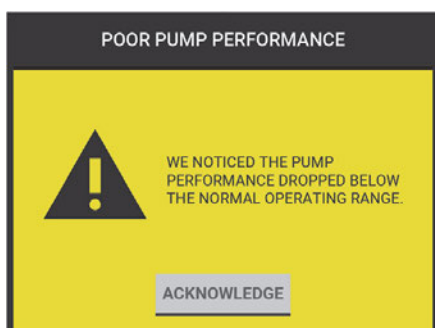
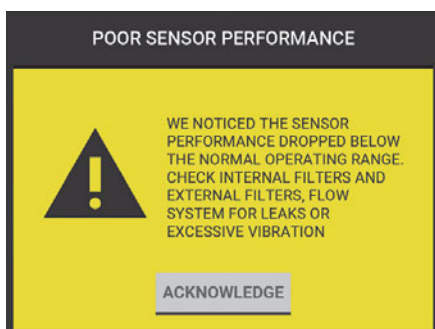
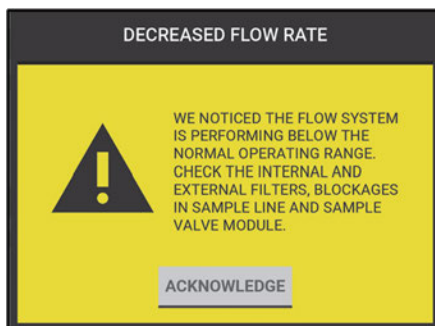

Predictive warnings indicate that it may be necessary to do troubleshooting or replace a part, not that there is a critical issue with the flow rate, sensor, or pump.

To acknowledge the predictive warning and return to the dashboard, select **Acknowledge**.

Acknowledging the predictive warning triggers a notification that shows on the **Diagnostics** button on the dashboard.

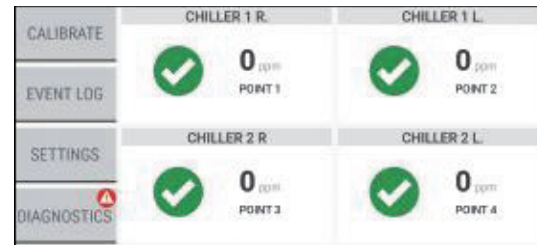

A corresponding notification also shows on the **Diagnostics** screen. For information about diagnostics, see “Diagnostics,” p. 39.

Cautions, Warnings, and Alarms

Cautions, warnings, and alarms can be triggered by non-latching or latching events. Non-latching events do not require user interaction for resolution. Latching events require user interaction for resolution.

When an event occurs, a pop-up shows on the dashboard.

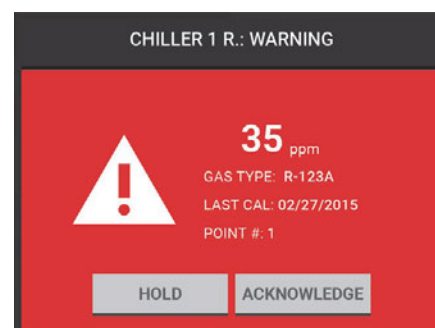
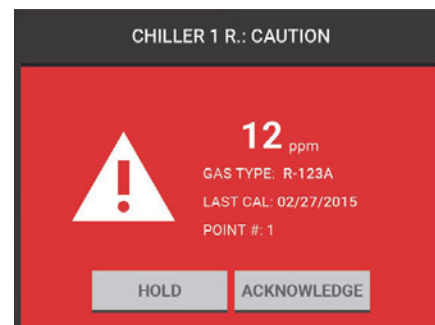

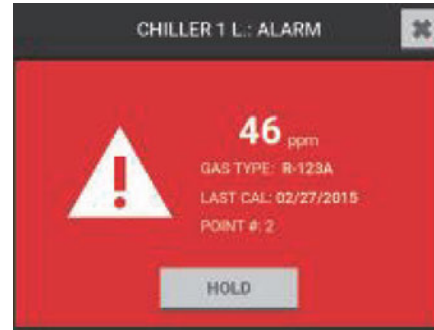
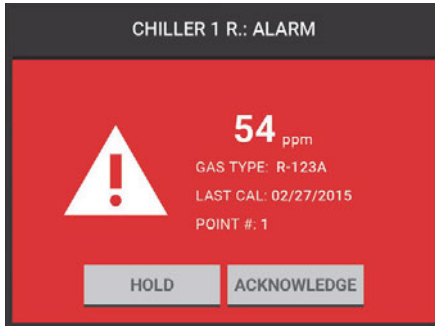

Non-Latching Events

Non-latching events do not require user interaction for resolution. For a non-latching event, if the gas reading goes below the caution, warning, or alarm threshold before **Acknowledge** is selected, the pop-up disappears from the dashboard, the background of the point tile on the dashboard changes from red to white, the event is catalogued in the Event Log, and a notification shows on the **Event Log** button on the dashboard.

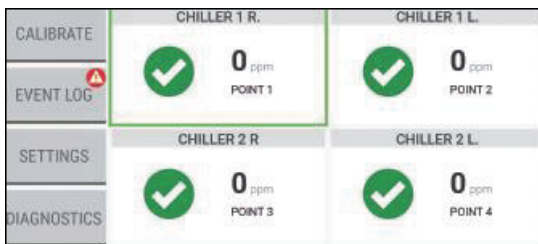

For information about the Event Log, see “[Event Log](#),” p. 31.

A corresponding notification of the event shows on the **Diagnostics screen**. For information about diagnostics, see “[Diagnostics](#),” p. 39.

Latching Events

Latching events require user interaction for resolution. For a latching event, **Acknowledge** must be selected on the pop-up to return to the dashboard. If a horn is enabled for the point, selecting **Acknowledge** silences the horn, but the event is not yet resolved. The point tile shows in red on the dashboard to indicate the unresolved event.

Select the point tile with the event to see a detail pop-up.

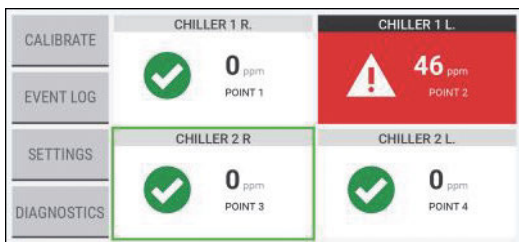

While the gas reading is above the event threshold, the **Reset** button on the detail pop-up is hidden, and the event cannot be resolved.

When the gas reading goes below the event threshold, the **Reset** button is active.

Select **Reset** to resolve the event and return to the dashboard. The point tile on the dashboard shows in its normal state, and the event is considered resolved.

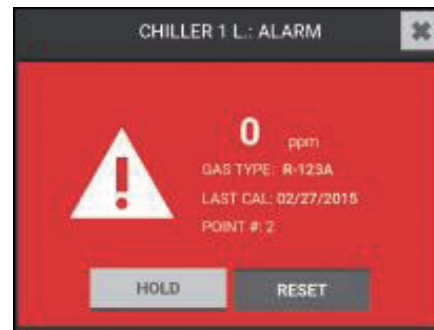

A corresponding notification of the event shows on the **Diagnostics screen**. For information about diagnostics, see “[Diagnostics](#),” p. 39.

Faults

There are two types of faults: noncritical and critical.

Alarm events have priority over fault events. If a point has an alarm during a fault event, the point tile on the dashboard shows in red to indicate the alarm, not in yellow to indicate the fault.

Faults can be acknowledged and reset through the pop-up if it is a channel related fault.

If the fault is system related, it is acknowledged and reset through the fault tab in the event log. Once the reset is initiated on the system related faults, it will reset all of the faults concurrently.

For faults related to the display, the system will notify the user upon reset.

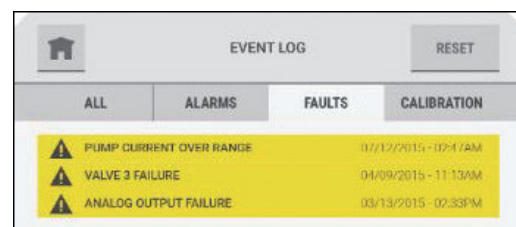

Noncritical Faults

When a noncritical fault occurs, a pop-up with a yellow background signals the event on the dashboard.

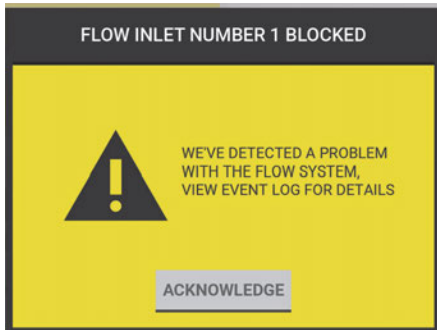

If multiple faults occur simultaneously, the pop-up shows the faults as line items.

To acknowledge the event and return to the dashboard, select **Acknowledge**.

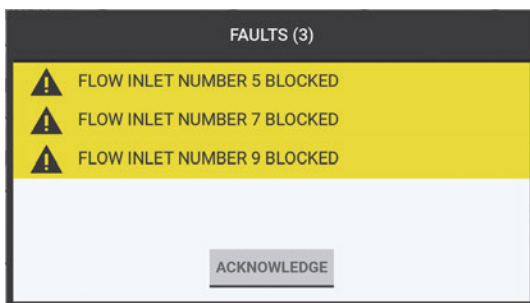

If the fault can be related to a single or multiple points, the associated point tiles show on the dashboard with a yellow background.

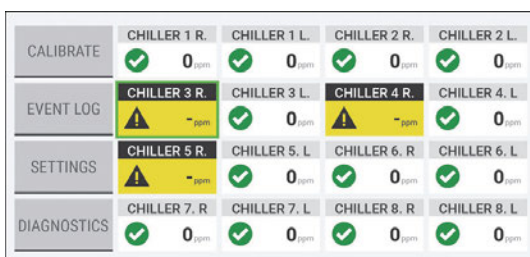
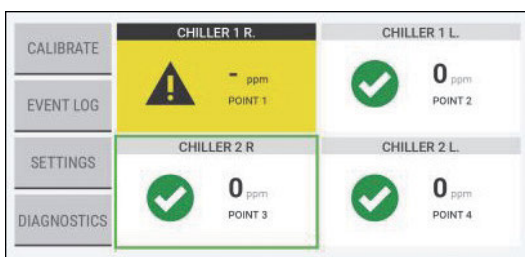

If the fault cannot be related to a single point or multiple points, the dashboard shows in a normal state.

To see the details about a specific point, on the dashboard, select the point tile.

To see the details about the fault itself, go to the Event Log, **Faults** tab. See “Event Log,” p. 31.

Critical Faults

⚠ WARNING

Risk of Asphyxiation and Explosion!
Failure to follow instructions below could result in death or serious injury.
Do not use device if it is in critical fault mode, as it is no longer monitoring for gas. Repair the fault as soon as possible to re-establish monitoring.

A critical fault causes the following to occur:

- The fault relay trips.
- The device cannot monitor for gas.
- The 4 to 20 mA output decreases to the user-specified fault level.
- All modules except the main board and display shutdown.
- All point tiles show on the dashboard with a yellow background and a black **X** icon.

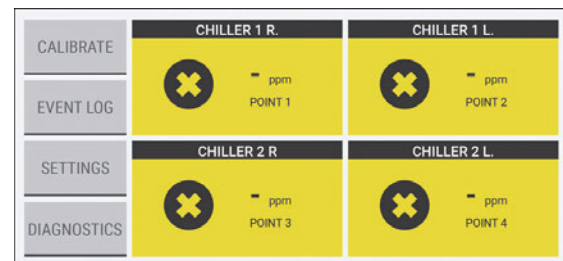

Note: If more than four events occur, use the scroll bar to see the entire list of faults.

To acknowledge the events collectively and return to the dashboard, select **Acknowledge**.

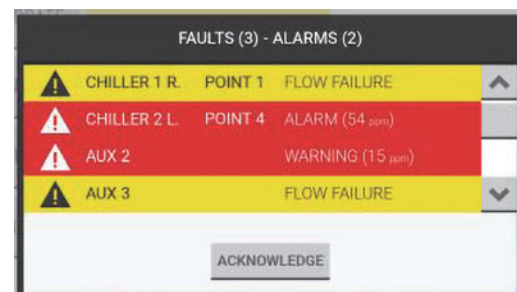

Event Log

On the dashboard, select the Event Log button.



Routine Operation



All

The **All** tab shows a list of all types of events for the device. The last 25 events show in chronological order. When there are 25 events in the list and a new event occurs, the oldest event is deleted to make space for the new event to show. Use the scroll bar to move through the list of events.

In the Event Log, events are color coded by type:

- Red = Caution, Warning, Alarm
- Yellow = Fault, Unsuccessful Calibration
- Green = Successful Calibration

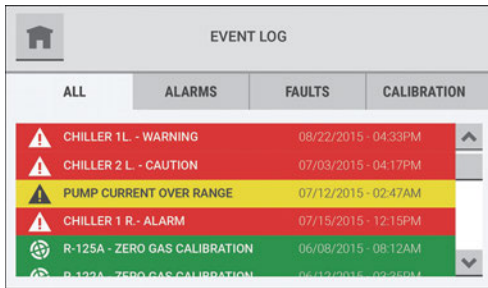

Select any event on the All tab to see a pop-up with the event details.

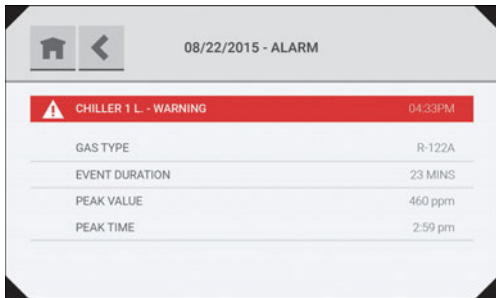

Alarms

The **Alarms** tab shows a list of alarm events for the device. Non-latching alarm events that resolved without being acknowledged are indicated by a number in parentheses after the **Alarms** tab heading.

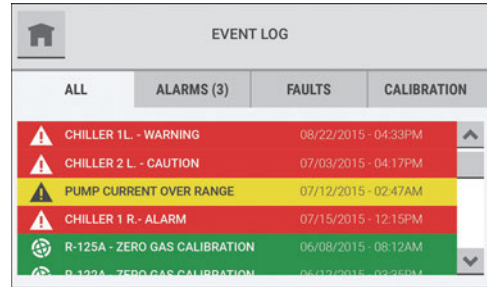

A single alarm event is divided into two events in the event log: one for the initiation of the alarm and another for the conclusion of the alarm.

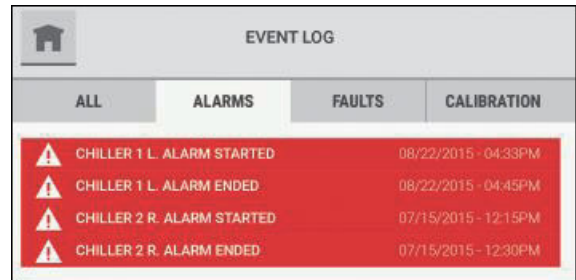

The last 100 events show in chronological order. When there are 100 events in the list and a new event occurs, the oldest event is deleted to make space for the new event to show.

Use the scroll bar to move through the list of events.

Select any event on the Alarms tab to see a pop-up with event details.

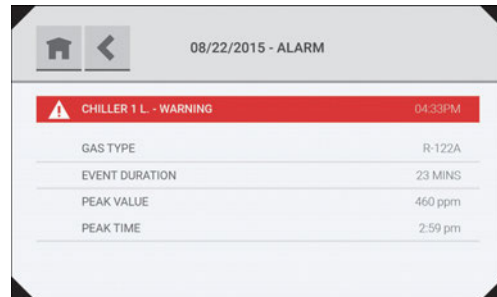

Faults

The **Faults** tab shows a list of all fault events for the device.

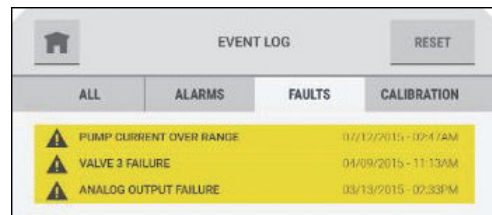

The last 100 events show in chronological order. When there are 100 events in the list and a new event occurs, the oldest event is deleted to make space for the new event to show.

Use the scroll bar to move through the list of events.

Select any event on the **Faults** tab to see a pop-up with event details. The detailed view shows the board location, if applicable, and the software error code.

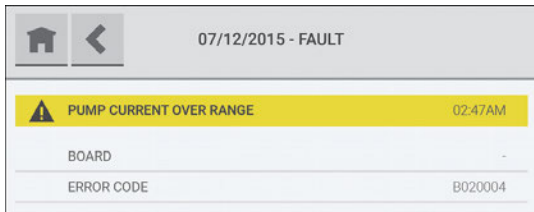

Calibration

The **Calibration** tab shows a list of calibration attempts for the device.

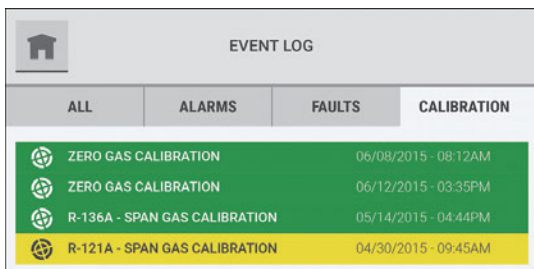

The last 20 calibrations show in chronological order. When there are 20 calibrations in the list and a new calibration occurs, the oldest calibration is deleted to make space for the new calibration to show.

Use the scroll bar to move through the list of events.

Select any calibration event to see a pop-up with details

Note: The **As Found** value represents the performance reading before calibration is performed. The **As Left** value represents the performance reading after calibration is performed.



Edit Settings

To access and edit the device settings that were assigned during the initial setup, on the dashboard, select the **Settings** button.

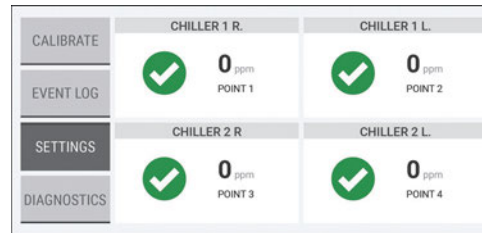

If password protection was enabled during the initial setup, on the Password Required pop-up, enter the correct password.

For help with forgotten passwords or password resets, contact local Trane Customer Service.

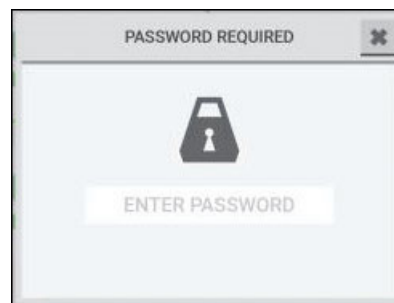

Preferences

Use the **Preferences** option to change the settings for the language, date and time, password, and brightness of the device display.

On the **Settings** screen, select **Preferences**.

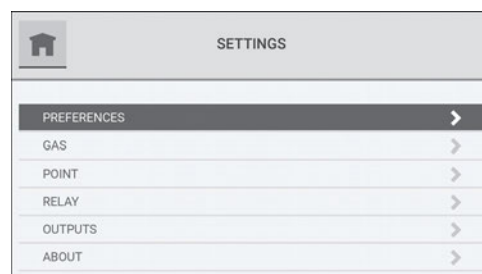

The **Preferences** screen shows the current values for the settings. Select the **Edit** button for the setting to change.

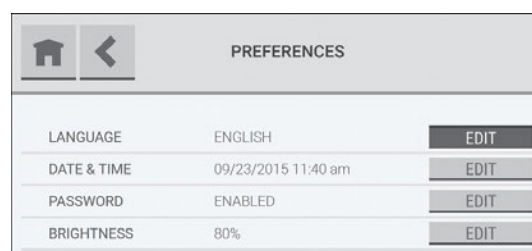

Language, Date and Time, and Password

Note: If the date setting is changed after the initial set up configuration, the predictive maintenance logs will need to be reset on each graph to ensure accuracy.

Except for the buttons that show in the screen headers, the screens and steps used to change the settings for the language, date and time, and password are the same as those used during the initial setup.

During the initial setup, the screen headers show the **NEXT** and buttons. During routine operation, the screen headers show the and buttons.

To adjust the settings for the language, date and time, and password, go to "Initial Setup," p. 16, and do Step 2. through Step 10.

To return to the Settings screen, select .

To return to the previous screen, select .

Brightness

On the **Brightness** screen, use the and buttons to increase and decrease the percentage of screen brightness.



Gas Configuration

Use the **Gas** option to change the gas configuration settings.

Note: Except for the buttons that show in the screen headers, the screens and steps used to change the gas configuration settings are the same as those used during the initial setup.

During the initial setup, the screen headers show the **NEXT** and buttons. During routine operation, the screen headers show the , , and **SAVE** buttons.

When a change is made to the configuration, the Save button becomes active.

1. On the **Settings** screen, select **Gas**.

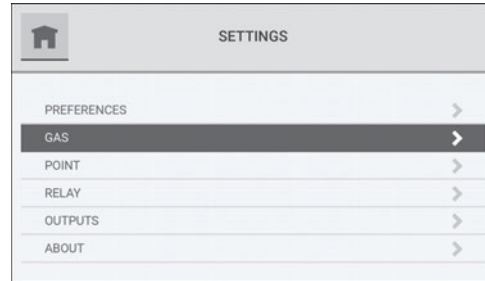

2. On the **Gas** screen, select the applicable gas tile.
3. Do one of the following:
 - a. To change the gas configuration settings, go to "Gas Configuration," p. 18, and do Step 2. through Step 13.
 - b. To clear or delete a configured gas, go to Step 1. in "Reset Tab," p. 35.

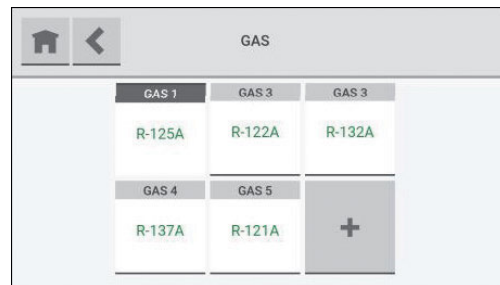

While the configuration is being updated, a **Busy** message shows at the bottom of the **Configure Gas** screen.



If the or button is selected while the **Busy** message shows, a pop-up asks whether to abandon the configuration changes.

- To return to the **Gas** screen without saving the configuration changes, select **Return without Saving**.
- To save the configuration changes and return to the **Configure Gas** screen, select **Save and Return**.



When the configuration changes have been saved, the Settings screen shows.

Reset Tab

Use the **Reset** tab to clear or delete a gas slot.

1. On the **Configure Gas** screen, select the **Reset** tab.
2. Do one of the following:
 - a. To return to the default settings for the currently selected gas, select **Clear**.
 - b. To remove the gas slot completely, select **Delete**.

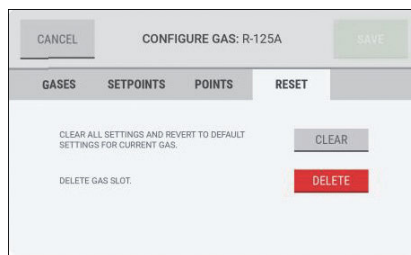

3. On the warning pop-up, do one of the following:
 - a. To cancel the Delete function, select **Cancel**.
 - b. To continue with the Delete function, select **Delete**.

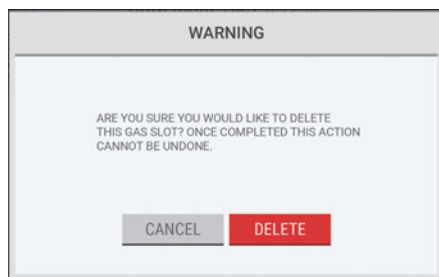

Note: *If only one gas slot is configured, it cannot be deleted. At least one gas slot must be configured for the system to function. If an attempt is made to delete the only configured gas slot, a warning pop-up indicates that the action cannot be completed.*

Select **Cancel** to return to the **Configure Gas** screen.

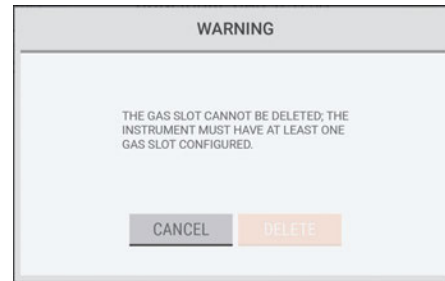

When the configuration changes have been saved, the Settings screen shows.

Point Configuration

Use the Point option to change the point configuration settings.

1. On the **Settings** screen, select **Point**.

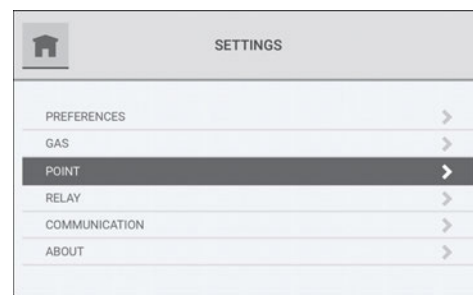

2. On the **Point** screen, select the applicable point.

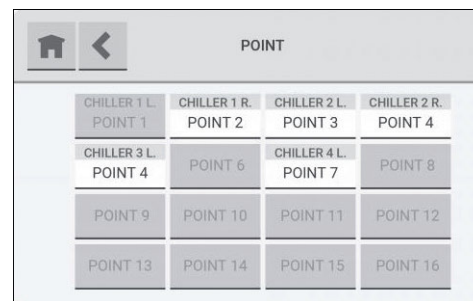

3. On the **Point Configuration: Point #** screen, do one of the following:

- a. To change the point configuration settings, select the **Options** tab, and go to [Step 4](#).
- b. To reset the point name and disable the point, go to [Step 1](#) in "[Reset Tab](#)," p. 36.

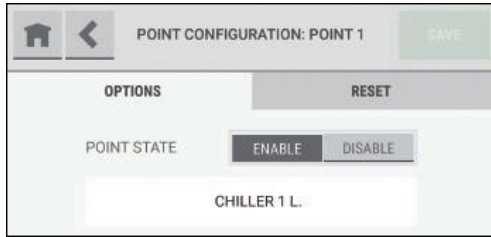

Note: *When a change is made to the configuration, the **Save** button becomes active.*

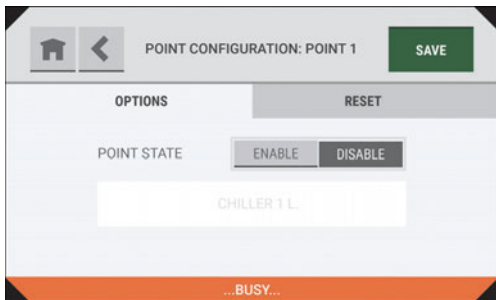

4. To change the point state, select **Enable** or **Disable**. If **Disable** is selected, the **Create Point Name** field is inactive.
5. To change the point name, select the name field, and use the alphanumeric keypad pop-up to assign a name with up to 18 characters. Select  to accept the value. The entire 18 characters will only show on the **Point Detail** screen. Only 10 characters will show on the **Point Configuration** screen.
6. Select **Save**.

While the configuration is being updated, a **Busy** message shows at the bottom of the **Point Configuration: Point #** screen.



If the  or  button is selected while the **Busy** message shows, a pop-up asks whether to abandon the configuration changes.

- To return to the **Point** screen without saving the configuration changes, select **Return without Saving**.
- To save the configuration changes and return to the **Point** screen, select **Save and Return**.

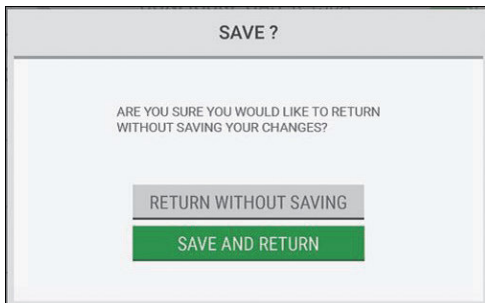

When the configuration changes have been saved, the **Settings** screen shows.

Reset Tab

Use the **Reset** tab to reset the point name and disable the point.

1. On the **Point Configuration: Point #** screen, select the **Reset** tab.
2. Select **Reset**.

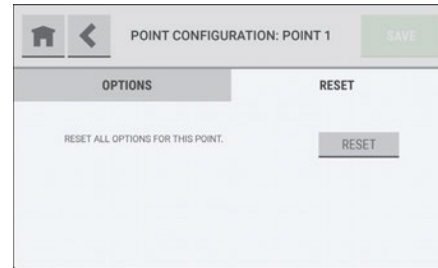

3. On the warning pop-up, do one of the following:
 - a. To return to the **Point Configuration: Point #** screen without resetting the point, select **Cancel**.
 - b. To reset the point name, disable the point, and return to the **Settings** screen, select **Reset**.

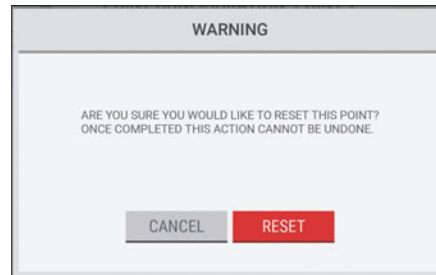

Note: If only one point is configured, it cannot be deleted. At least one point must be configured for the system to function. If an attempt is made to delete the only configured point, a warning pop-up indicates that the action cannot be completed.

Select **Cancel** to return to the **Point Configuration: Point #** screen.

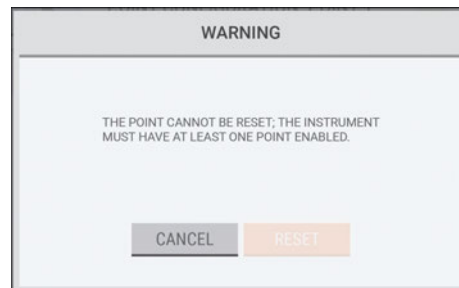

When the configuration changes have been saved, the **Settings** screen shows.

Relay Configuration

Use the **Relay** option to change the relay configuration settings or test a relay.

Note: Except for the buttons that show in the screen headers, the screens and steps used to change the relay configuration settings are the same as those used during the initial setup.

During the initial setup, the screen headers show the **NEXT** and buttons. During routine operation, the screen headers show the , , and **SAVE** buttons.

When a change is made to the configuration, the **Save** button becomes active.

On the **Settings** screen, select **Relay**.

To adjust the relay configuration settings, go to “[Relay Configuration](#),” p. 20, and do [Step 1.](#) through [Step 5.](#)

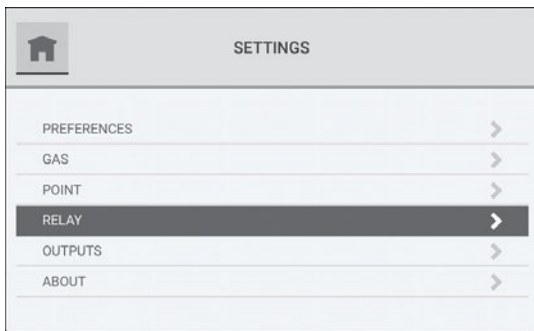

While the configuration is being updated, a **Busy** message shows at the bottom of the **Configure Relays** screen.



If the or button is selected while the **Busy** message shows, a pop-up asks whether to abandon the configuration changes.

- To return to the **Configure Relays** screen without saving the changes, select **Return without Saving**.
- To save the changes and return to the **Configure Relay** screen, select **Save and Return**.

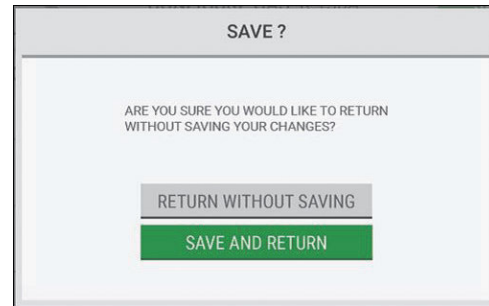

When the configuration changes have been saved, the **Settings** screen shows.

Communications Output

Use the **Outputs** option to change the configuration settings for digital and analog outputs.

Except for the buttons that show in the screen headers, the screens and steps used to change the output settings are the same as those used during the initial setup.

During the initial setup, the screen headers show the **NEXT** and buttons. During routine operation, the screen headers show the , , and **SAVE** buttons.

When a change is made to the configuration, the **Save** button becomes active.

On the **Settings** screen, select **Outputs**.

To adjust the output configuration settings, go to “[Communications Output](#),” p. 21, and do [Step 1.](#) to [Step 3.](#)

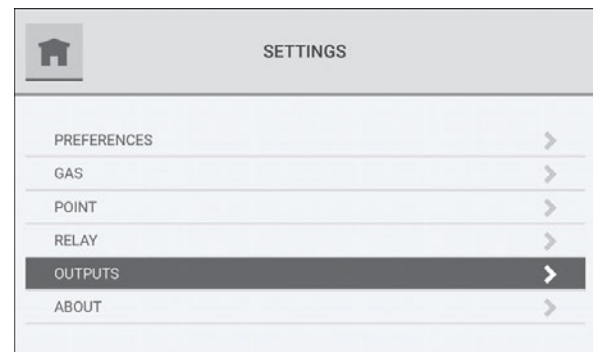

While the configuration is being updated, a **Busy** message shows at the bottom of the **Outputs** screen.

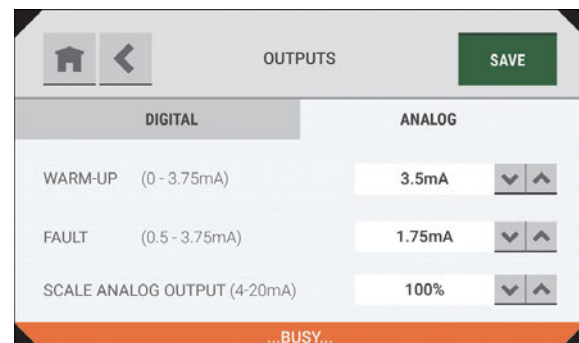

Routine Operation

If the or button is selected while the **Busy** message shows, a pop-up asks whether to abandon the configuration changes.

- To return to the **Outputs** screen without saving the changes, select **Return without Saving**.
- To save the changes and return to the **Outputs** screen, select **Save and Return**.

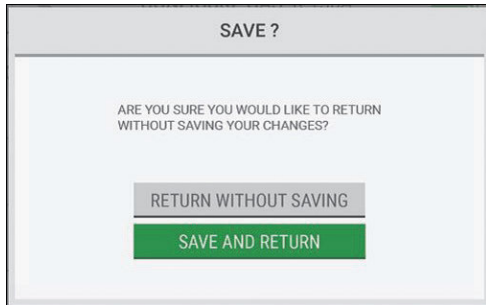

When the configuration changes have been saved, the **Settings** screen shows.

About

The **About** option shows information about the device and its component parts.

On the **Settings** screen, select **About**.

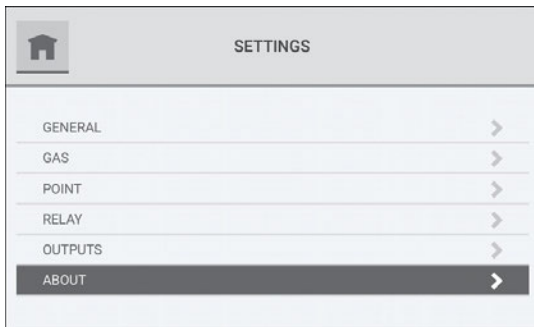

Use the scroll bar to see all of the available information.

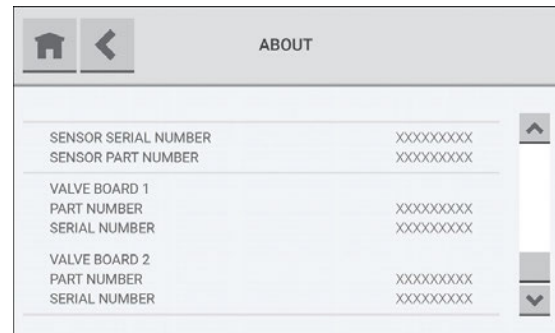

Diagnostics

If the date setting is changed after the initial set up configuration, the predictive maintenance logs will need to be reset on each graph to ensure accuracy.

When a predictive warning, fault, or alarm is acknowledged, a notification shows on the **Diagnostics** button on the dashboard.

1. On the dashboard, select the Diagnostics button.



Flow Diagnostics

1. On the Diagnostics screen, select Flow Diagnostics.

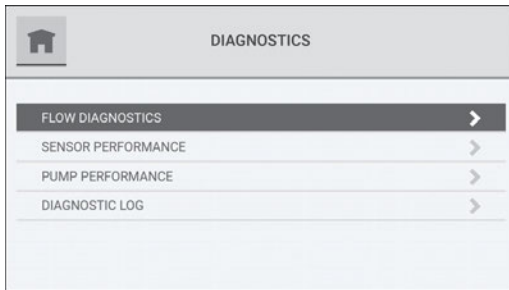

The **Flow Diagnostics** screen shows data for four points. If more than four points are enabled, additional tabs show the points in groups of four.

The flow rate for each point shows below the point name.

A directional arrow indicates the trending behavior of the flow rate for a point. The arrow is green only when the trend is static. The arrow is gray in other situations because a positive or negative trend indicates a change in the system.

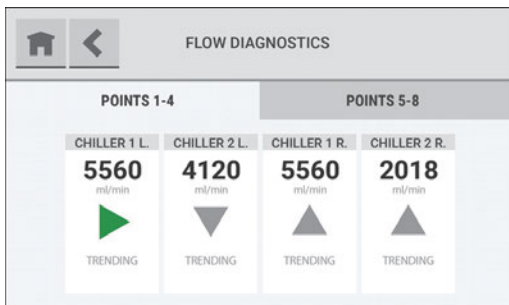

To see a detailed graph of the flow data for a point over time, select the point tile.

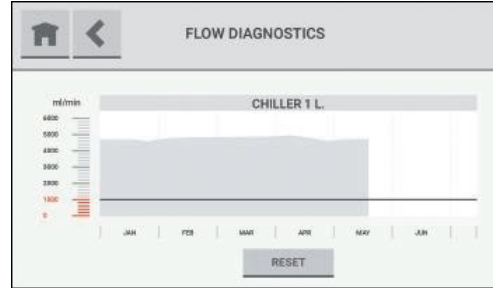

The background of point tiles associated with a predictive warning is yellow.

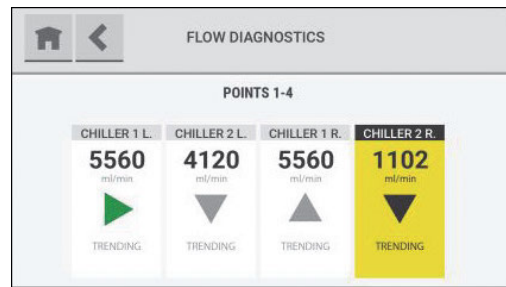

The background of point tiles associated with an alarm is red.

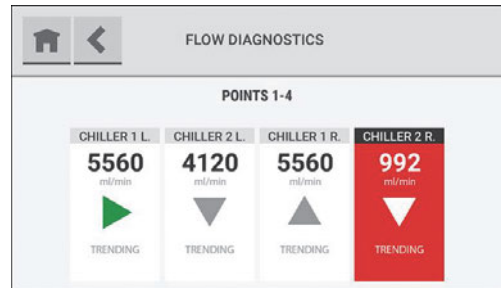

Values below the predictive warning threshold show in yellow.

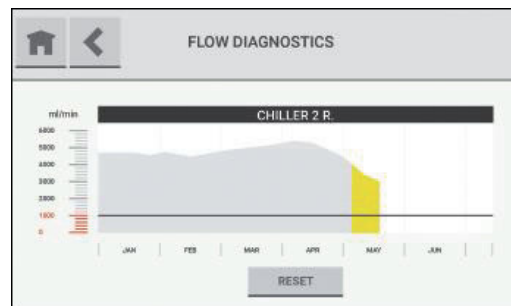

Values below the alarm threshold show in red.

To reset the flow diagnostics baseline, select **Reset**.

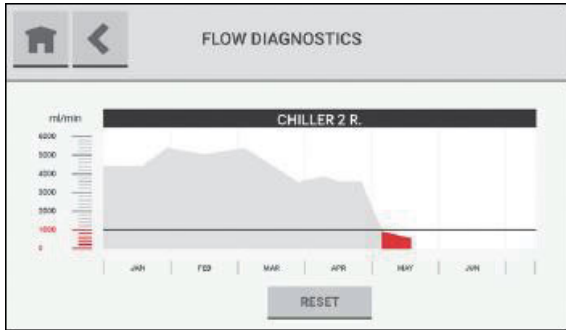

In the Warning pop-up, select **Reset** to continue the reset function or **Cancel** to cancel it.

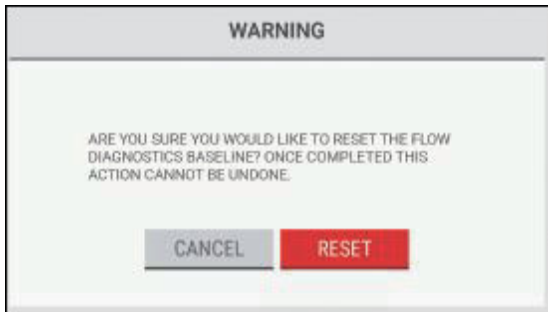

To see details about sensor performance, select the text box.



Sensor Performance

1. On the dashboard, select the Diagnostics button.
2. On the Diagnostics screen, select **Sensor Performance**.

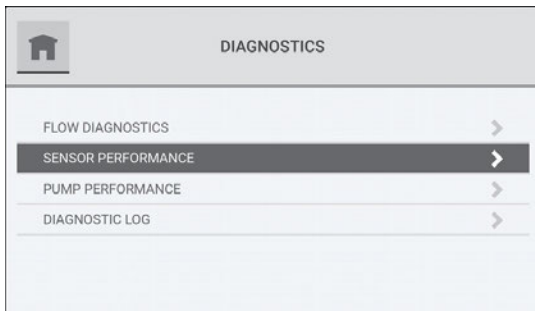

The **Sensor Performance** screen shows a graph of sensor performance over a 6month interval. The graph is divided into quadrants. Each quadrant indicates a particular sensor status.

The top left quadrant is associated with normal performance.

The bottom left and top right quadrants show predictive warnings in yellow. When the highlighted section shows below the trend line, it identifies the Poor threshold.

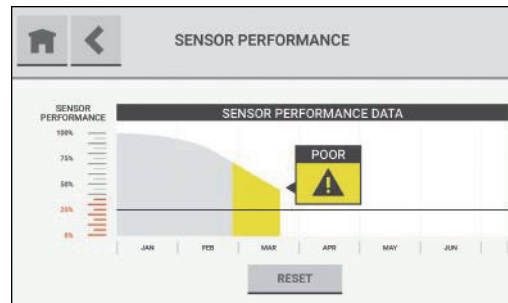

To see details about sensor performance in this quadrant, select the text box.

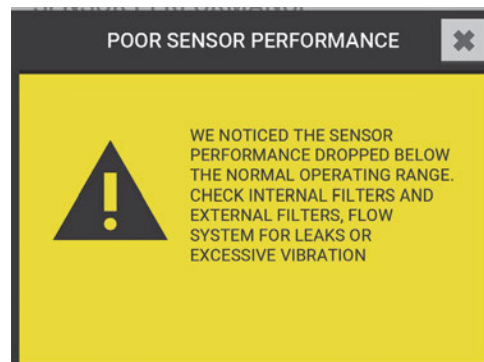

The bottom right quadrant shows predictive warnings in red. When the highlighted section shows below the trend line, it identifies the Poor threshold.

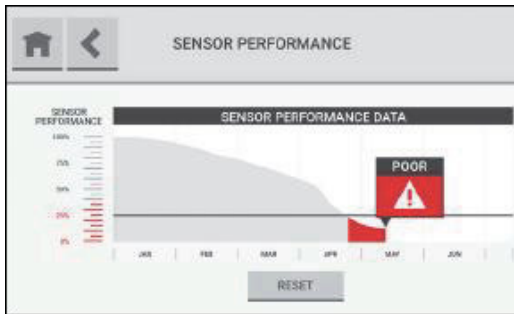

To see details about sensor performance in this quadrant, select the text box.

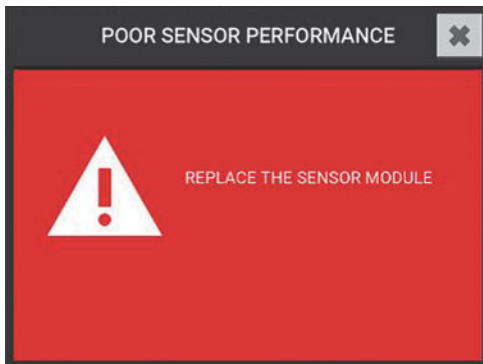

To reset the sensor performance baseline, select **Reset**.

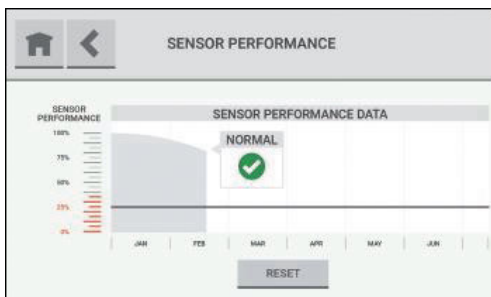

In the Warning pop-up, select **Reset** to continue the reset function or **Cancel** to cancel it.

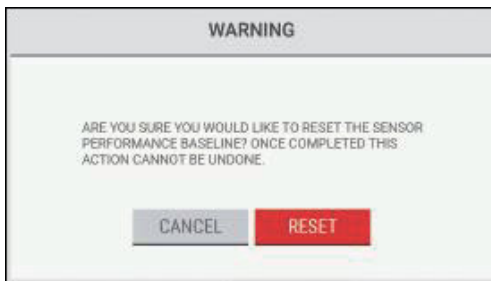

Pump Performance

1. On the dashboard, select the Diagnostics button.
2. On the **Diagnostics** screen, select **Pump Performance**.

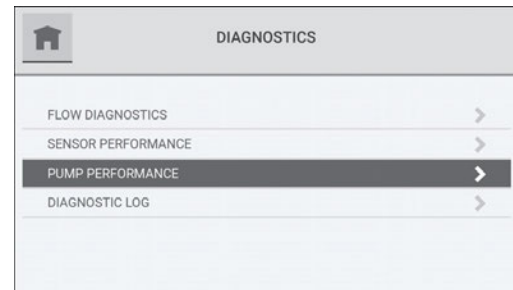

The **Pump Performance** screen shows a graph that plots pump performance over time.

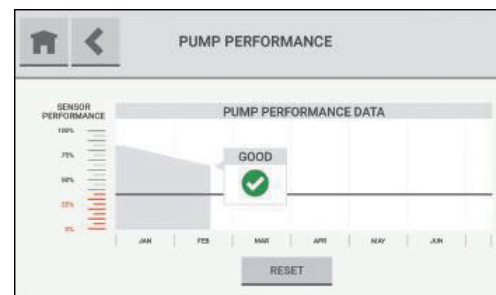

To see details about pump performance, select the text box.

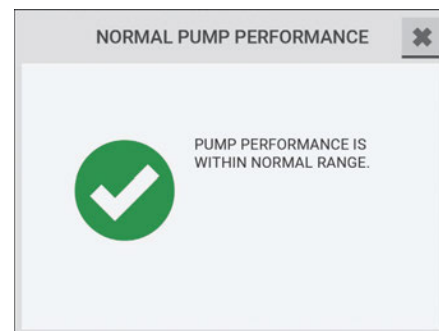

To reset the pump performance baseline, select **Reset**.

In the Warning pop-up, select **Reset** to continue the reset function or **Cancel** to cancel it.



The region of the graph that is below the predictive warning threshold shows in yellow or red, depending on the severity of the performance degradation. To see details about pump performance, select the text box.

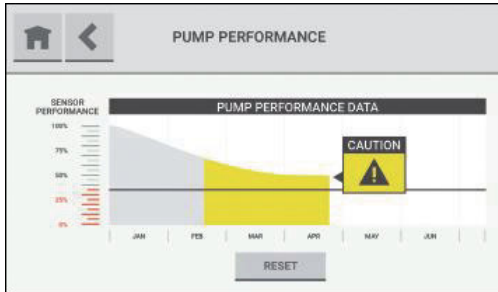

POOR PUMP PERFORMANCE

WE NOTICED THE PUMP PERFORMANCE DROPPED BELOW THE NORMAL OPERATING RANGE.

ACKNOWLEDGE



POOR PUMP PERFORMANCE

REPLACE THE PUMP MODULE.

Errors

Errors are events that do not result in a fault condition but that may impact the general performance of the device.

A notification of the event shows on the **Diagnostics** screen. For information about diagnostics, see “Diagnostics,” p. 39.

A notification shows on the **Diagnostics** button on the dashboard until the error is resolved.

1. On the dashboard, select the **Diagnostics** button.
2. On the **Diagnostics** screen, select **Diagnostic Log**.

A list shows the device errors.

If there are multiple errors, use the scroll bar to move through the list of events.

To see details about an error, select it.

Maintenance

Obey the following warnings and cautions for all maintenance procedures.

NOTICE

Electrostatic Discharge!

Electrostatic discharge can short equipment circuitry. Ensure that you are properly grounded before handling sensitive electronic equipment.

Under routine operating conditions, the device requires the following scheduled maintenance procedures:

- Examine and replace end-of-line filters
- Examine and replace internal inline filters

Scheduled Maintenance

Examine and Replace End-of-Line Filters

⚠ WARNING

Hazardous Service Procedures!

Failure to follow all precautions in this manual and on the tags, stickers, and labels could result in death or serious injury.

Technicians, in order to protect themselves from potential electrical, mechanical, and chemical hazards, **MUST** follow precautions in this manual and on the tags, stickers, and labels, as well as the following instructions: Unless specified otherwise, disconnect all electrical power including remote disconnect and discharge all energy storing devices such as capacitors before servicing. Follow proper lockout/tagout procedures to ensure the power can not be inadvertently energized. When necessary to work with live electrical components, have a qualified licensed electrician or other individual who has been trained in handling live electrical components perform these tasks.

⚠ WARNING

Risk of Asphyxiation!

Failure to follow instruction below could cause inaccurate readings and improper gas monitoring which could result in death or serious injury. Install and properly maintain end-of-line filters.

Examine the end-of-line filters periodically for dirt and particulate buildup.

Replace dirty filters when necessary. For a list of approved parts and how to order them, see “Ordering Information,” p. 49.

If an end-of-line filter becomes severely clogged with particulates, the flow rate for that sample line will decrease and eventually cause a flow rate fault.

Do the following procedure to replace an end-of-line filter:

1. Disconnect the dirty filter from the sample line tubing.
2. Discard the dirty filter.
3. Remove the new end-of-line filter from the bag.
4. Slide the end of the end-of-line filter with flexible tubing onto the sample line tubing. Make sure the arrow on the body of the filter points in the direction of air flow into the sample line.



Examine and Replace Internal Inline Filters

Inline filters are installed inside the device enclosure (see the following figure).

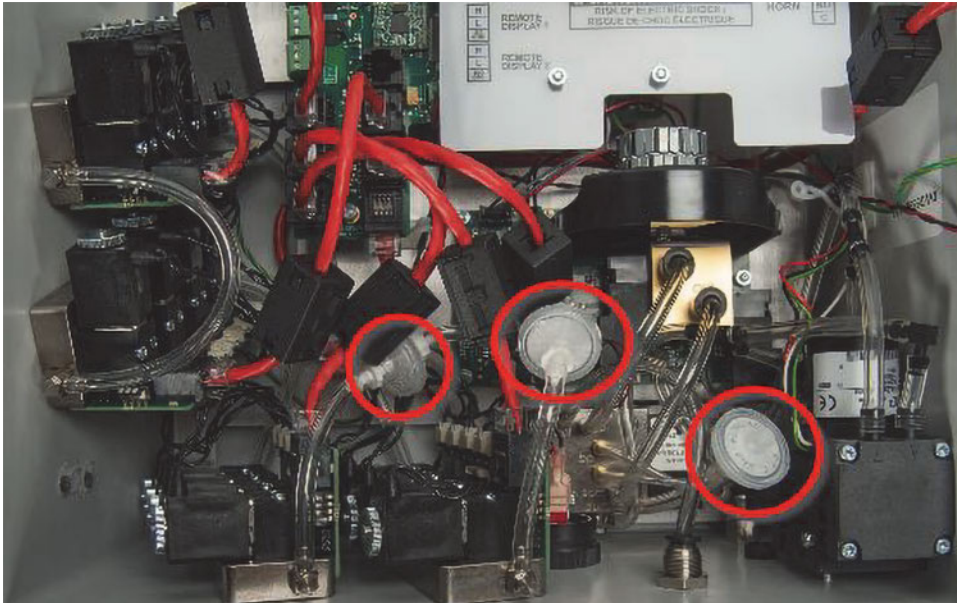
Figure 13. Location of inline filters

Periodically examine the inline filters inside the device enclosure for dirt and particulate buildup.

If the inline filters become severely clogged with particles or moisture, the flow rate for the device will decrease and eventually cause a flow fault.

Replace dirty filters when necessary to prevent damage to internal components. For a list of approved parts and how to order them, see “[Ordering Information](#),” p. 49.

Do the following procedure to replace the inline filters:

⚠ WARNING

Hazardous Voltage!

Failure to disconnect power before servicing could result in death or serious injury.

Disconnect all electric power, including remote disconnects before servicing. Follow proper lockout/tagout procedures to ensure the power cannot be inadvertently energized. Verify that no power is present with a voltmeter. To prevent electrical shock, confirm the circuit board cover is in place prior to powering unit.

1. Disconnect electrical power to the device.
2. If applicable, remove the locking mechanism.
3. Release the two latches on the left side of the device.
4. Open the enclosure.
5. Attach the ESD wrist strap to the ESD connection point inside the enclosure.
6. Twist the Luer locks on both ends of the inline filter to release the filter from the tubing.
7. Discard the dirty filter.
8. Remove the new inline filter from the bag.

9. Install one end of the new filter into the Luer lock and twist to lock the filter in position.
10. Twist the free end of tubing slightly so that it will be straight when it's connected to the filter.
11. Install the free end of the new filter into the Luer lock on the free end of tubing and twist to lock the filter in position.
12. Make sure the new filter fits snugly into both ends of the tubing.
13. Disconnect the ESD wrist strap from the ESD connection point inside the enclosure.
14. Close the enclosure.
15. Latch the two latches.
16. If applicable, attach the locking mechanism.
17. Supply electrical power to the device.

Replace Fuses

The device uses 2 amp, 240 V fuses (Trane P/N FUS02537 or an equivalent certified fuse).

Figure 14. Location of fuses

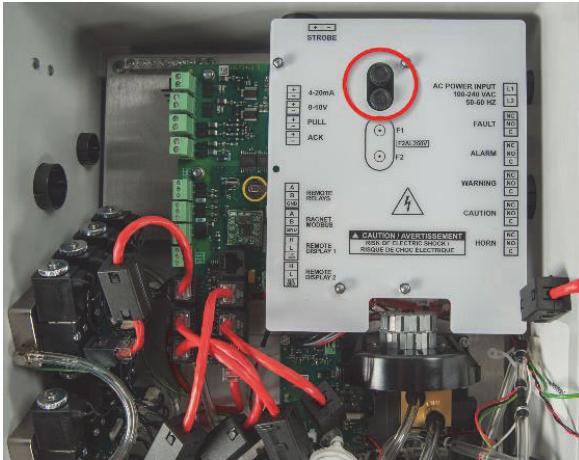

For a list of approved parts and how to order them, see “Ordering Information,” p. 49.

When necessary, do the following procedure to replace the fuses inside the device enclosure:

⚠ WARNING

Hazardous Voltage!

Failure to disconnect power before servicing could result in death or serious injury.

Disconnect all electric power, including remote disconnects before servicing. Follow proper lockout/tagout procedures to ensure the power cannot be inadvertently energized. Verify that no power is present with a voltmeter. To prevent electrical shock, confirm the circuit board cover is in place prior to powering unit.

1. Disconnect electrical power to the device.
2. If applicable, remove the locking mechanism.
3. Release the two latches on the left side of the device.
4. Open the enclosure.
5. Attach the ESD wrist strap to the ESD connection point inside the enclosure.
6. Turn the top of the fuse holder counterclockwise and remove it.
7. Remove the defective fuse.
8. Install a new fuse. Only use Trane P/N FUS02537 or an equivalent certified fuse.
9. Install the fuse holder and turn the top clockwise to secure it.
10. Disconnect the ESD wrist strap from the ESD connection point inside the enclosure.
11. Close the enclosure.
12. Latch the two latches.
13. If applicable, attach the locking mechanism.
14. Supply electrical power to the device.



Cleaning

Touchscreen Display

NOTICE

Equipment Damage!

Failure to follow instruction below could result in equipment damage.

Use only approved cleaning materials to prevent optical impairment of the display and/or device damage.

Use a soft lint-free cloth. The cloth can be dry or lightly dampened with a mild detergent. The detergent must have neutral pH. Do not use acidic or alkaline cleaners, or organic chemicals such as paint thinner, acetone, toluene, xylene, propyl or isopropyl alcohol, or kerosene.

Enclosure

Use a soft lint-free cloth. The cloth can be dry or lightly dampened with a mild detergent.



Technical Data

Technical Specifications/ Equipment Ratings

Usage	Indoor use only	
Overvoltage	Category II	
Pollution	Degree 2	
AC Power	100 to 240 Vac, 50/60 Hz, 200 VA maximum Supply voltage not to fluctuate more than $\pm 10\%$	
Operating Temperature	32°F to 122°F (0°C to 50°C)	
Operating Altitude Limit	9762 ft. (2975 m)	
Operating Humidity	0 to 95%, noncondensing	
Ingress Protection	IP54	
Size	Height x Width x Depth = 15.6 in. x 13.6 in. x 7.6 in. (39.6 cm x 34.5 cm x 19.3 cm)	
Weight	4 point unit = 14 lb (6.4 kg) 8 point unit = 15 lb (6.8 kg) 16 point = 17 lb (7.7 kg)	
Sensor Type	Photoacoustic Infrared	
Sample Line Tubing	1/4 in. OD x 1/8 in. ID 6 mm OD x 4 mm ID	Polyurethane (ether based) or metal with tubing
Sample Line Length	Up to 400 ft. (121 m) for optimum performance, will support up to 1200 ft. (366 m)	
Gases	R-11, R-12, R-22, R-123, R-134A, R-401A, R-404A, R-407A, R-407C, R-407F, R-410A, R-422A, R-422D, R-427A, R-507, R-1233zd(E), R-1234yf, R-1234ze, R-513A, R-514A	
Measuring Range	0–1000 ppm	
Sensitivity (minimum detection)	1 ppm for all listed gases	
Accuracy (linearity)	0–50 ppm ± 1 ppm, 51–1000 ppm $\pm 10\%$ of reading	
Sensor Response Time	90% of gas reading <70 sec	
Relays	5 Form C, 8A 250 Vac resistive SPDT	
Audible Alarm	95 ± 5 dB(A) at 24 in. (61 cm) maximum	
Communication Outputs	4–20 mA sourcing, 250 Ohm load; 0–10 V, 2 K Ohm minimum load; RS-485 Modbus RTU; RS-485 BACnet MS/TP	

Gas Reading Accuracy

Gas	Gas Concentration	Gas Reading Accuracy
As factory calibrated: R-134A, R-404A, R-410A, R-407C, R-123, R1233zd(E)	1–50 ppm 51–1000 ppm	± 1 ppm $\pm 10\%$ of F.S.
As factory calibrated extended library: R-11, R-12, R-1234ze, R-22, R-407F, R-401A, R-407A, R-422A, R-422D, R-427A, R-507, R-1234yf, R513A, R-514A	1–50 ppm 51–1000 ppm	± 3 ppm $\pm 30\%$ of reading
As calibrated after installation: R-134A, R-404A, R-410A, R-407C, R-123, R1233zd(E), R-11, R-12, R-1234ze, R-22, R-407F, R-401A, R-407A, R-422A, R-422D, R-427A, R-507, R-1234yf, R-513A, R-514A	1–50 ppm 51–1000 ppm	± 1 ppm $\pm 10\%$ of F.S.



Troubleshooting Guidelines

⚠ WARNING

Hazardous Voltage!

Failure to disconnect power before servicing could result in death or serious injury.

Disconnect all electric power, including remote disconnects before servicing. Follow proper lockout/tagout procedures to ensure the power cannot be inadvertently energized. Verify that no power is present with a voltmeter. To prevent electrical shock, confirm the circuit board cover is in place prior to powering unit.

NOTICE

Electrostatic Discharge!

Electrostatic discharge can short equipment circuitry. Ensure that you are properly grounded before handling sensitive electronic equipment.

Device will not turn on.

1. Make sure AC power is supplied to the device.
2. Make sure AC power to the device is wired correctly.
3. Make sure there are no loose wires on the AC inlet terminal block.
4. Check fuses F1 and F2. Replace them if necessary.

Strobe will not signal during an alarm event.

1. Check the user settings for strobe activation. See the [“Gas Configuration,” p. 34.](#)
2. Make sure the strobe wires are connected to the strobe connector.
3. Contact Trane Customer Service.

Internal buzzer will not signal during an alarm event.

1. Check the user settings for buzzer/horn activation. See the [“Gas Configuration,” p. 34.](#)
2. Make sure the buzzer wires are connected to the buzzer connector.
3. Contact Trane Customer Service.

Relays are not operating.

1. Check the user settings for the relays. See the [“Relay Configuration,” p. 37.](#)
2. Test the relay. See the [“Relay Configuration,” p. 37.](#)
3. Contact Trane Customer Service.

No analog communication output.

1. Check the user settings for communications. See the [“Communications Output,” p. 37](#)
2. Make sure the wire connections are correct.
3. Contact Trane Customer Service.

No digital communication output.

1. Check the user settings for communications. [“Communications Output,” p. 37.](#)
2. Make sure the wire connections are correct.
3. Contact Trane Customer Service.



Ordering Information

To obtain replacement parts, please contact your local Trane Parts and Supply store or visit www.tranesupply.com.

Replacement Parts

⚠ WARNING

Refrigerant Vapor Hazard!
 Failure to follow instructions below could result in death or serious injury.
 Refrigerant or other gases could displace available oxygen, causing possible asphyxiation or other serious health risks. Some gases may be flammable and/or explosive.

- Use only genuine Trane replacement parts when performing maintenance procedures.
- Do not repair or alter the device beyond the scope of these maintenance instructions.
- Repairs must be performed by authorized Trane service personnel ONLY.

Figure 15. Replacement parts identifier

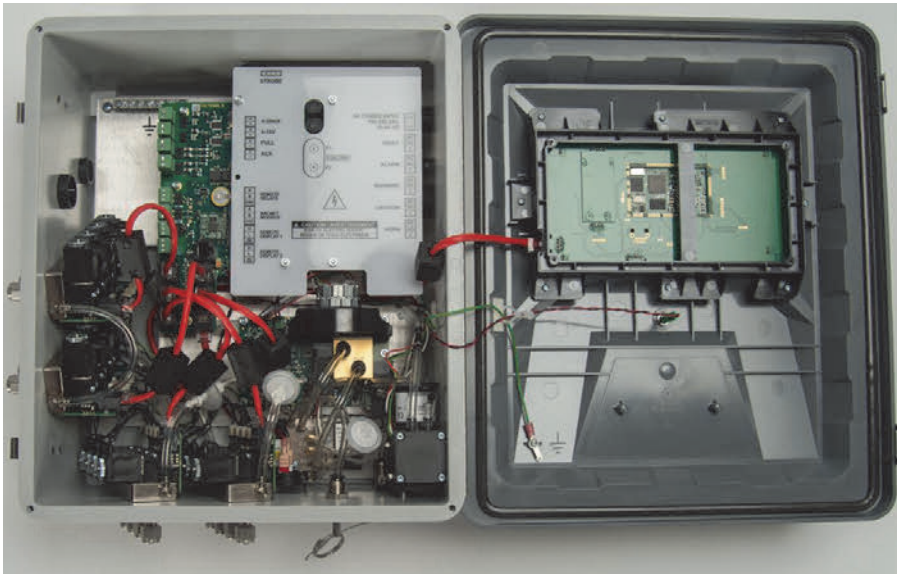

TRANE Part Number	Part Description
Replacement Parts	
FLR04743	END OF LINE FILTER PACK OF 4
FLR01881	INLINE FILTER
FUS02537	2.0 AMP, 250 V Fuse
KIT18294	PHOENIX TERMINAL KIT
LIT0882	RED STROBE
Installation and Calibration	
TUB10602	TUBE; 1/8 ID X 1/4 OD X 1 FT, CLEAR POLYURETHANE
FLR01404	FILTER, SCRUBBER, ZERO GAS
TOL00170	TOOL; CALIBRATION KIT, LESS REFRIGERANT CANISTER PUMPED SENSORS



Ordering Information

TRANE Part Number	Part Description
REG00618	REGULATOR; CALIBRATION DEMAND
Calibration Gas Cylinders	
TOL00175	CHARGED CANISTER, COMPRESSED DRY NITROGEN
TOL00171	CHARGED CANISTER, CFC-11, 30 PPM
TOL00173	CHARGED CANISTER, HCFC-123, 30 PPM
TOL00416	CHARGED CANISTER, HCFC-123, 50 PPM
TOL02848	CHARGED CANISTER, HCFC-123, 100 PPM
TOL00174	CHARGED CANISTER, HFC-134A, 30 PPM
TOL03901	CHARGED CANISTER; HFC-134A; 100 PPM
TOL00172	CHARGED CANISTER, HCFC-22, 30 PPM
TOL03216	CHARGED CANISTER, HCFC-22, 100 PPM
TOL04038	CHARGED CANISTER, R410A, 100 PPM
TOL03913	CHARGED CANISTER, R407C, 100 PPM
TOL00196	CHARGED CANISTER, CFC-113, 30 PPM
Accessories	
ALM00007	ALARM; EXTERNAL HORN
ALM00019	ALARM; EXTERNAL SILENCING STATION
ALM00020	ALARM; EXTERNAL ACTIVATION
KIT18293	KIT; MAINTENANCE



Appendix A: Start-up Check List

Before applying power to the TruSense™ RMWH Refrigerant Monitor, check for all items in the following table:

Item	Check for	Examiner's Initials
1	Proper mounting: Indoors on a rigid surface that does not have vibration or mechanical shock In a vertical position approximately 5 ft. (1.5 m) off the ground Away from direct solar heating or other excessive heat sources, wet or damp conditions where condensation can occur, areas that are dirty or exposed to oils or chemicals, areas where explosive concentrations of combustible gases or vapors can occur	
2	Correct electrical connections and wiring: Correct voltage: 100–240 Vac, 50/60 Hz, 200 VA maximum Through a dedicated circuit breaker Approved three-conductor wire (minimum 16 AWG), rated 300 Vac at 221°F (105°C) Conduit hubs and hardware that are suitable for fiberglass enclosures	
3	Correct tubing for sample lines	
4	End-of-line filters installed in sample lines	
5	No end-of-line filter installed in exhaust line	
6	All caps and plugs at sample line inlets and exhaust port removed	
7	Unused sampling ports are disabled	
8	Correct calibration kit and check gases for calibration are available	
9	Proper exhaust venting to one of the following (outside atmosphere preferred): Outside atmosphere, end of exhaust tube protected from debris collection Safe indoor area away from personnel and refrigerant gases	

Appendix B: Installation of Optional Equipment

NOTICE

Electrostatic Discharge!

Electrostatic discharge can short equipment circuitry. Ensure that you are properly grounded before handling sensitive electronic equipment.

Strobe

Figure 16. Strobe wiring

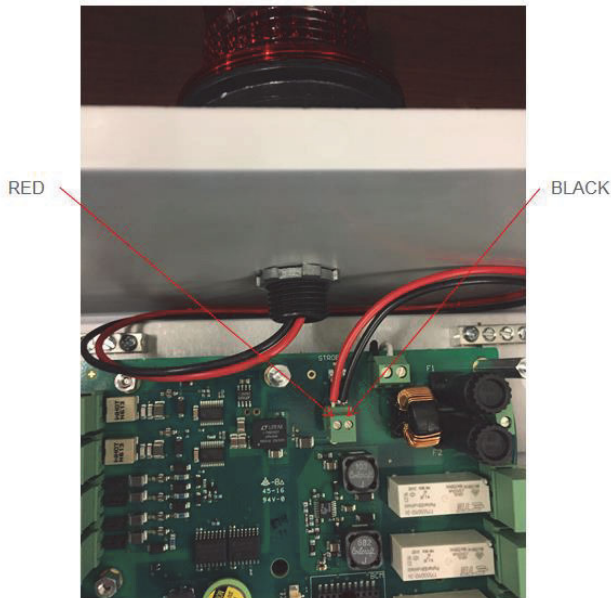

For field installations, follow the strobe manufacturer's instructions and the following general procedure:

⚠ WARNING

Hazardous Voltage!

Failure to disconnect power before servicing could result in death or serious injury. Disconnect all electric power, including remote disconnects before servicing. Follow proper lockout/tagout procedures to ensure the power cannot be inadvertently energized. Verify that no power is present with a voltmeter. To prevent electrical shock, confirm the circuit board cover is in place prior to powering unit.

1. Disconnect electrical power to the device.
2. If applicable, remove the locking mechanism.
3. Release the two latches on the left side of the device.
4. Open the enclosure.
5. Attach the ESD wrist strap to the ESD connection point inside the enclosure.

6. Use a 1/4-inch hex driver to remove the four hex nuts on the circuit board cover.
7. Remove the circuit board cover.
8. Remove the hole plug out of the top of the device.
9. Put the wires of the strobe through the middle of the supplied gasket.
10. Put the wires through the hole in the top of the enclosure and the supplied locknut.
11. Tighten the locknut so the strobe is attached securely to the device.
12. Insert the wires for the strobe into the Phoenix connector on the circuit board marked **STROBE**. Make sure each wire is inserted into the correct connector terminal.
13. Use a small flathead screwdriver to tighten the screws on the Phoenix connector and secure the wires.
14. Install the circuit board cover.
15. Use a 1/4-inch hex driver to install the four hex nuts on the circuit board cover.
16. Disconnect the ESD wrist strap from the ESD connection point inside the enclosure.
17. Close the enclosure.
18. Latch the two latches.
19. If applicable, attach the locking mechanism.
20. Supply electrical power to the device.

External Horn

For field installations, follow the horn manufacturer's instructions and the following general procedure:

⚠ WARNING

Hazardous Voltage!

Failure to disconnect power before servicing could result in death or serious injury. Disconnect all electric power, including remote disconnects before servicing. Follow proper lockout/tagout procedures to ensure the power cannot be inadvertently energized. Verify that no power is present with a voltmeter. To prevent electrical shock, confirm the circuit board cover is in place prior to powering unit.

1. Disconnect electrical power to the device.
2. If applicable, remove the locking mechanism.
3. Release the two latches on the left side of the device.
4. Open the enclosure.
5. Attach the ESD wrist strap to the ESD connection point inside the enclosure.
6. Mount the horn 7 to 12 ft. (2 to 4 m) above the floor.

Appendix B: Installation of Optional Equipment

7. Use a ¼-inch hex driver to remove the four hex nuts on the circuit board cover.
8. Remove the circuit board cover.
9. Follow the wiring instructions supplied with the remote horn.
10. Insert the wires for the remote horn into the Phoenix connector marked **HORN** on the circuit board. Make sure each wire is inserted into the correct connector terminal:
 - a. For a normally de-energized relay, connect the wires to the **C** and **NO** terminals.
 - b. For a normally energized relay, connect the wires to the **C** and **NC** terminals.
11. Use a small flathead screwdriver to tighten the screws on the Phoenix connector and secure the wires.
12. Install the circuit board cover.
13. Use a 1/4-inch hex driver to install the four hex nuts on the circuit board cover.
14. Disconnect the ESD wrist strap from the ESD connection point inside the enclosure.
15. Close the enclosure.
16. Latch the two latches.
17. If applicable, attach the locking mechanism.
18. Supply electrical power to the device.

External Alarm Activation Station

⚠ WARNING

Hazardous Voltage!

Failure to disconnect power before servicing could result in death or serious injury. Disconnect all electric power, including remote disconnects before servicing. Follow proper lockout/tagout procedures to ensure the power cannot be inadvertently energized. Verify that no power is present with a voltmeter. To prevent electrical shock, confirm the circuit board cover is in place prior to powering unit.

1. Disconnect electrical power to the device.
2. If applicable, remove the locking mechanism.
3. Release the two latches on the left side of the device.
4. Open the enclosure.
5. Attach the ESD wrist strap to the ESD connection point inside the enclosure.
6. Follow the wiring instructions supplied with the alarm activation station.

7. Insert the wires for the alarm activation station into the Phoenix connector marked **PULL** on the circuit board. Make sure the wires are inserted correctly.
8. Use a small flathead screwdriver to tighten the screws on the Phoenix connector and secure the wires.
9. Disconnect the ESD wrist strap from the ESD connection point inside the enclosure.
10. Close the enclosure.
11. Latch the two latches.
12. If applicable, attach the locking mechanism.
13. Supply electrical power to the device.

External Alarm Silencing Station

⚠ WARNING

Hazardous Voltage!

Failure to disconnect power before servicing could result in death or serious injury. Disconnect all electric power, including remote disconnects before servicing. Follow proper lockout/tagout procedures to ensure the power cannot be inadvertently energized. Verify that no power is present with a voltmeter. To prevent electrical shock, confirm the circuit board cover is in place prior to powering unit.

1. Disconnect electrical power to the device.
2. If applicable, remove the locking mechanism.
3. Release the two latches on the left side of the device.
4. Open the enclosure.
5. Attach the ESD wrist strap to the ESD connection point inside the enclosure.
6. Follow the wiring instructions supplied with the alarm silencing station.
7. Insert the wires for the alarm silencing station to the Phoenix connector marked **ACK** on the circuit board. Make sure each wire is inserted into the correct connector terminal.
8. Use a small flathead screwdriver to tighten the screws on the Phoenix connector and secure the wires.
9. Disconnect the ESD wrist strap from the ESD connection point inside the enclosure.
10. Close the enclosure.
11. Latch the two latches.
12. If applicable, attach the locking mechanism.
13. Supply electrical power to the device.



Appendix C: Default Settings

Alarm Setpoints

The default settings for the alarm setpoints are the following:

- 5, 20, and 50 percent of full-scale range, except for R123, which are 1, 2, and 5 percent of full-scale range
- Non-latching
- Horn and strobe (if applicable) enabled

Relays

The default setting for the internal fault relay is the energized state. All other relays (alarm, warning, caution, and horn) are set to de-energized.

Output

The default setting for digital output is None. The factory default settings for analog output are 3.5 mA for Warm-up and 2.0 mA for Fault.



Appendix D: MODBUS Holding Registers

TruSense RMWH Refrigerant Monitor—MODBUS RTU (Holding Registers)

Section	Register Name	Channel Number	Index	Property	Notes
General	Product ID	General	40001	Read	"CG"
	Firmware Version 1		40002	Read	Major(MSB:1b)/Minor(1b)
	Firmware Version 2		40003	Read	Build(2b)
	Reserved 4		40004	Read	0
	Reserved 5		40005	Read	0
	Reserved 6		40006	Read	0
	Unit Status		40007	Read	Refer to "Unit Status Flags," p. 57
	ACK button		40008	Write	ACK by writing 1 to it
	RESET button		40009	Write	Refer to "RESET Button Actions," p. 57
Channels	1 Gas Number	Channel 1	40010	Read	Refer to "Gas Types," p. 58
	1 Gas Conc.		40011	Read	ppm
	1 Status		40012	Read	Refer to "Channel Status Flags," p. 58
	1 Reserved		40013	Read	0
	2 Gas Number	Channel 2	40014	Read	Refer to "Gas Types," p. 58
	2 Gas Conc.		40015	Read	ppm
	2 Status		40016	Read	Refer to "Channel Status Flags," p. 58
	2 Reserved		40017	Read	0
	3 Gas Number	Channel 3	40018	Read	Refer to "Gas Types," p. 58
	3 Gas Conc.		40019	Read	ppm
	3 Status		40020	Read	Refer to "Channel Status Flags," p. 58
	3 Reserved		40021	Read	0
	4 Gas Number	Channel 4	40022	Read	Refer to "Gas Types," p. 58
	4 Gas Conc.		40023	Read	ppm
	4 Status		40024	Read	Refer to "Channel Status Flags," p. 58
	4 Reserved		40025	Read	0
	5 Gas Number	Channel 5	40026	Read	Refer to "Gas Types," p. 58
	5 Gas Conc.		40027	Read	ppm
	5 Status		40028	Read	Refer to "Channel Status Flags," p. 58
	5 Reserved		40029	Read	0
	6 Gas Number	Channel 6	40030	Read	Refer to "Gas Types," p. 58
	6 Gas Conc.		40031	Read	ppm
	6 Status		40032	Read	Refer to "Channel Status Flags," p. 58
	6 Reserved		40033	Read	0
	7 Gas Number	Channel 7	40034	Read	Refer to "Gas Types," p. 58
	7 Gas Conc.		40035	Read	ppm
	7 Status		40036	Read	Refer to "Channel Status Flags," p. 58
	7 Reserved		40037	Read	0



Appendix D: MODBUS Holding Registers

Section	Register Name	Channel Number	Index	Property	Notes
	8 Gas Number	Channel 8	40038	Read	Refer to "Gas Types," p. 58
	8 Gas Conc.		40039	Read	ppm
	8 Status		40040	Read	Refer to "Channel Status Flags," p. 58
	8 Reserved		40041	Read	0
	9 Gas Number	Channel 9	40042	Read	Refer to "Gas Types," p. 58
	9 Gas Conc.		40043	Read	ppm
	9 Status		40044	Read	Refer to "Channel Status Flags," p. 58
	9 Reserved		40045	Read	0
	10 Gas Number	Channel 10	40046	Read	Refer to "Gas Types," p. 58
	10 Gas Conc.		40047	Read	ppm
	10 Status		40048	Read	Refer to "Channel Status Flags," p. 58
	10 Reserved		40049	Read	0
	11 Gas Number	Channel 11	40050	Read	Refer to "Gas Types," p. 58
	11 Gas Conc.		40051	Read	ppm
	11 Status		40052	Read	Refer to "Channel Status Flags," p. 58
	11 Reserved		40053	Read	0
	12 Gas Number	Channel 12	40054	Read	Refer to "Gas Types," p. 58
	12 Gas Conc.		40055	Read	ppm
	12 Status		40056	Read	Refer to "Channel Status Flags," p. 58
	12 Reserved		40057	Read	0
	13 Gas Number	Channel 13	40058	Read	Refer to "Gas Types," p. 58
	13 Gas Conc.		40059	Read	ppm
	13 Status		40060	Read	Refer to "Channel Status Flags," p. 58
	13 Reserved		40061	Read	0
	14 Gas Number	Channel 14	40062	Read	Refer to "Gas Types," p. 58
	14 Gas Conc.		40063	Read	ppm
	14 Status		40064	Read	Refer to "Channel Status Flags," p. 58
	14 Reserved		40065	Read	0
	15 Gas Number	Channel 15	40066	Read	Refer to "Gas Types," p. 58
	15 Gas Conc.		40067	Read	ppm
	15 Status		40068	Read	Refer to "Channel Status Flags," p. 58
	15 Reserved		40069	Read	0
	16 Gas Number	Channel 16	40070	Read	Refer to "Gas Types," p. 58
	16 Gas Conc.		40071	Read	ppm
	16 Status		40072	Read	Refer to "Channel Status Flags," p. 58
	16 Reserved		40073	Read	0

Appendix D: MODBUS Holding Registers

Section	Register Name	Channel Number	Index	Property	Notes
Gases Calibration	Next Cal Time	Gases	40090	Read	In days from 1970
	Zero Cal Time		40091	Read	In days from 1970
	Span Cal Time #00		40092	Read	In days from 1970 – R-11
	Span Cal Time #01		40093	Read	In days from 1970 – R-12
	Span Cal Time #02		40094	Read	In days from 1970 – R-22
	Span Cal Time #03		40095	Read	In days from 1970 – R-123
	Span Cal Time #04		40096	Read	In days from 1970 – R-134A
	Span Cal Time #05		40097	Read	In days from 1970 – R-401A
	Span Cal Time #06		40098	Read	In days from 1970 – R-404A
	Span Cal Time #07		40099	Read	In days from 1970 – R-407A
	Span Cal Time #08		40100	Read	In days from 1970 – R-407C
	Span Cal Time #09		40101	Read	In days from 1970 – R-407F
	Span Cal Time #10		40102	Read	In days from 1970 – R-410A
	Span Cal Time #11		40103	Read	In days from 1970 – R-422A
	Span Cal Time #12		40104	Read	In days from 1970 – R-422D
	Span Cal Time #13		40105	Read	In days from 1970 – R-427A
	Span Cal Time #14		40106	Read	In days from 1970 – R-507
	Span Cal Time #15		40107	Read	In days from 1970 – R-513A
	Span Cal Time #16		40108	Read	In days from 1970 – R-514A
	Span Cal Time #17		40109	Read	In days from 1970 – R-1233zd(E)
Span Cal Time #18	40110	Read	In days from 1970 – R-1234yf		
Span Cal Time #19	40111	Read	In days from 1970 – R-1234ze		

RESET Button Actions

HiByte	LoByte	Description
0	channel#	Reset channel-specific alarms, channel#1-#16 = 0..15
0	255	Reset all channel-specific alarms
1	channel#	Reset channel-specific faults, channel#1-#16 = 0..15
1	255	Reset all channels-specific faults
2	255	Reset common faults
3	255	Reset all alarms and all faults

Unit Status Flags

Bit	Description
0x0001	Warm up Set if warm-up time is pending
0x0002	Operating Normal operating mode is set (after warm-up; not in calibration, fault, or alarm)
0x0004	Calibration Set if calibration is in progress
0x0008	Fault Set if failure is reported
0x0010	Alarm Set if C/W/A level is achieved
0xFFE0	— Reserved



Appendix D: MODBUS Holding Registers

Channel Status Flags

Bit	Description	
0x0001	Caution	Set if caution level is achieved
0x0002	Warning	Set if warning level is achieved
0x0004	Alarm	Set if alarm level is achieved
0x0008	Beacon	Set if C/W/A is set
0x0010	Horn	Set if any configured C/W/A is set and not acknowledged yet
0x0020	New	Set if any of C/W/A is set and not acknowledged yet
0x0040	Hold	Set if any of C/W/A is in hold state (acknowledged latching alarm below threshold)
0x0080	Fault	Set if failure is reported
0xFF00	—	Reserved

Gas Types

	Value	Name
Gases	0	R-11
	1	R-12
	2	R-22
	3	R-123
	4	R-134A
	5	R-401A
	6	R-404A
	7	R-407A
	8	R-407C
	9	R-407F
	10	R-410A
	11	R-422A
	12	R-422D
	13	R-427A
	14	R-507
	15	R-513A
	16	R-514A
	17	R-1233zd(E)
	18	R-1234yf
19	R-1234ze	



Appendix E: BACnet Objects

TruSense RMWH Refrigerant Monitor—BACnet

Section	Object Name	Channel Number	Object Type	Inst Number	Property	Notes
General	Product ID	General	Analog Input	1	Read	"CG"
	Firmware Version		Analog Input	2	Read	Build(MSB:2b)/Major(1b)/Minor(1b)
	Reserved 4		Analog Input	4	Read	0
	Reserved 5		Analog Input	5	Read	0
	Reserved 6		Analog Input	6	Read	0
	Unit Status		Analog Input	7	Read	Refer to "Unit Status Flags," p. 61
	ACK button		Analog Input	8	Write	ACK by writing 1 to it
	RESET button		Analog Input	9	Write	Refer to "RESET Button Actions," p. 61
	Channels		1 Gas Number	Channel 1	Analog Input	10
1 Gas Conc.		Analog Input	11		Read	ppm
1 Status		Analog Input	12		Read	Refer to "Channel Status Flags," p. 62
1 Reserved		Analog Input	13		Read	0
	2 Gas Number	Channel 2	Analog Input	14	Read	Refer to "Gas Types," p. 62
	2 Gas Conc.		Analog Input	15	Read	ppm
	2 Status		Analog Input	16	Read	Refer to "Channel Status Flags," p. 62
	2 Reserved		Analog Input	17	Read	0
	3 Gas Number	Channel 3	Analog Input	18	Read	Refer to "Gas Types," p. 62
	3 Gas Conc.		Analog Input	19	Read	ppm
	3 Status		Analog Input	20	Read	Refer to "Channel Status Flags," p. 62
	3 Reserved		Analog Input	21	Read	0
	4 Gas Number	Channel 4	Analog Input	22	Read	Refer to "Gas Types," p. 62
	4 Gas Conc.		Analog Input	23	Read	ppm
	4 Status		Analog Input	24	Read	Refer to "Channel Status Flags," p. 62
	4 Reserved		Analog Input	25	Read	0
	5 Gas Number	Channel 5	Analog Input	26	Read	Refer to "Gas Types," p. 62
	5 Gas Conc.		Analog Input	27	Read	ppm
	5 Status		Analog Input	28	Read	Refer to "Channel Status Flags," p. 62
	5 Reserved		Analog Input	29	Read	0
	6 Gas Number	Channel 6	Analog Input	30	Read	Refer to "Gas Types," p. 62
	6 Gas Conc.		Analog Input	31	Read	ppm
	6 Status		Analog Input	32	Read	Refer to "Channel Status Flags," p. 62
	6 Reserved		Analog Input	33	Read	0
	7 Gas Number	Channel 7	Analog Input	34	Read	Refer to "Gas Types," p. 62
	7 Gas Conc.		Analog Input	35	Read	ppm
	7 Status		Analog Input	36	Read	Refer to "Channel Status Flags," p. 62
	7 Reserved		Analog Input	37	Read	0



Appendix E: BACnet Objects

Section	Object Name	Channel Number	Object Type	Inst Number	Property	Notes
	8 Gas Number	Channel 8	Analog Input	38	Read	Refer to "Gas Types," p. 62
	8 Gas Conc.		Analog Input	39	Read	ppm
	8 Status		Analog Input	40	Read	Refer to "Channel Status Flags," p. 62
	8 Reserved		Analog Input	41	Read	0
	9 Gas Number	Channel 9	Analog Input	42	Read	Refer to "Gas Types," p. 62
	9 Gas Conc.		Analog Input	43	Read	ppm
	9 Status		Analog Input	44	Read	Refer to "Channel Status Flags," p. 62
	9 Reserved		Analog Input	45	Read	0
	10 Gas Number	Channel 10	Analog Input	46	Read	Refer to "Gas Types," p. 62
	10 Gas Conc.		Analog Input	47	Read	ppm
	10 Status		Analog Input	48	Read	Refer to "Channel Status Flags," p. 62
	10 Reserved		Analog Input	49	Read	0
	11 Gas Number	Channel 11	Analog Input	50	Read	Refer to "Gas Types," p. 62
	11 Gas Conc.		Analog Input	51	Read	ppm
	11 Status		Analog Input	52	Read	Refer to "Channel Status Flags," p. 62
	11 Reserved		Analog Input	53	Read	0
	12 Gas Number	Channel 12	Analog Input	54	Read	Refer to "Gas Types," p. 62
	12 Gas Conc.		Analog Input	55	Read	ppm
	12 Status		Analog Input	56	Read	Refer to "Channel Status Flags," p. 62
	12 Reserved		Analog Input	57	Read	0
	13 Gas Number	Channel 13	Analog Input	58	Read	Refer to "Gas Types," p. 62
	13 Gas Conc.		Analog Input	59	Read	ppm
	13 Status		Analog Input	60	Read	Refer to "Channel Status Flags," p. 62
	13 Reserved		Analog Input	61	Read	0
	14 Gas Number	Channel 14	Analog Input	62	Read	Refer to "Gas Types," p. 62
	14 Gas Conc.		Analog Input	63	Read	ppm
	14 Status		Analog Input	64	Read	Refer to "Channel Status Flags," p. 62
	14 Reserved		Analog Input	65	Read	0
	15 Gas Number	Channel 15	Analog Input	66	Read	Refer to "Gas Types," p. 62
	15 Gas Conc.		Analog Input	67	Read	ppm
	15 Status		Analog Input	68	Read	Refer to "Channel Status Flags," p. 62
	15 Reserved		Analog Input	69	Read	0
	16 Gas Number	Channel 16	Analog Input	70	Read	Refer to "Gas Types," p. 62
	16 Gas Conc.		Analog Input	71	Read	ppm
	16 Status		Analog Input	72	Read	Refer to "Channel Status Flags," p. 62
	16 Reserved		Analog Input	73	Read	0

Section	Object Name	Channel Number	Object Type	Inst Number	Property	Notes
Gases Calibration	Next Cal Time	Gases	Analog Input	90	Read	In days from 1970
	Zero Cal Time		Analog Input	91	Read	In days from 1970
	Span Cal Time #00		Analog Input	92	Read	In days from 1970 – R-11
	Span Cal Time #01		Analog Input	93	Read	In days from 1970 – R-12
	Span Cal Time #02		Analog Input	94	Read	In days from 1970 – R-22
	Span Cal Time #03		Analog Input	95	Read	In days from 1970 – R-123
	Span Cal Time #04		Analog Input	96	Read	In days from 1970 – R-134A
	Span Cal Time #05		Analog Input	97	Read	In days from 1970 – R-401A
	Span Cal Time #06		Analog Input	98	Read	In days from 1970 – R-404A
	Span Cal Time #07		Analog Input	99	Read	In days from 1970 – R-407A
	Span Cal Time #08		Analog Input	100	Read	In days from 1970 – R-407C
	Span Cal Time #09		Analog Input	101	Read	In days from 1970 – R-407F
	Span Cal Time #10		Analog Input	102	Read	In days from 1970 – R-410A
	Span Cal Time #11		Analog Input	103	Read	In days from 1970 – R-422A
	Span Cal Time #12		Analog Input	104	Read	In days from 1970 – R-422D
	Span Cal Time #13		Analog Input	105	Read	In days from 1970 – R-427A
	Span Cal Time #14		Analog Input	106	Read	In days from 1970 – R-507
	Span Cal Time #15		Analog Input	107	Read	In days from 1970 – R-513A
	Span Cal Time #16		Analog Input	108	Read	In days from 1970 – R-514A
	Span Cal Time #17		Analog Input	109	Read	In days from 1970 – R-1233zd(E)
Span Cal Time #18	Analog Input	110	Read	In days from 1970 – R-1234yf		
Span Cal Time #19	Analog Input	111	Read	In days from 1970 – R-1234ze		

RESET Button Actions

HiByte	LoByte	Description
0	channel#	Reset channel-specific alarms, channel#1-#16 = 0..15
0	255	Reset all channel-specific alarms
1	channel#	Reset channel-specific faults, channel#1-#16 = 0..15
1	255	Reset all channels-specific faults
2	255	Reset common faults
3	255	Reset all alarms and all faults

Unit Status Flags

Bit	Description	
0x0001	Warm up	Set if warm-up time is pending
0x0002	Operating	Normal operating mode is set (after warm-up; not in calibration, fault, or alarm)
0x0004	Calibration	Set if calibration is in progress
0x0008	Fault	Set if failure is reported
0x0010	Alarm	Set if C/W/A level is achieved
0xFFE0	—	Reserved



Appendix E: BACnet Objects

Channel Status Flags

Bit	Description	
0x0001	Caution	Set if caution level is achieved
0x0002	Warning	Set if warning level is achieved
0x0004	Alarm	Set if alarm level is achieved
0x0008	Beacon	Set if C/W/A is set
0x0010	Horn	Set if any configured C/W/A is set and not acknowledged yet
0x0020	New	Set if any of C/W/A is set and not acknowledged yet
0x0040	Hold	Set if any of C/W/A is in hold state (acknowledged latching alarm below threshold)
0x0080	Fault	Set if failure is reported
0xFF00	—	Reserved

Gas Types

	Value	Name
Gases	0	R-11
	1	R-12
	2	R-22
	3	R-123
	4	R-134A
	5	R-401A
	6	R-404A
	7	R-407A
	8	R-407C
	9	R-407F
	10	R-410A
	11	R-422A
	12	R-422D
	13	R-427A
	14	R-507
	15	R-513A
	16	R-514A
	17	R-1233zd(E)
	18	R-1234yf
19	R-1234ze	

Trane - by Trane Technologies (NYSE: TT), a global innovator - creates comfortable, energy efficient indoor environments for commercial and residential applications. For more information, please visit trane.com or tranetechnologies.com.

Trane has a policy of continuous product and product data improvements and reserves the right to change design and specifications without notice. We are committed to using environmentally conscious print practices.

PART-SVX008A-EN 30 Sep 2025
Supersedes RMWH-SVX001D-EN (June 2022)

©2025 Trane