



Installation, Operation, and Maintenance

Packaged Water-Cooled Magnetic Bearing Chiller

Model TACW



▲ SAFETY WARNING

Only qualified personnel should install and service the equipment. The installation, starting up, and servicing of heating, ventilating, and air-conditioning equipment can be hazardous and requires specific knowledge and training. Improperly installed, adjusted or altered equipment by an unqualified person could result in death or serious injury. When working on the equipment, observe all precautions in the literature and on the tags, stickers, and labels that are attached to the equipment.

February 2024

ARTC-SVX014A-EN

TRANE
TECHNOLOGIES™



Introduction

Read this manual thoroughly before operating or servicing this unit.

Warnings, Cautions, and Notices

Safety advisories appear throughout this manual as required. Your personal safety and the proper operation of this machine depend upon the strict observance of these precautions.

The three types of advisories are defined as follows:



Indicates a potentially hazardous situation which, if not avoided, could result in death or serious injury.



Indicates a potentially hazardous situation which, if not avoided, could result in minor or moderate injury. It could also be used to alert against unsafe practices.



Indicates a situation that could result in equipment or property-damage only accidents.

Important Environmental Concerns

Scientific research has shown that certain man-made chemicals can affect the earth's naturally occurring stratospheric ozone layer when released to the atmosphere. In particular, several of the identified chemicals that may affect the ozone layer are refrigerants that contain Chlorine, Fluorine and Carbon (CFCs) and those containing Hydrogen, Chlorine, Fluorine and Carbon (HCFCs). Not all refrigerants containing these compounds have the same potential impact to the environment. Trane advocates the responsible handling of all refrigerants.

Important Responsible Refrigerant Practices

Trane believes that responsible refrigerant practices are important to the environment, our customers, and the air conditioning industry. All technicians who handle refrigerants must be certified according to local rules. For the USA, the Federal Clean Air Act (Section 608) sets forth the requirements for handling, reclaiming, recovering and recycling of certain refrigerants and the equipment that is used in these service procedures. In addition, some states or municipalities may have additional requirements that must also be adhered to for responsible management of refrigerants. Know the applicable laws and follow them.

⚠ WARNING

Proper Field Wiring and Grounding Required!

Failure to follow code could result in death or serious injury.

All field wiring **MUST** be performed by qualified personnel. Improperly installed and grounded field wiring poses **FIRE** and **ELECTROCUTION** hazards. To avoid these hazards, you **MUST** follow requirements for field wiring installation and grounding as described in **NEC** and your local/state/national electrical codes.

⚠ WARNING

Personal Protective Equipment (PPE) Required!

Failure to wear proper PPE for the job being undertaken could result in death or serious injury.

Technicians, in order to protect themselves from potential electrical, mechanical, and chemical hazards, **MUST** follow precautions in this manual and on the tags, stickers, and labels, as well as the instructions below:

- **Before installing/servicing this unit, technicians MUST put on all PPE required for the work being undertaken (Examples; cut resistant gloves/sleeves, butyl gloves, safety glasses, hard hat/bump cap, fall protection, electrical PPE and arc flash clothing). ALWAYS refer to appropriate Safety Data Sheets (SDS) and OSHA guidelines for proper PPE.**
- **When working with or around hazardous chemicals, ALWAYS refer to the appropriate SDS and OSHA/GHS (Global Harmonized System of Classification and Labelling of Chemicals) guidelines for information on allowable personal exposure levels, proper respiratory protection and handling instructions.**
- **If there is a risk of energized electrical contact, arc, or flash, technicians MUST put on all PPE in accordance with OSHA, NFPA 70E, or other country-specific requirements for arc flash protection, PRIOR to servicing the unit. NEVER PERFORM ANY SWITCHING, DISCONNECTING, OR VOLTAGE TESTING WITHOUT PROPER ELECTRICAL PPE AND ARC FLASH CLOTHING. ENSURE ELECTRICAL METERS AND EQUIPMENT ARE PROPERLY RATED FOR INTENDED VOLTAGE.**

⚠ WARNING**Follow EHS Policies!**

Failure to follow instructions below could result in death or serious injury.

- **All Trane personnel must follow the company's Environmental, Health and Safety (EHS) policies when performing work such as hot work, electrical, fall protection, lockout/tagout, refrigerant handling, etc. Where local regulations are more stringent than these policies, those regulations supersede these policies.**
- **Non-Trane personnel should always follow local regulations.**

Copyright

This document and the information in it are the property of Trane, and may not be used or reproduced in whole or in part without written permission. Trane reserves the right to revise this publication at any time, and to make changes to its content without obligation to notify any person of such revision or change.

Trademarks

All trademarks referenced in this document are the trademarks of their respective owners.



Table of Contents

Model Number Descriptions	6	Connecting Module Power and Control	
Model Number and Coding	6	Wires	15
Chiller Model and Serial Numbers	6	Power Distribution Panel	15
Model Number	7	BMS Wiring	15
Model Coding Key	7	Hardwire Options	15
Chiller Description	8	Pre-Start up	16
Chiller Scope	8	Preparation for Initial Start-Up	16
Chiller Capacities	8	Operating Principles	17
System Description	8	Refrigeration Circuits	17
Standard Features	8	Refrigeration Cycle	17
Optional Features	8	Compressor	17
Component Specification	9	Operating Procedures	18
Compact Turbocor Compressor	9	Operator Interface	18
Flooded Shell and Tube Evaporator		Chiller Panels	18
and Condenser	9	Panel-Mounted Disconnect	
Refrigeration Components	9	Handle	19
Electrical	9	Controller and HMI	19
General Data	10	Operating the Microprocessor	19
Installation Mechanical	11	Microprocessor Functions	19
Inspect and Report Damage	11	Operator Control	19
Inspection of Delivered Equipment	11	Touchscreen Interface Tutorial – Control	
Warranty Issues	11	System	19
Long Term Storage Requirements	11	Control Architecture	20
Factory Preparation	11	Basic Controls	20
Customer Responsibilities	11	Special Functions	34
Handling of the Chillers	12	Optional Functionalities	53
Site Preparation and Clearances	12	Security Configuration	59
Chiller Clearances	12	Alarm Handling	60
Minimum Clearances	12	Operator Tasks	60
Service Access	12	Normal Power Up	60
Rigging, Lifting, and Moving the		Emergency Power Shutdown	61
Chiller	13	Water Quality Guidelines	61
Chiller Placement	13	Monitor Water Quality	61
Installation Piping	14	Maintain Glycol Level	62
Install Piping and External		Prevent Freezing	62
Components	14	Unit Controls	64
Initial Flushing of Piping	14	Chiller Controller	64
Fill with Water/Glycol Solution	14	Freeze Protection	64
Installation Electrical	15	Flow Switch	64
		Temperature Control	64
		Electronic Expansion Valves	64

Sequence of Operations	65	Timeout State	69
Main Sequence	65	Power Failure	69
Supplemental Sequences	65	Power Restore	69
Device Sequences	66	Fast Restart	69
Chiller Operational States	68	Maintenance Procedures	70
Idle State	68	Maintenance Strategy	70
Start State	68	Power Disconnect Handle	70
Operational State	68	Federal Clean Air Act	70
Stage-In State	68	Inspection and Maintenance Schedule	70
Restart State	68	Inspection Methods	70
Stage-out State	68	Maintenance Checklist	70
Shutdown State	68	Maintenance Schedule	71
Compressor Control States	69	Winter Shutdown Preparation	73
Absent State	69	Maintenance Tasks	73
Offline State	69	Critical Cleaning Tasks	73
Idle State	69	Compressor Tasks	74
Starting State	69	Chiller Troubleshooting	75
Operational State	69	Chiller in Alarm Avoidance	75
Stopping State	69	Alarms	75
Retreating State	69	Compressor Faults	75
Hold State	69		
Fault State	69		



Model Number Descriptions

Digit 1 — Brand

T = Trane

Digit 2, 3, 4 — Model Series

ACW = Water-Cooled

Digit 5, 6, 7 — Nominal Capacity

150 = 130 to 160 Tons

220 = 165 to 250 Tons

525 = 400 to 525 Tons

600 = 450 to 600 Tons

Digit 8 — Compressor Quantity

A = 1

B = 2

C = 3

D = 4

Digit 9, 10, 11 — Compressor Model

T30 = TTS300

T35 = TTS350

T40 = TTS400

T50 = TTS700

Digit 12 — Tube Passes (Evaporator)

1 = Single Pass

2 = Two Pass

3 = Three Pass

4 = Four Pass

5 = Five Pass

6 = Six Pass

Digit 13— Tube Passes (Condenser)

1 = Single Pass

2 = Two Pass

3 = Three Pass

4 = Four Pass

5 = Five Pass

6 = Six Pass

Model Number and Coding

When contacting Trane for technical support, customer service, or parts information, be prepared to provide the model number and serial number of the chiller in question. This information is located on the chiller nameplate that is affixed to each unit.

Chiller Model and Serial Numbers

For future reference, record the model number, job number, and serial number for each chiller. See table below.

Refer to the Trane nameplate on each installed unit for the serial number and model number.

Table 1. Chiller reference data

Module	Job Number	Model Number	Serial Number
1			
2			
3			
4			
5			
6			
7			
8			
9			
10			



Model Number

Critical information for contacting Trane technical support. Reference to the actual chillers serial number may also be beneficial. Each unit has its own unique serial number.

Model Coding Key

Model numbers assigned to Trane systems provide a wealth of information about the features for a chillers as built configuration.

Figure 1. Chiller nameplate

CHILLER	FLOODED CHILLER INDOOR		JOB #	22-1045AC	
MODEL	TACW125AT4046		DESIGN CONDITIONS FLUID = WATER FLUID CHILLER IN/OUT: 60°/44°F FLUID CONDENSER = WATER IN/OUT: 85°/95.75°F		
SERIAL#	AC22041412				
RATED POWER SUPPLY					
VOLTS	460	HZ	60	PH	3
CONTROL. VOLTS	24VAC				
ALLOWABLE VOLTAGE DROP	±10%				
TOTAL AMPS	127	MCA	158	MOCp	300A
SHORT CIRCUIT RATING : 10 KA RMS SYM					
.COMPRESSORS MAKE	DANFOSS TURBOCOR				
MODEL	TTS400HGS2S010X0XXS413	QTY	1		
	LRA	140	FLA	127	
COMPR. SER#	2227950021				
CONDENSER MAKE	ONDA	QTY	1		
CONDENSER P/N	B 56.1016 6P/S				
CONDENSER S/N	W2205791-07	CRN	NA		
EVAPORATOR MAKE	ONDA	QTY	1		
EVAPORATOR P/N	FLB 61.1016 4P M1/S				
EVAPORATOR S/N	W2205794-04	CRN	NA		
REFRIGERANT	R513A				
REFRIGERANT CHARGE			175	LBS	
MAX. PRESSURE	HIGH SIDE		LOW SIDE		
REFRIGERANT	225	PSI	200	PSI	
FLUID	150	PSI	150	PSI	
APPROXIMATE SHIPPING WEIGHT			4,900	LBS	
		<small>MANUFACTURERS OF INDUSTRIAL PROCESS COOLING EQUIPMENTS</small> 2100 STEELES AVE. E., BRAMPTON, ONTARIO L6T 1A7 TEL: (905)789-9988 www.trane.com			
					



Chiller Description

Chiller Scope

This manual provides relevant data to properly operate, maintain, and troubleshoot the Trane Packaged TACW chiller. Operator and maintenance personnel must be a qualified refrigeration technician and have a working knowledge of high voltage systems, low voltage control circuits, and components and functions.

Chiller Capacities

The Packaged TACW chillers utilize flooded shell and tube evaporators and condensers. They are available from 110 to 600 tons.

These chillers consist of an evaporator, condenser, twin-turbine centrifugal compressor(s), compressor controller, and interconnecting refrigerant piping. The chiller requires connection to the condenser and chilled water circuits, as well as the main electrical supply and control wiring.

The thermal capacity of these units is dependent on the leaving temperature of the chilled fluid, maintaining a minimum flow of fluid through the evaporator and keeping debris out of the system. In applications where it is desired to operate with a lower flow rate or higher temperature, consult the factory for recommendations.

Water quality must be monitored and maintained by a water treatment professional familiar with the materials of construction and operation of the equipment. The equipment arrives fully charged with refrigerant. As required under Federal regulations, installation, initial start-up, and technical servicing should only be performed by fully qualified personnel.

System Description

All Packaged TACW chillers are designed with a very small approach to enhance the compressor performance resulting in an outstanding IPLV rating. Chillers are available in different configurations and with various standard options including different compressor models to customize these chillers to your specific applications.

Standard Features

- ETL and AHRI Certified
- 10 kA SCCR Rating
- One to four Danfoss Turbocor Variable Speed, Magnetic Bearing, Oil-Free Centrifugal Compressor(s)
- Unprecedented Part-Load Performance, High Energy Efficiency, and Quiet Operation
- 5 percent Line Reactor per Compressor
- Mounted Fused Isolation Switch per Compressor
- Standard Single Point Power Connection
- Dual Manifold Pressure Relief Valve

- Danfoss Turbocor MCX Controller Complete with 10 inch Schneider HMI (Colored Monitor)
- Including a Web Server Allowing Remote Internet Monitoring, Remote Control, and Access to Operational Logs and Software Updates
- BACnet/LonWorks/ModBus Included Standard
- Shell and Tube and Evaporator and Condenser
- ASME/CRN Certified Cleanable Flooded Shell and Tube Condenser, with Standard 150 psi Design Pressure
- Standard Flow Switch Located at Evaporator and Condenser Hydronic Inlets
- An Electronic Expansion Valve per Circuit Providing Precise PLC Controlled Refrigerant Flow
- 3/4 inch (19 mm) Closed-Cell Insulation
- First year parts, refrigerant, and Labor Warranty

Chillers are leak and pressures tested at 200 psig at high side, 150 psig at low side, then evacuated and charged.

Self-contained chillers are equipped with a single source power source and integral hydronic piping.

Unit panels, structural elements and control enclosure are constructed of heavy-gauge powder coated aluminum and mounted on sand blasted welded structural steel base and painted with two parts epoxy paint for weather protection.

Optional Features

- Waterbox Condenser/Evaporator
- 300 PSI Waterbox Condenser/Evaporator
- 300 PSI Marine Waterbox Condenser/Evaporator
- Waterbox Hinges Condenser/Evaporator
- Epoxy Coated Condenser/Evaporator
- Flanged Connection Condenser/Evaporator
- Fused/Non-Fused Disconnect Switch
- Low Lift Refrigeration Pump
- Passive Harmonic Filters
- Rapid Restart
- Full/Partial Knockdown
- Remote Monitoring Wireless Module
- Compressor Wraps
- Isolation Pads
- 1.5-inch Insulation

Component Specification

Compact Turbocor Compressor

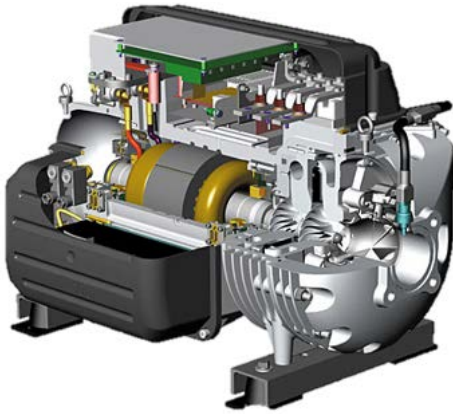

- Exclusive design of compressor with floating magnetic bearings
- Variable speed compressor with integrated VFD
- High efficiency with oil-less operation
- Centrifugal design giving low kW/ton
- Excellent capacity control with variable speed and variable guide vanes
- Superior IPLV values resulting in high energy savings
- Sophisticated digital control/instrumentation of Danfoss Technology
- Smaller footprint
- Low noise level (less than 70 dBA)
- Lightweight

Flooded Shell and Tube Evaporator and Condenser

- Extremely compact design
- 225 PSI operating pressure
- Maximum material efficiency due to no dead zone

- Small hold up volume uses only fraction of heat transfer (refrigerant) medium
- Copper enhanced tubing and steel tube sheet construction
- Operates efficiently at even 1 K temperature difference
- True counter-current flow allows close temperature approach
- Liquid level sight glass
- Liquid level float switch
- Grooved fluid connection for quick disassembly for service

Refrigeration Components

- Complete internal refrigeration piping
- Suction and discharge service valves
- Discharge check valve
- Variable speed two stage Turbocor oil-free centrifugal compressor with internal guide vane
- Flooded evaporator and condenser
- Liquid line filter
- Motor cooling kits
- Relief valves

Electrical

- NEMA 4 rated wired and tested electrical enclosure
- Power block to facilitate single source power
- Circuit breakers for compressors
- Control transformer with primary and secondary fusing
- Touch screen for display and control
- Flow switch
- Interlock auxiliary contacts
- PLC control system



General Data

Table 2. General data — Packaged TACW chiller

Model	TACW150AT	TACW150BT	TACW220BT	TACW525DT	TACW600CT
Tonnage Range	130 to 150	130 to 160	165 to 250	400 to 525	450 to 600
General Unit					
Number of Independent Refrigeration Circuits	SINGLE	SINGLE	SINGLE	SINGLE	SINGLE
R-513A Refrigerant Charge (lbs/Chiller) NO ECO	360	500	600	1100	1300
R-513A Refrigerant Charge (lbs/Chiller) With ECO	380	520	630	1300	1500
Chilled Fluid Volume (gal/Chiller)	26.2	38.8	55.3	106.9	123.4
Condenser Fluid Volume (gal/Chiller)	28.4	40.2	56.2	145.8	161.1
Compressor					
Type	CENTRIFUGAL	CENTRIFUGAL	CENTRIFUGAL	CENTRIFUGAL	CENTRIFUGAL
Quantity	1	2	2	4	3
Evaporator					
Type	SHELL AND TUBE	SHELL AND TUBE	SHELL AND TUBE	SHELL AND TUBE	SHELL AND TUBE
Quantity	1	1	1	1	1
Material (tubes/shell)	COPPER/STEEL	COPPER/STEEL	COPPER/STEEL	COPPER/STEEL	COPPER/STEEL
Condenser					
Type	SHELL AND TUBE	SHELL AND TUBE	SHELL AND TUBE	SHELL AND TUBE	SHELL AND TUBE
Quantity	1	1	1	1	1
Material (tubes/shell)	COPPER/STEEL	COPPER/STEEL	COPPER/STEEL	COPPER/STEEL	COPPER/STEEL
Dimensions / Weights					
Width (in) ^(a)	54	54	63	67	70
Depth (in)	90	142	150	172	172
Height (in)	94	87	95	110	113
Weight (lbs) ^(a)	5200	6500	8200	12700	14600

^(a) If an optional economizer is added, add 20% to the weight, and 6-inch to 12-inch to the width.



Installation Mechanical

Inspect and Report Damage

Upon receipt, inventory the shipment against the Trane bill of lading to ensure all units and components have been delivered.

Inspect each package in the shipment for visible damage. Verify the correct model number and that all skids and cartons have been delivered. Any damage must be reported to the motor carrier and Trane within five days of receipt of the shipment.

Inspect all exterior components for concealed damage as soon as possible. Do not proceed with the installation of damaged equipment without prior approval of Trane.

Do not refuse delivery of damaged goods without prior authorization. Unauthorized refusal of the shipment will result in a restocking charge to the customer.

The ownership of the equipment is transferred to the consignee at point of shipment. Refusal of delivery may impede recovery of damages.

It is the consignees responsibility to accept delivery of damaged goods unless permission to refuse delivery has been granted by Trane.

Inspection of Delivered Equipment

To report damage incurred in transit, complete the following:

1. Inspect each piece of equipment for visible damage before accepting delivery. Check for torn cartons, broken skids, bent metal and torn shrink wrap.
2. Ensure the delivery driver notes any damage on the bill of lading and completes a Carrier Inspection Report. Failure to comply may result in difficulties in resolving any claims for damage.
3. Inspect each piece of equipment for concealed damage before storage or as soon as possible after delivery.
4. In the event of suspected concealed damage, ask the driver to wait until you inspect the equipment. Concealed damage must be reported within five days of receipt of equipment.
5. If concealed damage is found, stop unpacking the shipment. Do not remove damaged material from the receiving location, take photos of the damage. The owner must provide reasonable evidence that the damage did not occur after delivery.
6. Notify the carrier of the damage as soon as possible. Request an immediate joint inspection by the carrier and consignee. A determination of responsibility will be made, and the carrier will authorize repairs in the event of admission of fault.
7. Notify your local Trane CSO immediately. Trane will coordinate repairs with the owner and carrier. Trane will coordinate repairs with the owner and carrier. Do not attempt to make repairs locally without permission.

Warranty Issues

Trane is not responsible for damages or for filing damage claims. It is the customers responsibility to ensure that the necessary long term storage procedures have been completed and any deviations are reported to Trane immediately.

Long Term Storage Requirements

Appropriate preparation and storage of Trane chiller components during extended periods of dormancy is essential to ensure the equipment does not sustain damage or degradation due to inactivity and operates properly after installation.

The customer must notify Trane during the sales process that the chiller system may be transported by ocean freight or placed in long-term storage under any of these conditions:

- The chiller will not be placed into operation for a period exceeding six months after leaving the Trane factory. That is, the initial start-up date will not occur within a six-month maximum dormancy window.
- The chiller will be shipped using ocean transit for all or part of the delivery process.

Factory Preparation

Upon confirmation of an order requiring long-term storage or protection against extreme environments, Trane will inspect and protect vendor-supplied components before installation.

Prior to shipment, Trane will prepare each chiller system for long-term storage in coastal or tropical environments by:

- Placing silica gel packs in all electrical panels and variable speed drive panels to prevent corrosion of electrical contacts and moisture from degrading sensitive controllers.
- Shrink-wrapping each chiller using polyethylene film to limit environmental exposure and protect the chillers from damage during shipping.

Trane will document and photograph the status of the unit prior to shipment and carry out the instructions detailed in the factory order regarding in-shop preparation of units for long-term storage.

Customer Responsibilities

Customer must inspect the unit upon receipt. Any visible damage to shrink wrap would warrant the removal of the shrink wrap for further inspection. Shrink wrap must be reinstalled after inspection.

Visible damage must be noted on the signed and dated bill of lading. The customer may request a carrier inspection by telephone or in person, but any such request should be



Installation Mechanical

confirmed in writing. It is recommended that the customer request that the carrier inspect the damage within 72 hours of notification.

If shrink wrap is damaged while in storage, shrink wrap must be replaced/repared before further transportation.

Failure to adhere to long-term storage requirements may void the Trane warranty. Any component that is damaged or inoperable due to improper storage may have its warranty voided.

Handling of the Chillers

The packaging from the factory permits lifting with a suitable crane. Ensure straps are in good working condition and that they are rated for the weight of the machines. Spreader bars may be required for effective rigging and to avoid damage to the chiller.

The chiller arrives fully charged with refrigerant. As required under Federal regulations, installation, start-up and service should be performed by fully qualified, factory-certified, personnel.

⚠ WARNING

Proper Field Wiring and Grounding Required!

Failure to follow code could result in death or serious injury.

All field wiring MUST be performed by qualified personnel. Improperly installed and grounded field wiring poses FIRE and ELECTROCUTION hazards. To avoid these hazards, you MUST follow requirements for field wiring installation and grounding as described in NEC and your local/state/national electrical codes.

⚠ WARNING

Electrical Shock, Explosion, or Arc Flash Hazard!

Failure to follow these instructions could result in death or serious injury.

- **Install the product in an appropriate electrical/ fire enclosure per local regulations. Do not install the product in hazardous or classified locations.**
- **Do not use the product for life or safety applications.**
- **Do not exceed the product ratings or maximum limits. Products rated only for basic insulation must be installed on insulated conductors.**
- **Current transformer secondaries (current mode) must be shorted or connected to a burden at all times.**
- **Remove all wire scraps, tools, replace all doors, covers and protective devices before powering the equipment.**

Site Preparation and Clearances

Chillers must be installed on a level surface that has been checked by a qualified structural engineer to support the weight of the fluid-filled units and the connective piping to and from the chiller. Installations must account for minimum service access clearances as may be practical or required by local building codes.

Chiller Clearances

The National Electric Code or local, state, and regional building codes may require greater clearance for the chiller than the figures listed in this publication. Always consult local regulatory agencies to ensure additional clearances are not required by building codes.

Minimum Clearances

The unit must maintain a minimum of 36 inches clearance on sides A and D, 24 inches on side C, and a clearance of 24 inches plus barrel length on Side B, with a 36 inches overhead height. See [Figure 2, p. 13](#).

Service Access

Compressors, filter-driers, and manual liquid line shutoff valves are accessible on each side or end of the unit.

Figure 2. Recommended chiller clearances

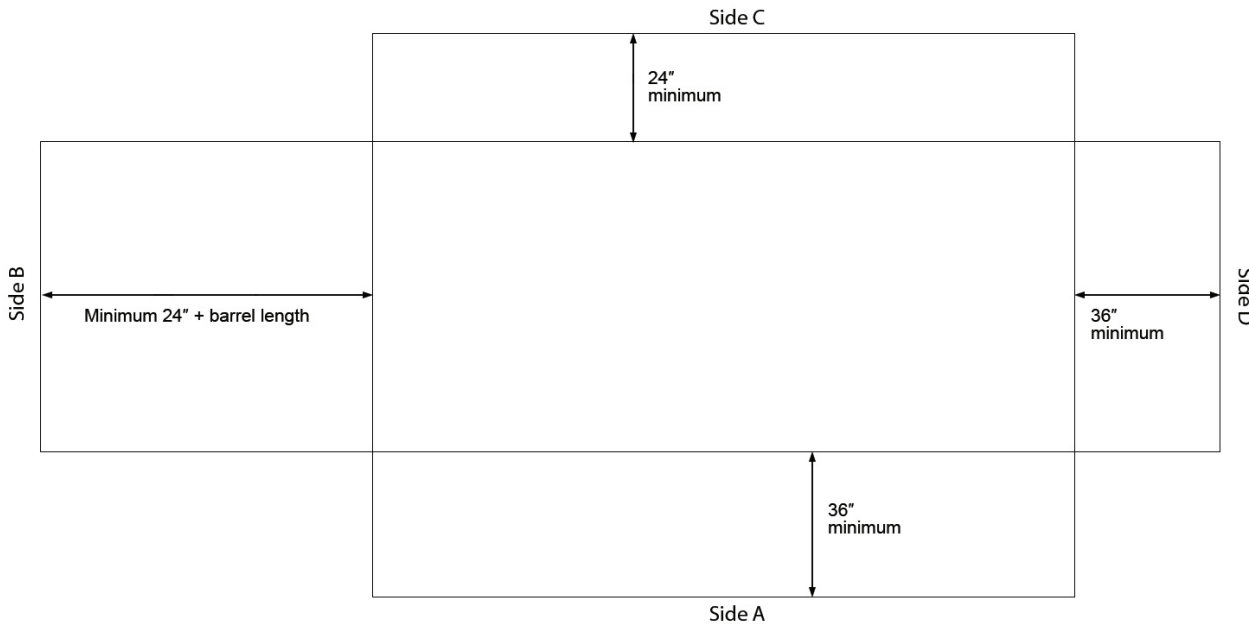

NOTE: 36 inches minimum overhead clearance

Rigging, Lifting, and Moving the Chiller

The Packaged TACW chiller can be delivered to the customers site as individual units. Limitations on the methods and materials that can be used to rig, lift, or move a chiller include:

- Maintain the chiller in an upright position at all times.
- Certain configurations of chillers can be top-heavy. Move chillers slowly with consideration for each units center-of-gravity.
- Rig, lift, and move by strapping and lifting using a properly configured floor jack or fork lift or by overhead means.
- Position lifting beams or spreader beams to prevent lifting straps from rubbing or contacting the chillers side panels or electrical boxes.
- Do not use cables, chains, or any other type of metalized strapping to lift a unit.
- Do not push a chiller while directly in contact with the floor using manual or mechanical means.

Figure 3. Recommended chiller rigging assembled unit

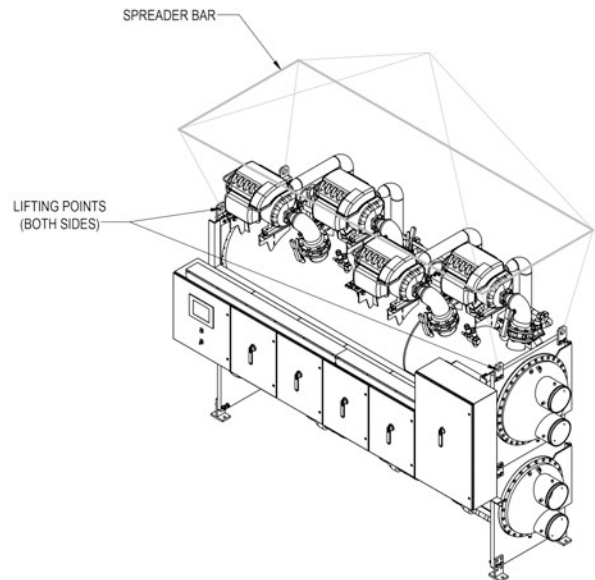

Chiller Placement

The chiller must be positioned on a firm level surface using waffle rubber isolation pads.

Installation Piping

Install Piping and External Components

Proper support of piping and pipe hangers must consider the weight of the piping as well as the water weight inside the pipes.

Figure 4. Recommended chiller piping

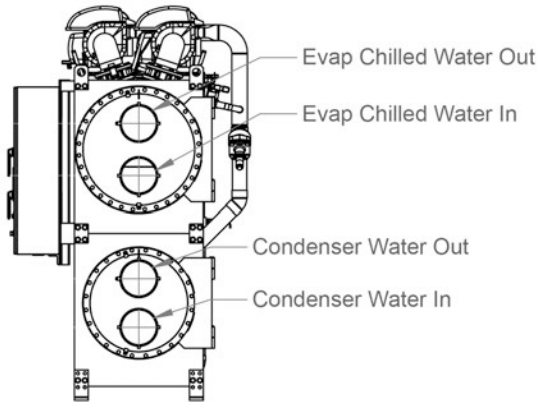

Initial Flushing of Piping

After installation of system piping and before connection to the chiller system, it is important to clean and remove

debris, weld slag, and other contamination deposited during fabrication of the piping system.

Typical flushing includes hot water with mild detergent followed by a dilute phosphoric acid solution until all visible residue is removed.

Cleaning liquids, acids, and detergents compatible with copper and carbon steel must be used. Consult a professional fluid treatment specialist when in doubt.

After detergent and chemical cleaning, flush the water piping with fresh water for one hour to remove any remaining cleaning compounds.

Fill with Water/Glycol Solution

In most instances, the installing contractor is responsible for charging glycol into the unit. If not charged, add glycol according to these instructions:

1. Mix the concentrate of propylene glycol in a tank or drum for transfer into the chiller.
2. Mix the glycol and water externally before filling the unit to prevent clogging of the chiller piping with a heavy concentrate.

Only after the above steps have been completed should the fluid piping be connected to the chiller system.



Installation Electrical

Connecting Module Power and Control Wires

Connections are typically made at the power distribution panel of each chiller.

⚠ WARNING

Proper Field Wiring and Grounding Required!

Failure to follow code could result in death or serious injury.

All field wiring **MUST** be performed by qualified personnel. Improperly installed and grounded field wiring poses **FIRE** and **ELECTROCUTION** hazards. To avoid these hazards, you **MUST** follow requirements for field wiring installation and grounding as described in NEC and your local/state/national electrical codes.

Power Distribution Panel

The chiller must be fed by its own individual power. All power wiring, up to the power panel, is the responsibility of the installing contractor.

BMS Wiring

The physical medium will be determined by project parameters and is the responsibility of the installing contractor.

Hardwire Options

Table 3. Hardwire options

Function	Detail
Analog Inputs	
Remote Setpoint	4 -20 mA Signal to control chilled water output. Requires remote setpoint enable.

Table 3. Hardwire options (continued)

Function	Detail
Remote Offset	4-20 mA signal to work with as chiller-based baseline setpoint. Requires remote offset enable.
External Load Shedding	0-10 v or 4-20 mA signal to limit max power of the chiller.
Chiller Pump Speed Ref	0-10 v or 4-20 mA signal use as a pass-through to control pump.
Digital Inputs	
Cooling Enable	Hardwired Binary input to enable and disable chiller. Requires chiller be in auto mode.
Remote Setpoint Enable	Binary input required to use remote setpoint.
Remote Offset Enable	Binary input required to use remote offset.
External Load Shedding	Binary input to engage external load limit internal chiller parameter.
Digital Outputs	
Chiller Pump Enable	Binary output to enable external chiller pumping package.
General Alarm	Binary output indicating occurrence of unacknowledged fault.
Chiller Running	Binary output indicating that any compressor is running.
Compressor Running	Binary outputs (up to 4) indicating specific compressor running.
No Compressor Available Fault	Binary output indicating that all compressors are not available to operate.
Chiller at Maximum	Binary output indicating chiller is producing its maximum cooling at the current conditions.
Cooling Tower Enable	Binary output to enable external cooling tower (water-cooled only).
Condenser Pump Enable	Binary output to enable external condenser pumping package (water-cooled only)



Pre-Start up

Preparation for Initial Start-Up

After the system is completely installed with all wires connected and all piping securely coupled, the chiller can be prepared for initial start-up.

Ensure that the proper request for start-up form has been completed and provided to your local representative.

Table 4. Start-up readiness checklist

Hydronic Checklist	
<input type="checkbox"/>	Piping complete and leak tested
<input type="checkbox"/>	Pre cleaning strainers are removed from chilled water side of system
<input type="checkbox"/>	Pre cleaning strainers are removed from condenser water side of system
<input type="checkbox"/>	Strainer installed before entering the evaporator (barrel for chilled water)
<input type="checkbox"/>	Strainer installed before entering the condenser (barrel for cooling tower water)
<input type="checkbox"/>	Water quality analyzed for water treatment
<input type="checkbox"/>	If applicable glycol concentration checked
<input type="checkbox"/>	Water systems filled and vented of all air
<input type="checkbox"/>	Pumps installed and rotations checked
<input type="checkbox"/>	Water control valves (external to chiller) installed and operating
<input type="checkbox"/>	Water system operating to meet design conditions
<input type="checkbox"/>	Pressure gauges installed on inlets and outlets of chilled water and condenser water barrels
Electrical Checklist	
<input type="checkbox"/>	Power wiring complete and in accordance with nameplate rating on unit and prepared for connection in accordance with installation manual
<input type="checkbox"/>	Proper wire sizing installed
<input type="checkbox"/>	Please record the wire sizing installed
<input type="checkbox"/>	Tower fan controller installed and operating to control tower fan
<input type="checkbox"/>	VFD's for all pumps wired and operational
Mechanical Checklist	
<input type="checkbox"/>	Verify that you have more than 70 % load on the building in order to test the chiller(s)
<input type="checkbox"/>	All air handlers are in full operation
<input type="checkbox"/>	BMS connected to chiller and ready for verification and testing



Operating Principles

This section contains an overview of the operating principles of the Trane Packaged TACW chillers equipped with Danfoss MCX controllers.

Refrigeration Circuits

The refrigeration cycle makes use of a shell-and-tube evaporator design with refrigerant evaporating on the shell side and water flowing inside tubes having enhanced surfaces.

The compressors are two-stage oil-free variable speed centrifugal magnetic bearing type. The magnetic bearings allow the compressor to operate without the use of oil for lubrication, which reduces energy losses due to friction and increases the heat transfer efficiency of the chiller. A variable speed drive on the motor allows the compressor to operate much more efficiently at partial loads.

Condensing is accomplished in a shell-and-tube heat exchanger where refrigerant is condensed on the shell side and water flows internally in the tubes. Refrigerant is metered through the flow system using an electronic expansion valve that maximizes chiller efficiency at part load. Microprocessor-based unit controls provide for accurate chilled water control as well as monitoring, protection and adaptive limit functions. The adaptive nature of the controls intelligently prevents the chiller from operating outside of its limits, or compensates for unusual operating conditions, while keeping the chiller running rather than simply tripping due to a safety concern. When problems do occur, diagnostic messages assist the operator in troubleshooting.

Refrigeration Cycle

Evaporation of refrigerant occurs in the evaporator that maximizes the heat transfer performance of the heat exchanger while minimizing the amount of refrigerant charge required. A metered amount of refrigerant liquid enters a distribution system in the evaporator shell and is then distributed to the tubes in the evaporator tube bundle.

The refrigerant vaporizes as it cools the water flowing through the evaporator tubes. Refrigerant vapor leaves the evaporator as saturated vapor.

The refrigerant vapor generated in the evaporator flows to the suction end of the compressor where it enters the

motor compartment of the motor. The refrigerant flows across the motor, providing the necessary cooling, then enters the compression chamber. Refrigerant is compressed in the compressor to discharge pressure conditions.

Immediately following the compression process the oil-free refrigerant vapor enters the condenser. Baffles within the condenser shell distribute the compressed refrigerant vapor evenly across the condenser tube bundle. Cooling device water, circulating through the condenser tubes, absorbs heat from this refrigerant and condenses it.

As the refrigerant leaves the bottom of the condenser, it enters an integral subcooler where it is subcooled before traveling to the electronic expansion valve. The pressure drop created by the expansion process vaporizes a portion of the liquid refrigerant. The resulting mixture of liquid and gaseous refrigerant then enters the Evaporator Distribution system. The flash gas from the expansion process is internally routed to the compressor suction, and while the liquid refrigerant is distributed over the tube bundle in the evaporator.

The Packaged TACW chiller maximizes the evaporator heat transfer performance while minimizing refrigerant charge requirements. This is accomplished by metering the liquid refrigerant flow to the evaporator's distribution system using the electronic expansion valve.

Compressor

The compressors use two impellers on a single, high-speed, rotating shaft. The rotating shaft and impeller assembly is the only moving part in the compressor.

The compressor has a fully integrated variable-speed drive with soft start. The variable-speed drive allows the compressor to be highly efficient, especially at partial load and the soft-start feature reduces start-up stress.

The single shaft rotates within magnetic bearings. This unique feature reduces friction, adding to the overall high efficiency, and eliminates the metal-on-metal contact of conventional bearings. This, in turn, allows the chiller to operate without the need for lubricating oil. Eliminating lubricating oil eliminates the need for several ancillary components required to support the oil system (e.g., oil pumps, oil heaters, oil separators, and oil filters).

Operating Procedures

Operator Interface

Trane Packaged TACW water-cooled units are complete chillers that work on their own.

Chiller Panels

There are three different electrical panels used in the TACW chiller:

- Power Distribution Panel
- Compressor Power Panel
- Control Panel

Figure 5. Typical power panel with four compressors

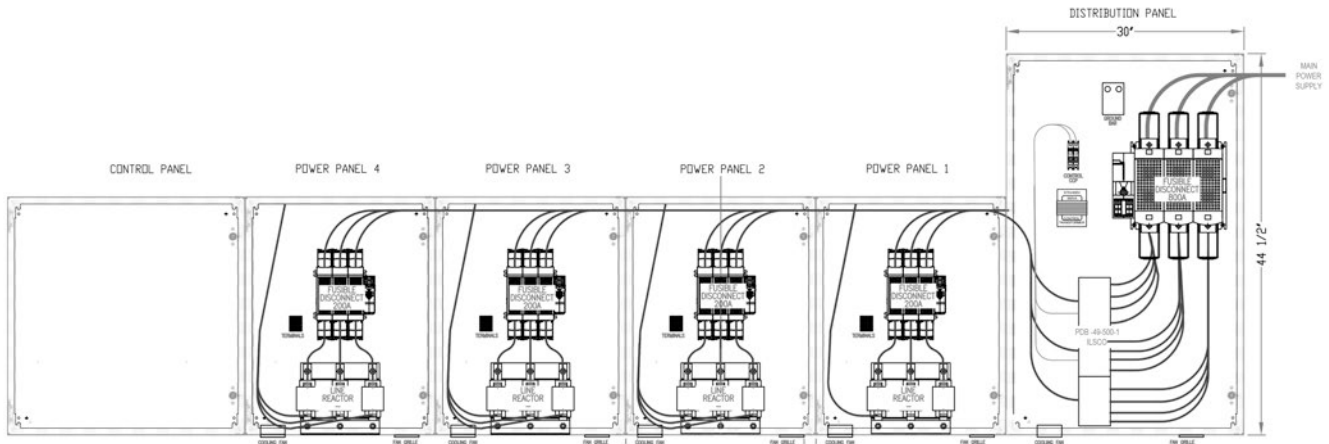

Power Distribution Panel

The power distribution panel receives power from the building source and distributes it to the chiller. It also houses an optional phase monitor and an optional main power fused disconnect.

Compressor Power Panel

Each compressor on the chiller requires its own power panel with fused disconnect, line reactor, and panel pan.

Control Panel

The control panel receives power from the power panel and provides power to the control components in the chiller. The Control Panel includes, but is not limited to, primary and companion controllers, HMI, BMS interface, Ethernet components for internal network, low-power fusing, and a terminal strip for customer control wiring.

Figure 6. Control panel

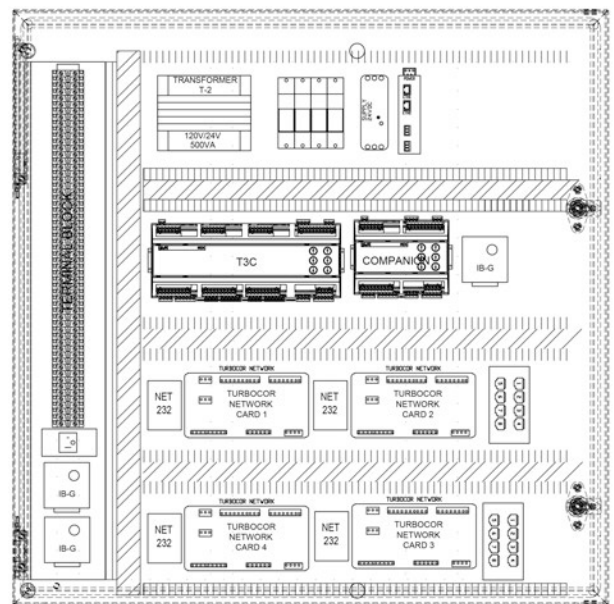

Panel-Mounted Disconnect Handle

Chiller systems are equipped with a panel-mounted disconnect handle installed on the outside of the power distribution panel. The disconnect handle must be turned to the OFF position before the panel can be opened for service. When the panel door is open, the power is disengaged.

Controller and HMI

The Trane Packaged TACW chiller models use Danfoss MCX microprocessor controllers and Schneider 10 touchscreen HMI to monitor and report critical operating parameters.

Figure 7. Danfoss MCX primary controller



Figure 8. Schneider 10-inch HMI touchscreen



Operating the Microprocessor

The touchscreen interface panel is ready to use when it is connected to the Ethernet switch and chiller powered is ON.

Microprocessor Functions

For practical purposes, all essential control information and operator actions are read and responded to using the

touchscreen interface panel. The touchscreen interface panel is connected to the primary and companion controllers.

NOTICE

Component Damage!
 Failure to follow instructions could damage sensitive electronic components beyond repair.
 To prevent arcing or surges of electrical current, do not use wires or cables to jump components or bypass the manufacturer's safety systems.

Operator Control

A touchscreen interface panel is the primary means for the operator or maintainer to monitor and modify a host of functions involving temperatures, pressures, set points alarms, elapsed operating hours, etc.

The touchscreen interface is connected to and communicates with all controllers via the Ethernet switch. It accesses overall chiller functions and settings.

Touchscreen Interface Tutorial – Control System

This section consists of a tutorial that first-time personnel can use to navigate through the various functions and features that are available in the interface.

The following is a typical About screen that provides you exact HMI software version and HMI Runtime version or firmware version.

Figure 9. Revision screen



This HMI software is designed to meet the needs of all chillers with 1 to 4 compressors and in either air-cooled or water-cooled configurations. In addition, this software provides visibility into external special controls and optional functionalities.

- Condenser Valve control
- Enhanced EXV control
- Cooling Tower Fan Enable/Control
- Economizers control
- Hot Gas Valve control
- Pump/Plant control

Operating Procedures

- BMS integration
- Primary/Secondary control of chiller array
- Low-Lift Application

Control Architecture

The control architecture is broken down in the following categories:

- Basic Controls – considers both standard water-cooled and air-cooled chillers
 - Standards
 - Menus
 - Data Displays
- Special Functions
 - Hand/Off/Auto
 - Chiller Setpoint Control
 - Enhanced EXV Control
 - Condenser/Fan/Cooling Tower Control/Bypass Valve
 - Tonnage and Power Calculations
 - Metric/Imperial Display
 - BMS Interconnectivity



- Compressor Staging Valve Control
- Optional Functionalities
 - Free Cooling
 - Pump and Plant Controls
 - Data Logging
 - Master/Slave
 - Controller option
 - Economizer
 - Hot Gas Bypass Valve
 - Low-Lift Application
- Security Configuration
- Alarm Handling

Basic Controls

This section describes the basic functions of the chiller control system.

- Standards and common features
- Menus
- Data Displays

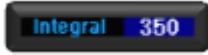
Display Common Features

Display Feature	Description	User Interface
Static Text	Static text is light or dark Cyan	
Dynamic Text	Dynamic text is context sensitive under the following guidelines. <ul style="list-style-type: none"> • Evaporator – No Flow • Condenser – Flow • Green indicates OK, Active, Enable or Normal. • Red indicates Off, inactive, Disable or Fault. • Yellow indicates warning or potential problem. 	
Dynamic Numeric Data	Dynamic numeric data is White	
User Numeric Data	User Numeric data (settings and Setpoints) White in a Blue box:	
Device HOA Control	Device HOA Control has 2 versions: <ul style="list-style-type: none"> • Off, Hand and Auto is generally used on pop-up setup windows. • Auto is used on device control pages. It is a multi-option click control which indicates each user click rotates to the next option – Auto-Off-Manual then back to Auto. 	

Display Feature	Description	User Interface
User Button	User buttons are generally blue with white text with some exceptions.	
User Option Controls	User option controls are multi-colored text values in a blue box. <ul style="list-style-type: none"> • Colors indicate a different selection. • Used for Device Algorithmic selection and Function Option selections 	

Menus

This system has three functional menus:

- Main Menu – persistent across all displays.
- Devices Menu – persistent across devices functions.
- Settings Menu – persistent across settings functions.

Main Menu

The main menu is part of the banner of all displays:

Figure 10. Main menu



The main menu is always available as long as the HMI is functional. It has the following features:

Table 5. HMI main menu features

Feature	Function
Logo/Title	Displays function descriptive title for the page.
Time/Date	For reference – settable through the BIOS of the HMI. See “Settings Menu,” p. 21.
	Press to return to the Main Page.
	For debugging purposes, the system provides a display of raw inputs and outputs.
	Displays compressor 1 detail. All the compressors’ pages can be accessed.
	Displays Alarm Page.
	Displays key process indicators – all fluid temperatures, suction and discharge pressures in large format and other parameters. Also, it displays ambient temperature, condenser fan speed for air-cooled chillers.
	Displays fluid temperatures against system demand in a 1-hour trend for water-cooled chillers. Displays evaporator fluid temperatures, ambient temperature, and condenser fan speed for air-cooled chillers.

Table 5. HMI main menu features (continued)

Feature	Function
	Accesses “Devices Menu,” p. 22. Subject to security level. You must be Tech level or above to invoke.
	Accesses “Settings Menu,” p. 21. Subject to security level. You must be Tech level to invoke.
	Triggers data logging snapshot.
	Displays About Page.
	Accesses Log-on screen of security.

Settings Menu

The settings menu, unlike the main menu, is not always available. It appears when the Setup button from the main menu is pressed. It will stay available while you are in the settings section of the HMI. This menu is only available and Setup button is only visible to users with Tech level security or above. The following is the settings menu:

Figure 11. Settings menu

The following table show the features accessed by the settings menu:

Table 6. HMI settings menu features







Feature	Function
	Displays chiller control page which includes setpoint parameters, staging info, and the chiller PID loop controls.
	Displays the compressor parameters page. Includes individual enable/disable compressor controls.
	Displays the controller-based Faults and Warnings. Note: Compressors have their own, independent set of safeties that should be configured with higher priority than the controller safeties.
	Displays controls that provide the chiller identity. Important: Settings should only be changed by Trane-trained representatives. Accessed by Admin Level Security only.
	For debugging purposes, this page displays the complete data array that is sent to the BMS system.

Table 6. HMI settings menu features (continued)

Feature	Function
	Displays user access manager for managing user passwords. Note: If you change passwords and forget them you will no longer have access to the HMI functions.
	Displays the setpoint reset settings page.
	The Comms screen lets a technician turn off components that are not part of the chiller; i.e., the system allows for 6 compressors, if the chiller only has 2, the other 4 will be turned off.
	Provides access to the BIOS of the HMI device.

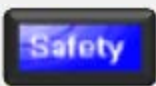
Devices Menu

The devices menu appears when the Device button from the main menu is pressed. It will stay available while you are in the devices section of the HMI. This menu is only available and visible to users with Tech level security and above.

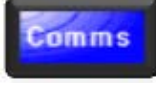
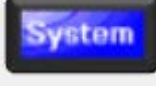
Figure 12. Devices menu

The following table shows the features accessed by the devices menu:

Table 7. HMI devices menu features

Feature	Function
	Displays a control overview of the EXV(s) in the system.
	Displays a control overview of the fan banks (optional) in the system.
	Displays a control overview of pumps (optional) in the system.
	Displays a control overview of the condenser valve (optional) in the system.
	Displays a control overview of the economizer valves (optional) in the system.

Table 7. HMI devices menu features (continued)

Feature	Function
	Displays a control overview of the hot gas bypass (load-balancing valve - optional).
	Displays (Optional) the master/slave (Primary/Secondary) configuration and status.

Data Displays

Main Menu

The following table shows the standard set of main menu HMI screens.

Table 8. HMI main menu screens

Screen	User Interface	Function	Access
Password Protection			<ul style="list-style-type: none"> Appears only after program has been loaded in HMI first time. If correct code has been entered, it will never appear again and HMI proceeds to Main screen upon power-up.
Main		<p>Primary Display</p> <ul style="list-style-type: none"> Displays All KPIs for the chiller. <ul style="list-style-type: none"> Compressor and Chiller State and compressors key refrigeration indicators. Evaporator and Condenser Specifics. Hand/Off/Auto (HOA) Control (see "Special Functions," p. 34). Demand, Capacity and Speed (see "Tonnage and Power Calculations," p. 41). Provides access to viewing and control of primary setpoint. 	<ul style="list-style-type: none"> Screen is first displayed on power-up and from the button on any other screen. Has security access: Clicking Circuit Data button displays pop-up of refrigerant circuit details. Click Return to dispose the pop-up.

Table 8. HMI main menu screens (continued)





Screen	User Interface	Function	Access
Digital I/O		<p>Displays current status of all hardwired digital inputs and outputs.</p> <ul style="list-style-type: none"> • Provides access to Analog I/O. • Provides access to Companion I/O. 	Main Menu > I/O
Analog I/O		<p>Displays current value of all hardwired analog inputs and outputs. Provides access to Digital I/O.</p>	Main Menu > I/O > Analog
Controller I/O		<p>Displays current value of all hardwired Companion PLC inputs and outputs.</p>	Main Menu > I/O > MCX061V
Compressor (1 for each compressor)		<p>Provides detailed snap-shot information regarding each compressor.</p>	Main Menu > Comp > Comp X
DTC Pressure/ Temperature Trend		<p>30 minute trend of compress suction and discharge temperature and pressure.</p>	Any compressor page > Trend

Table 8. HMI main menu screens (continued)

Screen	User Interface	Function	Access
Alarms		<p>Display, acknowledge and reset system alarms.</p> <p>Note: All alarms must be acknowledged and reset (green) before deletion.</p>	Main Menu > Alarm
<p>Display: display is different based on whether it is Air-Cooled or Water-Cooled Chiller. Both versions displayed here.</p>		<p>Displays water temperatures and system pressures in large font for easy long-distance reading. Air-cooled configuration replaces condenser water temperatures with ambient temperature and fan speed.</p>	Main Menu > Temp

Table 8. HMI main menu screens (continued)

Screen	User Interface	Function	Access
<p>Water Temp (trend): Context-Sensitive to Air- or Water-Cooled configuration.</p>		<ul style="list-style-type: none"> • Displays trend of the last hours data. <ul style="list-style-type: none"> – Evaporator water temperatures in and out. – Water-cooled: Condenser water in and out temperatures. – Air-cooled: Ambient temperature and fan speed (%). – Demand (%). • Has Y-axis runtime zoom. • Provides access to power trend. 	<p>Main Menu > Trend</p>
<p>Power Trend</p>		<ul style="list-style-type: none"> • Displays trend of the last hours data. <ul style="list-style-type: none"> – Calculated power (kW) – Measured 3-phase current (amps) – Air-cooled: Ambient temperature and fan speed (%). – Demand (%). • Has Y-axis runtime zoom. • Provides access to Temperature Trend. 	<p>Main Menu > Trend > Power</p>

Devices Menu

All device menu screens have a similar look and feel, reflecting control is also similar. They share the following properties:

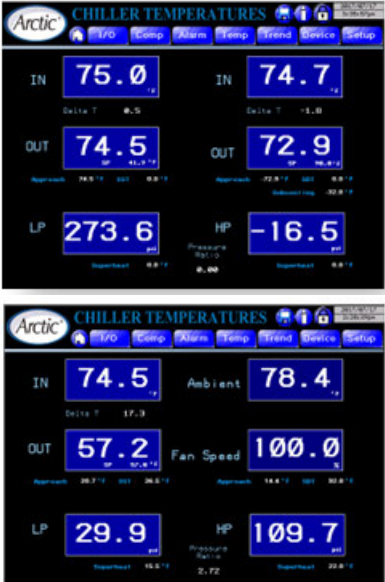
- Menus as standard across the whole system
- Display of current values for the KPIs (colour coded):
 - PV – Process value (cyan) is the signal the system is using for control.
 - SP – Setpoint (navy) is the value the system is trying to achieve.
 - CV – Control Value (red) is the output value to the controlling device.

- Trend Display from the previous 30 minutes also using the colour code above.
 - You can change range of the vertical axis with the Max/Min entries.
 - Calendar control allow access to historical data.
- HOA control, when in Manual control a data entry appears for the user to manipulate.
- Setup button – allows access to detailed control of the device.

The following table shows the standard set of devices menu screens.

Table 9. HMI devices menu screens





Screen	User Interface	Function	Access
EXV Control		<ul style="list-style-type: none"> • Display trend and settings of electronic expansion valves controls (see “Enhanced EXV Control,” p. 36). • Display expanded trend data. 	Main Menu > Devices Menu > EXV
Fan Bank Control		<ul style="list-style-type: none"> • Display trend and settings of banks of fans controls (see “Condenser Control,” p. 38). • Provides access to free cooling fan control screen. 	Main Menu > Devices Menu > Fan
Free Cooling Fan Bank Control		<ul style="list-style-type: none"> • Displays trend of free cooling controlled temperature against fan speed in free cooling mode and settings. • Provides access to free cooling valve control screen. 	Main Menu > Devices Menu > Fan > Free Cool
Free Cooling Valve Control		<ul style="list-style-type: none"> • Displays trend of free cooling controlled temperature against free cooling valve position and settings. • Provides access to free cooling fan control screen. 	Main Menu > Devices Menu > Fan > Free Cool > Valve

Table 9. HMI devices menu screens (continued)







Screen	User Interface	Function	Access
Evaporator Pumps Control		<ul style="list-style-type: none"> Displays trend and settings of evaporator circuit pumps controls (see "Condenser and Evaporator Duty/Backup Pumps," p. 54). Provides access to condenser pumps control screen. 	Main Menu > Devices Menu > Pump
Condenser Pumps Control		<ul style="list-style-type: none"> Displays trend and settings of condenser circuit pumps controls (see "Condenser and Evaporator Duty/Backup Pumps," p. 54). Provides access to evaporator pumps control screen. 	Main Menu > Devices Menu > Pump > Cond Pump
Condenser Valve Control		Displays trend and settings of condenser circuit bypass valve controls (see "Condenser Control," p. 38).	Main Menu > Devices Menu > Cond
Economizer Control		Display and configure economizers settings and parameters (see "Economizer Control," p. 56).	Main Menu > Devices Menu > ECO

Table 9. HMI devices menu screens (continued)

Screen	User Interface	Function	Access
<p>Hot Gas Valve Control</p>		<p>Displays trend and settings of Hot Gas Valve controls (see "Hot Gas Bypass Valves Control," p. 57).</p>	<p>Main Menu > Devices Menu > HGV</p>
<p>Master/Slave Configuration (Primary/Secondary)</p>		<p>Display and configure the Master/Slave configuration (see "Primary/Secondary Control (Chiller Array)," p. 55 – Master/Slave).</p>	<p>Main Menu > Devices Menu > M/S</p>



Operating Procedures

Setting Menu

The following tables shows the standard set of setting menu screens. All settings pages are Tech Level Access or

above with the exception of HMI configuration page which is Admin Level.

Table 10. HMI settings menu screens

Screen	User Interface	Function	Access
<p>Compressor Setup</p>		<ul style="list-style-type: none"> • Display and adjust compressor specific parameters. • See T3C Documentation for specifics on the settings with the exceptions. <ul style="list-style-type: none"> – Parameters Compressor Motor Power and Rated Power Consumption require that the controller be power cycled to fully accept any changes to these values. – IGV Stage Down Pos. – The chiller will stage down compressors independently of the LUZ calculations above if IGV open position drops below this value. – Parameters Max Start Pressure Ratio (MAX) and Stage-In Timeout work together insofar as, at the point of stage in, the chiller assesses if the system pressure ratio is below MAX. If it is, staging proceeds, otherwise, the chiller puts running compressors into Retreating and starts to reduce system demand in an effort to bring system pressure ratio below MAX. – Power @ Max and Speed @ Max are also evaluated as part of Stage-In Logic. 	<p>Main Menu > Settings Menu > DTC</p>

Table 10. HMI settings menu screens (continued)



Screen	User Interface	Function	Access
<p>Chiller Control</p>		<ul style="list-style-type: none"> • Admin Level Chiller SP Control (see “Special Functions,” p. 34). • Display and adjust chiller PI Loop settings. • Compressor staging control is a differential control known as Low Urgency Zone (LUZ) in this software. It has separate positive and negative dead band settings for both delta temperature and timing. Notes: <ul style="list-style-type: none"> – While chiller operates within LUZ limits, all control is via PI loop. – If Control Signal is greater than Chiller Setpoint + LUZ stage-in setting for longer than LUZ Stage-in time AND compressor power greater than Power @ Max setting (See Compressor Control Settings), then stage in next compressor. – If Control Signal drops below Chiller Setpoint – LUZ Stage-out for longer than LUZ stage-out time, then stage out a compressor. • Control Signal – The system provides the following options for chiller control. <ul style="list-style-type: none"> – EWT – The chiller controls to an entering (or Return) water temperature setpoint. – LWT (Default) – The chiller controls to a leaving water (Supply) temperature setpoint. – Hot – The chiller controls to a leaving condenser water temperature setpoint (Heat Recovery). – TSuc – The chiller controls to a suction temperature setpoint. • DTC Multi-Start Delta Temp – When the chiller is idle, enabled and looking to start, it compares the LWT with setpoint, the difference is divided by this parameter and the integer value of this calculation is added to the number of compressors to start; i.e., Differential is 6.5, parameter is 3 – integer division yields a value of 2; therefore, with a normal start of 1 compressor plus 2 from delta start yields 3 compressors start in this condition. • Evaporator/Condenser DP/flow settings (if applicable). • Tonnage Calculation Configuration (see “Special Functions,” p. 34). 	<p>Main Menu > Settings Menu > Control</p>
<p>Safety</p>		<p>Display and adjust safety parameters.</p> <p><i>Note: The compressors have their own safety settings for fault and alarm. System should be configured such that the compressor settings have priority.</i></p>	<p>Main Menu > Settings Menu > Safety</p>

Table 10. HMI settings menu screens (continued)







Screen	User Interface	Function	Access
HMI Configuration		Enable/Disable or select Special and Optional Functionalities . Details for each function are described in the sections Special Functions and Optional Functionalities.	Main Menu > Settings Menu > HMI Admin access only.
BMS Interface		Display output Building Management System. <i>Note: This page validates the communication between Chiller and the Trane Technologies BMS gateway (FieldServer).</i>	Main Menu > Settings Menu > BMS
User Manager		Provides an interface to the security system for the management of users and passwords.	Main Menu > Settings Menu > Users
Temperature Compensation		Display and configure setpoint compensation.	Main Menu > Settings Menu > Reset
Communication Control		<ul style="list-style-type: none"> Turn off communications to unused system components. Monitor communication statistics. 	Main Menu > Settings > Comms

Table 10. HMI settings menu screens (continued)

Screen	User Interface	Function	Access
Companion IO Configuration		<ul style="list-style-type: none"> Allows use of T3C Output terminals, both analog and digital for Companion functions. Touch each output configuration box to scroll through available functions. Since this page is accessed through the HMI configuration page which has admin access only, this page is also admin access only. 	Main Menu > Settings Menu > HMI > Companion > T3C IO
Admin Parameters (Admin Credentials)		<ul style="list-style-type: none"> Controller Software Revision Project information Master Switch control Power Metering reset Re-initialize compressor communication HMI reset 	Main Menu > Settings Menu > HMI > Admin Parameters Admin access only.

Special Functions

The following table lists the special functions of this control system:

Table 11. Chiller control system special functions list

Function	Brief	Access Level
Hand/Off/Auto	Allows user to manually enable the chiller to operate based on its own signals	User
Chiller Setpoint (User)	Allows user to view the chillers setpoint.	User
Chiller Setpoint (advanced)	Allows user to change the setpoint functions	Admin
EXV Control	Monitor and Control EXVs functions	Tech
Condenser Control	Monitor and Control fan banks and condenser bypass valve functions	Tech
Tonnage and Power (View)	See pop-up display of data	User
Tonnage and Power (Control)	Adjust settings	Admin
Metric/Imperial	Set system to display either metric or imperial units	Admin
BMS Monitor and Control	Provides interface between chiller and BAS	Admin
Compressors Staging Valve Control	Monitor and Control compressor staging valves	Tech

Hand/Off/Auto

The Hand/Off/Auto control consists of 2 components:

- Display and Access button (invokes control screen)



- Control screen



The Hand/Off/Auto function has 3 modes:

- Off** – no function. Compressors are off and remain so regardless of loop temperatures. All display functions work as normal. Chiller Enable is White and OFF.
- Hand** – the chiller controls the compressors based on (by default) achieving setpoint on leaving chilled water temperature. Chiller Enable displays Red and Hand.
- Auto** – this mode requires an external (hardwired) signal providing Chiller Enable; otherwise, Chiller is Off. Once Chiller Enable signal is provided, chiller controls compressors according to setpoint. Chiller Enable displays White and Auto.

Chiller Setpoint Control

Multiple chiller setpoint control modes are available. These are:

- User Setpoint
- Digital Offset
- Remote Setpoint
- Remote Offset

The chiller ultimately works with one value for setpoint, this value is always displayed on the Main screen in the Evaporator section, labeled SET POINT:

Figure 13. Main screen



User Setpoint

To Access the Chiller Setpoint control screen, select the setpoint indicator from the Main screen or the Chiller Control screen. See the following figure.

Figure 14. Chiller setpoint control

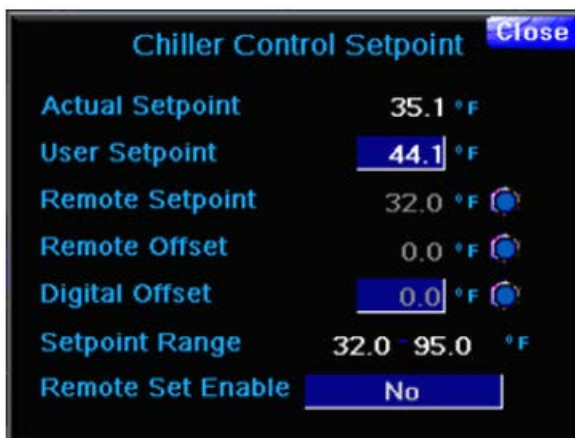

To change the setpoint:

1. Touch User Setpoint.
2. Enter a new value in the keyboard that appears.

In user setpoint mode, Actual Setpoint equals to User Setpoint.

Digital Offset

This feature requires a parameter and a digital input. The parameter, Digital Offset is exposed to the HMI on the Chiller Control Setpoint screen:

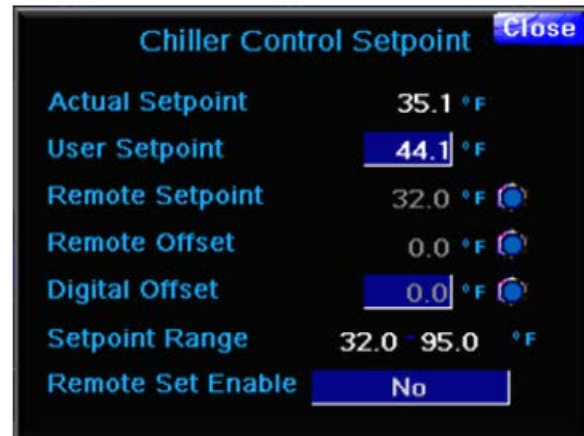

The chiller control setpoint screen allows you to enter a value (0 to 10) in °C or °F depending on the HMI configuration. Digital Input #4 enables the digital offset functionality. When this input is on, the digital offset display turns blue and the accompanying pilot lights up.

Remote Setpoint

When enabled it ignores the user setpoint and reads analog input #1. This function requires:

- Inputs:
 - Remote Setpoint – Analog Input #1 – range: 0-100° C or 32-212°F.
 - Remote Setpoint Enable – Digital Input #3.
- Parameter:
 - Remote Set Enable – set to Absolute.

Figure 15. Chiller setpoint control - Remote setpoint

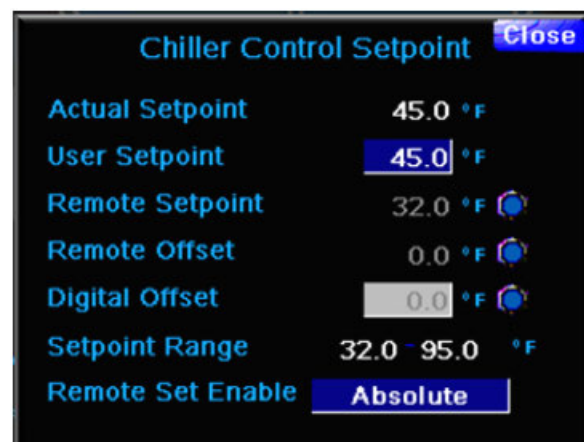

Note: Actual Setpoint equals Remote Setpoint.

With Digital Offset

Remote setpoint and the digital offset can be combined:

Figure 16. Chiller setpoint control - Remote setpoint with digital offset

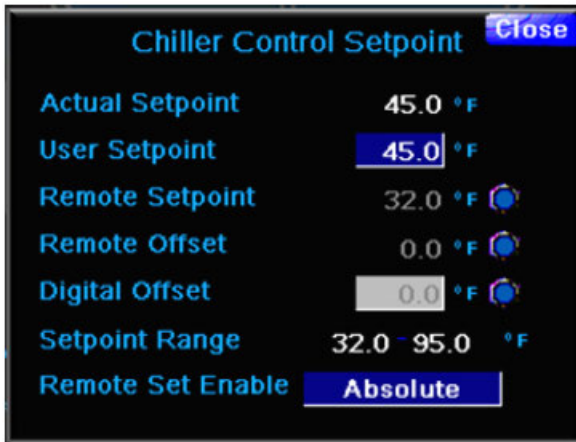

In this situation, the controller adds the offset value to the remote setpoint value.

Example: $49.3 + 1.4 = 50.7$

This requires everything in the previous section plus the Remote Offset Enable input (#4).

Remote Offset

Remote Offset and Digital Offset can be used concurrently:

Figure 17. Chiller setpoint control - Remote offset with digital offset

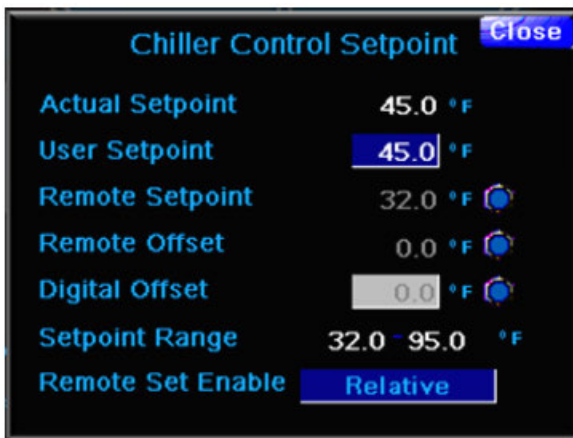

To use this scenario the controller requires:

- Inputs:
 - Remote Offset Enable – input #4.
- Parameters:
 - Remote Set Enable – set to Relative.

The actual setpoint is calculated as below.

User Setpoint + Digital Offset + Remote Offset
 $42.3 + 1.4 + 0.2 = 43.9$

Enhanced EXV Control

The chiller has two options for controlling the EXV(s):

- Disabled – Indicates that the EXV is controlled externally without any visibility at the HMI.



- ArcticCool – ArcticCool T3C Companion Controller (preferred control option).



The following table displays the varied EXV control screens with their options and limitations.

Table 12. EXV control options





Screen	Controls	Access
	<p>ArcticCool EXV Control.</p> <ul style="list-style-type: none"> This option requires ArcticCool T3C Companion Controller. The T3C Companion works with the ArcticCool Main Controller; they share information including Inputs and Outputs. The Companion cannot work as a stand-alone controller because it does not have the inputs and outputs to sustain the functionalities built in. It is designed as a companion relying on the Main Controller. Five control modes: <ul style="list-style-type: none"> Liquid Level High Pressure side – requires Level sensor on the condenser. Liquid Level Low Pressure side – requires level sensor on the Evaporator. Suction Superheat. Discharge Superheat. Sub-Cooling – Requires liquid line temperature sensor. Setpoint adjusts automatically based on chiller capacity. Capable of controlling up to four refrigeration circuits. 	<p>Main Menu > Devices Menu > EXV</p>
	<p>ArcticCool EXV Setup Page.</p> <ul style="list-style-type: none"> PID Loop constants: P-Gain and Integral Minimum Setpoint (for Sub-Cooling mode only). Master Setpoint display: <ul style="list-style-type: none"> Adjustable Setpoint for all the modes but Sub-Cooling. Maximum Setpoint (for Sub-Cooling mode only). 	<p>Main Menu>Devices Menu> EXV>Setup</p>
	<p>EXV Common Parameters. Circuit Common Parameters: Max and Min operational valve values.</p> <ul style="list-style-type: none"> Start Position and Time Sensor Failover Position Low Lift Functions 	<p>Main Menu>Devices Menu>EXV>Setup>Common Parameters</p>

Table 12. EXV control options (continued)

Screen	Controls	Access
	SubCool Reset Function.	Enable and disable from the HMI configuration screen.
	Evaporator Approach Reset. For sub cooling algorithm only Function: set PI parameters.	Pick point from EXV control screen, available when using sub-cooling algorithm.

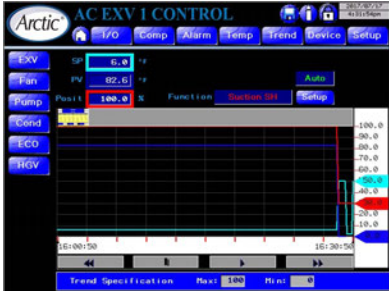
Condenser Control

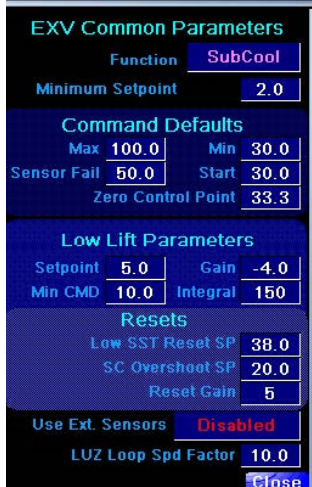
The control system can control external devices and any devices that are local to the chiller. Two of the features are:

- Condenser Valve Control
- Condenser Fan Control

Condenser Valve Control

The condenser valve can be a device attached to the chiller or just as simple as a device connected to the BMS. The controller provides a signal reference that is PID driven to control the condenser inlet temperature to a defined setpoint value. The chiller control system provides two options as selected from the HMI configuration page.

HMI Condenser Control:

- Disabled – This option indicates no controllable condenser valve exists.

Disabled
- ArcticCool Control – This option requires ArcticCool T3C Companion controller. The T3C Companion works with the ArcticCool Main controller; they share information including inputs and outputs. The companion cannot work as a stand-alone controller because it does not have the inputs and outputs to sustain the functionalities built in. It is designed as a companion relying on the main controller.

ArcticCool

Condenser Valve Control main page:

- Condenser Valve Control

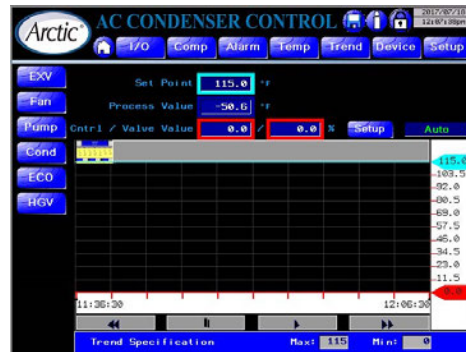

- Displays trend and current values for Setpoint, Process Value and Control value.
- Setpoint is Tech level adjustable if corresponding option selected on Setup screen. See below.
- Valve Control Mode: Auto/Manual/Off.
- To access other settings, click **Setup**.
- Trend has y-axis zoom capability.
- Access: **Main Menu > Devices Menu > Cond.**

- Condenser Valve Setup

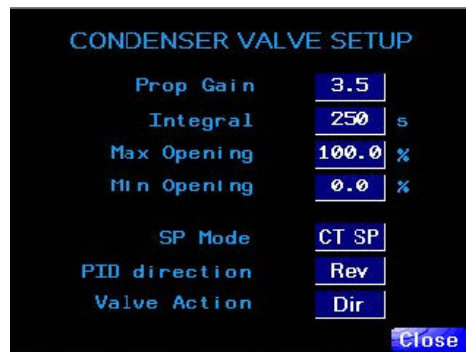

- P-Gain and I PID constants.
- Maximum and Minimum valve opening settings.
- SP Mode. CT SP – condenser valve shares the same SP as a cooling tower; SP – condenser valve

uses individual SP adjustable on the main condenser valve screen.

- PID direction. Rev – PID acts in Cooling mode; Fwd – PID acts in Heating mode.
- Valve Action. Dir – maximum PID signal corresponds to valve fully opened state; Rev – maximum PID signal corresponds to valve fully closed state.
- Access: **Main Menu > Devices Menu > Cond > Setup.**

Condenser Fan Control

The chiller control system has two options for condenser fan control as selected from the HMI configuration page – HMI fan control:

- Disabled – No condensing fan control from chiller control system. This option is common in water-cooled projects where condenser cooling is provided by others.



- ArcticCool Control – Requires T3C Companion Controller. Preferred control methodology. This option requires T3C Companion Controller. The T3C Companion works with the Main Controller; they share information including Inputs and Outputs. The Companion cannot work as a stand-alone controller because it does not have the inputs and outputs to sustain the functionalities built-in. It is designed as a companion relying on the main controller.



The Fan Control option of the T3C Companion Controller has the following features:

- Four independent circuits
- Optimizes chiller operation based on ambient temperature, running compressors speed or wet bulb temperature
- Optimizes chiller efficiency based on chiller load
- Staging control for first two fan banks
- Provides access to Free-Cooling Option (see “Optional Functionalities,” p. 53).

The control page for this option has all the standard features:

Figure 18. Fan control screen



Depending on SP mode selection Setup page settings layout will look slightly different.

Table 13. Fan control options





Screen	Controls	Access
 	<p>Common Controls:</p> <ul style="list-style-type: none"> • P-Gain is the proportional component of the control loop. • Integral for the control loop in seconds. • Min and Max Speeds allow user to tailor the controls to the application. • Start Speed ensures refrigerant movement during start-up phase of the circuit. • Failover Speed allows for fault tolerance of sensors in the system. • Maximum/Minimum SP – Restriction values for the SP. • Off Delay and Off Speed – When fan turns off it still runs for this delay at this speed. 	<p>Main Menu > Devices Menu > Fan> Setup>Common Parameters</p>
	<p>Ambient-based SP control:</p> <ul style="list-style-type: none"> • Uses chiller Capacity Compensation algorithm. • Resulting SP includes also the dynamic portion based on the following parameters: <ul style="list-style-type: none"> – Minimum Approach allows for fine tuning of dry bulb operation of the coils – Maximum Approach works with the aspects of the chiller to optimize efficiency across the range of operation 	

Table 13. Fan control options (continued)

Screen	Controls	Access
	<p>Compressor speed-based SP control:</p> <ul style="list-style-type: none"> Looks at running compressors average speed to decide on increasing or decreasing SP. Initial SP – When chiller starts this becomes the control SP. Low/High Speed SP – If compressors average speed remains below Low Speed SP, resulting SP will be decremented every SP Period seconds by Delta SP. And visa versa, if compressors average speed remains above High Speed SP, resulting SP will be incremented every SP Period seconds by Delta SP. 	
	<p>Wet bulb-based SP control:</p> <ul style="list-style-type: none"> Looks at wet bulb temperature reading. Resulting SP includes also WB SP Offset which adds up to wet bulb temperature. This type of control SP available for fan bank 1 only that is cooling tower control for Water-Cooled Chillers. 	

Tonnage and Power Calculations

When a user clicks the graphic display of demand, capacity, and speed, the tonnage and power data pop-up page is displayed.

Figure 19. Power and capacity control screen



Power Calculations

The power calculations start from the physical value, Power, from the compressors – a totalized instantaneous power from all compressors in the chiller. This value is integrated over an hour period to provide Hourly Usage.

The Hourly Usage value is totalized daily for the data logging report (resets at midnight) into Daily Usage variable.

Also at midnight it adds up to both monthly variable Monthly Usage and total variable Total Usage. Monthly Usage resets on the 1st day of the month at midnight.

Total Usage however does not reset ever unless button Reset kWh is pressed. This button is available at **Main Menu > Settings Menu > HMI > Admin Parameters** and can be accessed by Admin user only.

Beside the Total Usage variable there is the date which indicates when Total Usage kWh count started. When Total Usage kWh count starts over after being reset, the date updates as well.

Tonnage

To display tonnage and flow:

1. Navigate to HMI Configuration screen.
2. Change Flow Metering mode to one of the options shown below. This will display corresponding controls on Chiller Control screen.

Figure 20. Flow metering

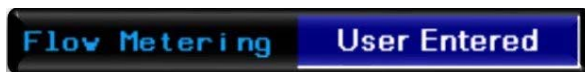

3. Flow Metering source options:
 - a. User Entered – Provides Chiller Flow Rate data entry on the Chiller Control screen. Enter a theoretical flow value for the chiller.

Figure 21. Chiller flow rate

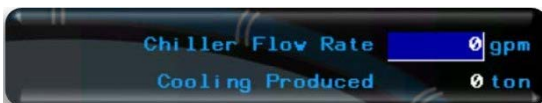

Note: The tonnage display will also reflect this theoretical value.

- b. Flow Meter – relies on Main PLC analog input to have a calibrated flow rate for the chiller.
Enter the Flow Meter Maximum value on the Chiller Control Screen.

Figure 22. Flow meter maximum



- c. Differential Pressure– relies on 2 pressure sensors; one inlet and one outlet connected to Main PLC.

Provides the following additional fields:



- Nominal flow – enter the design 100% load flow rate.
 - Nominal Differential pressure – enter the DP reading for 100% design flow rate.
 - Evaporator Flow Threshold – enter minimum value of DP that is considered a flow proof.
 - Actual DP displays the difference between Entering and Leaving fluid pressures.
 - Actual Flow displays the results of the internal calculation based on measured DP.
4. Enter Fluid Compensation Factor on the Chiller Control screen if the fluid used is not water.

Metric/Imperial Display

The System allows you to customize your display to suit your environment. Whether you prefer to see data in imperial or metric units, it is a single click of a button:

1. Navigate to the HMI Configuration screen – **Main Menu > Settings Menu > HMI**.
2. Toggle the **Display Imperial** button. Button displays current setting.

Figure 23. Display imperial button



BMS Interconnectivity

Chiller system includes a standard building system interface that has a comprehensive set of data points, status, alarms, and faults. This section outlines our standard list protocols, a definition of the special functions available, a note on default configuration, and a complete data list for our interface.

The device is a FieldServer Protonode from MSA Safety with Trane-specific configuration.

Protocols

The chiller control system supports the following BMS communication protocols.

- Modbus RTU
- Modbus IP
- BACnet MS/TP
- BACnet IP

- EthernetIP (Allen-Bradley®)
- N2 Metasys
- LONWorks with optional hardware

Special Functions

All chiller variables available for BMS system are read-only except for (all Objects type AV):

- **Alarm reset** – Value of 2 is required to reset alarms.
- **Adiabatic Cooling EN**– if the chiller is equipped then 0 – disable and 1 – enable.
- **Low Noise** – engages low noise system: 0 – disable and 1 – enable.
- **Low Setpoint** – Value for fan speed in low noise mode – in % of full Speed
- **External Load Limiting** – setpoint in kW.
- **Chiller Flow** – setpoint in units of selected control mode.
- **Chiller Setpoint** - Variable tag CHIL_EN_01 (see below).
- **Chiller Off/Hand/Auto control** - Variable tag CHIL_SP_02 (see below).

Note: Chiller Setpoint and Chiller Enable require special arbitration and are exposed to BMS as read-write variables when corresponding options are enabled on HMI Configuration screen only. Enable indicates that the chiller relies on the BMS interface for control; disable indicates that signal source is local or hardwired. See Special Functions: Hand/Off/Auto and Chiller Setpoint Control.

Figure 24. BMS configuration screen

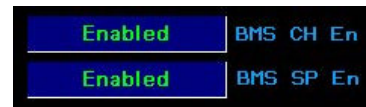

All other AV points are processed as a change of value.

Default Configuration

As part of factory start up, Trane sets the BMS interface in the following way:

- Default Password is **!admin321**.
- Default security is HTTP.
- Protocol is determined by project submittal.
- Ethernet port 1 is dedicated to internal chiller communication and is configured as Modbus TCP. IP address is factory set.

All other settings like instance IDs, protocol specifics (baud rates, parity, CRC, etc.), and specific security configurations are deferred to field start-up.

When BMS is connected in the preferred protocol, the entire data set is exposed. The listing is in the following two tables:

Table 14. BMS analog data listing

Tag Name	Description	Object Type	Object Id	Modbus Register	EIP Read Tag Name	EIP Write Tag Name
Chiller Enable	Chiller Enable Set from BMS and Feedback	AO	1	30001	AO_01[0]	WR_AO_01[0]
Chiller User Setpoint	Chiller Setpoint from BMS	AO	2	30002	AO_01_SC[1]	WR_AO_01_SC[1]
Chiller Inlet Fluid Temperature	Chiller Inlet Temperature (Integer Value with 1 implied decimals)	AO	3	30003	AO_01_SC[2]	WR_AO_01_SC[2]
Chiller Outlet Fluid Temperature	Chiller Outlet Temperature (Integer Value with 1 implied decimals)	AO	4	30004	AO_01_SC[3]	WR_AO_01_SC[3]
Condenser Inlet Fluid Temperature	Condenser Inlet Temperature (Integer Value with 1 implied decimals)	AO	5	30005	AO_01_SC[4]	WR_AO_01_SC[4]
Condenser Outlet Fluid Temperature	Condenser Outlet Temperature (Integer Value with 1 implied decimals)	AO	6	30006	AO_01_SC[5]	WR_AO_01_SC[5]
Condenser Setpoint	Condenser Setpoint (Integer Value with 1 implied decimal)	AO	7	30007	AO_01_SC[6]	WR_AO_01_SC[6]
Chiller Limit	Chiller Limit Percent (Integer Value with 1 implied decimal)	AO	8	30008	AO_01[7]	WR_AO_01[7]
Chiller State	Chiller State (see Details Page for State Enumeration)	AO	9	30009	AO_01[8]	WR_AO_01[8]
Chiller Power	Chiller Power (Integer Value with 1 implied decimal)	AO	10	30010	AO_01_SC[9]	WR_AO_01_SC[9]
Chiller 3-Phase Current	Chiller Current	AO	11	30011	AO_01[10]	WR_AO_01[10]
DTC1 Compressor Power	Compressor Power (Integer Value with 1 implied decimal) - Compressor #1	AO	12	30012	AO_01_SC[11]	WR_AO_01_SC[11]



Operating Procedures

Table 14. BMS analog data listing (continued)

Tag Name	Description	Object Type	Object Id	Modbus Register	EIP Read Tag Name	EIP Write Tag Name
DTC2 Compressor Power	Compressor Power (Integer Value with 1 implied decimal) - Compressor #2	AO	13	30013	AO_01_SC[12]	WR_AO_01_SC[12]
DTC3 Compressor Power	Compressor Power (Integer Value with 1 implied decimal) - Compressor #3	AO	14	30014	AO_01_SC[13]	WR_AO_01_SC[13]
DTC4 Compressor Power	Compressor Power (Integer Value with 1 implied decimal) - Compressor #4	AO	15	30015	AO_01_SC[14]	WR_AO_01_SC[14]
DTC5 Compressor Power	Compressor Power (Integer Value with 1 implied decimal) - Compressor #5	AO	16	30016	AO_01_SC[15]	WR_AO_01_SC[15]
DTC6 Compressor Power	Compressor Power (Integer Value with 1 implied decimal) - Compressor #6	AO	17	30017	AO_01_SC[16]	WR_AO_01_SC[16]
Chiller External Load Limiting	Chiller External Load Limiting (Integer Value with 1 implied decimal)	AO	18	30018	AO_01_SC[17]	WR_AO_01_SC[17]
Chiller Flow Setpoint	Chiller Flow Control Setpoint (Integer Value with implied decimal)	AO	19	30019	AO_01_SC[18]	WR_AO_01_SC[18]
DTC1 Suction Pressure	Suction Pressure (Integer Value with 1 implied decimal) - Compressor #1	AO	20	30020	AO_01_SC[19]	WR_AO_01_SC[19]
DTC2 Suction Pressure	Suction Pressure (Integer Value with 1 implied decimal) - Compressor #2	AO	21	30021	AO_01_SC[20]	WR_AO_01_SC[20]
DTC3 Suction Pressure	Suction Pressure (Integer Value with 1 implied decimal) - Compressor #3	AO	22	30022	AO_01_SC[21]	WR_AO_01_SC[21]
DTC4 Suction Pressure	Suction Pressure (Integer Value with 1 implied decimal) - Compressor #4	AO	23	30023	AO_01_SC[22]	WR_AO_01_SC[22]
DTC5 Suction Pressure	Suction Pressure (Integer Value with 1 implied decimal) - Compressor #5	AO	24	30024	AO_01_SC[23]	WR_AO_01_SC[23]
DTC6 Suction Pressure	Suction Pressure (Integer Value with 1 implied decimal) - Compressor #6	AO	25	30025	AO_01_SC[24]	WR_AO_01_SC[24]
ChillerStatus1	Separated into bits - Alarms and Faults	AO	26	30026	AO_01[25]	WR_AO_01[25]
ChillerStatus2	Separated into bits - Alarms and Faults	AO	27	30027	AO_01[26]	WR_AO_01[26]
Spare Unscaled Data 1		AO	28	30034	AO_01[33]	WR_AO_01[33]
Spare Unscaled Data 2		AO	29	30035	AO_01[34]	WR_AO_01[34]
DTC1 Compressor State	Compressor State (see Details Page for State Enumeration) - Compressor #1	AO	30	30036	AO_01[35]	WR_AO_01[35]
DTC2 Compressor State	Compressor State (see Details Page for State Enumeration) - Compressor #2	AO	31	30037	AO_01[36]	WR_AO_01[36]
DTC3 Compressor State	Compressor State (see Details Page for State Enumeration) - Compressor #3	AO	32	30038	AO_01[37]	WR_AO_01[37]
DTC4 Compressor State	Compressor State (see Details Page for State Enumeration) - Compressor #4	AO	33	30039	AO_01[38]	WR_AO_01[38]
DTC5 Compressor State	Compressor State (see Details Page for State Enumeration) - Compressor #5	AO	34	30040	AO_01[39]	WR_AO_01[39]
DTC6 Compressor State	Compressor State (see Details Page for State Enumeration) - Compressor #6	AO	35	30041	AO_01[40]	WR_AO_01[40]
Available Capacity	Chiller Available Capacity in %	AO	36	30042	AO_01[41]	WR_AO_01[41]
Spare Unscaled Data 3		AO	37	30043	AO_01[42]	WR_AO_01[42]
DTC1 Discharge Pressure	Discharge Pressure (Integer Value with 1 implied decimal) - Compressor #1	AO	38	30044	AO_01_SC[43]	WR_AO_01_SC[43]
DTC2 Discharge Pressure	Discharge Pressure (Integer Value with 1 implied decimal) - Compressor #2	AO	39	30045	AO_01_SC[44]	WR_AO_01_SC[44]
DTC3 Discharge Pressure	Discharge Pressure (Integer Value with 1 implied decimal) - Compressor #3	AO	40	30046	AO_01_SC[45]	WR_AO_01_SC[45]
DTC4 Discharge Pressure	Discharge Pressure (Integer Value with 1 implied decimal) - Compressor #4	AO	41	30047	AO_01_SC[46]	WR_AO_01_SC[46]
DTC5 Discharge Pressure	Discharge Pressure (Integer Value with 1 implied decimal) - Compressor #5	AO	42	30048	AO_01_SC[47]	WR_AO_01_SC[47]

Table 14. BMS analog data listing (continued)

Tag Name	Description	Object Type	Object Id	Modbus Register	EIP Read Tag Name	EIP Write Tag Name
DTC6 Discharge Pressure	Discharge Pressure (Integer Value with 1 implied decimal) - Compressor #6	AO	43	30049	AO_01_SC[48]	WR_AO_01_SC[48]
Spare Scaled Data 1		AO	44	30050	AO_01_SC[49]	WR_AO_01_SC[49]
Spare Scaled Data 2		AO	45	30051	AO_01_SC[50]	WR_AO_01_SC[50]
Chiller Capacity	Chiller Percent Capacity (Integer Value with 1 implied decimal)	AO	46	30052	AO_01_SC[51]	WR_AO_01_SC[51]
DTC1 3-Phase Current	Compressor Current (Integer Value with 1 implied decimal) - Compressor #1	AO	47	30053	AO_01_SC[52]	WR_AO_01_SC[52]
DTC2 3-Phase Current	Compressor Current (Integer Value with 1 implied decimal) - Compressor #2	AO	48	30054	AO_01_SC[53]	WR_AO_01_SC[53]
DTC3 3-Phase Current	Compressor Current (Integer Value with 1 implied decimal) - Compressor #3	AO	49	30055	AO_01_SC[54]	WR_AO_01_SC[54]
DTC4 3-Phase Current	Compressor Current (Integer Value with 1 implied decimal) - Compressor #4	AO	50	30056	AO_01_SC[55]	WR_AO_01_SC[55]
DTC5 3-Phase Current	Compressor Current (Integer Value with 1 implied decimal) - Compressor #5	AO	51	30057	AO_01_SC[56]	WR_AO_01_SC[56]
DTC6 3-Phase Current	Compressor Current (Integer Value with 1 implied decimal) - Compressor #6	AO	52	30058	AO_01_SC[57]	WR_AO_01_SC[57]
Spare Scaled Data 3		AO	53	30059	AO_01_SC[58]	WR_AO_01_SC[58]
Spare Scaled Data 4		AO	54	30060	AO_01_SC[59]	WR_AO_01_SC[59]
DTC1 Suction Temperature	Suction Temperature (Integer Value with 1 implied decimal) - Compressor #1	AO	55	30061	AO_01_SC[60]	WR_AO_01_SC[60]
DTC2 Suction Temperature	Suction Temperature (Integer Value with 1 implied decimal) - Compressor #2	AO	56	30062	AO_01_SC[61]	WR_AO_01_SC[61]
DTC3 Suction Temperature	Suction Temperature (Integer Value with 1 implied decimal) - Compressor #3	AO	57	30063	AO_01_SC[62]	WR_AO_01_SC[62]
DTC4 Suction Temperature	Suction Temperature (Integer Value with 1 implied decimal) - Compressor #4	AO	58	30064	AO_01_SC[63]	WR_AO_01_SC[63]
DTC5 Suction Temperature	Suction Temperature (Integer Value with 1 implied decimal) - Compressor #5	AO	59	30065	AO_01_SC[64]	WR_AO_01_SC[64]
DTC6 Suction Temperature	Suction Temperature (Integer Value with 1 implied decimal) - Compressor #6	AO	60	30066	AO_01_SC[65]	WR_AO_01_SC[65]
Spare Scaled Data 5		AO	61	30067	AO_01_SC[66]	WR_AO_01_SC[66]
Spare Scaled Data 6		AO	62	30068	AO_01_SC[67]	WR_AO_01_SC[67]
Spare Scaled Data 7		AO	63	30075	AO_01_SC[74]	WR_AO_01_SC[74]
Spare Scaled Data 8		AO	64	30076	AO_01_SC[75]	WR_AO_01_SC[75]
DTC1 Discharge Temperature	Discharge Temperature (Integer Value with 1 implied decimal) - Compressor #1	AO	65	30077	AO_01_SC[76]	WR_AO_01_SC[76]
DTC2 Discharge Temperature	Discharge Temperature (Integer Value with 1 implied decimal) - Compressor #2	AO	66	30078	AO_01_SC[77]	WR_AO_01_SC[77]
DTC3 Discharge Temperature	Discharge Temperature (Integer Value with 1 implied decimal) - Compressor #3	AO	67	30079	AO_01_SC[78]	WR_AO_01_SC[78]
DTC4 Discharge Temperature	Discharge Temperature (Integer Value with 1 implied decimal) - Compressor #4	AO	68	30080	AO_01_SC[79]	WR_AO_01_SC[79]
DTC5 Discharge Temperature	Discharge Temperature (Integer Value with 1 implied decimal) - Compressor #5	AO	69	30081	AO_01_SC[80]	WR_AO_01_SC[80]
DTC6 Discharge Temperature	Discharge Temperature (Integer Value with 1 implied decimal) - Compressor #6	AO	70	30082	AO_01_SC[81]	WR_AO_01_SC[81]
Spare Scaled Data 9		AO	71	30083	AO_01_SC[82]	WR_AO_01_SC[82]
Spare Scaled Data 10		AO	72	30084	AO_01_SC[83]	WR_AO_01_SC[83]



Operating Procedures

Table 14. BMS analog data listing (continued)

Tag Name	Description	Object Type	Object Id	Modbus Register	EIP Read Tag Name	EIP Write Tag Name
General Alarm	Chiller General Alarm (1 - New Alarm Exists)	AO	73	30085	AO_01[84]	WR_AO_01[84]
Actual SP	Chiller Actual Setpoint (Integer Value with 1 implied decimal)	AO	74	30086	AO_01_SC[85]	WR_AO_01_SC[85]
Ambient Temperature	Outside Air Temperature	AO	75	30087	AO_01_SC[86]	WR_AO_01_SC[86]
Condenser Fan Speed	Fan Speed Control % Average	AO	76	30088	AO_01_SC[87]	WR_AO_01_SC[87]
ChillerFault1	Chiller Fault word 1	AO	77	30089	AO_01[88]	WR_AO_01[88]
Chiller Flow	Chiller Flow Rate	AO	78	30090	AO_01_SC[89]	WR_AO_01_SC[89]
Chiller Pump Speed	Chiller Pump Speed	AO	79	30091	AO_01_SC[90]	WR_AO_01_SC[90]
ChillerFault2	Chiller Fault word 2	AO	80	30092	AO_01[91]	WR_AO_01[91]
Pump DP	Pump Differential Pressure	AO	81	30093	AO_01_SC[92]	WR_AO_01_SC[92]
FreeCool Valve	FreeCooling Valve Position	AO	82	30094	AO_01_SC[93]	WR_AO_01_SC[93]
Fan Bank 1 State	Fan Bank 1 Fan State	AO	83	30095	AO_01[94]	WR_AO_01[94]
Fan Bank 2 State	Fan Bank 2 Fan State	AO	84	30096	AO_01[95]	WR_AO_01[95]
Fan Bank 3 State	Fan Bank 3 Fan State	AO	85	30097	AO_01[96]	WR_AO_01[96]
Fan Bank 4 State	Fan Bank 4 Fan State	AO	86	30098	AO_01[97]	WR_AO_01[97]
Average SDT	Average SDT Temperature	AO	87	30099	AO_01_SC[98]	WR_AO_01_SC[98]
FreeCool Fan Speed	Free Cooling Fan Speed	AO	88	30100	AO_01_SC[99]	WR_AO_01_SC[99]
FanBankSpeed1	Fan Bank Speed (%) Circuit 1 (Integer Value with 1 implied decimal)	AO	89	30101	AO_01_SC[100]	WR_AO_01_SC [100]
FanBankSpeed2	Fan Bank Speed (%) Circuit 2 (Integer Value with 1 implied decimal)	AO	90	30102	AO_01_SC[101]	WR_AO_01_SC [101]
FanBankSpeed3	Fan Bank Speed (%) Circuit 3 (Integer Value with 1 implied decimal)	AO	91	30103	AO_01_SC[102]	WR_AO_01_SC [102]
FanBankSpeed4	Fan Bank Speed (%) Circuit 4 (Integer Value with 1 implied decimal)	AO	92	30104	AO_01_SC[103]	WR_AO_01_SC [103]
LiquidLineTemp1	Liquid Line Temperature Circuit 1 (Integer Value with 1 implied decimal)	AO	93	30105	AO_01_SC[104]	WR_AO_01_SC [104]
LiquidLineTemp2	Liquid Line Temperature Circuit 2 (Integer Value with 1 implied decimal)	AO	94	30106	AO_01_SC[105]	WR_AO_01_SC [105]
LiquidLineTemp3	Liquid Line Temperature Circuit 3 (Integer Value with 1 implied decimal)	AO	95	30107	AO_01_SC[106]	WR_AO_01_SC [106]
LiquidLineTemp4	Liquid Line Temperature Circuit 4 (Integer Value with 1 implied decimal)	AO	96	30108	AO_01_SC[107]	WR_AO_01_SC [107]
Spare Scaled Data 11		AO	97	30109	AO_01_SC[108]	WR_AO_01_SC [108]
Spare Scaled Data 12		AO	98	30110	AO_01_SC[109]	WR_AO_01_SC [109]
Spare Scaled Data 13		AO	99	30111	AO_01_SC[110]	WR_AO_01_SC [110]
Spare Scaled Data 14		AO	100	30112	AO_01_SC[111]	WR_AO_01_SC [111]
General Alarm Reset	Chiller General Alarm Reset (Send 2 to reset)	AV	101	40113	AO_01_SC[112]	WR_AO_01_SC [112]
Adiabatic Cooling EN	Adiabatic Cooling Enable	AV	102	40114	AO_01_SC[113]	WR_AO_01_SC [113]

Table 14. BMS analog data listing (continued)

Tag Name	Description	Object Type	Object Id	Modbus Register	EIP Read Tag Name	EIP Write Tag Name
Low Noise EN	Enable Fan Low Noise Function	AV	103	40115	AO_01_SC[114]	WR_AO_01_SC [114]
Low Noise Setpoint	Fan Speed Setting for Low Noise	AV	104	40116	AO_01_SC[115]	WR_AO_01_SC [115]
Chiller External Load Limiting	Chiller External Load Limiting (Integer Value with 1 implied decimal)	AV	105	40117	AO_01_SC[116]	WR_AO_01_SC [116]
Chiller Flow Setpoint	Chiller Flow Control Setpoint (Integer Value with implied decimal)	AV	106	40118	AO_01_SC[117]	WR_AO_01_SC [117]
Chiller Setpoint	Chiller Setpoint from BMS (Integer Value with 1 implied decimal)	AV	107	40119	AO_01_SC[118]	WR_AO_01_SC [118]
Chiller Enable	Chiller Enable from BMS	AV	108	40120	AO_01_SC[119]	WR_AO_01_SC [119]

Table 15. BMS BO Objects: Status, alarms, and faults

Tag Name	Array	Object Type	Instance	Metasys N2 Address	Modbus Register	EIP Read Tag Name	EIP Write Tag Name
DTC1 Fault: Inverter Temperature	DTCFaults	BO	109	1	10001	DTCFaults[0]	WR_DTCFaults[0]
DTC1 Fault: Discharge Temperature	DTCFaults	BO	110	2	10002	DTCFaults[1]	WR_DTCFaults[1]
DTC1 Fault: Suction Pressure	DTCFaults	BO	111	3	10003	DTCFaults[2]	WR_DTCFaults[2]
DTC1 Fault: Discharge Pressure	DTCFaults	BO	112	4	10004	DTCFaults[3]	WR_DTCFaults[3]
DTC1 Fault: 3 Phase Over Current	DTCFaults	BO	113	5	10005	DTCFaults[4]	WR_DTCFaults[4]
DTC1 Fault: Cavity Temperature	DTCFaults	BO	114	6	10006	DTCFaults[5]	WR_DTCFaults[5]
DTC1 Fault: Leaving Air / Water	DTCFaults	BO	115	7	10007	DTCFaults[6]	WR_DTCFaults[6]
DTC1 Fault: Total Compression Ratio Fault	DTCFaults	BO	116	8	10008	DTCFaults[7]	WR_DTCFaults[7]
DTC1 Fault: Generic Bearing Motor Compressor	DTCFaults	BO	117	9	10009	DTCFaults[8]	WR_DTCFaults[8]
DTC1 Fault: Sensor Fault	DTCFaults	BO	118	10	10010	DTCFaults[9]	WR_DTCFaults[9]
DTC1 Fault: SCR Temperature	DTCFaults	BO	119	11	10011	DTCFaults[10]	WR_DTCFaults[10]
DTC1 Fault: Lockout Fault	DTCFaults	BO	120	12	10012	DTCFaults[11]	WR_DTCFaults[11]
DTC1 Fault: Winding Temperature Fault	DTCFaults	BO	121	13	10013	DTCFaults[12]	WR_DTCFaults[12]
DTC1 Fault: Super Heat Fault	DTCFaults	BO	122	14	10014	DTCFaults[13]	WR_DTCFaults[13]
DTC2 Fault: Inverter Temperature	DTCFaults	BO	123	15	10017	DTCFaults[16]	WR_DTCFaults[16]
DTC2 Fault: Discharge Temperature	DTCFaults	BO	124	16	10018	DTCFaults[17]	WR_DTCFaults[17]
DTC2 Fault: Suction Pressure	DTCFaults	BO	125	17	10019	DTCFaults[18]	WR_DTCFaults[18]
DTC2 Fault: Discharge Pressure	DTCFaults	BO	126	18	10020	DTCFaults[19]	WR_DTCFaults[19]
DTC2 Fault: 3 Phase Over Current	DTCFaults	BO	127	19	10021	DTCFaults[20]	WR_DTCFaults[20]
DTC2 Fault: Cavity Temperature	DTCFaults	BO	128	20	10022	DTCFaults[21]	WR_DTCFaults[21]
DTC2 Fault: Leaving Air / Water	DTCFaults	BO	129	21	10023	DTCFaults[22]	WR_DTCFaults[22]
DTC2 Fault: Total Compression Ratio Fault	DTCFaults	BO	130	22	10024	DTCFaults[23]	WR_DTCFaults[23]
DTC2 Fault: Generic Bearing Motor Compressor	DTCFaults	BO	131	23	10025	DTCFaults[24]	WR_DTCFaults[24]
DTC2 Fault: Sensor Fault	DTCFaults	BO	132	24	10026	DTCFaults[25]	WR_DTCFaults[25]
DTC2 Fault: SCR Temperature	DTCFaults	BO	133	25	10027	DTCFaults[26]	WR_DTCFaults[26]
DTC2 Fault: Lockout Fault	DTCFaults	BO	134	26	10028	DTCFaults[27]	WR_DTCFaults[27]
DTC2 Fault: Winding Temperature Fault	DTCFaults	BO	135	27	10029	DTCFaults[28]	WR_DTCFaults[28]



Operating Procedures

Table 15. BMS BO Objects: Status, alarms, and faults (continued)

Tag Name	Array	Object Type	Instance	Metasys N2 Address	Modbus Register	EIP Read Tag Name	EIP Write Tag Name
DTC2 Fault: Super Heat Fault	DTCFaults	BO	136	28	10030	DTCFaults[29]	WR_DTCFaults[29]
DTC3 Fault: Inverter Temperature	DTCFaults	BO	137	29	10033	DTCFaults[32]	WR_DTCFaults[32]
DTC3 Fault: Discharge Temperature	DTCFaults	BO	138	30	10034	DTCFaults[33]	WR_DTCFaults[33]
DTC3 Fault: Suction Pressure	DTCFaults	BO	139	31	10035	DTCFaults[34]	WR_DTCFaults[34]
DTC3 Fault: Discharge Pressure	DTCFaults	BO	140	32	10036	DTCFaults[35]	WR_DTCFaults[35]
DTC3 Fault: 3 Phase Over Current	DTCFaults	BO	141	33	10037	DTCFaults[36]	WR_DTCFaults[36]
DTC3 Fault: Cavity Temperature	DTCFaults	BO	142	34	10038	DTCFaults[37]	WR_DTCFaults[37]
DTC3 Fault: Leaving Air / Water	DTCFaults	BO	143	35	10039	DTCFaults[38]	WR_DTCFaults[38]
DTC3 Fault: Total Compression Ratio Fault	DTCFaults	BO	144	36	10040	DTCFaults[39]	WR_DTCFaults[39]
DTC3 Fault: Generic Bearing Motor Compressor	DTCFaults	BO	145	37	10041	DTCFaults[40]	WR_DTCFaults[40]
DTC3 Fault: Sensor Fault	DTCFaults	BO	146	38	10042	DTCFaults[41]	WR_DTCFaults[41]
DTC3 Fault: SCR Temperature	DTCFaults	BO	147	39	10043	DTCFaults[42]	WR_DTCFaults[42]
DTC3 Fault: Lockout Fault	DTCFaults	BO	148	40	10044	DTCFaults[43]	WR_DTCFaults[43]
DTC3 Fault: Winding Temperature Fault	DTCFaults	BO	149	41	10045	DTCFaults[44]	WR_DTCFaults[44]
DTC3 Fault: Super Heat Fault	DTCFaults	BO	150	42	10046	DTCFaults[45]	WR_DTCFaults[45]
DTC4 Fault: Inverter Temperature	DTCFaults	BO	151	43	10049	DTCFaults[48]	WR_DTCFaults[48]
DTC4 Fault: Discharge Temperature	DTCFaults	BO	152	44	10050	DTCFaults[49]	WR_DTCFaults[49]
DTC4 Fault: Suction Pressure	DTCFaults	BO	153	45	10051	DTCFaults[50]	WR_DTCFaults[50]
DTC4 Fault: Discharge Pressure	DTCFaults	BO	154	46	10052	DTCFaults[51]	WR_DTCFaults[51]
DTC4 Fault: 3 Phase Over Current	DTCFaults	BO	155	47	10053	DTCFaults[52]	WR_DTCFaults[52]
DTC4 Fault: Cavity Temperature	DTCFaults	BO	156	48	10054	DTCFaults[53]	WR_DTCFaults[53]
DTC4 Fault: Leaving Air / Water	DTCFaults	BO	157	49	10055	DTCFaults[54]	WR_DTCFaults[54]
DTC4 Fault: Total Compression Ratio Fault	DTCFaults	BO	158	50	10056	DTCFaults[55]	WR_DTCFaults[55]
DTC4 Fault: Generic Bearing Motor Compressor	DTCFaults	BO	159	51	10057	DTCFaults[56]	WR_DTCFaults[56]
DTC4 Fault: Sensor Fault	DTCFaults	BO	160	52	10058	DTCFaults[57]	WR_DTCFaults[57]
DTC4 Fault: SCR Temperature	DTCFaults	BO	161	53	10059	DTCFaults[58]	WR_DTCFaults[58]
DTC4 Fault: Lockout Fault	DTCFaults	BO	162	54	10060	DTCFaults[59]	WR_DTCFaults[59]
DTC4 Fault: Winding Temperature Fault	DTCFaults	BO	163	55	10061	DTCFaults[60]	WR_DTCFaults[60]
DTC4 Fault: Super Heat Fault	DTCFaults	BO	164	56	10062	DTCFaults[61]	WR_DTCFaults[61]
DTC5 Fault: Inverter Temperature	DTCFaults	BO	165	57	10065	DTCFaults[64]	WR_DTCFaults[64]
DTC5 Fault: Discharge Temperature	DTCFaults	BO	166	58	10066	DTCFaults[65]	WR_DTCFaults[65]
DTC5 Fault: Suction Pressure	DTCFaults	BO	167	59	10067	DTCFaults[66]	WR_DTCFaults[66]
DTC5 Fault: Discharge Pressure	DTCFaults	BO	168	60	10068	DTCFaults[67]	WR_DTCFaults[67]
DTC5 Fault: 3 Phase Over Current	DTCFaults	BO	169	61	10069	DTCFaults[68]	WR_DTCFaults[68]
DTC5 Fault: Cavity Temperature	DTCFaults	BO	170	62	10070	DTCFaults[69]	WR_DTCFaults[69]
DTC5 Fault: Leaving Air / Water	DTCFaults	BO	171	63	10071	DTCFaults[70]	WR_DTCFaults[70]
DTC5 Fault: Total Compression Ratio Fault	DTCFaults	BO	172	64	10072	DTCFaults[71]	WR_DTCFaults[71]
DTC5 Fault: Generic Bearing Motor Compressor	DTCFaults	BO	173	65	10073	DTCFaults[72]	WR_DTCFaults[72]

Table 15. BMS BO Objects: Status, alarms, and faults (continued)

Tag Name	Array	Object Type	Instance	Metasys N2 Address	Modbus Register	EIP Read Tag Name	EIP Write Tag Name
DTC5 Fault: Sensor Fault	DTCFaults	BO	174	66	10074	DTCFaults[73]	WR_DTCFaults[73]
DTC5 Fault: SCR Temperature	DTCFaults	BO	175	67	10075	DTCFaults[74]	WR_DTCFaults[74]
DTC5 Fault: Lockout Fault	DTCFaults	BO	176	68	10076	DTCFaults[75]	WR_DTCFaults[75]
DTC5 Fault: Winding Temperature Fault	DTCFaults	BO	177	69	10077	DTCFaults[76]	WR_DTCFaults[76]
DTC5 Fault: Super Heat Fault	DTCFaults	BO	178	70	10078	DTCFaults[77]	WR_DTCFaults[77]
DTC6 Fault: Inverter Temperature	DTCFaults	BO	179	71	10081	DTCFaults[80]	WR_DTCFaults[80]
DTC6 Fault: Discharge Temperature	DTCFaults	BO	180	72	10082	DTCFaults[81]	WR_DTCFaults[81]
DTC6 Fault: Suction Pressure	DTCFaults	BO	181	73	10083	DTCFaults[82]	WR_DTCFaults[82]
DTC6 Fault: Discharge Pressure	DTCFaults	BO	182	74	10084	DTCFaults[83]	WR_DTCFaults[83]
DTC6 Fault: 3 Phase Over Current	DTCFaults	BO	183	75	10085	DTCFaults[84]	WR_DTCFaults[84]
DTC6 Fault: Cavity Temperature	DTCFaults	BO	184	76	10086	DTCFaults[85]	WR_DTCFaults[85]
DTC6 Fault: Leaving Air / Water	DTCFaults	BO	185	77	10087	DTCFaults[86]	WR_DTCFaults[86]
DTC6 Fault: Total Compression Ratio Fault	DTCFaults	BO	186	78	10088	DTCFaults[87]	WR_DTCFaults[87]
DTC6 Fault: Generic Bearing Motor Compressor	DTCFaults	BO	187	79	10089	DTCFaults[88]	WR_DTCFaults[88]
DTC6 Fault: Sensor Fault	DTCFaults	BO	188	80	10090	DTCFaults[89]	WR_DTCFaults[89]
DTC6 Fault: SCR Temperature	DTCFaults	BO	189	81	10091	DTCFaults[90]	WR_DTCFaults[90]
DTC6 Fault: Lockout Fault	DTCFaults	BO	190	82	10092	DTCFaults[91]	WR_DTCFaults[91]
DTC6 Fault: Winding Temperature Fault	DTCFaults	BO	191	83	10093	DTCFaults[92]	WR_DTCFaults[92]
DTC6 Fault: Super Heat Fault	DTCFaults	BO	192	84	10094	DTCFaults[93]	WR_DTCFaults[93]
DTC1 Alarm: Inverter Temperature	DTCAlarms	BO	193	85	10101	DTCAlarms[0]	WR_DTCAlarms[0]
DTC1 Alarm: Discharge Temperature	DTCAlarms	BO	194	86	10102	DTCAlarms[1]	WR_DTCAlarms[1]
DTC1 Alarm: Suction Pressure	DTCAlarms	BO	195	87	10103	DTCAlarms[2]	WR_DTCAlarms[2]
DTC1 Alarm: Discharge Pressure	DTCAlarms	BO	196	88	10104	DTCAlarms[3]	WR_DTCAlarms[3]
DTC1 Alarm: 3 Phase Current	DTCAlarms	BO	197	89	10105	DTCAlarms[4]	WR_DTCAlarms[4]
DTC1 Alarm: Shaft / Cavity Temperature	DTCAlarms	BO	198	90	10106	DTCAlarms[5]	WR_DTCAlarms[5]
DTC1 Alarm: Leaving Water Temperature	DTCAlarms	BO	199	91	10107	DTCAlarms[6]	WR_DTCAlarms[6]
DTC1 Alarm: Total Compression Ratio	DTCAlarms	BO	200	92	10108	DTCAlarms[7]	WR_DTCAlarms[7]
DTC1 Alarm: SCR Temperature	DTCAlarms	BO	201	93	10109	DTCAlarms[8]	WR_DTCAlarms[8]
DTC1 Alarm: Super Heat Alarm	DTCAlarms	BO	202	94	10114	DTCAlarms[13]	WR_DTCAlarms[13]
DTC2 Alarm: Inverter Temperature	DTCAlarms	BO	203	95	10117	DTCAlarms[16]	WR_DTCAlarms[16]
DTC2 Alarm: Discharge Temperature	DTCAlarms	BO	204	96	10118	DTCAlarms[17]	WR_DTCAlarms[17]
DTC2 Alarm: Suction Pressure	DTCAlarms	BO	205	97	10119	DTCAlarms[18]	WR_DTCAlarms[18]
DTC2 Alarm: Discharge Pressure	DTCAlarms	BO	206	98	10120	DTCAlarms[19]	WR_DTCAlarms[19]
DTC2 Alarm: 3 Phase Current	DTCAlarms	BO	207	99	10121	DTCAlarms[20]	WR_DTCAlarms[20]
DTC2 Alarm: Shaft / Cavity Temperature	DTCAlarms	BO	208	100	10122	DTCAlarms[21]	WR_DTCAlarms[21]
DTC2 Alarm: Leaving Water Temperature	DTCAlarms	BO	209	101	10123	DTCAlarms[22]	WR_DTCAlarms[22]
DTC2 Alarm: Total Compression Ratio	DTCAlarms	BO	210	102	10124	DTCAlarms[23]	WR_DTCAlarms[23]
DTC2 Alarm: SCR Temperature	DTCAlarms	BO	211	103	10125	DTCAlarms[24]	WR_DTCAlarms[24]
DTC2 Alarm: Super Heat Alarm	DTCAlarms	BO	212	104	10130	DTCAlarms[29]	WR_DTCAlarms[29]



Operating Procedures

Table 15. BMS BO Objects: Status, alarms, and faults (continued)

Tag Name	Array	Object Type	Instance	Metasys N2 Address	Modbus Register	EIP Read Tag Name	EIP Write Tag Name
DTC3 Alarm: Inverter Temperature	DTCAlarms	BO	213	105	10133	DTCAlarms[32]	WR_DTCAlarms[32]
DTC3 Alarm: Discharge Temperature	DTCAlarms	BO	214	106	10134	DTCAlarms[33]	WR_DTCAlarms[33]
DTC3 Alarm: Suction Pressure	DTCAlarms	BO	215	107	10135	DTCAlarms[34]	WR_DTCAlarms[34]
DTC3 Alarm: Discharge Pressure	DTCAlarms	BO	216	108	10136	DTCAlarms[35]	WR_DTCAlarms[35]
DTC3 Alarm: 3 Phase Current	DTCAlarms	BO	217	109	10137	DTCAlarms[36]	WR_DTCAlarms[36]
DTC3 Alarm: Shaft / Cavity Temperature	DTCAlarms	BO	218	110	10138	DTCAlarms[37]	WR_DTCAlarms[37]
DTC3 Alarm: Leaving Water Temperature	DTCAlarms	BO	219	111	10139	DTCAlarms[38]	WR_DTCAlarms[38]
DTC3 Alarm: Total Compression Ratio	DTCAlarms	BO	220	112	10140	DTCAlarms[39]	WR_DTCAlarms[39]
DTC3 Alarm: SCR Temperature	DTCAlarms	BO	221	113	10141	DTCAlarms[40]	WR_DTCAlarms[40]
DTC3 Alarm: Super Heat Alarm	DTCAlarms	BO	222	114	10146	DTCAlarms[45]	WR_DTCAlarms[45]
DTC4 Alarm: Inverter Temperature	DTCAlarms	BO	223	115	10149	DTCAlarms[48]	WR_DTCAlarms[48]
DTC4 Alarm: Discharge Temperature	DTCAlarms	BO	224	116	10150	DTCAlarms[49]	WR_DTCAlarms[49]
DTC4 Alarm: Suction Pressure	DTCAlarms	BO	225	117	10151	DTCAlarms[50]	WR_DTCAlarms[50]
DTC4 Alarm: Discharge Pressure	DTCAlarms	BO	226	118	10152	DTCAlarms[51]	WR_DTCAlarms[51]
DTC4 Alarm: 3 Phase Current	DTCAlarms	BO	227	119	10153	DTCAlarms[52]	WR_DTCAlarms[52]
DTC4 Alarm: Shaft / Cavity Temperature	DTCAlarms	BO	228	120	10154	DTCAlarms[53]	WR_DTCAlarms[53]
DTC4 Alarm: Leaving Water Temperature	DTCAlarms	BO	229	121	10155	DTCAlarms[54]	WR_DTCAlarms[54]
DTC4 Alarm: Total Compression Ratio	DTCAlarms	BO	230	122	10156	DTCAlarms[55]	WR_DTCAlarms[55]
DTC4 Alarm: SCR Temperature	DTCAlarms	BO	231	123	10157	DTCAlarms[56]	WR_DTCAlarms[56]
DTC4 Alarm: Super Heat Alarm	DTCAlarms	BO	232	124	10162	DTCAlarms[61]	WR_DTCAlarms[61]
DTC5 Alarm: Inverter Temperature	DTCAlarms	BO	233	125	10165	DTCAlarms[64]	WR_DTCAlarms[64]
DTC5 Alarm: Discharge Temperature	DTCAlarms	BO	234	126	10166	DTCAlarms[65]	WR_DTCAlarms[65]
DTC5 Alarm: Suction Pressure	DTCAlarms	BO	235	127	10167	DTCAlarms[66]	WR_DTCAlarms[66]
DTC5 Alarm: Discharge Pressure	DTCAlarms	BO	236	128	10168	DTCAlarms[67]	WR_DTCAlarms[67]
DTC5 Alarm: 3 Phase Current	DTCAlarms	BO	237	129	10169	DTCAlarms[68]	WR_DTCAlarms[68]
DTC5 Alarm: Shaft / Cavity Temperature	DTCAlarms	BO	238	130	10170	DTCAlarms[69]	WR_DTCAlarms[69]
DTC5 Alarm: Leaving Water Temperature	DTCAlarms	BO	239	131	10171	DTCAlarms[70]	WR_DTCAlarms[70]
DTC5 Alarm: Total Compression Ratio	DTCAlarms	BO	240	132	10172	DTCAlarms[71]	WR_DTCAlarms[71]
DTC5 Alarm: SCR Temperature	DTCAlarms	BO	241	133	10173	DTCAlarms[72]	WR_DTCAlarms[72]
DTC5 Alarm: Super Heat Alarm	DTCAlarms	BO	242	134	10178	DTCAlarms[77]	WR_DTCAlarms[77]
DTC6 Alarm: Inverter Temperature	DTCAlarms	BO	243	135	10181	DTCAlarms[80]	WR_DTCAlarms[80]
DTC6 Alarm: Discharge Temperature	DTCAlarms	BO	244	136	10182	DTCAlarms[81]	WR_DTCAlarms[81]
DTC6 Alarm: Suction Pressure	DTCAlarms	BO	245	137	10183	DTCAlarms[82]	WR_DTCAlarms[82]
DTC6 Alarm: Discharge Pressure	DTCAlarms	BO	246	138	10184	DTCAlarms[83]	WR_DTCAlarms[83]
DTC6 Alarm: 3 Phase Current	DTCAlarms	BO	247	139	10185	DTCAlarms[84]	WR_DTCAlarms[84]
DTC6 Alarm: Shaft / Cavity Temperature	DTCAlarms	BO	248	140	10186	DTCAlarms[85]	WR_DTCAlarms[85]
DTC6 Alarm: Leaving Water Temperature	DTCAlarms	BO	249	141	10187	DTCAlarms[86]	WR_DTCAlarms[86]
DTC6 Alarm: Total Compression Ratio	DTCAlarms	BO	250	142	10188	DTCAlarms[87]	WR_DTCAlarms[87]
DTC6 Alarm: SCR Temperature	DTCAlarms	BO	251	143	10189	DTCAlarms[88]	WR_DTCAlarms[88]
DTC6 Alarm: Super Heat Alarm	DTCAlarms	BO	252	144	10194	DTCAlarms[93]	WR_DTCAlarms[93]

Table 15. BMS BO Objects: Status, alarms, and faults (continued)

Tag Name	Array	Object Type	Instance	Metasys N2 Address	Modbus Register	EIP Read Tag Name	EIP Write Tag Name
Chiller: Evaporator Flow Fault	ChillerFaults	BO	253	145	10201	ChillerFaults[0]	WR_ChillerFaults[0]
Chiller: Condenser Flow Fault	ChillerFaults	BO	254	146	10202	ChillerFaults[1]	WR_ChillerFaults[1]
Chiller: Communication Fault	ChillerFaults	BO	255	147	10203	ChillerFaults[2]	WR_ChillerFaults[2]
Chiller: Evaporator Flow Fault with DPS	ChillerFaults	BO	256	148	10204	ChillerFaults[3]	WR_ChillerFaults[3]
Chiller: Condenser Flow Fault with DPS	ChillerFaults	BO	257	149	10205	ChillerFaults[4]	WR_ChillerFaults[4]
Chiller: Fan Fault FB1	ChillerFaults	BO	258	150	10206	ChillerFaults[5]	WR_ChillerFaults[5]
Chiller: Fan Fault FB2	ChillerFaults	BO	259	151	10207	ChillerFaults[6]	WR_ChillerFaults[6]
Chiller: Fan Fault FB3	ChillerFaults	BO	260	152	10208	ChillerFaults[7]	WR_ChillerFaults[7]
Chiller: Fan Fault FB4	ChillerFaults	BO	261	153	10209	ChillerFaults[8]	WR_ChillerFaults[8]
Chiller: HeatTrace Fault	ChillerFaults	BO	262	154	10210	ChillerFaults[9]	WR_ChillerFaults[9]
Chiller: Adiabatic System Fault	ChillerFaults	BO	263	155	10211	ChillerFaults[10]	WR_ChillerFaults[10]
Chiller: Spare Fault 1	ChillerFaults	BO	264	156	10212	ChillerFaults[11]	WR_ChillerFaults[11]
Chiller: Spare Fault 2	ChillerFaults	BO	265	157	10213	ChillerFaults[12]	WR_ChillerFaults[12]
Chiller: Spare Fault 3	ChillerFaults	BO	266	158	10214	ChillerFaults[13]	WR_ChillerFaults[13]
Chiller: Spare Fault 4	ChillerFaults	BO	267	159	10215	ChillerFaults[14]	WR_ChillerFaults[14]
Chiller: Spare Fault 5	ChillerFaults	BO	268	160	10216	ChillerFaults[15]	WR_ChillerFaults[15]
Chiller: Evaporator Pump1 Fault	ChillerFaults	BO	269	161	10217	ChillerFaults[16]	WR_ChillerFaults[16]
Chiller: Evaporator Pump1 Flow Alarm	ChillerFaults	BO	270	162	10218	ChillerFaults[17]	WR_ChillerFaults[17]
Chiller: Evaporator Pump2 Fault	ChillerFaults	BO	271	163	10219	ChillerFaults[18]	WR_ChillerFaults[18]
Chiller: Evaporator Pump2 Flow Alarm	ChillerFaults	BO	272	164	10220	ChillerFaults[19]	WR_ChillerFaults[19]
Chiller: No Chiller Pump Available	ChillerFaults	BO	273	165	10221	ChillerFaults[20]	WR_ChillerFaults[20]
Chiller: Condenser Pump1 Fault	ChillerFaults	BO	274	166	10222	ChillerFaults[21]	WR_ChillerFaults[21]
Chiller: Condenser Pump1 Flow Alarm	ChillerFaults	BO	275	167	10223	ChillerFaults[22]	WR_ChillerFaults[22]
Chiller: Condenser Pump2 Fault	ChillerFaults	BO	276	168	10224	ChillerFaults[23]	WR_ChillerFaults[23]
Chiller: Condenser Pump2 Flow Alarm	ChillerFaults	BO	277	169	10225	ChillerFaults[24]	WR_ChillerFaults[24]
Chiller: No Condenser Pump Available	ChillerFaults	BO	278	170	10226	ChillerFaults[25]	WR_ChillerFaults[25]
Chiller: Chiller Not Available	ChillerFaults	BO	279	171	10227	ChillerFaults[26]	WR_ChillerFaults[26]
Chiller: No Compressor Available Fault	ChillerFaults	BO	280	172	10228	ChillerFaults[27]	WR_ChillerFaults[27]
Chiller: Spare Fault 6	ChillerFaults	BO	281	173	10229	ChillerFaults[28]	WR_ChillerFaults[28]
Chiller: Spare Fault 7	ChillerFaults	BO	282	174	10230	ChillerFaults[29]	WR_ChillerFaults[29]
Chiller: Spare Fault 8	ChillerFaults	BO	283	175	10231	ChillerFaults[30]	WR_ChillerFaults[30]
Chiller: Spare Fault 9	ChillerFaults	BO	284	176	10232	ChillerFaults[31]	WR_ChillerFaults[31]
Chiller: Evaporator Flow Switch	ChillerStatus	BO	285	177	10301	ChillerStatus[0]	WR_ChillerStatus[0]
Chiller: Condenser Flow Switch	ChillerStatus	BO	286	178	10302	ChillerStatus[1]	WR_ChillerStatus[1]
Chiller: Evaporator Pump Enable	ChillerStatus	BO	287	179	10303	ChillerStatus[2]	WR_ChillerStatus[2]
Chiller: Condenser Pump Enable	ChillerStatus	BO	288	180	10304	ChillerStatus[3]	WR_ChillerStatus[3]
Chiller: Low Lift Active Circuit 1	ChillerStatus	BO	289	181	10305	ChillerStatus[4]	WR_ChillerStatus[4]
Chiller: Low Lift Active Circuit 2	ChillerStatus	BO	290	182	10306	ChillerStatus[5]	WR_ChillerStatus[5]
Chiller: Low Lift Active Circuit 3	ChillerStatus	BO	291	183	10307	ChillerStatus[6]	WR_ChillerStatus[6]
Chiller: Low Lift Active Circuit 4	ChillerStatus	BO	292	184	10308	ChillerStatus[7]	WR_ChillerStatus[7]

Table 15. BMS BO Objects: Status, alarms, and faults (continued)

Tag Name	Array	Object Type	Instance	Metasys N2 Address	Modbus Register	EIP Read Tag Name	EIP Write Tag Name
Chiller: Barrel Isolation Circuit 1	ChillerStatus	BO	293	185	10309	ChillerStatus[8]	WR_ChillerStatus[8]
Chiller: Barrel Isolation Circuit 2	ChillerStatus	BO	294	186	10310	ChillerStatus[9]	WR_ChillerStatus[9]
Chiller: Barrel Isolation Circuit 3	ChillerStatus	BO	295	187	10311	ChillerStatus[10]	WR_ChillerStatus[10]
Chiller: Barrel Isolation Circuit 4	ChillerStatus	BO	296	188	10312	ChillerStatus[11]	WR_ChillerStatus[11]
Chiller: Adiabatic Cooling Active C1	ChillerStatus	BO	297	189	10313	ChillerStatus[12]	WR_ChillerStatus[12]
Chiller: Adiabatic Cooling Active C2	ChillerStatus	BO	298	190	10314	ChillerStatus[13]	WR_ChillerStatus[13]
Chiller: Adiabatic Cooling Active C3	ChillerStatus	BO	299	191	10315	ChillerStatus[14]	WR_ChillerStatus[14]
Chiller: Adiabatic Cooling Active C4	ChillerStatus	BO	300	192	10316	ChillerStatus[15]	WR_ChillerStatus[15]
Chiller: Low Noise Mode Active	ChillerStatus	BO	301	193	10317	ChillerStatus[16]	WR_ChillerStatus[16]
Chiller: At Maximum Capacity	ChillerStatus	BO	302	194	10318	ChillerStatus[17]	WR_ChillerStatus[17]
Chiller: No Compressor Available	ChillerStatus	BO	303	195	10319	ChillerStatus[18]	WR_ChillerStatus[18]
Chiller: Freeze Protection Active	ChillerStatus	BO	304	196	10320	ChillerStatus[19]	WR_ChillerStatus[19]

Note: Chiller control system provides data for up to 6 compressors.

The BMS Listing has the following characteristics:

- Some of the values like temperatures and pressures have an implied decimal place; this means that a value of 450 read from the chiller via BMS interface for Chiller Outlet Temperature, CHIL_OUT_04, means 45.0 °F (in imperial configuration).
- Some values are enumerated integers:
 - Chiller State:

Figure 25. Chiller state map

Integer Value	Label
Invalid	
0	Idle
1	Start
2	Shutdown
3	Restart
4	Operational
5	Stage-In
6	Stage-Out
7	Staging
8	Hand
9	Off
10	NoFlow
11	CommFLT

- Compressor State:

Figure 26. Compressor state map

Integer Value	Label
Invalid	
0	Absent
1	Offline
2	Idle
3	Operational
4	Hold
5	Starting
6	Stopping
7	Retreating
8	Fault
9	Timeout
10	PowerFail
11	PWRRes
12	FRestart

- Fan State:

Figure 27. Fan state map

Integer Value	Label
Invalid	
Off	
On	
0	Off
1	Manual
2	Ready
3	Free Cool
4	Start
5	Cooling

Compressor Staging Valve Control

All compressors Staging Valves controls can be accessed from compressors screen **Main Menu** → **Comp button** → **Staging** button. Controls are available for Tech level HMI users and above.

Each Staging Valve controls consist of two components:

1. Mode selector
2. Valve status light

Figure 28. Staging valves control screen



As per control options, each Staging Valve can be in one of the modes:

1. Off – staging valve is always off regardless of other conditions.
2. On – staging valve is forced on. Used mostly for troubleshooting or maintenance purposes.
3. Auto – staging valve is controlled automatically as compressor cycles through its states.

Compressor Staging Priority

Compressor staging priority defines the order by which the compressors are staged up. By default, this priority is by runtime, but a Tech-Level user can change this priority with the following options:

- Runtime (default selection) – compares the runtimes of the compressors:

- On stage up – the lowest runtime is started.
- On stage down – the highest runtime is stopped.
- Default – Default as a named option refers to the built order of the chiller. For example, compressor labelled Compressor #1 is first on and last off; Compressor labelled Compressor #2 is second on and second last off.
- User – using the following pop-up, the user can define the priority. Once the selections have been made, the user must commit the changes. There can be no duplicates and, user cannot define a priority to compressor that is not on part of the chiller. Any errors to the selection will prevent commit function with suitable messages to user.

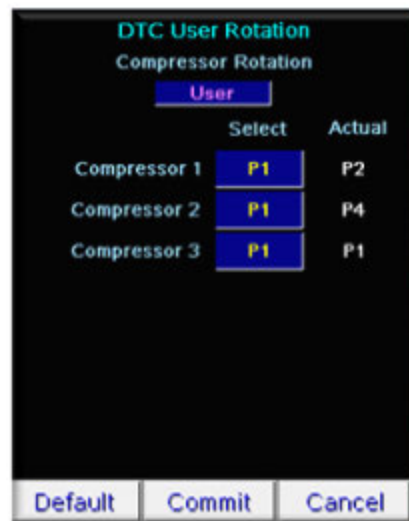

Optional Functionalities

The following table lists the Optional Functionalities of this control system:

Table 16. Chiller control system Optional Functionalities list

Function	Brief	Access Level
Free Cooling	Monitor and Control fan banks (when in free cooling) and free cooling modulation valve functions	Tech
Pump and Plant controls	Monitor and Control evaporator and condenser pumps functions	Tech
Data Logging	Displays chillers / compressors key data logged to CSV files	Admin
Master / Slave	Monitor and Control multiple chillers primary/secondary functions	Tech
Controller option	Select the model of Main Chiller PLC	Admin
Economizer	Monitor and Control compressors economizers functions	Tech
Hot Gas Bypass Valve	Monitor and Control compressors Hot Gas Bypass functions	Tech
Low-Lift Application	Allows chiller to operate at pressure ratios less than 1.5. Adds a refrigerant pump to push liquid refrigerant to compressor motor cooling ports.	Tech

Condenser and Evaporator Duty/Backup Pumps

The chiller control system has two options for pumps control as selected from the HMI configuration page – HMI Pump Control.



- **Disabled** – No pump control from chiller control system. This option must be selected when pumps are not controlled by chiller control system. In that case, BMS operates the pumps.
- **MCX T3C Control** – This pump control mode has been deprecated but maintained in this document for backwards compatibility.

- **Arctic Cool Control** – Requires T3C Companion controller - this is the preferred control methodology. This option must be selected to activate both evaporator/condenser pumps control screens on Devices menu.



Evaporator Pumps

To activate evaporator pumps functionality in the controller, change Evap Pumps Control to display Enabled on the HMI Configuration page. This also activates evaporator pumps control screen.



Table 17. Chiller pump control

Screen	User Interface	Function	Access
Evaporator Pumps Control		<ul style="list-style-type: none"> • Displays trend and current values for Setpoint, Process Value and Control value. Pumps speed is controlled based on: <ul style="list-style-type: none"> – DP - Differential pressure sensor connected to companion controller – dT - Evaporator inlet/outlet temperature delta – T3C dP - Evaporator inlet/outlet pressure delta • Setpoint is tech level adjustable. • Rotation enables Duty/Standby pumps rotation. • Toggle forces Duty/Standby pumps rotation. • To access other settings, click Setup. • Trend has y-axis zoom capability. 	Main Menu > Devices Menu > Pump
Evaporator Pumps Setup		<ul style="list-style-type: none"> • P-Gain and I PID constants. • Max and Min pumps speed settings. • Failover position. Pumps speed when controlled sensor fails. • Pump Count. 1 – only one evaporator pump is controlled. 2 – two pumps Duty/Standby control is active. • Pump Rotation time. When this time elapses Duty pump stops and Standby pump starts. • Flow warning time. If there is no flow for this time while pump is operating, respective pump flow alarm is triggered. • Off delay at switchover. As Duty pumps starts, Standby pump keeps running for this time to ensure flow presence. • Pumps Off Delay. When chiller turns off pump keeps running for this time until compressors come to a complete halt. 	Main Menu > Devices Menu > Pump button > Setup button

Condenser Pumps

To activate condenser pumps control in the controller, set up Cond Pumps Control on the HMI Configuration page to Enabled.

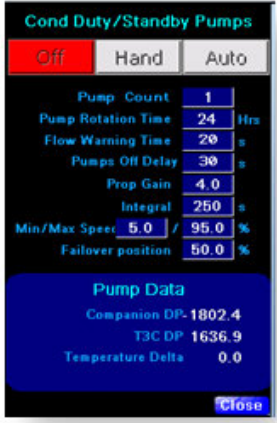

Table 18. Condenser pump controls

Screen	User Interface	Function	Access
Condenser Pumps Control		<ul style="list-style-type: none"> Screen has the same features / capabilities as Evaporator Pumps Control screen (see above). To access other settings click Setup. 	Main Menu > Devices Menu > Pump button > Cond Pump button
Condenser Pumps Setup		<ul style="list-style-type: none"> Has the same set of settings as for the evaporator pumps (see above), except for Run mode. Run mode. <ul style="list-style-type: none"> SystemPumps start/stop along with the chiller enable/disable signal; CompPumps run as long as compressors are operational. 	Main Menu > Devices Menu > Pump button > Cond Pump button > Setup button

Primary/Secondary Control (Chiller Array)

The primary/secondary functionality allows an array on n or n+m chillers to be controlled by one (Primary) controller. Where n is the number of chillers in the array and m is the number of chillers in the array that are designated as **Backup** nodes.

To enable use primary/secondary functionality, click **M/S Enable** button on the HMI Configuration screen to display Enabled.

It also exposes the Master Slave Config screen via **M/S** button.

Figure 29. M/S Enable/Disable button



Table 19. Primary/Secondary chiller management

Screen	User Interface	Function	Access
M/S Enable/Disable		<ul style="list-style-type: none"> The left side of this screen provides the parameters for Primary/Secondary units. The right side of this screen provides status information, that details which nodes are requested to run by the Primary and their actual running capacity. 	Main Menu > Devices Menu > M/S

Economizer Control

The Economizer Control (ECO) provides cooling refrigerant vapour to the interstage port of the Turbocor compressor. The ECO function has the following algorithms:

Table 20. ECO function algorithms

Algorithm	Display Detail
Speed – Enables the ECO function between threshold settings based on relative compressor speed (%). Includes a capacity-based permissive.	
PR (default) – Enables the ECO function between threshold settings based on relative Compressor pressure ratio.	
Capacity – Enables the ECO function between threshold settings based on compressor capacity (%).	

The ECO system has the following control options:

Table 21. ECO control options

Control	Display Detail
Solenoid valves only – source of cooling vapour is external for the control system, very often, it is a brazed plate heat exchanger with TXV – Thermal Expansion Valve (mechanical device).	
Flash Tank – requires an additional level control (modulating device) with PI loop. Mostly implemented on water-cooled chillers. Includes a level permissive that with close the solenoid if level exceeds setting.	
Brazed-Plate – in this case, the heat exchanger is control with EXV and PI loop.	
NoSolenoid_DX – same as above but there are no additional solenoids between ECO and compressor. Requires a DX heat exchanger with EXV and PI loop per compressor.	

While ECO function is enabled (determined by threshold configuration of the selected algorithm), if there is a solenoid valve to the compressor interstage, it is open and if the control option includes an EXV (modulating), it is opened and controlled to specific setpoint for the option.

Economizer valves control option in the controller can be enabled / disabled on HMI Configuration page.



This also reveals economizers control screen at **Main Menu > Devices Menu > ECO**.

As shown above, there are two modulating valve control options:

1. Brazed-plate with an EXV.
2. Flash Tank with a level control.

Brazed-Plate EXV Control

Brazed-Plate EXV control deals with an air-cooled chiller with a complete ECO system per refrigeration circuit. If EXV option is selected, the **ECO EXV** button appears for circuit defined in the chiller.



Clicking the **ECO EXV** button invokes the screen below with following controls.

1. Setpoint – SSH value usually 9 R
2. PI parameters
3. Valve Max and Min output values
4. Requires external pressure and temperature sensors to calculate SSH actual value.
5. Loop Delay – solenoid opens first.

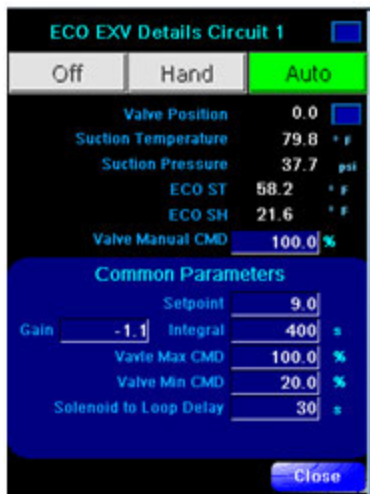

Flash-Tank Level Control

An alternative method of obtaining flash gas is to implement a flash tank. This vessel sits on the liquid line with EXVs both upstream to the condenser and downstream to the evaporator. The upstream EXV is controlled by the standard EXV in Sub Cool mode. The downstream EXV is controlled by the level in the flash tank. Flash tank level is a permissive for the economizer solenoids in so far as if the level is above a threshold (Settable) the valves are closed. This is to prevent liquid refrigerant into the interstage port of the compressor. Flash tank control option also displays **ECO EXV** button which invokes the following pop-up.

1. Flash Tank Level.
2. PI loop parameters.
3. Level Setpoint (default – 25 percent).
4. Valve max and min output values.
5. Loop delay.
6. Flash Tank Max Level (default – 60 percent) – this closes the solenoid valve to prevent liquid refrigerant from entering the interstage port.

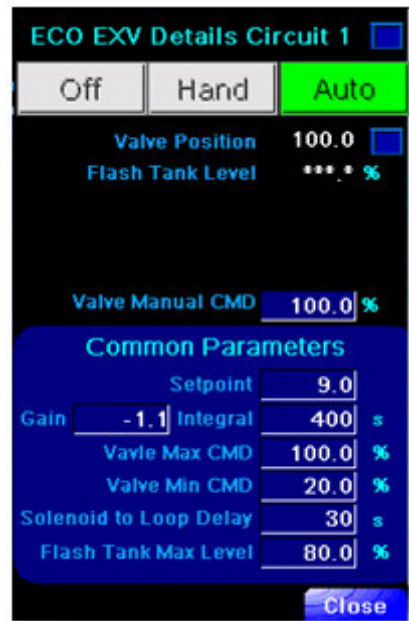

Hot Gas Bypass Valves Control

HMI HGV Control option should be changed to Enabled in order to expose Hot Gas Valve control screen under **Devices Menu**.

Controls accessed on main Hot Gas Bypass valve screen and Setup pop-up screen are common for all Hot Gas Bypass Valves. Controls available on HGVs / Solenoids pop-ups, however are individual for each Hot Gas Bypass Valve.

Figure 30. HMI HGV control enabled screen



Table 22. Hot gas low balancing control

Screen	User Interface	Function	Access
Hot Gas Bypass Valves Control		<ul style="list-style-type: none"> Displays trend and current values for Setpoint, Process Value and Valve position. PV. Chiller LWT. SP. SP = Chiller SP – low urgency zone (refer to Chiller Control Manual) + SP Offset (described below). T3C dP. Evaporator inlet / outlet pressure delta. Trend has y-axis zoom capability. Provides access to other pop-up screens: <ul style="list-style-type: none"> Setup HGVs Solenoids 	Main Menu > Devices Menu > HGV
Hot Gas Bypass Valve Setup		<ul style="list-style-type: none"> SP Offset. Involved in setpoint calculation (see main screen SP description above) P-Gain and I PID constants. 	Main Menu > Devices Menu > HGV button > Setup button.
Hot Gas Bypass Valves Manual Control		<p>Each Hot Gas Bypass valve can be in one of the following modes:</p> <ul style="list-style-type: none"> Auto. Valve controlled automatically by Hot Gas Bypass PID controller (solenoid opens when PID opens the modulating valve) Off. Valve is always off; Manual. Valve position is set up manually. 	Main Menu > Devices Menu > HGV button > HGVs button.

Low-Lift Application

The low-lift application uses a special expanded-map compressor with a refrigerant motor cooling pump. With a standard lift compressor, motor cooling is dependent on a pressure of 1.5 or better to push liquid refrigerant into the cooling ports of the compressors. In Low-Lift, the refrigerant pump pushes the liquid refrigerant into the cooling ports allowing for the chiller to drop the pressure ratio to ~1. This low-pressure ratio leads to near free-cooling efficiencies.

This function is enabled by mode selection.



- Disabled** – No operation.
- Motor Cooling** – Function provides cooling to compressor motor only.
- Split System** – Function provides both motor cooling and flow boost to EXV.

This section focuses on the motor cooling mode of the low-lift application. In this mode, the controller looks at the pressure ratio and uses a threshold setpoint to enable the function as a permissive. The refrigerant pump is controlled by the same threshold values that the compressor uses to open its own motor cooling valves.

Inputs

- Compressor pressure ratio
- Inverter Temperature
- Cavity Temperature
- Compressor Run. – Compressor must be running to use this function.

Parameters

- Pressure Ratio Threshold** – If the pressure ratio drops below this value, then this permissive is satisfied. There is a built-in hysteresis of 0.2.

- **Temperature Enable Threshold** – When either the inverter or cavity temperature exceeds this value and the pressure ratio permissive is satisfied, the pump is started. Confirm this value matches the settings in the compressor.
- **Temperature Disable Threshold** – When both the inverter and cavity temperature drop below this value then the pump stops. Confirm this value matches the settings in the compressor.
- **Anti-Cycle Time** – This value keeps the pump from cycling too often.

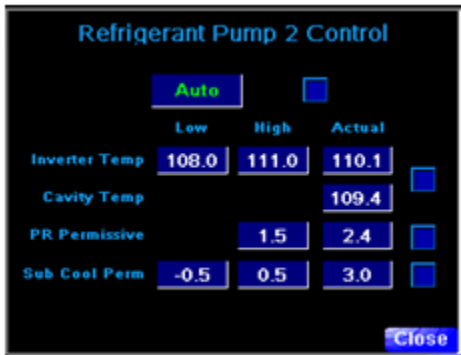

Outputs

Pump Command

Refrigerant Pump for Split Systems

The refrigerant pump operates differently in a split system compared to straight motor cooling mode. In the split system mode, the pressure ratio is the keep signal - the pump runs whenever the pressure threshold is met. This mode also works in conjunction with a bypass valve which is open when the pump is off and closed when the pump is on.

Barrel Isolation

The chiller system can also manage multiple fluid circuits. A four-compressor/ four-circuit air-cooled chiller generally has two evaporator barrels. To optimize the system, the controller only opens the barrel where compressors are running, and the other barrel(s) are closed. This revision of software can manage four separate fluid circuits.

Barrel isolation valves are controlled at an admin-user level from the HMI configuration page.

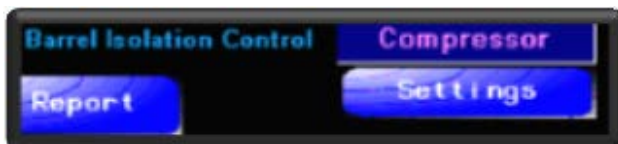

Following options are available.

- **Disabled** – No control of isolation from the controller.
- **Compressor** – Any compressor that is assigned to a circuit and is running, opens the isolation valve for that circuit.

- **Cooling EN** – All isolation valves are open when chiller is enabled.

When either Compressor or Cooling EN selected, the Settings button is available. Click **Settings** to display the following.

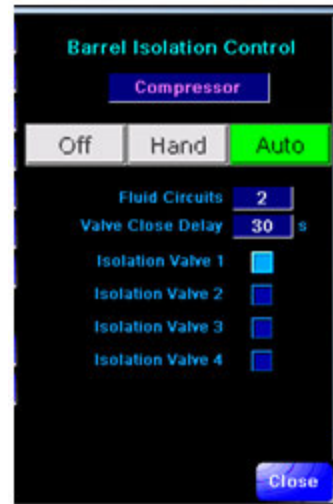

- **HOA Control** – Same as any other HOA control except only one for the whole system. Manual opens all isolation valves. In auto, valves operate independently.
- **Circuit Configuration** – This will generate an error if the number of compressors on each circuit is not equal.
- **Valve Close Delay** – Keeps valve open for the time Setting after fluid no longer required.
- **Status of each Valve**

Security Configuration

The **TACW** Chiller control system has following 3 levels of security:

- User:
 - Automatic Logon.
 - View all main pages.
 - Can turn chiller on / off.
 - Can change user chilled water setpoint.
 - No access to Settings and Devices screens.
- Tech:
 - User is responsible for day-to-day maintenance of the chiller.
 - Has full access to Devices screens but no access to Settings screens.
- Admin:
 - Full Access.

Note: Both Admin and Tech users must log on using the button on the main screen and provide their username and password in the user login screen.

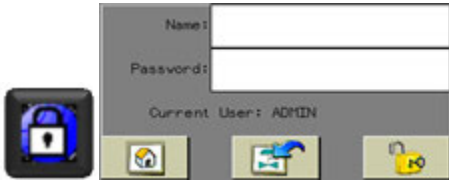

Alarm Handling

There are two alarms lists that can be accessed on the HMI:

- Main alarms list - It encompasses all the alarms/faults that affect compressors/chiller operation and have to be handled by the operator.
- Diagnostics alarms list - It displays all the diagnostics messages and is used for preventive/troubleshooting purposes. It can be accessed by Admin user only.

Main Alarms List



Access: **Main Menu > Alarm.**

It lists all the current/acknowledged/reset alarms. When an alarm occurs, a new message appears in RED on the alarm screen.

All entries must be acknowledged with these buttons (see below). This turns the entry YELLOW.



1. Press and hold the **Reset** button on the screen for 10 seconds. Any alarm condition that is clear will turn GREEN. Any condition that is still yellow means the condition still exists.
2. When all alarm entries on the alarm screen are green, press the **Delete** button.



Diagnostics Alarm List



Access: **Main Menu > Setup Menu > HMI > Alarm.**

Diagnostics alarms are handled in the same fashion as main list alarms.

Apart from alarms list, the screen displays other chiller diagnostic parameters.

Note: Do not delete the list if Yellow or Red.

Operator Tasks

Before operating the unit, ensure that all compressor refrigeration service valves are fully back-seated counterclockwise and all valves are in the open position.

Normal Power Up

The following procedure is used for a startup resulting from scheduled seasonal or programmed cold shutdown of the chiller.

⚠ WARNING

Hazardous Voltage!

Failure to disconnect power before servicing could result in death or serious injury.

Disconnect all electric power, including remote disconnects before servicing. Follow proper lockout/tagout procedures to ensure the power can not be inadvertently energized. Verify that no power is present with a voltmeter.

Important: This start-up procedure is not to be used for the first-time initial startup for a newly installed chiller.

1. De-energize the chiller using standard lockout/tagout procedures.
2. Using a known operational voltage meter, test and confirm the chiller is de-energized before proceeding further.
3. Inspect power distribution fuses and overload settings to verify they are correct.
4. Restore power.
5. Inspect refrigerant pressures using the touchscreen interface panel.
6. Verify pressures correlate using manifold gauges.

7. Verify chilled water flow to condenser and evaporator.
8. Monitor and record temperature and refrigerant pressures registering on the touchscreen interface panel.

Emergency Power Shutdown

The chiller includes a disconnect to turn off the high voltage to the unit. Should an emergency condition arise, the disconnect must be opened to shutdown all voltage to the chiller.

There are several ways to interrupt power to all or part of the chiller:

- Disconnect the primary power source from the building that feeds electricity to the chiller. This occurs in sudden emergencies (usually weather-related) or planned maintenance shutdowns.
- Press the HOA button to access the OFF button. Press the OFF button to disable the module. The HOA button is located on the touchscreen of the unit.
- Each chiller has a toggle switch located on the exterior of the power panel. This switch is used to isolate power in the control panel.

Note: Pressing the HOA button on the touchscreen interface panel does not de-energize the chiller or the high voltage current into the chillers control panel. This action sends a command to the controller to discontinue electrical current to that compressor.

Water Quality Guidelines

Water quality must be maintained periodically by the end user to avoid scaling and corrosion inside the heat exchangers.

NOTICE

Proper Water Treatment Required!

The use of untreated or improperly treated water could result in scaling, erosion, corrosion, algae or slime.

Use the services of a qualified water treatment specialist to determine what water treatment, if any, is required. Trane assumes no responsibility for equipment failures which result from untreated or improperly treated water, or saline or brackish water.

Table 23. Water quality guidelines

Element/Compound/Property	Value/Unit
pH	7.5 - 9.0
Conductivity	< 500 µS/cm
Total Hardness	4.5 - 8.5 dH°
Free Chlorine	< 1.0 ppm
Ammonia (NH ₃)	< 0.5 ppm
Sulphate (SO ₄ ²⁻)	< 100 ppm
Hydrogen Carbonate (HCO ₃ ⁻)	60 – 200 ppm
(HCO ₃ ⁻) / (SO ₄ ²⁻)	> 1.5
(Ca + Mg) / (HCO ₃ ⁻)	> 0.5
Chloride (Cl ⁻)	< 200 ppm

Notes:

1. *Total Hardness/corrosion: Water with high hardness can cause corrosion problems due to its high ion content (Ca²⁺, Mg²⁺, Fe²⁺) which also means a high electrical conductivity and a high total dissolved solid (TDS). For this reason, too high hardness values should be avoided, not only due to higher risk of scaling, but also for corrosion risk. On the other hand, soft water, but not necessarily cation exchange softened water, may in contrast have a low buffering capacity and so be more corrosive. If the hardness values are outside the recommended range, other parameters such as oxygen content, conductivity, and pH values should be considered to evaluate the corrosion risk.*
2. *Fe³⁺ and Mn⁴⁺ are strong oxidants and may increase the risk for localized corrosion on stainless steels in combination with brazing material copper.*

Monitor Water Quality

Maintaining water/glycol mixture quality and cleanliness is critical to chiller health and maintainability. Water/glycol mixture samples should be taken and tested by a professional lab. The results will enable the accurate

adjustment of quality thereby increasing the operational life of the chiller.

Note: Trane will not validate the chiller warranty if the proper water/glycol mixture composition and quality is not maintained.

Maintain Glycol Level

When the chiller has a water set point that is below the freezing point of the water/glycol in use, take precautions against freezing.

The glycol concentration should be based on the lowest fluid design temperature. See [Table 25, p. 63](#) provides guidelines for adding propylene glycol.

Table 24. Glycol performance impact factors

Range Factor	Glycol Concentration Percentages and Performance Impact					
Propylene Glycol Concentration	30%		40%		50%	
Lowest Ambient Temperature	10 °F (-12 °C)		-4 °F (-10 °C)		-20 °F (-29 °C)	
Recommended Minimum Leaving Fluid Temperature	25 °F (-4 °C)		10 °F (-12 °C)		-10 °F (-23 °C)	
Leaving Temperature	Capacity Reduction Factor	Pressure Drop Factor	Capacity Reduction Factor	Pressure Drop Factor	Capacity Reduction Factor	Pressure Drop Factor
70 °F (21 °C)	0.96	1.27	0.93	1.43	0.91	1.63
60 °F (15.6 °C)	0.95	1.31	0.92	1.47	0.90	1.68
55 °F (13 °C)	0.95	1.31	0.92	1.50	0.89	1.73
50 °F (10 °C)	0.94	1.33	0.91	1.51	0.88	1.75

A 20% to 50% solution of glycol should be added to prevent pipe corrosion regardless of the fluid temperature. Propylene glycol has corrosion inhibitors that protect piping and components from corrosion and buildup of rust and other deposits. Trane recommends against using water/glycol solution in excess of 50% regardless of the ambient temperature conditions.

inactive as they could rupture due to expansion during cold weather or low refrigerant pressure.

In order to maintain a high-quality glycol solution, the water used in the glycol mixture must have very few impurities. Impurities in the water can increase metal corrosion, aggravate pitting of cast iron and steel, reduce the effectiveness of the corrosion inhibitors, and increase the depletion rate of the inhibitor package.

To assure inhibitor effectiveness, the levels of chlorides and sulfates in the water should not exceed 25 ppm each. The total hardness in terms of calcium carbonate should be less than 100 ppm. For best long-term results, de-ionized or distilled water is recommended.

NOTICE

Equipment Damage!

Failure to follow instructions below could result in permanent damage to pump and internal cooling surfaces.

Do not use automotive antifreeze.

Note: If glycol-free solutions are mandated at the chiller site, special inhibitors are available for rust prevention, mineral deposit inhibition, and biological suppression. Adding these inhibitors to the water solution is strongly recommended.

Heaters, heat tracing cable, and closed cell insulation can be installed on any exposed "wet" chiller components for protection against freezing in low ambient temperature and low refrigerant pressure conditions. However, the best freeze prevention is using the appropriate concentration of glycol. Trane does not warranty any component that fails due to freezing.

Prevent Freezing

Many liquids expand in volume upon cooling. This expansion may cause pipes and other enclosed systems containing a liquid to rupture or burst when exposed to low temperature conditions. Burst protection is needed to protect piping and other enclosed systems when they are

Propylene Glycol

Glycol-based fluids provide such burst protection in water solutions due to their low freezing points. As a glycol-based fluid cools below the solution's freezing point, ice crystals begin to form, and the remaining solution becomes more concentrated in glycol. This ice/water/glycol mixture results in a flowable slush, and remains fluid, even as the temperature continues to cool.

The fluid volume increases as this slush forms and the temperature cools, flowing into available expansion volume in the chiller. If the concentration of glycol is sufficient, no damage to the chiller from fluid expansion should occur within the temperature range indicated in . When liquids are cooled, they eventually either crystallize like ice or become increasingly viscous until they fail to flow and set up like glass. The first type of behavior represents true freezing. The second is known as super-cooling.

Glycols do not have sharp freezing points. Under normal conditions, propylene glycol sets to a glass-like solid, rather than freezing.

The addition of glycol to water yields a solution with a freezing point below that of water. This has led to the extensive use of glycol-water solutions as cooling media at temperatures appreciably below the freezing point of water. Instead of having sharp freezing points, glycol-water solutions become slushy during freezing. As the temperature falls, the slush becomes more and more viscous and finally fails to flow.

Table 25. Freeze and burst protection chart

Water/Glycol Temperature	Freeze Protection	Burst Protection
20 °F (-7 °C)	18% glycol mixture	12% glycol mixture
10 °F (-12 °C)	29% glycol mixture	20% glycol mixture
0 °F (-17.8 °C)	36% glycol mixture	24% glycol mixture
-10 °F (-23 °C)	42% glycol mixture	28% glycol mixture
-20 °F (-29 °C)	46% glycol mixture	30% glycol mixture

The precise concentration of glycol for a particular chiller is affected by several key factors such as ambient temperature extremes, entering and leaving water temperatures, and chiller size. A chillers optimum glycol concentration is modified by these considerations as reflected in [Table 24, p. 62](#). These capacity correction factors are the **best informed estimates** for chiller with copper evaporators. The percentages may vary depending on the materials and alloys of the heat exchangers, total surface area, the amount of present or future fouling, and the brand of glycol used.

Storage Provisions

The chiller controls are designed for storage in ambient temperatures from -20 °F (-29 °C) to 145 °F (63 °C) with relative humidity from 0% to 100%. The glycol should be

removed from the chiller if the unit is to be stored for extended periods. Although fluids can be drained via the plug in the bottom of the evaporator, the inhibitors in an approved glycol solution will best protect the surfaces of the evaporator against oxidation if the glycol remains inside the chiller during storage.

Figure 31. Water/Glycol concentration freezing points (in degrees Fahrenheit)

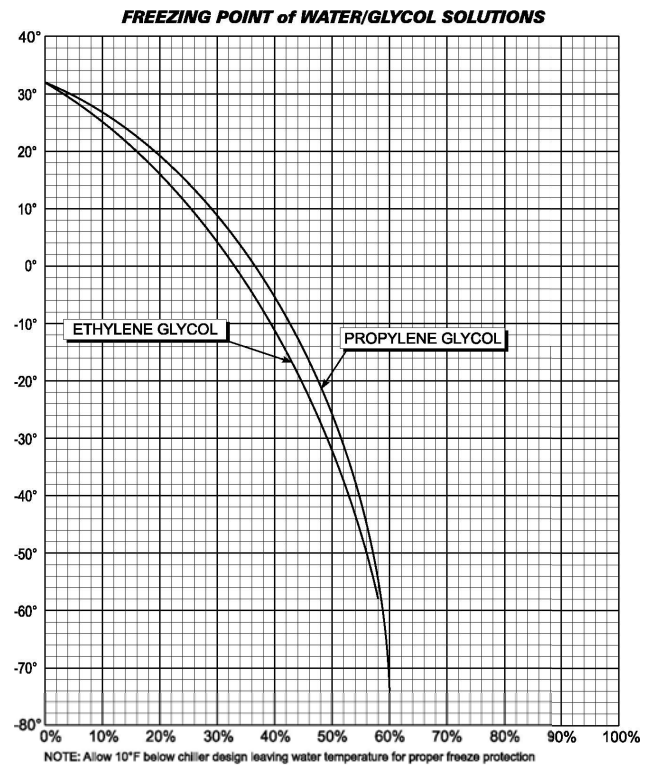



Unit Controls

The control system is comprised of PLC, HMI and BMS interface device. All unit controls and devices have been factory installed and tested prior to shipment. The control circuit incorporates all major safety devices and control features for optimum performance and reliability. Display screen will indicate status of all equipment and parameters. Any fault in the system can be detected without any manual intervention.

Chiller Controller

Mechanical chilling is controlled via T3C and Companion Controller (both are Danfoss MCX products). This Danfoss refrigeration controller is specifically designed to work with the turbocor oil-less compressors in the most efficient manner. All I/O and Setpoints are displayed on a Schneider HMI.

Freeze Protection

The freeze control senses the temperature of the chilled water outlet from the evaporator. It shuts down the module, enables pumps, and opens any isolation valves under the control of the module if abnormally low water temperature is reached (factory set based on freezing point of chilled or condenser fluid).

Flow Switch

A flow switch is a safety device which prevents the unit from operating with little or no water flow.

NOTICE

Proof of Flow Switch!

Failure to provide flow switches or jumping-out of switches could result in severe equipment damage. Evaporator and condenser water circuits require proof of flow switches.

- **Failure to include the proof of flow devices and/or jumping out these devices could cause the unit to stop on a secondary level of protection.**
- **Frequent cycling on these higher level diagnostic devices could cause excessive thermal and pressure cycling of unit components (O-rings, gaskets, sensors, motors, controls, etc.) and/or freeze damage, resulting in premature failure of the chiller.**

Temperature Control

The temperature transducers sense the return chilled water temperature, and the controller monitors this signal and cycles the refrigeration system to maintain accurate process water temperature. The set point can be changed using HMI.

Electronic Expansion Valves

The Electronic Expansion Valve (EXV) is a metering device that automatically controls the flow of refrigerant to the evaporator based on superheat/sub-cooling. The EXV allows operation at low condensing pressures/temperatures and saves energy by increasing the efficiency of the chiller through precise superheat/sub-cooling control.



Sequence of Operations

The Chiller Sequence of Operations (SOO) has two components.

1. Main Sequence
2. Supplemental Sequences

Main Sequence

When chiller starts from Idle state.

1. Enable signal sent from BAS either by:
 - a. Setting a Normally Open (NO) digital input on chiller control to true.

NO open contact needs to close to disable. This provides an emergency backup function where the loss of the BMS and resulting loss of signal enables the chiller.
 - b. BMS can set chiller to enable via BMS interface too.
2. Chiller is set to Cooling Enable.
3. If the chiller has control, pumps are started, and isolation valves are opened or . Otherwise, chiller waits for flow.
 - a. If no flow – announce No Flow Alarm.
 - b. Continue to wait for flow.
4. If the LCHWT is greater than or equal to the chiller temperature setpoint plus the Low Urgency Zone (LUZ) setpoint for the LUZ time (default – 30 seconds), start up conditions are met and there are compressors available to run, the chiller is set to Start state.
5. The lead available compressor(s) interlock is closed, and 65 percent (settable) demand is sent.
 - a. Compressor priority is either:
 - Compressor order (left to right), or
 - Determined by runtime
 - User Settable
 - b. Compressor state set to Starting.

Note: *The T3C application has a Delta Start parameter the examines LCHWT against Setpoint. It divides the difference by the parameter generating an integer compressor start count. So, on chiller start with LCHWT of 74°F, a Setpoint of 62°F and the Delta Start parameter is 4, the chiller control takes the difference (74 - 62 = 12) and divides by the parameter (12 ÷ 4 = 3) and automatically starts 3 compressors (if available) on the Chiller.*
6. Once the selected compressor(s) is(are) started up, the compressor and chiller states become Operational. The chiller controller drives the chiller to setpoint using an embedded PI-Loop.
7. If the chiller, enters the LUZ then control is by PI-Loop.
8. If chiller is above LUZ and power consumption above settable threshold for the LUZ time, chiller enters

Stage-In. This state has the following steps:

- a. Demand is reduced to the Running compressors until stage in Pressure Ratio is achieved. Compressors state is Retreating. Once PR achieved State is Hold.

Note: *On Pressure Ratio chiller start, there is a setting in the control that monitors the running PR. It varies by configuration and type of chiller. It is designed to keep compressor on the same refrigerant circuit from disabling each other. Since TACW design dictates that compressors do not share refrigerant circuits, this value is 4.0 by default. This means that under normal circumstances the TACW chiller should not display Retreating State and go directly to Hold.*

- b. While maintaining Hold on running compressors, next priority compressor is marked Start and is send start demand.
 - c. When start up conditions on new compressor are met, the chiller and all running compressors are marked Operational.
9. If chiller drops below LUZ for the LUZ time, the chiller will want to Stage-Out.
 - a. To stage out there must be more than one compressor running. Priority compressor is sent a demand of 0 percent and is marked Stopping. When compressor has reached 0 rpm and IGV is back to idle position the compressor is marked idle and the chiller returns to Operational.
 - b. If only one compressor is running and the PI-Loop cannot maintain Setpoint at minimum demand and there is no Hot Gas Bypass Valve (Load Balancing - HGBV), the chiller goes to Shutdown, the last compressor is sent 0% demand and is marked Stopping.
 - c. If chiller equipped with HGBV then the HGBV valve opens, introduces artificial load to the system and tries to maintain setpoint without cycling off the chiller.
 10. After shutdown complete, chiller and compressors are marked Idle.

Supplemental Sequences

This section discusses control sequences that work in conjunction with the main sequence or may work in the background. These fall into three categories:

1. Device Sequences
2. Chiller protection
3. Optional Sequences

Device Sequences

The chiller uses the following devices as part of the chiller process.

1. EXV device.
2. Fan Bank device.
3. Economizer device.
4. Low-Lift Refrigerant Pump.
5. Hot Gas Load Balancing device.
6. Pumping.
7. Fluid and Refrigerant isolation device.

All devices in the chiller control system have Hand-Off-Auto functionality:

- **Hand** – user takes control of the device from the HMI or equivalent interface.
- **Off** – the device is inactive regardless of the state of the chiller control system:
- **Auto** – device is available to the chiller control sequences.

Note: All devices must be in auto mode for proper chiller operation.

Electronic Expansion Valve (EXV) Sequence

The EXV is a per refrigeration circuit device and operates when any compressor on the circuit is running and this software handles up to four independent refrigeration circuits. The software includes a selection of algorithms to control the EXV. The factory and Trane Technologies technicians set the algorithm to best suit your conditions and configuration. The algorithms for control are:

- **Suction Superheat (SSH)** – can work with sensors on the evaporator or the internal sensors on the compressors. If no barrel sensors are available, the system defaults to compressor internals. This is default for TACW chillers. Setpoint is a function of capacity.
- **Discharge Superheat (DSH)** – like SSH, this algorithm works with compressor internal or external sensors. Very stable method for chiller control but cannot be used in conjunction with economizers. Setpoint is a constant.
- **SubCooling (SC)** – uses the liquid line temperature sensor with either compressor saturated discharge temperature of external pressure sensor converted to temperature. Setpoint is a function of capacity.
- **Liquid Level** – can work with either high pressure side or low pressure side with appropriate level sensor. This algorithm is mostly for backward compatibility with 1st generation TACW units.

The following is the sequence of operations for an EXV.

1. All Compressors on refrigeration circuit Idle, Valve Closed.
2. Any Compressor Starting – Valve to Start Position (Settable Parameter).

3. All compressors on refrigerant circuit to Operational – Valve PID controlled to setpoint. Valve position subject to Max and Min position parameter settings.
4. If during EXV normal function, a low SST signal occurs, the valve will rapidly open to avoid Fault.

PID and all other parameters are configurable with appropriate credentials (Tech).

Fan Bank Sequence

The fans on a TACW chiller are arranged by fan bank, where a fan bank serves an individual refrigerant circuit. This software does not control individual fans. Like the EXV, this software can control up to four fan banks and does include several different algorithms designed to get the best from your chiller. The fan control algorithms are:

- **Ambient** – Fan SDT setpoint is a function of Ambient temperature with an approach setting. The SDT setpoint value is subject to the Max and Min SDT setpoint parameters.
- **Capacity** – Fan SDT setpoint is a function of capacity within the bounds of Max and Min SDT setpoint parameters.
- **Ambient with Capacity** – (Default) SDT setpoint is a function of both Ambient Temperature with approach and capacity within the bounds of Max and Min SDT setpoint parameters.
- **Speed** – SDT Setpoint is a function of compressor relative speed to Surge and Choke. It is design to keep the compressor at its most efficient.
- **Low-Lift** – SDT setpoint is a function of pressure ratio (PR) between a Max and Min PR parameter. This is not a selectable function but engages automatically at low-lift conditions.

The following is the sequence of operations for a fan bank.

1. Circuit Idle (all compressors on the circuit are Idle), Fan Bank speed value is 0 percent - Off.
2. Any Compressor on circuit Starting, Fan Bank speed set to Start Speed parameter.
3. All compressors on circuit Operational, fan bank speed is PID controlled to the SDT setpoint.
4. Circuit Stopping going to Idle, Fan Bank speed set to Fans Off Speed parameter. Fan Bank stays a Fans Off Speed for the duration of the Fans Off Delay parameter then Fan Bank speed to 0 percent - Off.

PID and all other parameters are configurable with appropriate credentials (Tech).

Economizer

The software provides the economizer function on a per compressor basis and is therefore, capable of six independent economizer controls. The software can control the various economizer options following:

1. **Flash tank** – controls a solenoid per compressor and a circuit shared flash tank level.

2. **Direct Expansion with TXV** – controls a solenoid per compressor.
3. **Direct Expansion with EXV** – controls a solenoid per compressor and EXV per circuit with Suction Superheat control.
4. **Direct Expansion with no solenoid** – Assume DX with EXV per compressor. EXV controlled to Suction Superheat setpoint.

The Economizer function has the following algorithms.

1. **Speed** – uses relative speed of the compressor to decide when to engage the economizer.
2. **Pressure Ratio (Default)** – uses Pressure Ratio to decide when to engage.
3. **Capacity** – uses capacity calculation to decide when to engage.

The following is the sequence of operations for the Economizer (ECO) function: Control signal is based on Algorithm selected.

1. Compressor Idle, ECO is Off, all valves are closed.
2. Compressor Operational and controlling signal rises above the engage threshold, ECO system is engaged.
 - a. ECO solenoid is open and EXV is controlled by PID loop to appropriate Setpoint (Flash Tank Level – default 25 percent; DX SSH – Default 9 R.

Note: *Flash Tank program includes tank over full setting which automatically closes solenoid to prevent liquid refrigerant being introduced into interstage of the compressor.*

3. Compressor Operational and controlling drops below the disengage threshold, ECO system is disengaged.
4. Compressor Stopping, Fault, Offline, Absent – ECO System is Off.

PID and all other parameters are configurable with appropriate credentials (Tech).

Low-Lift Refrigerant Pump

The system includes optional liquid refrigerant pump to operate during conditions of low-lift to provide motor cooling. Under normal conditions, the compressor relies on lift (PR > 1.5) to drive motor cooling but with the assist of the refrigerant pump the chiller can run at PR < 1.5, leading to greater efficiencies.

The low-lift liquid refrigerant pump has the following algorithms.

1. **Motor (Default)** – the system looks at compressor inverter and cavity temperatures with pressure ratio (PR) as a permissive.
2. **Pressure Ratio** – for split systems, pump is controlled by PR exclusively to provide motor cooling and keep liquid refrigerant flowing to EXV.

The following is the sequence of operations for the low-lift liquid refrigerant pump:

1. Compressor Operational.

2. If Pressure Ratio (PR) drops below Engage Threshold, System is considered in Low-Lift condition. For PR mode, pump always runs while low-lift is true.
3. If low-lift condition true and if either temperature is greater than the compressor cooling valve open temperature (typically 111 °F) then run pump.
4. Pump runs until both temperatures are below the compressor cooling valve close temperature (typically, 108 °F) then pump stops.
5. The system includes a (default 30 second) anti-cycle timer for the pump.
6. If the PR rise above disengage threshold, the system is no longer considered in low lift.

PID and all other parameters are configurable with appropriate credentials (Tech).

Hot Gas Load Balancing

In low-load conditions, the system can keep the chiller from cycling by introducing hot gas into the evaporator, giving the chiller a false load. Care must be taken when setting the parameters for the Hot Gas Load Balancing (HGBV) function to engage the HCBV system before the conditions for shutdown are met.

The following is the sequence of operations for HGBV.

1. Chiller operational with only one compressor running.
2. LCHWT drops less than setpoint and a small offset less than LUZ stage out offset. HGBV system is engaged:
 - a. Running compressor's HGBV solenoid opens, and the appropriate modulating valve opens and controls to setpoint with PID Loop.
3. Any other chiller conditions – the HGBV system is disengaged, and all valves are closed.

PID and all other parameters are configurable with appropriate credentials (Tech).

Pumping

The system includes pumping control. It allows for duty/stand-by control of up to two VFD pumps with automatic switch-over and rotation.

This pump system can be applied to chiller pumping (all chillers) and condensing pumping (water-cooled chillers). Pumping is enabled to the following signals.

- System On.
- Cooling Enable.
- Compressor Run (condensing pumping only).

A VFD pump can be controlled with different signals as well.

- Flow.
- Differential Pressure (DP).
- Delta Temperature (DT) .
- 2-Speed control – accommodates multiple fluid circuits.

Sequence of Operations

- Pass-Through – this accepts a signal from another source, likely the BMS, and sends this value directly to the pump.

The following is the sequence of operations for pumping.

1. Pumping Enable.
2. Enable Pump.
 - a. VFD control with PID for flow, DP, and DT.
 - b. 2-Speed – 1 barrel, Low Speed- 2 barrels, or free cooling – high speed.
 - c. Pass-through – send value.
3. **Monitor flow** – No Flow:
 - a. Mark pump unavailable.
 - b. Annunciate alarm to HMI.
 - c. Switch to alternate pump.
 - d. If no pumps available, annunciate No Pump Available alarm.
4. **Monitor Pump Fault** – Pump in Fault:
 - a. Annunciate Pump Fault.
 - b. Mark pump unavailable.
 - c. Switch to alternate pump.
 - d. If no pumps available, annunciate No Pump Available alarm.

Fluid and Refrigerant isolation

The chiller is configured in circuits and each compressor is assigned to a circuit. When a compressor starts, this system confirms that the valve for that circuit is open.

Chiller Operational States

Figure 32. Chiller operational states flow chart

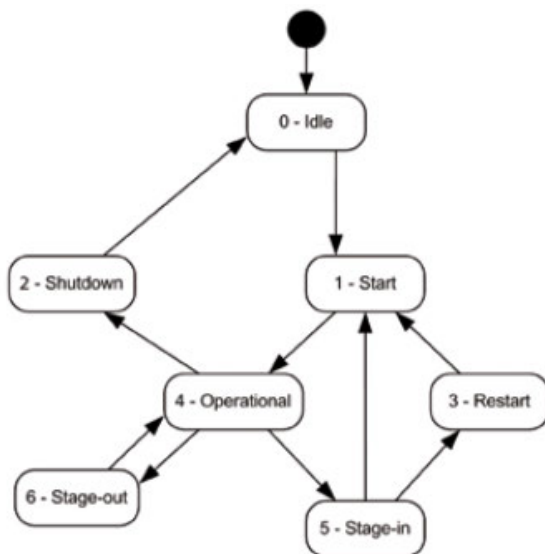

Idle State

The chiller is standing idle (zero capacity) but is ready for start of the first compressor.

Start State

The pressure ratio must be kept low while one or more compressors are in the process of starting. The start state maintains the low-pressure ratio until all running compressors have reached sufficient speed to operate without risk of surging. At that point, the state is changed into the operational state.

Operational State

The chiller is in normal operation.

Stage-In State

Starting a compressor when other compressors are already running requires some care because the pressure ratio has to be low enough to start a compressor.

This is the purpose of the stage-in state. The system is instructed to lower the pressure ratio and the rack controller contributes by instructing all running compressors to reduce their capacity. As soon as the pressure ratio has reached the threshold, the new compressor is instructed to start and the state changes into start state.

Restart State

It is assumed in the stage-in state that the pressure ratio will come down below the threshold where another compressor can be started. However, it must also be assumed that this is not always the case (although this should not happen in a well-designed system unless it is malfunctioning). In that case, all compressors will be stopped and restarted together with one additional compressor. In the restart state, all compressors are signaled to stop. As soon as they have all reached full stop, the controller signals start to all compressors that need to be started and switches into the start state.

Stage-out State

In the stage-out state, one compressor is instructed to stop in order to reduce capacity. When it has reached full stop, the state switches automatically back to the operational state.

Shutdown State

The shutdown state is similar to the stage-out state with the sole exception that in this case the last running compressor is being stopped. The shutdown state therefore switches into the idle stage when this compressor reaches full stop.

Compressor Control States

Figure 33. Compressor control states flow chart

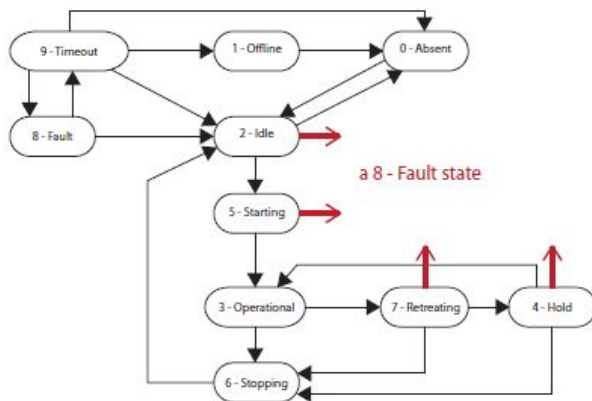

Absent State

A chiller may contain less than the maximum allowed number of compressors. This leaves some of the state machines unused and uninitialized. This is indicated by the absent state.

Offline State

The offline state indicates that the compressor is not to be started. This can be due to three reasons:

1. The operator has taken the compressor offline for maintenance.
2. The compressor encountered a fault state which cannot be recovered by the controller (the operator needs to recycle the power manually).
3. The controller lost its Modbus connection to the compressor.

Idle State

The compressor is currently idle but it is online and ready for use.

Starting State

The compressor has received a start demand and is in the process of speeding up. The state automatically switches into the operational state when the compressor reaches sufficient speed to operate normally without risk of surging.

Operational State

The compressor is in normal operation.

Stopping State

The compressor has received a stop signal and is in the process of slowing down. The state automatically switches into the idle state when the compressor reaches full stop.

Retreating State

Compressors cannot be started against a high-pressure ratio. Thus, it is sometimes necessary to bring the pressure ratio down before another compressor can be started.

It is advisable to do this as quickly as possible so that the interruption of the normal operation is reduced to a minimum. This involves the entire chiller (for example utilizing condenser and bypass valves).

The compressors that are already running can help by reducing their power as much as possible. This is implemented as the retreating state: power is reduced as long as the pressure ratio is too high to start another compressor. It automatically switches into the hold state as soon as the threshold is reached.

Hold State

The compressor keeps running at low power after the retreating state has changed into the hold state. It returns to normal operation after the new compressor has been started (i.e. when it has reached its operational state).

Fault State

The compressor has shut itself down after it detected a fault. The controller attempts to clear the fault, with three possible outcomes:

1. The fault is reset, and the compressor is made available for normal use again by switching into the idle state.
2. After overheating faults (motor or electronics have become too hot), the compressor is given some extra time to cool down by changing into the timeout state. This ensures that the compressor cools down well below its alarm threshold before it can be started again.
3. Some faults cannot be reset by the controller, for example when the compressor is damaged. The controller then takes this compressor out of circulation by switching into the offline state.

Timeout State

The compressor has recovered from an overheat fault. It is given some additional time to cool down before it becomes available.

Power Failure

Indication when a power failure has been detected. All other faults and alarms are suppressed and cleared.

Power Restore

Main power has been restored, if Fast Restart enabled, system will begin the process.

Fast Restart

Fast Restart is enabled, compressors that were running are started again.



Maintenance Procedures

Maintenance Strategy

The primary goal of preventive maintenance is to avoid the consequences of failure of equipment. This may be by preventing the failure before it actually occurs which preventive maintenance helps to achieve. It is designed to preserve and restore equipment reliability by replacing worn components before they actually fail. In addition, operators can record equipment operating conditions, temperatures, and pressures so they know to replace, or repair worn parts before they cause chiller failure. The ideal maintenance program predicts and prevents unnecessary and costly repairs and chiller down time. Trane chillers are designed for ease of access with a premium placed on locating key components to facilitate visual inspection and hands-on verification.

Maintenance for HVAC equipment and facilities can include a **preventive maintenance checklist** which includes small checks which can significantly extend service life.

Power Disconnect Handle

Packaged TACW units are equipped with a panel-mounted disconnect handle installed on the outside of the power distribution panel. The disconnect handle must be turned to the off position before the panel can be opened for service. When the panel door is open, power can be reconnected by turning the handle located on the inside of the panel to the ON position.

⚠ WARNING

PPE for Arc/Flash Required!

Failure to wear appropriate PPE could result in death or serious injury.

On this unit, if the handle shield is cracked the circuit breaker could arc/flash when reset. To avoid being injured, technicians **MUST** put on all necessary Personal Protective Equipment (PPE), in accordance with NFPA70E for arc/flash protection, PRIOR to entering the starter panel cabinet.

NOTICE

Component Damage!

Failure to follow instructions could damage sensitive electronic components beyond repair.

To prevent arcing or surges of electrical current, do not use wires or cables to jump components or bypass the manufacturer's safety systems.

Federal Clean Air Act

Responsible refrigerant practices are important to the environment, our customers, and the air conditioning industry. All technicians who handle refrigerants must be properly certified. The Federal Clean Air Act prescribes procedures for handling, reclaiming, recovering, and recycling of refrigerants and the equipment that must be

used in maintenance procedures involving potential leakage of HVAC refrigerants. State and local governments may have additional requirements that must be followed to responsibly handle HVAC refrigerants.

Inspection and Maintenance Schedule

Proactive measures should be taken to prevent potential problems with the chillers. These include maintaining an operational log and conducting weekly, quarterly, and annual inspections of the chiller.

Inspection Methods

Appropriate inspection for modern chillers can be described as **hands on**. Where possible and appropriate, visual inspection should include touching the component or apparatus being inspected. The sense of touch provides additional feedback regarding temperature, texture, tightness, and dryness that **eyes only** inspection cannot match. Habitually touching each item to be inspected also ensures that items are not subconsciously skipped during the inspection process.

Maintenance Checklist

Spring - Major Inspection

- Cleaning condenser tubes using the appropriate equipment designed for tube punching.
- Connect to the compressors using the proper software and perform routine maintenance checks.
- Remove panels from compressors and physically check electrical components for wear and tear.
- Inspect all electrical panels and components for wear and tear.
- Check and verify all safeties.
- Calibrate Temperature sensors.
- Perform proper leak check on chillers and tag.
- Check operation of automatic valves on chiller.
- Extract logs from chiller and clean SD card (if data logging is enabled).

Spring - Minor Inspection

- Check physical condition of chiller e.g. insulation, compressors, valves, sensors, etc. for damage.
- Check for excessive vibration caused from external sources.
- Insure all electrical connections are secure.
- Verify operation of IGVs.
- Verify operation of EXVs.
- Verify operation of level sensors (if chiller has one).

- Verify operation of staging valves.
- Verify system operation by recording chiller operation e.g. sub-cooling, superheat, water temps, etc.

Winter - Major Inspection

- Cleaning condenser tubes using the appropriate equipment designed for tube punching.
- Connect to the compressors using the proper software and perform routine maintenance checks.
- Remove panels from compressors and physically check electrical components for wear and tear.
- Inspect all electrical panels and components for wear and tear.
- Check and verify all safeties.
- Calibrate temperature sensors.
- Perform proper leak check on chillers and tag.
- Check operation of automatic valves on Chiller.
- Extract logs from chiller and clean SD card.

Maintenance Schedule

⚠ WARNING

Hazardous Voltage!
 Failure to disconnect power before servicing could result in death or serious injury.
 Disconnect all electric power, including remote disconnects before servicing. Follow proper lockout/tagout procedures to ensure the power can not be inadvertently energized. Verify that no power is present with a voltmeter.

⚠ WARNING

Refrigerant under High Pressure!
 Failure to follow instructions below could result in an explosion which could result in death or serious injury or equipment damage.
 System contains refrigerant under high pressure. Recover refrigerant to relieve pressure before opening the system. See unit nameplate for refrigerant type. Do not use non-approved refrigerants, refrigerant substitutes, or refrigerant additives.

Table 26. Maintenance schedule

Task	Daily	Quarterly	Bi-annually	Annually	Other
General Inspection					
Check physical condition of chiller e.g. Insulation, compressors, valves, sensors, etc.		X			
Check Chiller for excessive vibration caused from external sources.		X			
Check for oil in the system. Chiller must operate in an oil free environment. ^(a)				X	
Verify external components are in working order e.g. Cooling towers, Pumps, Air handlers, Water valves etc.		X			
Verify chilled/condenser water pressure gauges and record data.	X				
Chiller Inspection					
Clean condenser and/or evaporator using appropriate equipment designed for tube punching (perform as needed) air cooled chillers require condenser cleaning.				X	
Check the integrity of the evaporator and condenser tubes once every 5 years or as needed. ^(b)					X
Verify condenser water and chilled water pressure drops to insure proper flow (use flow meter for better accuracy)		X			
Compressor Inspection					
Connect to the compressors using the Service Monitoring Tools software and download event and fault logs, create yenta file recordings. Review and save logs for future reference. ^(c)		X			
Using the proper software, perform bearing calibrations to verify compressor performance (save calibration reports for proof).				X	
Using the proper software, verify all adjustable settings are accurate to your application via air/water cooled		X			
Check DC bus voltages on compressors.				X	



Maintenance Procedures

Table 26. Maintenance schedule (continued)

Task	Daily	Quarterly	Bi-annually	Annually	Other
Ensure all communication cables are secure.		X			
Ensure all electronic modules are secure.		X			
Check physical condition of all exposed printed circuit boards (PCBs).			X		
Check all exposed PCBs for dust build-up and clean if necessary.			X		
Check discharge and suction pressure/temperature sensors for accuracy against calibrated pressure/temperature gauges.				X	
Re-apply Gel Lanoline to connections suggested by Turbocor once every 2 years to protect against moisture buildup.					X
Electrical Inspection					
Verify that all electrical connections on chiller are tight.			X		
Check and record main power supply voltage to chiller and each compressor.			X		
Check for signs of hot spots/discoloration on power cables, line reactors, distribution blocks and any other connection point.		X			
Check amperages during operation are as per design.	X				
Check for damaged/stripped wires (around panel doors, casings, pinch points).				X	
Check operation of all system safety devices and interlocks.			X		
Calibrate temperature sensors.			X		
Refrigeration Inspection					
Check system for leaks using an electronic leak detector.			X		
Replace relief valves as per your local codes or once every 5 years.					X
Verify operation of compressor IGV's, EXV's, Hot Gas Valves, Staging Valves, Level Sensors.		X			
Check system and motor-cooling liquid line to ensure sufficient sub-cooling.		X			
Verify discharge check valve operations. If there is backward gas flow immediately after stopping the compressor, replace the check valve.			X		
Inspect/clean motor-cooling strainer (if service has taken place).					X
Communications and Controls Inspection					
Verify communication between HMI, PLC, and BMS via BMS Interface page.		X			
Other Inspections					
Verify panel heater is set above 45°F and is in working condition.			X		
Verify optional heat trace is operating correctly and is set above 33°F.			X		

(a) During motor cooling strainer service or any other service, verify that there is no oil contaminating the refrigeration system.

(b) This verification should be performed by a competent company using nondestructive equipment. If chiller is under factory warranty, reports should be emailed to arctic.warranties@tranetechnologies.com.

(c) Fault and event logs should be emailed to arctic.warranties@tranetechnologies.com if the equipment is under warranty.

Winter Shutdown Preparation

Dry Layup Shutdown

Rooms where chillers have chance of freezing or coming in contact with hot water:

1. Close chilled water and condenser water isolation valves (if available).
2. Drain chilled water and condenser water barrels.
 - a. If valves were not available both loops will need to be drained completely.
3. Remove condenser and chilled water bell ends.
 - a. If chiller is single or three pass, one pipe end should be removed.
4. Using nitrogen or an air compressor blow out all tubes to ensure no water is left inside.

Wet layup Shutdown – Unheated Rooms

Rooms where chillers will have chance of freezing but not connected to the boiler loop:

1. Close chilled water and condenser water isolation valves (if available).
 - a. If valves are not available, they will need to be installed.
2. Drain chilled and condenser water barrels.
3. Completely fill the barrels with an appropriate amount of ethylene glycol solution for 15°F (8.3°C) below the expected low ambient condition.
4. Leave the barrels full of the solution until startup.
5. Mark the barrel stating what was left inside for precautions next season.

Wet layup Shutdown – Heated Rooms

Rooms that are heated and will not have contact with hot water:

1. Close chilled water and condenser water isolation valves (if available).
 - a. If valves are not available, they will need to be installed.
2. Talk to local chemical treatment company for correct chemical treatment for water left in barrel over winter.
 - a. If treatment needs to be changed, make proper arrangements.

Maintenance Tasks

The maintenance tasks described herein present the basic, minimal, steps required to successfully complete a task. Local policies and protocols may require more elaborate procedures with additional checks and inspections.

Critical Cleaning Tasks

Flooded Shell and Tube Heat Exchanger Cleaning Tasks:

NOTICE

Proper Water Treatment Required!

The use of untreated or improperly treated water could result in scaling, erosion, corrosion, algae or slime.

Use the services of a qualified water treatment specialist to determine what water treatment, if any, is required. Trane assumes no responsibility for equipment failures which result from untreated or improperly treated water, or saline or brackish water.

Condenser tube fouling is suspect when the approach temperature (i.e., the difference between the refrigerant condensing temperature and the leaving condenser water temperature) is higher than predicted. Standard water applications will operate with less than a 9°F approach. If the approach exceeds 9°F and there is noncondensable in the system, cleaning the condenser tubes is recommended.

***Note:** Glycol in the water system typically doubles the standard approach. If the annual condenser tube inspection indicates that the tubes are fouled, 2 cleaning methods can be used to rid the tubes of contaminants.*

Mechanical Cleaning Procedure

This method is used to remove sludge and loose material from smooth-bore evaporator/condenser tubes.

1. Remove the retaining bolts from the water boxes (if equipped) at each end of the evaporator and condenser. Use a hoist to lift the water boxes.
2. Work a round nylon or brass bristled brush (attached to a rod) in and out of each of the water tubes to loosen the sludge.
3. Thoroughly flush the evaporator/condenser water tubes with clean water (To clean internally enhanced tubes, use a bi-directional brush or consult a qualified service organization for recommendations).

Chemical Cleaning Procedure

Scale deposits are best removed by chemical means. Consult a qualified water treatment specialist (one that knows the local water supply chemical/mineral content) for a recommended cleaning solution suitable for the job. (A standard condenser water circuit is composed solely of copper, cast iron and steel.)

Improper chemical cleaning can damage tube walls. All of the materials used in the external circulation system, the quantity of the solution, the duration of the cleaning period, and any required safety precautions should be approved by the company furnishing the materials or performing the cleaning.



Maintenance Procedures

Note: Chemical tube cleaning should always be followed by mechanical tube cleaning.

Compressor Tasks

Compressor Removal

⚠ WARNING

Hazardous Voltage!

Failure to disconnect power before servicing could result in death or serious injury.

Disconnect all electric power, including remote disconnects before servicing. Follow proper lockout/tagout procedures to ensure the power can not be inadvertently energized. Verify that no power is present with a voltmeter.

1. Isolate the compressor power.
2. Remove the Mains Input Cover.
3. Remove the AC mains cables from the compressor terminals. Protect/Isolate cable ends.
4. Remove the Mains Input ground wire from the ground post.
5. Remove the cable gland that secures the Mains Input cable conduit to the Mains Input bracket.
6. Remove the Service Side Cover.
Important: Ensure that there is no secondary power source connected to the compressor before disconnecting the I/O cable.
7. Disconnect the I/O cable from the Backplane I/O connector (J7) and remove the cable from the compressor.
8. Reinstall the Service Side Cover.
9. Once the transfer of refrigerant is complete, bring the compressor back to atmospheric pressure according to industry standards using dry nitrogen.
10. Disconnect the compressor from the refrigerant system connections (suction, discharge, economizer and motor cooling line), taking care when removing connections that there is no residual pressure.
11. Reinstall the Mains Input Cover.
12. Remove the four compressor mounting bolts and associated hardware.
13. Connect an appropriate lifting device to the eyebolts provided on each side of the compressor and remove compressor.
14. Using the blanking plates and bolts provided with the new compressor, seal the compressor and charge to 25 psi with inert gas for shipment (this will prevent moisture and foreign material from entering the compressor).

Compressor Installation

⚠ WARNING

Hazardous Voltage!

Failure to disconnect power before servicing could result in death or serious injury.

Disconnect all electric power, including remote disconnects before servicing. Follow proper lockout/tagout procedures to ensure the power can not be inadvertently energized. Verify that no power is present with a voltmeter.

Note: Blanking plates should not be removed from the new compressor until you are ready to place the new compressor in position. New compressors are pressurized with inert gas to 50 psi. Pressure should be relieved through the Schrader valve, located next to the motor cooling connection, prior to removing the blanking plates.

1. Inspect the compressor to ensure all connections and fasteners are correctly installed.
2. Relieve the inert gas pressure through the motor cooling Schrader valve.
3. Remove the suction, discharge and economizer (if applicable) blanking plates from the new compressor.
4. Remove the motor cooling inlet adapter cap.
5. Mount the compressor in position and install the rubber mounts and hardware.
6. Attach all refrigerant line connections to the compressor using the new O-rings supplied with the compressor.
7. Tighten the economizer flange bolts (if applicable).
8. Tighten the discharge flange bolts.
9. Tighten the motor cooling line connection.
10. Tighten the suction flange bolts.
11. Remove the Service Side Cover.
12. Connect the compressor I/O cable to the Backplane.
13. Remove the Mains Input Cover.
14. Connect the cable gland that secures the Mains Input cable conduit to the Mains Input bracket.
15. Install the Mains Input ground wire to the ground post.
16. Attach the AC mains cables to the terminals.
17. Re-install the Mains Input Cover.
18. Leak test the compressor to appropriate pressure and industry accepted standards.
19. Evacuate compressor to appropriate pressure and industry accepted standards.
20. Charge the compressor with refrigerant.
21. Apply power to the compressor.



Chiller Troubleshooting

Chiller in Alarm Avoidance

The Chiller Management System continuously monitors for abnormal system conditions such as low suction pressure, high discharge pressure, low leaving temperature, high amp draw and others.

The controller implements a five-stage alarm management strategy in order to stay online as long as possible. The alarm management routine operates as follows:

Table 27. Alarm state descriptions

Alarm State		Action Taken By Compressor	Action Taken By Controller
Severity	Normal	No Action Required.	No Action Required.
	Compressor Alarm	Compressor self regulates and reports "At Maximum".	No Action Required. HMI annunciates alarm and logs.
	Compressor Fault	Compressor marked "Fault" and shuts down for reset. Most faults reset automatically, and the compressor is return to the "Idle" pool. Only affects the faulted compressor, chiller can still operate	Chiller controller tries to compensate for the missing compressor with PI-Loop and staging up if other compressors available. Compressor Fault is annunciates and logged in the HMI.
	Controller Warning (within 5% of controller Fault)	No Action Required except to react to demand of controller.	Controller reduces demand to alleviate warning condition. HMI annunciates alarm and logs.
	Controller Fault	No Action Required except to react to command from controller.	Controller enters Shutdown send 0% demand to all compressors. HMI annunciates fault and logs. Most controller faults are reset automatically and when reset complete chiller and compressor return to "Idle".

Alarms

All the alarms can be grouped into two main categories:

1. Chiller alarms
2. Compressor alarms

Chiller alarms group comprises chiller control system alarms, for instance sensors faults or equipment communication faults and chiller control devices alarms (other than compressors), for instance flow switches, pumps, condenser fans etc.

Compressor alarms can be non-critical or critical (fault). Compressor non-critical alarm does not usually affect compressor operation but serves as a warning that compressor operates in nearly fault conditions. Compressor faults, however, always stop compressor from operation and require fault condition to clear before compressor can restart.

Some of the compressor faults are lockout faults. They require a hard reset – power cycle – before compressor can restart.

Compressor Faults

If the fault is resettable such as a suction pressure, bearing displacement or motor over temperature fault, compressor stops and its state changes to **Fault**. The chiller controller attempts to automatically reset the fault and make the compressor available again. When compressor comes back to available its state changes to **Idle**.

If the fault cannot be reset automatically, the chiller controller places that compressor in the **Offline** state. The compressor requires a power cycle to clear and reset the fault. After clearing, the compressor returns to **Idle** state.

A maximum of three compressor faults per hour are tolerated. If more than three faults in an hour are generated the compressor is placed in **Offline** state, the compressor is considered locked out and requires a power-cycle.

If compressor trips out on a fault while the chiller is running and then recovers to **Idle**, controller selects it as the last compressor to start-up when the load increases.

Freeze Protection

The chiller system monitors both Ambient and LCHWT for potential incidents of freezing. If either threshold is breached, the chiller is in Freeze Protection mode. The chiller must be powered on for this function to work.

In Freeze Protection mode, all pumps are enabled at the maximum speed and all fluid isolation valves are opened. If pumps or valves are not controlled by the chiller, the system can still be provided with an hardwired output and a BMS signal.

Optional Sequences, Power Failure, and Rapid Restart

If a chiller is equipped with Rapid Restart feature and the site has sufficient power backup to run the chiller, when power fails, the controller remembers which compressors were running when power failed and restarts them when

Chiller Troubleshooting

power is restored. This feature assumes a timely power restoration, otherwise, the chiller goes into normal start-up.

Table 28. Chiller/Compressor alarms/Faults listing

Code	Description	Enable	Reset	Period	Start-Up	Steady	Active in Off	Alarm Relay	Warning Realy	Circuit System	Compressor
A01	Main switch	1	-1	0	25	0	X		X	SYSTEM	INTERLOCK
A02	Refrigerant NOT selected: Select, Restart	1	0	60	0	0	X	X		SYSTEM	INTERLOCK
A03	Evaporator flow switch alarm	1	-1	60	60	5		X		SYSTEM	OFF
A04	Condenser flow switch alarm	0	-1	60	60	30		X		SYSTEM	OFF
A05	Communication compressors fault	1	-1	0	0	0		X		SYSTEM	INTERLOCK
A06	Compressor in surge	0	-1	0	0	0				SYSTEM	-
A07	Entering water evap probe alarm	1	-1	0	0	0	X	X		SYSTEM	-
A08	Leaving water evap probe alarm	1	-1	0	0	0	X	X		SYSTEM	OFF
A09	Liquid temperature alarm	1	-1	0	0	0	X	X		SYSTEM	-
A10	Entering water evap transmitter alarm	1	-1	0	0	0	X	X		SYSTEM	-
A11	Leaving water evap transmitter alarm	1	-1	0	0	0	X	X		SYSTEM	OFF
A12	General condenser pumps alarm	0	-1	0	0	0	X	X		SYSTEM	-
A13	Outside air probe alarm	1	-1	0	0	0	X	X		SYSTEM	-
A14	Suction pressure transmitter alarm	1	-1	0	0	0	X	X		SYSTEM	-
A15	Discharge pressure transmitter alarm	1	-1	0	0	0	X	X		SYSTEM	-
A18	General low pressure alarm	1	-1	0	0	0	X	X		SYSTEM	INTERLOCK
A20	General high pressure alarm	1	-1	0	0	0	X	X		SYSTEM	INTERLOCK
A22	Evaporator high flow rate alarm	0	5	60	5	5		X		SYSTEM	INTERLOCK
A23	General evaporator pumps alarm	1	-1	0	0	0	X	X		SYSTEM	-
A24	Evaporator pump 1 protection alarm	1	-1	0	0	0	X	X		SYSTEM	-
A25	Evaporator pump 2 protection alarm	1	-1	0	0	0	X	X		SYSTEM	-
A26	Evap pump 1 run hours exceeded	1	-1	0	10	0	X	X		SYSTEM	-
A27	Evap pump 2 run hours exceeded	1	-1	0	10	0	X	X		SYSTEM	-
A28	Evaporator pump 2 ON	1	-1	0	0	0		X		NO	-
A29	NOT USED - Manual control activated	0	0	0	0	0	X	X		SYSTEM	-
A30	Evaporator antifreeze alarm	1	-1	0	10	0	X	X		SYSTEM	-
A31	General low sat suction temp alarm	1	-1	0	100	0	X	X		SYSTEM	-

Table 28. Chiller/Compressor alarms/Faults listing (continued)

Code	Description	Enable	Reset	Period	Start-Up	Steady	Active in Off	Alarm Relay	Warning Realy	Circuit System	Compressor
A32	General high pressure alarm from AI	0	-1	0	100	0		X		SYSTEM	-
A33	Genarel high compression ratio alarm	1	-1	0	100	0	X	X		SYSTEM	-
A34	Prevention: low Temperature	1	-1	0	10	sa9	X		X	SYSTEM	-
A35	Prevention: low sat suction temp	1	-1	0	100	sa9	X		X	SYSTEM	-
A36	Prevention: high pressure from AI	1	-1	0	100	sa9	X		X	SYSTEM	-
A37	Prevention: high pressure ratio	1	-1	0	100	sa9	X		X	SYSTEM	-
A38	Liquid level sensor alarm	1	3	60	10	10	X	X		SYSTEM	INTERLOCK
A39	High Liquid Level 1	1	-1	0	10	70	X		X	SYSTEM	-
A40	Low Liquid Level 1	0	-1	0	10	30	X		X	SYSTEM	-
A41	High Liquid Level 2	1	-1	0	10	70	X		X	SYSTEM	-
A42	Low Liquid Level 2	0	-1	0	10	30	X		X	SYSTEM	-
A43	General condenser fan protection	1	-1	0	0	0		X		SYSTEM	-
A44	Condenser fan bank1 fault	1	-1	0	0	0		X		SYSTEM	-
A45	Condenser fan bank2 fault	1	-1	0	0	0		X		SYSTEM	-
A46	Condenser fan bank3 fault	1	-1	0	0	0		X		SYSTEM	-
A47	Condenser fan 4 protection alarm	1	-1	0	0	0		X		SYSTEM	-
A48	Condenser fan 5 protection alarm	1	-1	0	0	0		X		SYSTEM	-
A49	Condenser fan 6 protection alarm	1	-1	0	0	0		X		SYSTEM	-
A50	Condenser fan 7 protection alarm	1	-1	0	0	0		X		SYSTEM	-
A51	Condenser fan 8 protection alarm	1	-1	0	0	0		X		SYSTEM	-
A53	TC1 protection alarm	1	-1	0	0	20				SYSTEM	OFF
A54	TC2 protection alarm	1	-1	0	0	0				SYSTEM	-
A55	TC3 protection alarm	1	-1	0	0	0				SYSTEM	-
A56	TC4 protection alarm	1	-1	0	0	0				SYSTEM	-
A57	TC5 protection alarm	1	-1	0	0	0				SYSTEM	-
A58	TC6 protection alarm	1	-1	0	0	0				SYSTEM	-
A59	General DI alarm 7	1	-1	0	0	0				SYSTEM	-
A60	General DI alarm 8	1	-1	0	0	0				SYSTEM	-
A61	General DI alarm 9	1	-1	0	0	0				SYSTEM	-



Chiller Troubleshooting

Table 28. Chiller/Compressor alarms/Faults listing (continued)

Code	Description	Enable	Reset	Period	Start-Up	Steady	Active in Off	Alarm Relay	Warning Realy	Circuit System	Compressor
A62	General DI alarm 10	1	-1	0	0	0				SYSTEM	–
A63	General AI alarm 1	1	-1	0	0	0				SYSTEM	–
A64	General AI alarm 2	1	-1	0	0	0				SYSTEM	–
A65	General AI alarm 3	1	-1	0	0	0				SYSTEM	–
A66	General AI alarm 4	1	-1	0	0	0				SYSTEM	–
A67	General AI alarm 5	1	-1	0	0	0				SYSTEM	–
A68	General AI alarm 6	1	-1	0	0	0				SYSTEM	–
A69	General AI alarm 7	1	-1	0	0	0				SYSTEM	–
A70	General AI alarm 8	1	-1	0	0	0				SYSTEM	–
A71	General AI alarm 9	1	-1	0	0	0				SYSTEM	–
A72	General AI alarm 10	1	-1	0	0	0				SYSTEM	–
A73	Common interlock activated	0	-1	0	0	0				SYSTEM	–
A74	Compressor 1 interlock activated	1	-1	0	0	0			X	SYSTEM	–
A75	Compressor 2 interlock activated	1	-1	0	0	0			X	SYSTEM	–
A76	Compressor 3 interlock activated	1	-1	0	0	0			X	SYSTEM	–
A77	Compressor 4 interlock activated	1	-1	0	0	0			X	SYSTEM	–
A7a	Compressor 5 interlock activated	0	0	0	0	0				NO	–
A7b	Compressor 6 interlock activated	0	0	0	0	0				NO	–
A78	General heaters protection alarm	1	-1	0	0	0		X		SYSTEM	–
A79	Heat Trace alarm	1	-1	0	0	0		X		SYSTEM	–
A80	Heater 2 protection alarm	1	-1	0	0	0		X		SYSTEM	–
A81	Heater 3 protection alarm	1	-1	0	0	0		X		SYSTEM	–
A82	Heater 4 protection alarm	1	-1	0	0	0		X		SYSTEM	–
A83	Evap. Condenser water level	1	-1	0	0	0		X		SYSTEM	–
A84	Evap. Condenser heaters	1	-1	0	0	0		X		SYSTEM	–

Table 28. Chiller/Compressor alarms/Faults listing (continued)

Code	Description	Enable	Reset	Period	Start-Up	Steady	Active in Off	Alarm Relay	Warning Realy	Circuit System	Compressor
A85	Smart Cooler System Fault	1	-1	0	0	0		X		SYSTEM	–
A86	Cooling enable off	1	-1	0	0	0				SYSTEM	–
A87	Scheduled action	1	-1	0	0	0				SYSTEM	–
A88	Scheduler list cleared	1	-1	0	0	0				SYSTEM	–
A89	Parameters reset to default	1	-1	0	0	0				SYSTEM	–
A90	Capacity limited	1	-1	0	0	0			X	SYSTEM	–
A91	Phase loss alarm	1	0	0	0	0		X		SYSTEM	OFF
A96	Condenser pump 1 overload	1	0	0	0	0		X		SYSTEM	–
A97	Condenser pump 2 overload	1	0	0	0	0		X		SYSTEM	–
A98	Condenser pump 1 run hours exceeded	1	0	0	0	0		X		SYSTEM	–
A99	Condenser pump 2 run hours exceeded	1	0	0	0	0		X		SYSTEM	–
A9a	Condenser pump switched due to fault	1	0	0	0	0		X		SYSTEM	–
aux	Aux device communication error	1	-1	0	60	0		X		SYSTEM	–
Compressor #1											
aC1	TC1 communication error	1	-1	0	60	0		X		SYSTEM	–
a11	TC1 AC - Inverter Temperature	1	-1	0	0	0	X	X		SYSTEM	–
a12	TC1 AC - Discharge Temp	1	-1	0	0	0	X	X		SYSTEM	–
a13	TC1 AC - Suction Pressure	1	-1	0	0	0	X	X		SYSTEM	–
a14	TC1 AC - Discharge Pressure	1	-1	0	0	0	X	X		SYSTEM	–
a15	TC1 AC - 3 Phase Current Trip	1	-1	0	0	0	X	X		SYSTEM	–
a16	TC1 AC - Shaft Cavity Temperature	1	-1	0	0	0	X	X		SYSTEM	–
a17	TC1 AC - Leaving Air /Water	1	-1	0	0	0	X	X		SYSTEM	–
a18	TC1 AC - Total Compression Ratio Fault	1	-1	0	0	0	X	X		SYSTEM	–
a19	TC1 AC - Bearing Motor Fault	1	-1	0	0	0	X	X		SYSTEM	–
a1A	TC1 AC - Sensor error	1	-1	0	0	0	X	X		SYSTEM	–
a1B	TC1 AC - SCR Fault	1	-1	0	0	0	X	X		SYSTEM	–
a1C	TC1 AC - Lock out Fault	1	-1	0	0	0	X	X		SYSTEM	–
a1D	TC1 AC - Motor Thermistor	1	-1	0	0	0	X	X		SYSTEM	–
a1E	TC1 AC - Super Heat Fault	1	-1	0	0	0	X	X		SYSTEM	–
a1P	TC1 AC - Eart Leakage Fault	1	-1	0	0	0		X		SYSTEM	–



Chiller Troubleshooting

Table 28. Chiller/Compressor alarms/Faults listing (continued)

Code	Description	Enable	Reset	Period	Start-Up	Steady	Active in Off	Alarm Relay	Warning Realy	Circuit System	Compressor
a1Q	TC1 AC - Soft Start Fault	1	-1	0	0	0		X		SYSTEM	–
a1F	TC1 ANC - Inverter Temperature	1	-1	0	0	0	X		X	SYSTEM	–
a1G	TC1 ANC - Discharge Temp	1	-1	0	0	0	X		X	SYSTEM	–
a1H	TC1 ANC - Suction Pressure	1	-1	0	0	0			X	SYSTEM	–
a1I	TC1 ANC - Discharge Pressure	1	-1	0	0	0			X	SYSTEM	–
a1J	TC1 ANC - 3 Phase Current Trip	1	-1	0	0	0	X		X	SYSTEM	–
a1K	TC1 ANC - Shaft Cavity Temperature	1	-1	0	0	0	X		X	SYSTEM	–
a1L	TC1 ANC - Leaving Water	1	-1	0	0	0	X		X	SYSTEM	–
a1M	TC1 ANC - Total Compression Ratio Fault	1	-1	0	0	0	X		X	SYSTEM	–
a1N	TC1 ANC - SCR Temperature	1	-1	0	0	0			X	SYSTEM	–
a1O	TC1 ANC - Super Heat	1	-1	0	0	0	X		X	SYSTEM	–
a1X	TC1 ANC - EEPROM checksum error	1	-1	0	0	0			X	SYSTEM	–
a1Y	TC1 AC Generator mode	1	-1	0	0	0		X		NO	–
Compressor #2											
aC2	TC2 communication error	1	-1	0	60	0		X		SYSTEM	–
a21	TC2 AC - Inverter Temperature	1	-1	0	0	0	X	X		SYSTEM	–
a22	TC2 AC - Discharge Temp	1	-1	0	0	0	X	X		SYSTEM	–
a23	TC2 AC - Suction Pressure	1	-1	0	0	0	X	X		SYSTEM	–
a24	TC2 AC - Discharge Pressure	1	-1	0	0	0	X	X		SYSTEM	–
a25	TC2 AC - 3 Phase Current Trip	1	-1	0	0	0	X	X		SYSTEM	–
a26	TC2 AC - Shaft Cavity Temperature	1	-1	0	0	0	X	X		SYSTEM	–
a27	TC2 AC - Leaving Air /Water	1	-1	0	0	0	X	X		SYSTEM	–
a28	TC2 AC - Total Compression Ratio Fault	1	-1	0	0	0	X	X		SYSTEM	–
a29	TC2 AC - Bearing Motor Fault	1	-1	0	0	0	X	X		SYSTEM	–
a2A	TC2 AC - Sensor error	1	-1	0	0	0	X	X		SYSTEM	–
a2B	TC2 AC - SCR Fault	1	-1	0	0	0	X	X		SYSTEM	–
a2C	TC2 AC - Lock out Fault	1	-1	0	0	0	X	X		SYSTEM	–
a2D	TC2 AC - Motor Thermistor	1	-1	0	0	0	X	X		SYSTEM	–

Table 28. Chiller/Compressor alarms/Faults listing (continued)

Code	Description	Enable	Reset	Period	Start-Up	Steady	Active in Off	Alarm Relay	Warning Realy	Circuit System	Compressor
a2E	TC2 AC - Super Heat Fault	1	-1	0	0	0	X	X		SYSTEM	–
a2P	TC2 AC - Eart Leakage Fault	1	-1	0	0	0		X		SYSTEM	–
a2Q	TC2 AC - Soft Start Fault	1	-1	0	0	0		X		SYSTEM	–
a2F	TC2 ANC - Inverter Temperature	1	-1	0	0	0	X		X	SYSTEM	–
a2G	TC2 ANC - Discharge Temp	1	-1	0	0	0	X		X	SYSTEM	–
a2H	TC2 ANC - Suction Pressure	1	-1	0	0	0			X	SYSTEM	–
a2I	TC2 ANC - Discharge Pressure	1	-1	0	0	0			X	SYSTEM	–
a2J	TC2 ANC - 3 Phase Current Trip	1	-1	0	0	0	X		X	SYSTEM	–
a2K	TC2 ANC - Shaft Cavity Temperature	1	-1	0	0	0	X		X	SYSTEM	–
a2L	TC2 ANC - Leaving Water	1	-1	0	0	0	X		X	SYSTEM	–
a2M	TC2 ANC - Total Compression Ratio Fault	1	-1	0	0	0	X		X	SYSTEM	–
a2N	TC2 ANC - SCR Temperature	1	-1	0	0	0	X		X	SYSTEM	–
a2O	TC2 ANC - Super Heat	1	-1	0	0	0	X		X	SYSTEM	–
a2X	TC2 ANC - EEPROM checksum error	1	-1	0	0	0			X	SYSTEM	–
a2Y	TC2 AC Generator mode	1	-1	0	0	0		X		NO	–
Compressor #3											
aC3	TC3 communication error	1	-1	0	0	0		X		SYSTEM	–
a31	TC3 AC - Inverter Temperature	1	-1	0	0	0	X	X		SYSTEM	–
a32	TC3 AC - Discharge Temp	1	-1	0	0	0	X	X		SYSTEM	–
a33	TC3 AC - Suction Pressure	1	-1	0	0	0	X	X		SYSTEM	–
a34	TC3 AC - Discharge Pressure	1	-1	0	0	0	X	X		SYSTEM	–
a35	TC3 AC - 3 Phase Current Trip	1	-1	0	0	0	X	X		SYSTEM	–
a36	TC3 AC - Shaft Cavity Temperature	1	-1	0	0	0	X	X		SYSTEM	–
a37	TC3 AC - Leaving Air /Water	1	-1	0	0	0	X	X		SYSTEM	–
a38	TC3 AC - Total Compression Ratio Fault	1	-1	0	0	0	X	X		SYSTEM	–
a39	TC3 AC - Bearing Motor Fault	1	-1	0	0	0	X	X		SYSTEM	–
a3A	TC3 AC - Sensor error	1	-1	0	0	0	X	X		SYSTEM	–
a3B	TC3 AC - SCR Fault	1	-1	0	0	0	X	X		SYSTEM	–



Chiller Troubleshooting

Table 28. Chiller/Compressor alarms/Faults listing (continued)

Code	Description	Enable	Reset	Period	Start-Up	Steady	Active in Off	Alarm Relay	Warning Realy	Circuit System	Compressor
a3C	TC3 AC - Lock out Fault	1	-1	0	0	0	X	X		SYSTEM	–
a3D	TC3 AC - Motor Thermistor	1	-1	0	0	0	X	X		SYSTEM	–
a3E	TC3 ANC - Super Heat	1	-1	0	0	0	X	X		SYSTEM	–
a3P	TC3 AC - Eart Leakage Fault	1	-1	0	0	0		X		SYSTEM	–
a3Q	TC3 AC - Soft Start Fault	1	-1	0	0	0		X		SYSTEM	–
a3F	TC3 ANC - Inverter Temperature	1	-1	0	0	0	X		X	SYSTEM	–
a3G	TC3 ANC - Discharge Temp	1	-1	0	0	0	X		X	SYSTEM	–
a3H	TC3 ANC - Suction Pressure	1	-1	0	0	0			X	SYSTEM	–
a3I	TC3 ANC - Discharge Pressure	1	-1	0	0	0			X	SYSTEM	–
a3J	TC3 ANC - 3 Phase Current Trip	1	-1	0	0	0	X		X	SYSTEM	–
a3K	TC3 ANC - Shaft Cavity Temperature	1	-1	0	0	0	X		X	SYSTEM	–
a3L	TC3 ANC - Leaving Water	1	-1	0	0	0	X		X	SYSTEM	–
a3M	TC3 ANC - Total Compression Ratio Fault	1	-1	0	0	0	X		X	SYSTEM	–
a3N	TC3 ANC - SCR Temperature	1	-1	0	0	0	X		X	SYSTEM	–
a3O	TC3 ANC - Super Heat	1	-1	0	0	0	X		X	SYSTEM	–
a3X	TC3 ANC - EEPROM checksum error	1	-1	0	0	0			X	SYSTEM	–
a3Y	TC3 AC Generator mode	1	-1	0	0	0		X		NO	–
Compressor #4											
aC4	TC4 communication error	1	-1	0	0	0		X		SYSTEM	–
a41	TC4 AC - Inverter Temperature	1	-1	0	0	0	X	X		SYSTEM	–
a42	TC4 AC - Discharge Temp	1	-1	0	0	0	X	X		SYSTEM	–
a43	TC4 AC - Suction Pressure	1	-1	0	0	0	X	X		SYSTEM	–
a44	TC4 AC - Discharge Pressure	1	-1	0	0	0	X	X		SYSTEM	–
a45	TC4 AC - 3 Phase Current Trip	1	-1	0	0	0	X	X		SYSTEM	–
a46	TC4 AC - Shaft Cavity Temperature	1	-1	0	0	0	X	X		SYSTEM	–
a47	TC4 AC - Leaving Air /Water	1	-1	0	0	0	X	X		SYSTEM	–
a48	TC4 AC - Total Compression Ratio Fault	1	-1	0	0	0	X	X		SYSTEM	–

Table 28. Chiller/Compressor alarms/Faults listing (continued)

Code	Description	Enable	Reset	Period	Start-Up	Steady	Active in Off	Alarm Relay	Warning Realy	Circuit System	Compressor
a49	TC4 AC - Bearing Motor Fault	1	-1	0	0	0	X	X		SYSTEM	–
a4A	TC4 AC - Sensor error	1	-1	0	0	0	X	X		SYSTEM	–
a4B	TC4 AC - SCR Fault	1	-1	0	0	0	X	X		SYSTEM	–
a4C	TC4 AC - Lock out Fault	1	-1	0	0	0	X	X		SYSTEM	–
a4D	TC4 AC - Motor Thermistor	1	-1	0	0	0	X	X		SYSTEM	–
a4E	TC4 ANC - Super Heat	1	-1	0	0	0	X	X		SYSTEM	–
a4P	TC4 AC - Eart Leakage Fault	1	-1	0	0	0		X		SYSTEM	–
a4Q	TC4 AC - Soft Start Fault	1	-1	0	0	0		X		SYSTEM	–
a4F	TC4 ANC - Inverter Temperature	1	-1	0	0	0	X		X	SYSTEM	–
a4G	TC4 ANC - Discharge Temp	1	-1	0	0	0	X		X	SYSTEM	–
a4H	TC4 ANC - Suction Pressure	1	-1	0	0	0			X	SYSTEM	–
a4I	TC4 ANC - Discharge Pressure	1	-1	0	0	0			X	SYSTEM	–
a4J	TC4 ANC - 3 Phase Current Trip	1	-1	0	0	0	X		X	SYSTEM	–
a4K	TC4 ANC - Shaft Cavity Temperature	1	-1	0	0	0	X		X	SYSTEM	–
a4L	TC4 ANC - Leaving Water	1	-1	0	0	0	X		X	SYSTEM	–
a4M	TC4 ANC - Total Compression Ratio Fault	1	-1	0	0	0	X		X	SYSTEM	–
a4N	TC4 ANC - SCR Temperature	1	-1	0	0	0	X		X	SYSTEM	–
a4O	TC4 ANC - Super Heat	1	-1	0	0	0	X		X	SYSTEM	–
a4X	TC4 ANC - EEPROM checksum error	1	-1	0	0	0			X	SYSTEM	–
a4Y	TC4 AC Generator mode	1	-1	0	0	0	X	X		NO	–
Compressor #5											
aC5	TC5 communication error	1	-1	0	0	0		X		SYSTEM	–
a51	TC5 AC - Inverter Temperature	1	-1	0	0	0		X		SYSTEM	–
a52	TC5 AC - Discharge Temp	1	-1	0	0	0		X		SYSTEM	–
a53	TC5 AC - Suction Pressure	1	-1	0	0	0		X		SYSTEM	–
a54	TC5 AC - Discharge Pressure	1	-1	0	0	0		X		SYSTEM	–
a55	TC5 AC - 3 Phase Current Trip	1	-1	0	0	0		X		SYSTEM	–



Chiller Troubleshooting

Table 28. Chiller/Compressor alarms/Faults listing (continued)

Code	Description	Enable	Reset	Period	Start-Up	Steady	Active in Off	Alarm Relay	Warning Realy	Circuit System	Compressor
a56	TC5 AC - Shaft Cavity Temperature	1	-1	0	0	0		X		SYSTEM	-
a57	TC5 AC - Leaving Air /Water	1	-1	0	0	0		X		SYSTEM	-
a58	TC5 AC - Total Compression Ratio Fault	1	-1	0	0	0		X		SYSTEM	-
a59	TC5 AC - Bearing Motor Fault	1	-1	0	0	0		X		SYSTEM	-
a5A	TC5 AC - Sensor error	1	-1	0	0	0		X		SYSTEM	-
a5B	TC5 AC - SCR Fault	1	-1	0	0	0		X		SYSTEM	-
a5C	TC5 AC - Lock out Fault	1	-1	0	0	0		X		SYSTEM	-
a5D	TC5 AC - Motor Thermistor	1	-1	0	0	0		X		SYSTEM	-
a5E	TC5 ANC - Super Heat	1	-1	0	0	0		X		SYSTEM	-
a5P	TC5 AC - Eart Leakage Fault	1	-1	0	0	0		X		SYSTEM	-
a5Q	TC5 AC - Soft Start Fault	1	-1	0	0	0		X		SYSTEM	-
a5F	TC5 ANC - Inverter Temperature	1	-1	0	0	0			X	SYSTEM	-
a5G	TC5 ANC - Discharge Temp	1	-1	0	0	0			X	SYSTEM	-
a5H	TC5 ANC - Suction Pressure	1	-1	0	0	0			X	SYSTEM	-
a5I	TC5 ANC - Discharge Pressure	1	-1	0	0	0			X	SYSTEM	-
a5J	TC5 ANC - 3 Phase Current Trip	1	-1	0	0	0			X	SYSTEM	-
a5K	TC5 ANC - Shaft Cavity Temperature	1	-1	0	0	0			X	SYSTEM	-
a5L	TC5 ANC - Leaving Water	1	-1	0	0	0			X	SYSTEM	-
a5M	TC5 ANC - Total Compression Ratio Fault	1	-1	0	0	0			X	SYSTEM	-
a5N	TC5 ANC - SCR Temperature	1	-1	0	0	0			X	SYSTEM	-
a5O	TC5 ANC - Super Heat	1	-1	0	0	0			X	SYSTEM	-
a5X	TC5 ANC - EEPROM checksum error	1	-1	0	0	0			X	SYSTEM	-
a5Y	TC5 AC Generator mode	1	-1	0	0	0		X		NO	-
Compressor #6											
aC6	TC6 communication error	1	-1	0	0	0	X	X		SYSTEM	-
a61	TC6 AC - Inverter Temperature	1	-1	0	0	0		X		SYSTEM	-
a62	TC6 AC - Discharge Temp	1	-1	0	0	0		X		SYSTEM	-
a63	TC6 AC - Suction Pressure	1	-1	0	0	0		X		SYSTEM	-

Table 28. Chiller/Compressor alarms/Faults listing (continued)

Code	Description	Enable	Reset	Period	Start-Up	Steady	Active in Off	Alarm Relay	Warning Realy	Circuit System	Compressor
a64	TC6 AC - Discharge Pressure	1	-1	0	0	0		X		SYSTEM	-
a65	TC6 AC - 3 Phase Current Trip	1	-1	0	0	0		X		SYSTEM	-
a66	TC6 AC - Shaft Cavity Temperature	1	-1	0	0	0		X		SYSTEM	-
a67	TC6 AC - Leaving Air /Water	1	-1	0	0	0		X		SYSTEM	-
a68	TC6 AC - Total Compression Ratio Fault	1	-1	0	0	0		X		SYSTEM	-
a69	TC6 AC - Bearing Motor Fault	1	-1	0	0	0		X		SYSTEM	-
a6A	TC6 AC - Sensor error	1	-1	0	0	0		X		SYSTEM	-
a6B	TC6 AC - SCR Fault	1	-1	0	0	0		X		SYSTEM	-
a6C	TC6 AC - Lock out Fault	1	-1	0	0	0		X		SYSTEM	-
a6D	TC6 AC - Motor Thermistor	1	-1	0	0	0		X		SYSTEM	-
a6E	TC6 ANC - Super Heat	1	-1	0	0	0		X		SYSTEM	-
a6P	TC6 AC - Eart Leakage Fault	1	-1	0	0	0		X		SYSTEM	-
a6Q	TC6 AC - Soft Start Fault	1	-1	0	0	0		X		SYSTEM	-
a6F	TC6 ANC - Inverter Temperature	1	-1	0	0	0			X	SYSTEM	-
a6G	TC6 ANC - Discharge Temp	1	-1	0	0	0			X	SYSTEM	-
a6H	TC6 ANC - Suction Pressure	1	-1	0	0	0			X	SYSTEM	-
a6I	TC6 ANC - Discharge Pressure	1	-1	0	0	0			X	SYSTEM	-
a6J	TC6 ANC - 3 Phase Current Trip	1	-1	0	0	0			X	SYSTEM	-
a6K	TC6 ANC - Shaft Cavity Temperature	1	-1	0	0	0			X	SYSTEM	-
a6L	TC6 ANC - Leaving Water	1	-1	0	0	0			X	SYSTEM	-
a6M	TC6 ANC - Total Compression Ratio Fault	1	-1	0	0	0			X	SYSTEM	-
a6N	TC6 ANC - SCR Temperature	1	-1	0	0	0			X	SYSTEM	-
a6O	TC6 ANC - Super Heat	1	-1	0	0	0			X	SYSTEM	-
a6X	TC6 ANC - EEPROM checksum error	1	-1	0	0	0			X	SYSTEM	-
a6Y	TC6 AC Generator mode	1	-1	0	0	0	X	X		NO	-
A92	Evaporator low flow rate alarm	0	5	60	45	5		X		SYSTEM	INTERLOCK
A93	Condenser high flow rate alarm	0	5	60	5	5		X		SYSTEM	-
A94	Condenser low flow rate alarm	0	5	60	5	5		X		SYSTEM	-
A95	Master connection lost	1	-1	0	15	0		X		SYSTEM	-

Chiller Troubleshooting

Table 28. Chiller/Compressor alarms/Faults listing (continued)

Code	Description	Enable	Reset	Period	Start-Up	Steady	Active in Off	Alarm Relay	Warning Realy	Circuit System	Compressor
N01	Network Error	1	-1	90	60	60		X		SYSTEM	–
N02	Master Error	1	-1	90	60	60			X	SYSTEM	–
N03	Alarm Node 1	1	-1	90	60	0	X		X	SYSTEM	–
N04	Alarm Node 2	1	-1	90	60	0	X		X	SYSTEM	–
N05	Alarm Node 3	1	-1	90	60	0	X		X	SYSTEM	–
N06	Alarm Node 4	1	-1	90	60	0	X		X	SYSTEM	–
Cn	Expansion communication fault	1	0	0	5	5	X	X		SYSTEM	INTERLOCK
Ovr	IO override	1	-1	10	0	0			X	NO	–
AA0	Internal Compressor 1 Interlock	0	0	10	0	0				NO	–
AA1	Internal Compressor 2 Interlock	0	0	10	0	0				NO	–
AA2	Internal Compressor 3 Interlock	0	0	10	0	0				NO	–
AA3	Internal Compressor 4 Interlock	0	0	10	0	0				NO	–
AA4	Internal Compressor 5 Interlock	0	0	10	0	0				NO	–
AA5	Internal Compressor 6 Interlock	0	0	10	0	0			X	NO	–
AAC	Cut off: low Temperature	1	-1	0	0	0			X	SYSTEM	INTERLOCK
AAD	UPS power supply	1	-1	0	10	0	X	X		NO	–
AAE	Fast Restart Detect	1	-1	0	0	0				NO	–
AAF	Phase loss alarm detect	1	-1	0	0	0		X		NO	–
AAG	Priority alarm setting	1	-1	0	0	0	X	X		SYSTEM	INTERLOCK

Note: For a complete list of compressor, motor and bearing faults: [https://files.danfoss.com/download/Drives/Service%20Manual%20\(M-SV-001-EN%20Rev.%20E\).pdf](https://files.danfoss.com/download/Drives/Service%20Manual%20(M-SV-001-EN%20Rev.%20E).pdf)

Trane - by Trane Technologies (NYSE: TT), a global innovator - creates comfortable, energy efficient indoor environments for commercial and residential applications. For more information, please visit trane.com or tranetechnologies.com.

Trane has a policy of continuous product and product data improvements and reserves the right to change design and specifications without notice. We are committed to using environmentally conscious print practices.

ARTC-SVX014A-EN 10 Feb 2024
Supersedes (New)

©2024 Trane