



Installation, Operation, and Maintenance

SuperMod™ Water-Cooled Modular Chiller



SAFETY WARNING

Only qualified personnel should install and service the equipment. The installation, starting up, and servicing of heating, ventilating, and air-conditioning equipment can be hazardous and requires specific knowledge and training. Improperly installed, adjusted or altered equipment by an unqualified person could result in death or serious injury. When working on the equipment, observe all precautions in the literature and on the tags, stickers, and labels that are attached to the equipment.



Introduction

Read this manual thoroughly before operating or servicing this unit.

Warnings, Cautions, and Notices

Safety advisories appear throughout this manual as required. Your personal safety and the proper operation of this machine depend upon the strict observance of these precautions.

The three types of advisories are defined as follows:



Indicates a potentially hazardous situation which, if not avoided, could result in death or serious injury.



Indicates a potentially hazardous situation which, if not avoided, could result in minor or moderate injury. It could also be used to alert against unsafe practices.



Indicates a situation that could result in equipment or property-damage only accidents.

Important Environmental Concerns

Scientific research has shown that certain man-made chemicals can affect the earth's naturally occurring stratospheric ozone layer when released to the atmosphere. In particular, several of the identified chemicals that may affect the ozone layer are refrigerants that contain Chlorine, Fluorine and Carbon (CFCs) and those containing Hydrogen, Chlorine, Fluorine and Carbon (HCFCs). Not all refrigerants containing these compounds have the same potential impact to the environment. Trane advocates the responsible handling of all refrigerants-including industry replacements for CFCs and HCFCs such as saturated or unsaturated HFCs and HCFCs.

Important Responsible Refrigerant Practices

Trane believes that responsible refrigerant practices are important to the environment, our customers, and the air conditioning industry. All technicians who handle refrigerants must be certified according to local rules. For the USA, the Federal Clean Air Act (Section 608) sets forth the requirements for handling, reclaiming, recovering and recycling of certain refrigerants and the equipment that is used in these service procedures. In addition, some states or municipalities may have additional requirements that must also be adhered to for responsible management of refrigerants. Know the applicable laws and follow them.

⚠ WARNING

Proper Field Wiring and Grounding Required!

Failure to follow code could result in death or serious injury.

All field wiring **MUST** be performed by qualified personnel. Improperly installed and grounded field wiring poses **FIRE** and **ELECTROCUTION** hazards. To avoid these hazards, you **MUST** follow requirements for field wiring installation and grounding as described in NEC and your local/state/national electrical codes.

⚠ WARNING

Personal Protective Equipment (PPE) Required!

Failure to wear proper PPE for the job being undertaken could result in death or serious injury. Technicians, in order to protect themselves from potential electrical, mechanical, and chemical hazards, **MUST** follow precautions in this manual and on the tags, stickers, and labels, as well as the instructions below:

- Before installing/servicing this unit, technicians **MUST** put on all PPE required for the work being undertaken (Examples; cut resistant gloves/sleeves, butyl gloves, safety glasses, hard hat/bump cap, fall protection, electrical PPE and arc flash clothing). **ALWAYS** refer to appropriate Safety Data Sheets (SDS) and OSHA guidelines for proper PPE.
- When working with or around hazardous chemicals, **ALWAYS** refer to the appropriate SDS and OSHA/GHS (Global Harmonized System of Classification and Labelling of Chemicals) guidelines for information on allowable personal exposure levels, proper respiratory protection and handling instructions.
- If there is a risk of energized electrical contact, arc, or flash, technicians **MUST** put on all PPE in accordance with OSHA, NFPA 70E, or other country-specific requirements for arc flash protection, **PRIOR** to servicing the unit. **NEVER PERFORM ANY SWITCHING, DISCONNECTING, OR VOLTAGE TESTING WITHOUT PROPER ELECTRICAL PPE AND ARC FLASH CLOTHING. ENSURE ELECTRICAL METERS AND EQUIPMENT ARE PROPERLY RATED FOR INTENDED VOLTAGE.**

⚠ WARNING**Follow EHS Policies!**

Failure to follow instructions below could result in death or serious injury.

- All Trane personnel must follow the company's Environmental, Health and Safety (EHS) policies when performing work such as hot work, electrical, fall protection, lockout/tagout, refrigerant handling, etc. Where local regulations are more stringent than these policies, those regulations supersede these policies.
- Non-Trane personnel should always follow local regulations.

Copyright

This document and the information in it are the property of Trane, and may not be used or reproduced in whole or in part without written permission. Trane reserves the right to revise this publication at any time, and to make changes to its content without obligation to notify any person of such revision or change.

Trademarks

All trademarks referenced in this document are the trademarks of their respective owners.

Revision History

- Updated controller terminology and branding.
- Minor updates to document.



Table of Contents

Model Number Descriptions.....	6	Power Interlock Switch	20
Model Number and Coding.....	7	Module Control Wiring	20
Chiller Model and Serial Numbers	7	Operating Principles	21
Model Number	7	Operating Procedures	22
Model Coding Key	7	Operator Interface	22
Chiller Description.....	8	Chiller Power Panels	22
Chiller Scope	8	Panel-Mounted Disconnect	
Chiller Capacities	8	Switch	22
Component Description	8	Power Distribution Panels	22
Pre-Installation	11	Module Electrical and Control	
Preparation for Initial Startup	11	Panel	23
Initial Startup	11	Electronic Control	23
Installation Mechanical	14	Controllers	23
Inspect and Report Damage	14	Operating the Microprocessor	24
Inspection of Delivered		Microprocessor Functions	24
Equipment	14	Password Protection	24
Warranty Issues.....	14	Operator Control.....	24
Long Term Storage Requirements	14	Touchscreen Interface Panel	25
Factory Preparation	14	Touchscreen Interface Tutorial.....	25
Customer Responsibilities	15	Interface Menu Structure	25
Handling of the Modules	15	Home Screen Features	26
Site Preparation and Clearances	15	HMI Functions	26
Chiller Clearances.....	15	Modules Layout Screen	28
Minimum Clearances.....	16	Module Layout Screen Status	
Service Access.....	16	Conditions	28
Rigging, Lifting, and Moving the		Active Alarms Screen	29
Chiller	16	Alarm History.....	30
Mounting Rails	17	Modules Overview Screens	30
Installation Piping	18	Overview Module	31
Install Piping and External		Overview Circuits	32
Components	18	Module I/O Screens	32
Initial Flushing of Piping.....	18	Analog Inputs.....	33
Fill with Water/Glycol Solution	18	Analog Outputs.....	33
Connecting Module Couplings	18	Digital Inputs	34
Digital Outputs.....	34		
Installation Electrical	20	Trend Screen	34
Connecting Module Power and Control		Operator Tasks	35
Wires	20	Normal Power Up.....	35
Chiller Module Main Power	20	Emergency Power Shutdown.....	36
Phase Monitor Installation	20	Water Quality Guidelines.....	36
		Monitor Water Quality	37
		Maintain Glycol Level	37
		Prevent Freezing	38

Controls Interface	40	Pump Tasks	52
Microprocessor Control System	40	Controller Tasks	54
Primary Microprocessor		Chiller Troubleshooting	55
Controller	40	General Approach to Fault Isolation	55
Secondary Microprocessor		Controller Diagnostic Codes	55
Controller	40	Compressor Diagnostic Codes	56
Touchscreen Interface Panel	40	CoreSense Flash Codes	56
Operator Control and		CoreSense Flash Code	
Monitoring	40	Description	56
Chiller Control	40	Phase Monitor Protection	58
Power Distribution	40	Symptoms and Solutions	58
Electrical Controls	41	Variable Frequency Drive	
Refrigeration Controls	42	Diagnostics	62
Sequence of Operations	43	Status Modes	62
Variable Flow Sequence	43	Alarm Indications	63
Chiller Performance Data	45	Trip Indications	64
Maintenance Procedures	46	Logical Flow Diagrams	71
Maintenance Strategy	46	High Voltage Logical Flow	71
Power Disconnect Switch	46	Control Logical Flow	72
Federal Clean Air Act	47	Refrigeration Logical Flow	73
Inspection and Maintenance		Water/Glycol Mixture Logical Flow	74
Schedule	47	Acronyms and Abbreviations	A-1
Daily	47	Acronym List	A-1
Weekly	48	Request for Initial Startup	B-1
Monthly	48	SuperMod™ Water-Cooled Modular	
Quarterly	49	Chiller	B-1
Annually	49	Initial Startup Agreement	B-2
Maintenance Tasks	50		
Inspection Methods	50		
Critical Cleaning Tasks	50		
Compressor Tasks	51		



Model Number Descriptions

Digit 1 – Brand

T = Trane

Digit 2 – Model Series

P = Process and Modular Series

Digit 3, 4, 5 – Condenser Type

ACH = Air-Cooled, Horizontal Air Flow

ACV = Air-Cooled, Vertical Air Flow

ACR = Air-Cooled Remote Condenser

WCC = Water-Cooled Condenser

Digit 6 – Chilled Water System

P = Recirculating System, Tank and Pump

M = Single Pass Chiller Unit, no Tank and Pump

Digit 7 – Cabinet Type

H = Horizontal Low Profile

V = Vertical Upright

Digit 8, 9, 10, 11 – Chiller Capacity

0030 = 3 Ton Capacity

0300 = 30 Ton Capacity

Digit 12 – Refrigeration Circuits

D = Dual Independent Refrigeration Circuits

S = Single Refrigeration Circuit

R = Redundant Refrigeration

T = Tandem Compressors Set in Single Circuit

Digit 13 – Voltage

1 = 208/230/60/1

2 = 460/60/1

3 = 208/230/60/3

4 = 460/60/3

5 = 575/60/3

7 = 380/50/3

Digit 14 – Chiller Application

MM = Modular

Digit 15, 16 – Additional Features

VS = Variable Speed

VS1 = Variable Speed (1 Compressor)

VS2 = Variable Speed (2 Compressors)

DS = Digital Scroll

DS1 = Digital Scroll (1 Compressor)

DS2 = Digital Scroll (2 Compressors)

HP = Heat Pump

HR = Heat Recovery

HR-3HX = PolyTherm (Water-Cooled)

HR-3HX = EcoTherm (Air-Cooled)

FC = Integral Free Cooling



Model Number and Coding

When contacting Trane for technical support, customer service, or parts information, be prepared to provide the model number and serial number of the chiller modules in question. This information is located on the blue plastic chiller nameplate that is affixed to each module in the following figure.

Chiller Model and Serial Numbers

For future reference, record the model number and serial number for each module in the chiller in the table below, Chiller Reference Data. Refer to the Trane nameplate on each module in the installed unit for the serial number and model number. See figure below for example nameplate.

Table 1. Chiller reference data

Module	Model Number	Serial Number
1		
2		
3		
4		
5		
6		
7		
8		
9		
10		

Model Number

Critical information for contacting Trane technical support. Reference to the actual chiller module serial number may also be beneficial. Each module has its own unique serial number.

Model Coding Key

Model numbers assigned to Trane systems provide a wealth of information about the features for a chiller's "as-built" configuration.

Figure 1. Typical SuperMod™ water-cooled chiller nameplate

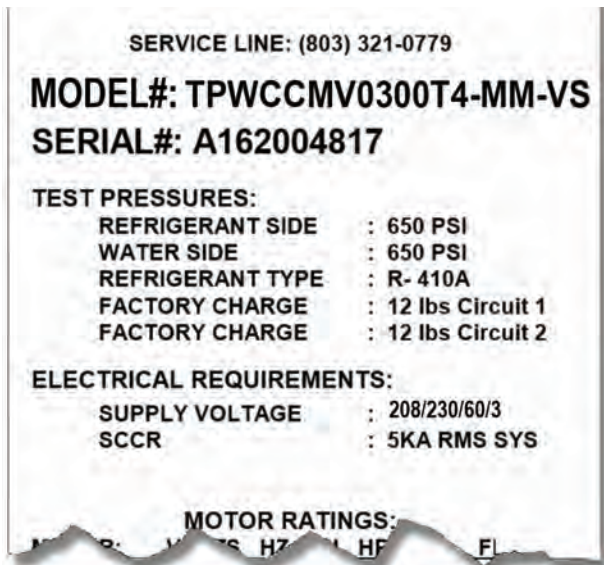



Chiller Description

Chiller Scope

This manual provides relevant data to properly operate, maintain, and troubleshoot the Trane SuperMod™ Water-Cooled Modular Chiller. Operator and maintenance personnel must be a qualified refrigeration technician and have a working knowledge of high voltage systems, low voltage control circuits, and components and functions.

Chiller Capacities

The SuperMod™ Chiller model is available in 10-, 12.5-, 20- 25-, 30- and 40- ton capacity modules. Up to 10 modules may connect together in a standard primary/secondary control system. The system consists of a primary chiller module that contains the primary microprocessor controller, the power distribution panel, one or more secondary modules. It is important to connect modules in the correct sequence as detailed in Handling of the Modules section of the Installation Mechanical chapter.

The SuperMod™ Chiller uses independent refrigeration circuits in each module using scroll compressors. Models are available with either brazed-plate or shell-and-tube evaporators. The brazed-plate evaporator is typically made of SAE Grade 316 stainless steel and 99.9% copper brazing materials. Standard interconnecting headers are composed of carbon steel.

Tandem Variable Speed Compressors



SuperMod™ Chiller uses a tandem set of fixed speed and variable speed compressors. The variable speed compressor uses brushless permanent magnet motors. The Copeland compressor uses the CoreSense technology as a sensor to unlock advanced capabilities such as protection, diagnostics, communication, and verification. Technicians can make faster, more accurate decisions resulting in improved compressor performance and reliability.

Water quality must be monitored and maintained by a water treatment professional familiar with the materials of construction and operation of the equipment. The chiller modules arrive fully charged with refrigerant. As required under Federal regulations, installation, initial start-up, and technical servicing should only be performed by fully qualified personnel.

⚠ WARNING

Hazardous Voltage!

Failure to disconnect power before servicing could result in death or serious injury.

Disconnect all electric power, including remote disconnects before servicing. Follow proper lockout/tagout procedures to ensure the power can not be inadvertently energized. Verify that no power is present with a voltmeter.

Component Description

Every chiller is comprised of four basic components: compressor, condenser, expansion valve, and evaporator. Each SuperMod™ Chiller module contains one or more of these primary refrigeration components.

Variable Speed Drive



The Emerson Copeland Scroll EVC1150B/1185B Variable Frequency Drive (VFD) delivers maximum machine performance with sensorless permanent magnet motor control, for dynamic and efficient machine operation. The drive is designed to control a compressor in one of two modes. The analog / digital control mode and the Modbus control mode.

Brazed Plate Condenser



The condenser is a key chiller component that receives refrigerant in the form of gas from the compressor and changes it to liquid that absorbs the heat dissipated by a cooling tower or ground source well system.

Optional Shell and Tube Condenser

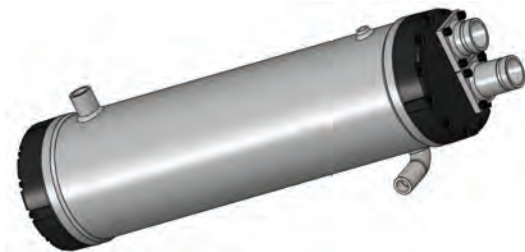

The optional shell and tube condensers are independent, cleanable shell and tube types with copper inner tubing and a steel shell.

Brazed Plate Evaporator

The evaporator is a brazed plate heat exchanger is constructed as a plate package of corrugated channel plates with filler material between each plate. The filler material forms a brazed joint at every contact point on the plates, creating complex channels. This allows fluid to come into close proximity with the cold refrigerant - separated only by channel plates - that enable efficient heat transfer from the refrigerant to the fluid.

Models with the brazed plate heat exchanger are typically made of SAE Grade 316 stainless steel and 99.9% copper brazing materials. Interconnecting headers are carbon steel.

Note: *A optional configuration with shell and tube evaporators having a fluid-filled carbon steel outer shell and copper tubing filled with liquid refrigerant may be found in some chillers.*



Pre-Installation

Preparation for Initial Startup

After the system is completely installed with all wires connected and all piping securely coupled, the chiller can be prepared for initial startup.

Ensure there is a sufficient cooling load available for proper testing of the chiller system.

⚠ WARNING

Hazardous Voltage!

Failure to disconnect power before servicing could result in death or serious injury.

Disconnect all electric power, including remote disconnects before servicing. Follow proper lockout/tagout procedures to ensure the power can not be inadvertently energized. Verify that no power is present with a voltmeter.

Initial Startup

1. Close all drain valves and header purge valves.
2. Fill the chiller with clean water/glycol mixture.
3. Inspect all connections for leaks during the filling process.
4. De-energize chiller using industry-standard lockout/tagout procedures. Verify main power is turned off at the power distribution panel. Validate de-energization using voltage meter.
5. Inspect all electrical connections to ensure terminals are secure.
6. Inspect all fuses and overload settings to ensure they conform to specifications.

7. Inspect all refrigerant pressures for each module to ensure no refrigerant has been lost.
8. Check that pressure switches and thermostats have correct "cut-in" and "cut-out" settings.
9. Confirm the oil level is correct in each compressor.

***Note:** If Trane pumps are provided, check that each pump's overload setting matches the nameplate amperage of the pumps as described previously. "Bump" pump motors on to verify correct rotation.*

NOTICE

Compressor Failure!

Failure to follow instructions below could result in catastrophic compressor failure.

Do not operate with insufficient oil.

10. Connect phase monitor wiring, if required.
11. Connect remote flow switch if the chiller is so equipped.
12. Ensure refrigerant valves are open at the compressors.
13. Confirm that pressure and temperature switches are in the closed position.
14. Apply power to all modules in the chiller.
15. Turn on the condenser and evaporator fluid pumps and ensure there is proper flow and the pressure drop across the system is as expected.
16. Monitor and record all temperatures and refrigerant pressures.



Pre-Installation

Table 2. Initial startup readiness checklist

<input type="checkbox"/>	Startup Readiness Dimension
<input type="checkbox"/>	Describe voltage service: <ul style="list-style-type: none"> <input type="checkbox"/> Fused disconnect <input type="checkbox"/> Non-fused disconnect <input type="checkbox"/> 50 Hz <input type="checkbox"/> 60 Hz
<input type="checkbox"/>	Record rated power supply: _____ volts _____ phase <ul style="list-style-type: none"> • Circuit breaker rating: _____
<input type="checkbox"/>	Record supply voltage on chiller nameplate: _____
<input type="checkbox"/>	Record power supply voltage to ground: L-1 = _____, L-2 = _____, L-3 = _____
<input type="checkbox"/>	Record voltage between each phase: L-1 to L-2 = _____, L-2 to L-3 = _____, L-1 to L-3 = _____ <ul style="list-style-type: none"> <input type="checkbox"/> Agrees with nameplate values? <input type="checkbox"/> Voltages must be within 2%.
<input type="checkbox"/>	Check the box if all electrical connections inside the power distribution panel are tight.
<input type="checkbox"/>	Check the box if all electrical connections inside each module electrical and control panel are tight. Ensure all components inside each module are securely mounted and have not shifted during shipment.
<input type="checkbox"/>	Record the control voltage between TB-1-1 and TB-2-1: _____
<input type="checkbox"/>	Check the box if chiller system includes any remote panels (city water switchover, remote control panel, or customer supplied control devices). If so, voltage drops are likely to occur. Measure and record all control voltages: List devices: Voltage 1 = _____ Voltage 2 = _____ Voltage 3 = _____
<input type="checkbox"/>	Check the box if there are any field-supplied wiring junction boxes located between the chiller and any remote panels.
<input type="checkbox"/>	Check the box if there are any splices made in the field-supplied wiring junction boxes.
<input type="checkbox"/>	Check the box if there are any customer-supplied devices connected to the chiller wiring. List devices: _____
<input type="checkbox"/>	Check the box if there are any Trane remote devices connected to the chiller wiring.
<input type="checkbox"/>	Check the box if voltage drops are detected.
<input type="checkbox"/>	Check the box if the appropriate water/glycol mixture has been added to the chiller.
<input type="checkbox"/>	Check the box if all chiller modules are installed with minimum clearances available from all sides.
<input type="checkbox"/>	Check the box if refrigeration gauges are indicating equal refrigerant pressures.
<input type="checkbox"/>	Check the box if chilled water lines from chiller to customer's equipment are permanently connected.
<input type="checkbox"/>	Check the box if chilled water lines have been flushed clean of mud, slag, and other construction debris.
<input type="checkbox"/>	Check the box if all chilled water line filters and strainers are clean.
<input type="checkbox"/>	Check the box if chilled water lines have been leak tested according to pre-startup instructions.
<input type="checkbox"/>	Check the box if chiller reservoir (if included) is at operating level with correct water/glycol mixture.

Table 2. Initial startup readiness checklist (continued)

<input type="checkbox"/>	Startup Readiness Dimension
<input type="checkbox"/>	Check the box if high voltage wiring is installed, tested, and functional.
<input type="checkbox"/>	Check the box if all water, refrigeration, and electrical connections between chiller modules are completed.
<input type="checkbox"/>	Check the box if all control wiring between modular chillers is installed, tested, and functional.
<input type="checkbox"/>	Check the box if control wiring is complete, including any additional remote interface panel or special-purpose wiring.
<input type="checkbox"/>	Check the box if all responsible installing contractors and sub-contractors have been notified to have representatives available on site to provide technical support for the initial start-up procedure.
<input type="checkbox"/>	Check the box if full load will be available for chiller on the initial start-up date.
<input type="checkbox"/>	Touchscreen Interface Panel: Record version and date of the software loaded into the touchscreen interface panel: Version: _____ Date: _____ Note: To view the software version, from the home screen, press the software button on the System Control screen.



Installation Mechanical

Inspect and Report Damage

Upon receipt, inventory the shipment against the Trane bill of lading to ensure all modules and components have been delivered.

Inspect each package in the shipment for visible damage. Verify the correct model number and that all skids and cartons have been delivered. Any damage must be reported to the motor carrier and Trane within five days of receipt of the shipment.

Inspect all exterior components for concealed damage as soon as possible. Do not proceed with the installation of damaged equipment without prior approval of Trane.

Do not refuse delivery of damaged goods without prior authorization. Unauthorized refusal of the shipment will result in a 20% restocking charge to the customer.

The ownership of the equipment is transferred to the consignee at point of shipment. Refusal of delivery may impede recovery of damages.

It is the consignee's responsibility to accept delivery of damaged goods unless permission to refuse delivery has been granted by Trane.

Inspection of Delivered Equipment

To report damage incurred in transit, complete the following:

1. Inspect each piece of equipment for visible damage before accepting delivery. Check for torn cartons, broken skids, bent metal and torn shrink wrap.
2. Ensure the delivery driver notes any damage on the bill of lading and completes a Carrier Inspection Report. Failure to comply may result in difficulties in resolving any claims for damage.
3. Inspect each piece of equipment for concealed damage before storage or as soon as possible after delivery.
4. In the event of suspected concealed damage, ask the driver to wait until you inspect the equipment. Concealed damage must be reported within five days of receipt of equipment.
5. If concealed damage is found, stop unpacking the shipment. Do not remove damaged material from the receiving location, take photos of the damage. The owner must provide reasonable evidence that the damage did not occur after delivery.
6. Notify the carrier of the damage as soon as possible. Request an immediate joint inspection by the carrier and consignee. A determination of responsibility will be made and the carrier will authorize repairs in the event of admission of fault.
7. Notify Trane customer service department (803-321-1891) immediately. Trane will coordinate

repairs with the owner and carrier. Do not attempt to make repairs locally without permission.

Warranty Issues

Trane is not responsible for damages or for filing damage claims. It is the customer's responsibility to ensure that the necessary long term storage procedures have been completed and any deviations are reported to Trane immediately.

Long Term Storage Requirements

Appropriate preparation and storage of Trane chiller components during extended periods of dormancy is essential to ensure the equipment does not sustain damage or degradation due to inactivity and operates properly after installation.

The customer must notify Trane during the sales process that the chiller system may be transported by ocean freight or placed in long-term storage under any of these conditions:

- The chiller will not be placed into operation for a period exceeding six months after leaving the Trane factory. That is, the initial start-up date will not occur within a six-month maximum dormancy window.
- The chiller will be shipped using ocean transit for all or part of the delivery process.
- Cold temperature storage conditions fall below -20 ° F (-29 ° C).
- Ambient temperature storage conditions exceed 150 ° F (66 ° C).

Factory Preparation

Upon confirmation of an order requiring long-term storage or protection against extreme environments, Trane will inspect and protect vendor-supplied components before installation.

Prior to shipment, Trane will prepare each chiller system for long-term storage in coastal or tropical environments by:

- Placing silica gel packs in all electrical panels and variable speed drive panels to prevent corrosion of electrical contacts and moisture from degrading sensitive controllers.
- Shrink-wrapping each chiller using polyethylene film to limit environmental exposure and protect the chillers from damage during shipping.
- For multiple modular chiller system assemblies shipped on a common skid, shrink wrap the entire skid rather than the individual modules.

Trane will document and photograph the status of the unit prior to shipment and carry out the instructions detailed in the factory order regarding in-shop preparation of units for long-term storage.

Customer Responsibilities

Upon receipt of a chiller system, the customer must conduct thorough internal and external inspections, removing packaging material as needed for access to all components.

Visible damage must be noted on the signed and dated bill of lading. The customer may request a carrier inspection by telephone or in person, but any such request should be confirmed in writing. It is recommended that the customer request that the carrier inspect the damage within 72 hours of notification.

The customer must store the chiller system in a dry, non-corrosive, dust- and vibration-free environment due to the exposure sensitivities of the microprocessor controllers and to prevent electrical terminations from deteriorating from non-use. Conditions in storage locations should not fall below -20 °F (-29 °C) or exceed 150 °F (66 °C).

Components sealed in plastic shrink-wrap are not exempt from these storage requirement. Moisture can potentially collect inside the plastic film, resulting in corrosion of the cabinet and electronic components. Any chiller system packaging that is removed must be replaced with similar protective covering as soon as possible.

Failure to adhere to these long-term storage requirements may void the Trane warranty. Any component that is damaged or inoperable due to improper storage may have its warranty voided.

Handling of the Modules

The packaging from the factory permits lifting with a suitable crane. Ensure straps are in good working condition and that they are rated for the weight of the machines. Spreader bars may be required for effective rigging and to avoid damage to the chiller modules.

The chiller modules arrive fully charged with refrigerant. As required under Federal regulations, installation, start-up and service should be performed by fully-qualified, factory-certified, personnel.

⚠ WARNING

Proper Field Wiring and Grounding Required!

Failure to follow code could result in death or serious injury.

All field wiring **MUST** be performed by qualified personnel. Improperly installed and grounded field wiring poses **FIRE** and **ELECTROCUTION** hazards. To avoid these hazards, you **MUST** follow requirements for field wiring installation and grounding as described in NEC and your local/state/national electrical codes.

⚠ WARNING

Electrical Shock, Explosion, or Arc Flash Hazard!

Failure to follow these instructions could result in death or serious injury.

- **Install the product in an appropriate electrical/fire enclosure per local regulations. Do not install the product in hazardous or classified locations.**
- **Do not use the product for life or safety applications.**
- **Do not exceed the product ratings or maximum limits. Products rated only for basic insulation must be installed on insulated conductors.**
- **Current transformer secondaries (current mode) must be shorted or connected to a burden at all times.**
- **Remove all wire scraps, tools, replace all doors, covers and protective devices before powering the equipment.**

Site Preparation and Clearances

Chiller modules must be installed on a level surface that has been checked by a qualified structural engineer to support the weight of the fluid-filled modules and the connective piping to and from the chiller. Installations must account for minimum service access clearances as may be practical or required by local building codes.

Chiller Clearances

The National Electric Code or local, state, and regional building codes may require greater clearance for the modular chiller than the figures listed in this publication. Always consult local regulatory agencies to ensure additional clearances are not required by building codes.

Minimum Clearances

The unit must maintain a minimum of 36 inch clearance on all sides. See [Figure 2, p. 16](#).

Note: *These clearances are general recommendations. Each installation has specific considerations. Contact Trane for definitive guidance and approval on a job-by-job basis.*

Figure 2. Recommended chiller clearances

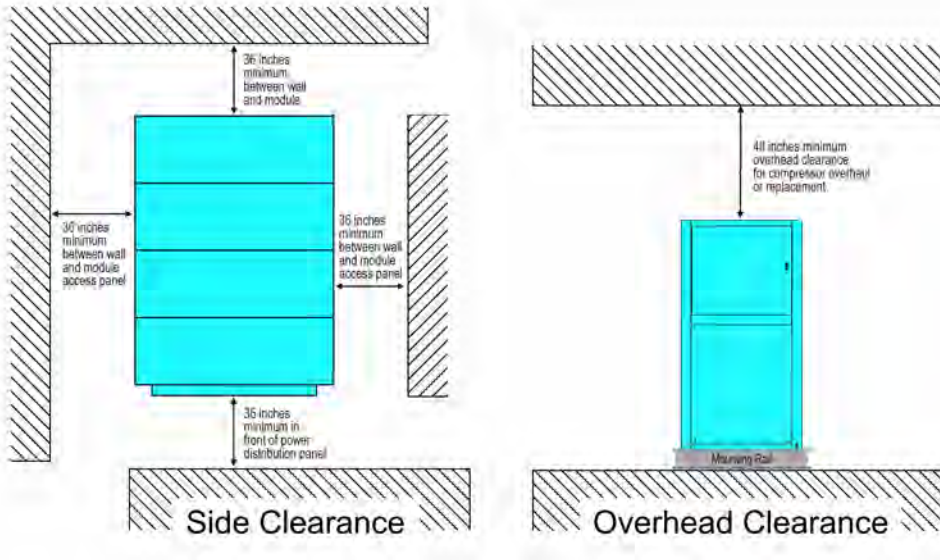

Service Access

Compressors, filter-strainers, and liquid line shutoff valves are accessible on each side or end of the unit.

Rigging, Lifting, and Moving the Chiller

The SuperMod™ Water-Cooled Modular Chiller can be delivered to the customer's site as individual modules or as previously assembled single units, depending on customer requirements and preferences. Limitations on the methods and materials that can be used to rig, lift, or move a chiller or an individual module include:

- Maintain the module in an upright position at all times.
- Certain configurations of modules can be top-heavy. Move modules slowly with consideration for each module's center-of-gravity.
- Rig, lift, and move by strapping and lifting using a properly configured floor jack or fork lift or by overhead means.
- Position lifting beams to prevent lifting straps from rubbing or contacting module side panels or electrical boxes.
- Do not use cables, chains, or any other type of metalized strapping to lift a module.
- Do not push a chiller module while directly in contact with the floor using manual or mechanical means.

Figure 3. Recommended chiller rigging assembled unit

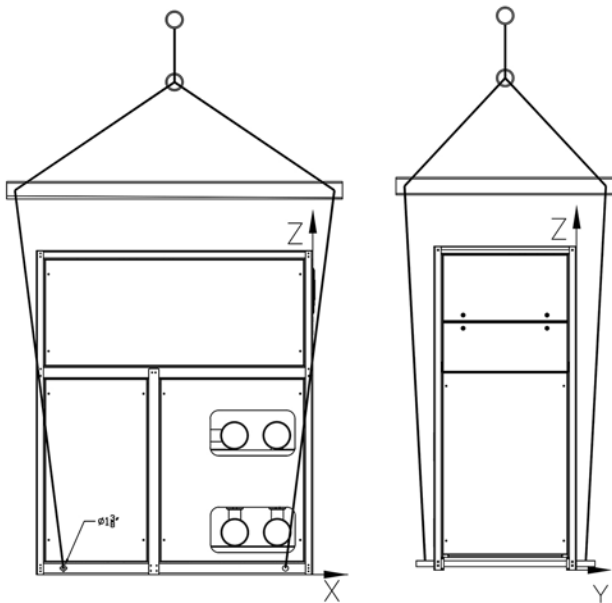

Mounting Rails

When modules are installed onto structural steel rails, the rails must be level such that the modules are properly aligned. Mounting rails must be a minimum of 4 inches wide. Custom modules may have different requirements. Consult submittal drawings to confirm dimensions. See [Figure 4, p. 17](#).

After setting and lubricating the mounting rails, begin installing the modules. All of the modules arrive with labels on the electrical and control panel. Review the installation drawings to determine which is the first, primary, module. Typically the primary module also has the power distribution panel attached to it.

Figure 4. Chiller installation on mounting rails

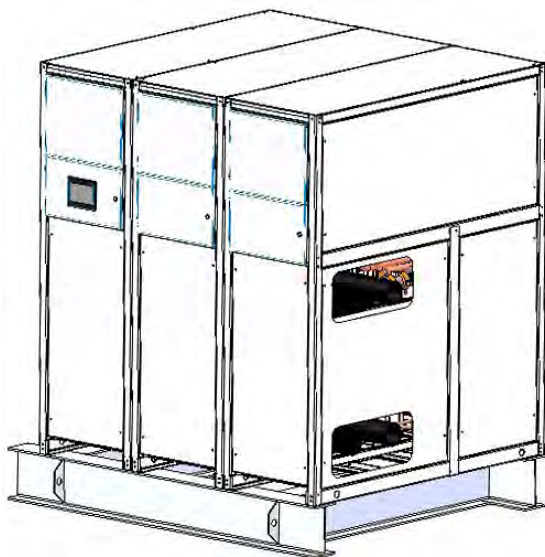

When installing modules onto a concrete pad, rubber-inshear isolator pads may be installed under each

module. After setting each module, remove front or rear access panels to improve access to components when making connections.

Installation Piping

Install Piping and External Components

Proper support of piping and pipe hangers must consider the weight of the piping as well as the water

weight inside the pipes. A 40-mesh screen strainer must be installed in each water/liquid system piping inlet for proper filtration and protection of the heat exchangers. The following figure provides a recommended installation of components.

Figure 5. Recommended chiller piping

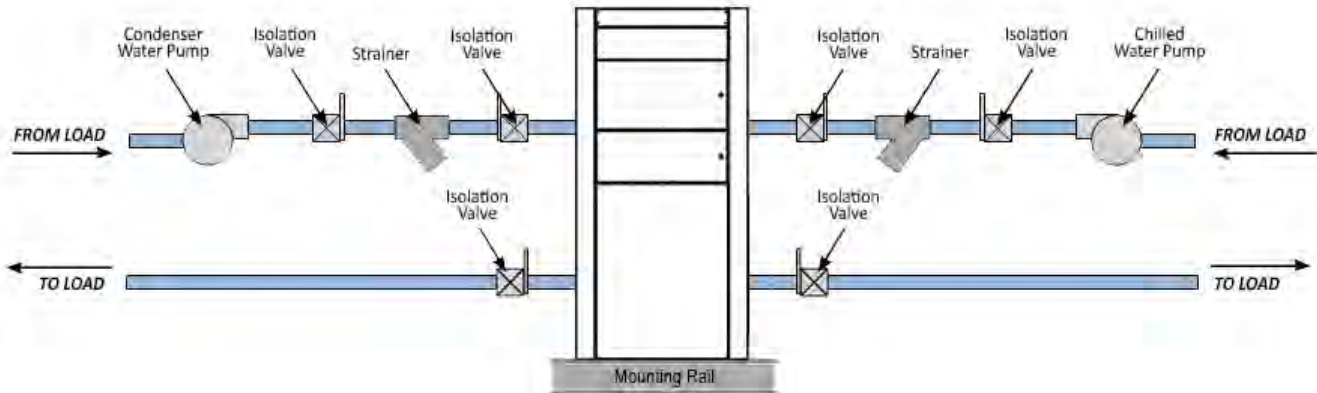

Initial Flushing of Piping

After installation of system piping and before connection to the chiller system, it is important to clean and remove debris, weld slag, and other contamination deposited during fabrication of the piping system. Typical flushing includes hot water with mild detergent followed by a dilute phosphoric acid solution until all visible residue is removed.

Only cleaning liquids, acids, and detergents compatible with SAE Grade 316 stainless steel, copper, and carbon steel should be used. Consult a professional water treatment specialist when in doubt.

Flushing should take place across a filter/strainer with a maximum 30 mesh screen and continue for a minimum of six hours with frequent removal of the screen to capture residue or until the strainer is clean.

After detergent and chemical cleaning, flush the water piping with fresh water for one hour to remove any remaining cleaning compounds.

ID10 needs to be verified with CPCO controller.

Fill with Water/Glycol Solution

The installing contractor is responsible for charging glycol into the chiller hydronic system.

1. Mix the concentrate of propylene glycol in a tank or drum for transfer into the chiller. Use [Table 7, p. 37](#) to determine the appropriate glycol concentration.
2. Mix the glycol and water externally before filling the chiller to prevent clogging of the chiller piping with a heavy concentrate.

3. For chiller system with tank and pump module and sealed buffer tank, fill the chiller using the manual fill port on the cabinet. Fill so that the mixture reaches near the top. Stop every so often so the fill level can be monitored.

Note: Do not use the glycol feeder pump to fill the chiller loop. It is not designed for continuous use and will fail.

Only after the above steps have been completed should the water piping be connected to the chiller system.

Dowfrost

Important: Dowfrost inhibited propylene glycol-based solution is listed as chemically acceptable by the US Department of Agriculture (USDA). The two ingredients in Dowfrost water/glycol mixture are generally recognized by the FDA as safe food additives under Parts 182 and 184 of the Food Additive Regulations.

Connecting Module Couplings

Install each module according to its position number indicated on its electrical distribution cabinet. Install the primary module first. Each secondary module has the same installation procedure as the previous module.

1. Remove the coupling that attaches the headers to the heat exchangers in order to position the header with the next module and attach the header coupling.

2. Remove all four small couplings to allow the main headers to slide into the previous module.
3. Position each subsequent module approximately 16-inch from the previous module when positioning the headers.
4. Lubricate the main header coupling gasket with an approved lubricant and re-install onto the roll grooved header pipe. Push the gasket flush with the pipe end to avoid damage when installing the next module.
5. Remove the coupling that attaches the main header to the heat exchanger.
6. After positioning the module, slide the header and rotate it to avoid damage to the refrigeration piping.
7. Note the refrigeration pipe above the header. Note the position of modules and headers extended.
8. Position each of the four headers and attach the roll grooved couplings. Start by positioning the lubricated gasket so that the gasket fits inside the two grooves, one from each of the headers.
9. Loosen one side of the metal coupling and remove the bolt from the other side to allow you to position it over the gasket.
10. Install and tighten each of the four couplings. Begin with the inside headers, then the outside headers. Slide the module back to the previous module and re-attach the header to the small coupling for the heat exchanger.
11. Install the remaining modules using this procedure.



Installation Electrical

Connecting Module Power and Control Wires

Connections are made at the primary module, which typically contains the power distribution panel .

⚠ WARNING

Proper Field Wiring and Grounding Required!

Failure to follow code could result in death or serious injury.

All field wiring **MUST** be performed by qualified personnel. Improperly installed and grounded field wiring poses **FIRE** and **ELECTROCUTION** hazards. To avoid these hazards, you **MUST** follow requirements for field wiring installation and grounding as described in **NEC** and your local/state/national electrical codes.

This unit is equipped with a flow switch. The chiller will not run unless the pump is circulating water through the system.

Chiller Module Main Power

Modular systems feature single-point power connection from the utility service to the power distribution panel on the primary module as standard. Main power phases A, B, and C are connected to terminals A, B, and C respectively from left to right. Some systems have individual power supplied to each module in lieu of single point power.

Phase Monitor Installation

The chiller is equipped with a phase monitor on the power distribution panel. It communicates with the primary microprocessor controller on the primary module electrical and control panel via the ID8 terminal. Ensure that the wiring from the primary microprocessor controller and terminal blocks to the phase monitor are connected and secure.

The phase monitor continuously monitors each of the three phases. The microprocessor receives input from the phase monitor indicating whether the voltage is within acceptable values. The phase monitor is designed to protect against under-voltage, voltage imbalance, phase loss, and phase reversal.

Set voltage adjustment knob at the desired operating line voltage for the equipment. This adjustment automatically sets the under-voltage trip point. Check the phase monitor after initial startup. If it fails to energize, (the LED glows red or blinks) check the wiring of all three phases, voltage, and phase sequence. If

phase sequence is incorrect, the LED flashes green/red. To correct this, swap any two line voltage connections at the mounting socket. No further adjustment should be required.

Power Interlock Switch

Some SuperMod™ Chiller systems are optionally equipped with a panel-mounted disconnect switch installed on the outside of the power distribution panel. The disconnect switch must be turned to the off position before the panel can be opened for service.

⚠ WARNING

Hazardous Voltage!

Failure to disconnect power before servicing could result in death or serious injury.

Disconnect all electric power, including remote disconnects before servicing. Follow proper lockout/tagout procedures to ensure the power can not be inadvertently energized. Verify that no power is present with a voltmeter.

Single Point Connections

For systems with single point power connections, detach the power cable on each module by cutting the wire tie installed for shipping.

1. Uncoil the power cable and snake it through each module to reach the power distribution panel.
2. Feed the taped end of the cable through the round opening on the extreme left of the power distribution panel.
3. Remove the tape and connect and tighten the cable ends to the breaker corresponding to the module number being connected. (For example, connect the cable for module #9 to the breaker labeled #9.)
4. Connect the green ground lead to the ground lug at the base of the enclosure.
5. Do not secure the ground wire until all of the ground wires are connected to the ground lug and then each can be tightened.
6. After connection, secure all power cables with standard wire ties.

Module Control Wiring

The primary controller communicates with the secondary controller in each chiller module via a communication circuit. Each secondary controller is wired back to the Ethernet switch on the primary microprocessor controller.



Operating Principles

The SuperMod™ Water-Cooled Modular Chiller is designed to operate with a water/glycol mixture to prevent rust, scaling, and organic growth.

The SuperMod™ Chiller provides 44°F (7°C) water/glycol mixture under a maximum heat load with a maximum return temperature of 54 °F (12°C). The SuperMod™ Chiller typically uses an R410A, water-cooled mechanical refrigeration system.

The water/glycol mixture is cooled via a compact, brazed plate evaporator. An externally adjustable electronic expansion valve meters the proper flow of

refrigerant to the evaporator where it evaporates and the heat in the system water/glycol mixture transfers to the refrigerant. The compressor then compresses the vapor to a higher pressure so that the condensing pressure of the refrigerant is at a higher temperature than the condenser fluid that is used to condense it. The condenser then condenses the vapor to a saturated liquid, and further cools it so that it reaches the expansion valve as a saturated liquid, to complete the basic cycle.

Operating Procedures

Operator Interface

All SuperMod™ water-cooled chiller module systems - composed of a single module or up to 10 modules - are automated systems. A 7-inch touch screen operator interface with graphical display is installed on the primary module to allow chiller operation monitoring, adjustment of user set points, and alarm monitoring.

Chiller Power Panels

There are two different electrical panels used in the SuperMod™ Chiller. The main power distribution panel receives power from the building power source and distributes it to individual modules. The electrical and control panel receives power from the power distribution panel and provides power to the individual electrical components in that module.

Figure 6. Power distribution panel

Panel-Mounted Disconnect Switch

Some SuperMod™ Chiller systems are optionally equipped with a panel-mounted disconnect switch installed on the outside of the power distribution panel (or on each module's electrical and control panel if the chiller has power supplied to each individual module). The disconnect switch must be turned to the OFF position before the panel can be opened for service. When the panel door is open, the power is disengaged.

Power Distribution Panels

The power distribution panel distributes electricity from the external building power supply. It also houses a circuit breaker for each module, a phase monitor, and an optional main power disconnect switch. See following figure.

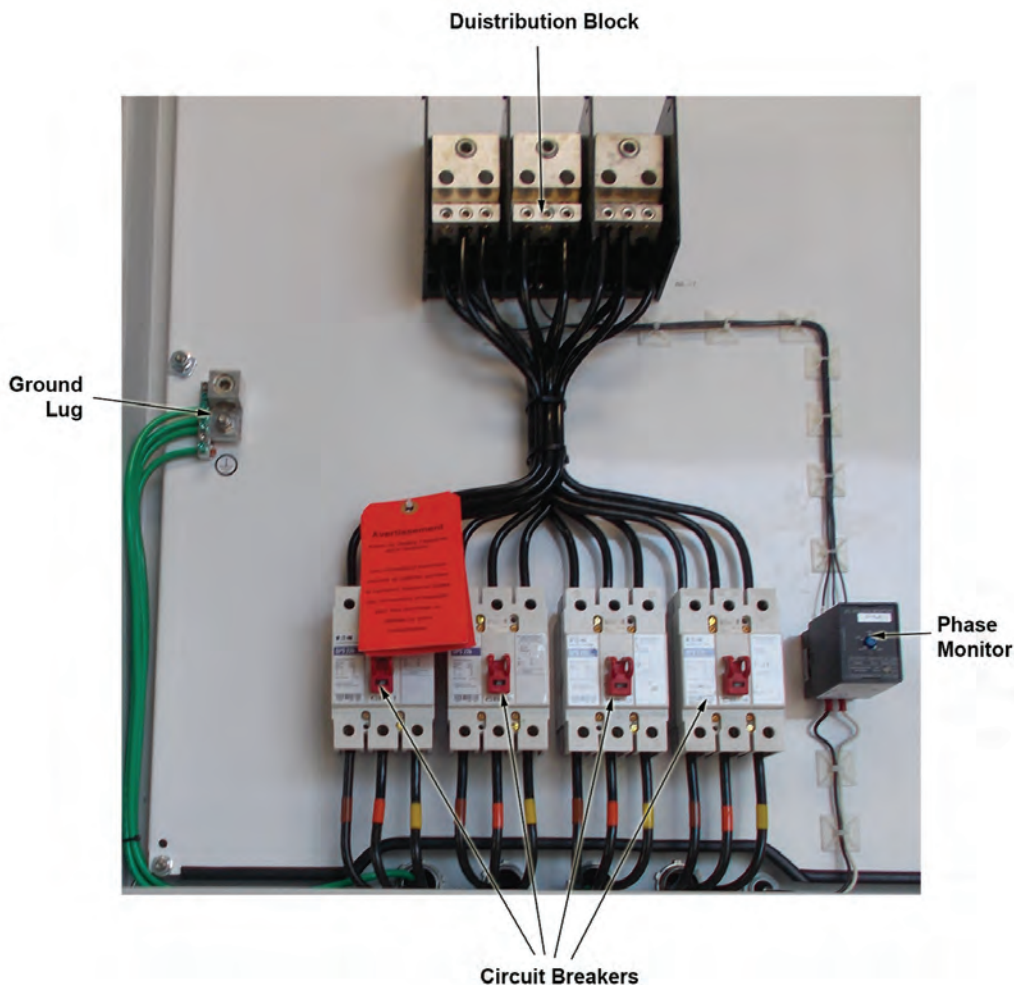

Module Electrical and Control Panel

Each module has its own electrical and control panel that distributes electricity to individual components. It

also has fuses and breakers, compressor switches, and the microprocessor controller. See following figure.

Figure 7. Module electrical and control panel

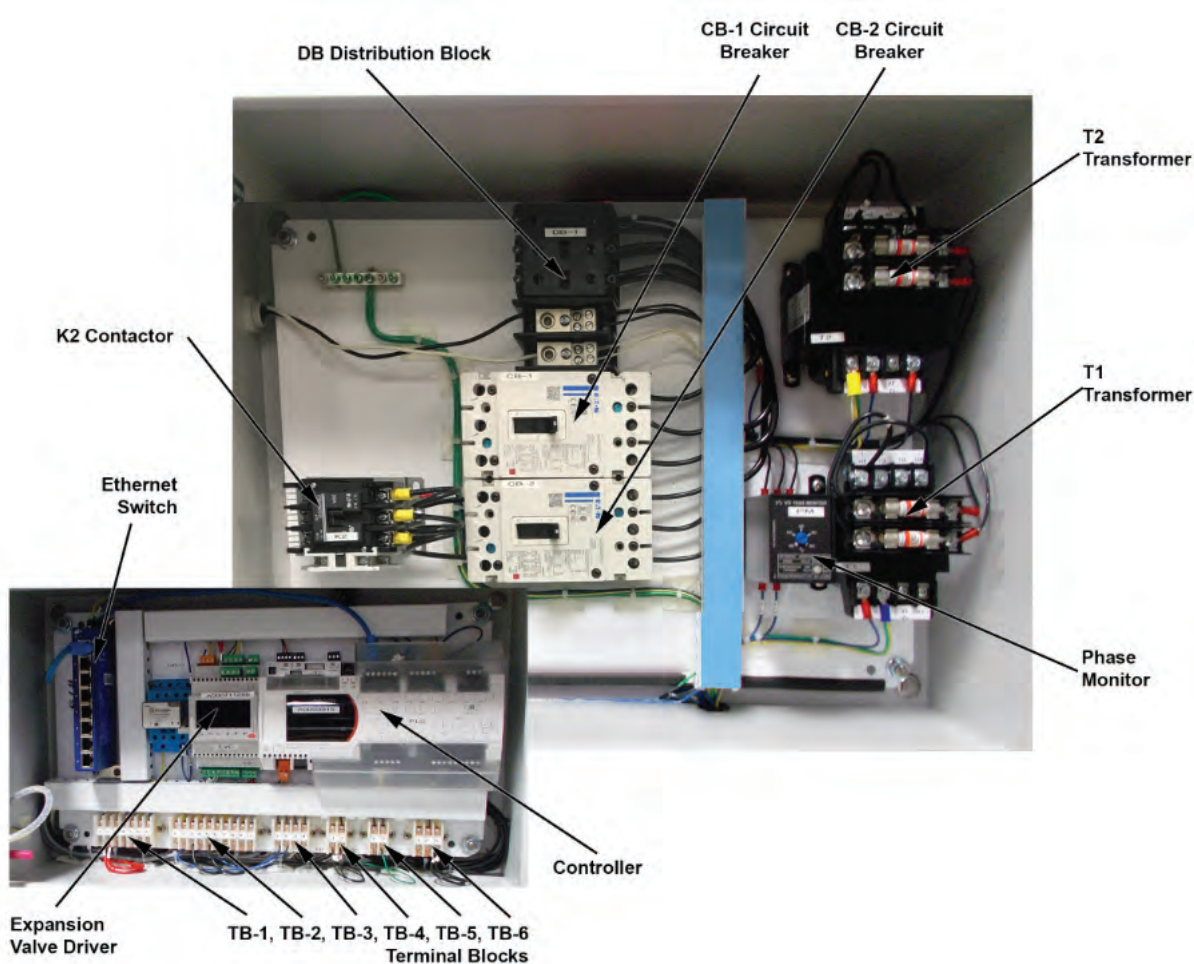

Electronic Control

SuperMod™ Water-Cooled Modular Chiller models use Carel c.pCO series microprocessor controllers to monitor and report critical operating parameters. See [Figure 9, p. 24](#). A primary controller is used to control and coordinate the functioning of all the modules that make up the chiller system. Each module has its own controller.

There are five BMS communication options:

Note: BMS is not included as standard, but available as an option.

1. BACnet® MS/TP - Connection through built-in BMS2 port.
2. BACnet IP - BACnet router is used.
3. Modbus™ RTU - Connection through built-in BMS2 port.
4. Modbus IP - Modbus router is used.

5. LonWorks® - LonWorks router is used.

Controllers

The distributed microprocessor control system enables all secondary modules to operate independently in the event that the primary microprocessor controller fails. All chiller safeties including temperature set point, refrigerant pressures, and freeze protection are preserved. The distributed microprocessor control programming only lacks the ability to rotate the lead compressors which typically occurs every 168 compressor operating hours.

In a normal configuration, a secondary controller controls the single module to which it is dedicated.

The secondary controller monitors key performance parameters for its module and sends real-time information to the primary controller. The primary controller monitors the performance of the chiller,

activating and deactivating modules as needed to maintain the leaving water temperature for the chiller.

(See the following figure for a simplified example of a typical microprocessor controller network.)

Figure 8. Typical controller network

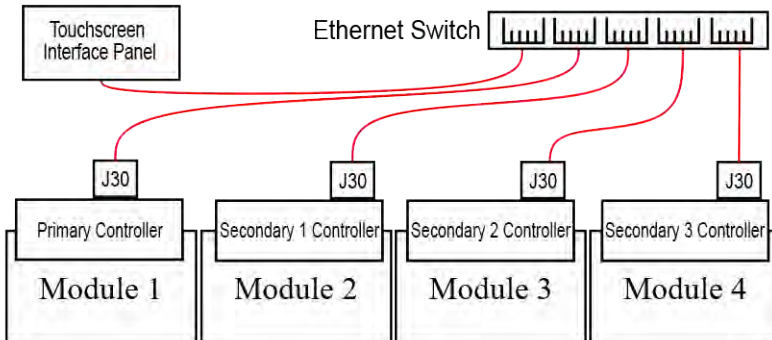

Figure 9. Carel medium c.pCO primary controller



Operating the Microprocessor

The touchscreen interface panel is ready to use when it is connected to the Ethernet switch and chiller power is ON.

Upon initial startup, the status line will indicate that the chiller is OFF. Press and hold the ON/OFF button on the touchscreen interface panel; for few seconds to turn the chiller ON. The status line on the LCD screen of the primary module will indicate that it is powered.

Press and hold ON-OFF button to toggle the chiller ON and OFF.

Microprocessor Functions

For practical purposes, all essential control information and operator actions are read and responded to using the touchscreen interface panel. The touchscreen interface panel is connected to the primary microprocessor controller and is the only way to access many primary controller functions.

NOTICE

Component Damage!

Failure to follow instructions could damage sensitive electronic components beyond repair. To prevent arcing or surges of electrical current, do not use wires or cables to jump components or bypass the manufacturer's safety systems.

Password Protection

There are three levels of access to the functions displayed on the interface. The basic level, 'user,' does not require a password. The higher access levels are the technician ('tech') and administrator ('admin') levels that can only be accessed by Trane technical personnel. Contact Trane technical support regarding the possibility of any potential issues involving the higher-level functions.

Operator Control

A touchscreen interface panel is the primary means for the operator or maintainer to monitor and modify a host of functions involving temperatures, pressures, set points alarms, operating schedules, and elapsed operating hours. This touchscreen interface panel is located inside the control panel, it is typically located in the primary module.

The touchscreen interface is connected to and communicates with all module controllers via the Ethernet switch. It accesses overall chiller/heater functions and settings as well as individual module settings.

In this manual, all functions, procedures, checklists, system information, and changes in system parameters (set points, alarms, primary chiller controls, and so forth) are written assuming the operator is using the touchscreen interface panel.

When connected to the Ethernet switch, the touchscreen interface panel displays current, real-time,

information about the chiller, as well as the status of critical parameters within each module of the chiller.

Touchscreen Interface Panel

The touchscreen interface panel is used to adjust set points, clear alarms, and perform detailed setup of the microprocessor controllers.

The touchscreen interface panel displays information on its touchscreen whenever specific keys and buttons are pressed by the operator (See following figure).

Basic operator tasks are described in the following sequence of illustrations that comprise a controller tutorial.

Figure 10. Touchscreen interface panel



Touchscreen Interface Tutorial

This section consists of a tutorial that first-time personnel can use to navigate through the various functions and features that are available in the interface.

Each of the main screens in the interface contains active hot spots to activate virtual buttons and switches by simply touching the screen.

Interface Menu Structure

Key interface screens are organized according to system, primary module, and secondary modules functions. See [Figure 11, p. 26](#).

Figure 11. Interface navigation scheme

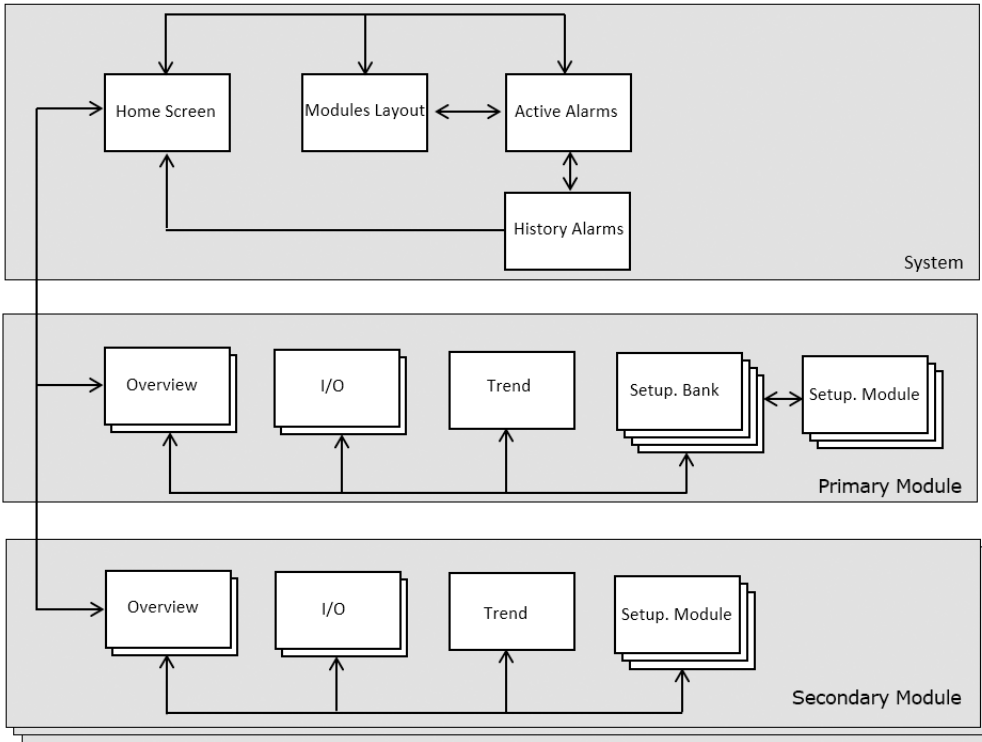

Home Screen Features

Figure 12. HMI home screen

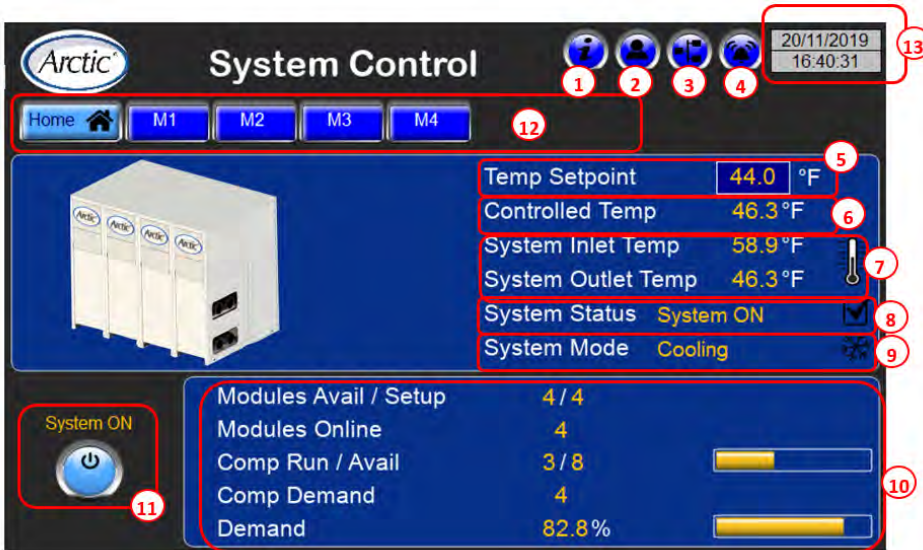

HMI Functions

1 - HMI Software Version

Calls up the pop-up window

Project Name: HMI software project name; Software Version.: HMI software version. Consists of 4 two-digit

numbers. First 2 numbers: major and minor software revision. Third number stands for special software revision. If any project has the special software, this number would be different from '00'. Fourth number stands for beta software revision.

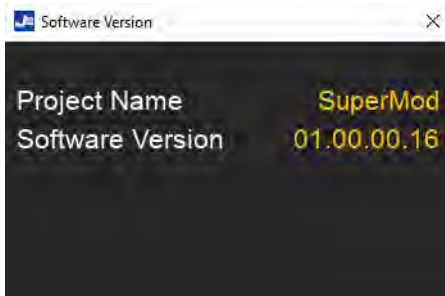

2 - HMI User Management / Login

Current User: indicates which user is currently logged in. There are three users for the HMI: 'user', 'tech' and 'admin'.

- user - (default user) has access to viewing data mostly. The only allowed controls for this user are: turning chiller bank on / off and turning compressors on / off (described below). There is no password for this user;
- tech - higher access than user but still limited. Beyond 'user' 'tech' can adjust cooling / heating setpoints, turn separate modules on / off and has access to some machine basic temperature control settings (described below). Password is 'tech2';
- admin - full access to all the settings.

Log in: Calls up user logging screen where user name and password have to be entered

Log Out: unhidden for 'admin' and 'tech' users only. It logs out from 'admin' or 'tech' user to a default user, which is 'user.'

Figure 13. User logging screen

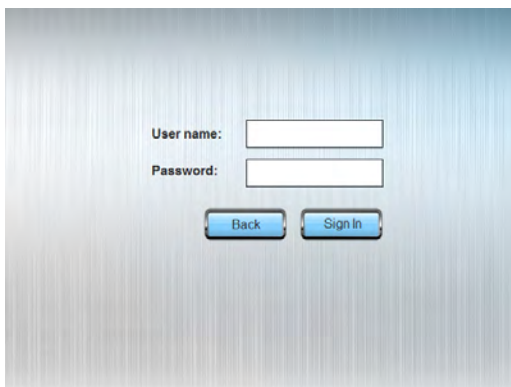

3 - Module Layout Access

The module layout access button provides fast access to the module layout screen.

4 - Active Alarm Access

The active alarm access button provides fast access to a list of currently active system alarms.

5 - Setpoint

Calls up cooling / heating setpoint pop-up screens respectively depending on the Mode. Accessible for 'tech' only. These boxes themselves display the resulting cooling / heating setpoint used for machine temperature control. Note: The only box on these pop-ups accessible for 'tech' user. The other settings are view-only. See [Figure 14, p. 27](#)

Figure 14. Cooling / heating setpoint



6 - Controlled Temperature Reading

7 - System Temperature Sensors Reading

Based on chilled water entering / leaving temperatures for Cooling Mode and hot water temperatures entering / leaving for Heating Mode

8 - System Status

Possible Options:

- System ON. System is not off by any of the conditions below.
- Phase Alarm. System is off by Phase Alarm if common Phase Monitor is used per chiller.
- OFF by DI. System is off by opened state of primary PLC DI1 if corresponding option applies.
- OFF by Switch. System is off by software switch. It can be turned on / off either from Home Screen (button marked 11 on figure 1), which all users have access to. It can also be turned on / off from BAS (Building Automation System).

9 - System Mode

Indicates chiller thermal mode: Cooling or Heating.

10 - Module/Compressor Status

- Modules Avail/Setup. Number of modules available for primary/secondary temperature control and number of modules set up for primary/secondary temperature control.
- Modules Online. Number of chiller modules currently communicating with primary PLC including primary Module.
- Comp Run/Avail. Number of compressors currently running and number of compressors available for primary/secondary temperature control. Bar graph showing this ratio available as well.

Operating Procedures

- Comp Demand. Cooling or Heating Demand value in number of requested compressors as well as continuous value in %. There is also a bar graph representation of Cooling or Heating Demand beside the % value.

11 - Power ON/OFF

Press and hold this button to toggle the software switch which powers the chiller (and all its modules) on and off.



12 - Module Access

The module access buttons display the overview screen for each module. These buttons provide access to all chiller modules screens individually. The number on the Mx button stands for the module number in the chiller. Only modules that communicate directly with the touchscreen interface are viewable via the module access buttons.



13 - Date/Time

Current HMI date/time as set up in HMI system settings.

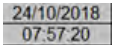

Modules Layout Screen

The chiller can be composed of up to a maximum of ten modules. Pressing the LAYOUT button displays the screen showing the status of compressors and valves in each module. See figure below.

Each module diagram is a set of symbols and colors that show the real-time status of the compressors, the refrigeration circuit, the isolation valves and the module overall. See figure below.

Figure 15. Modules layout screen showing four compressors on four modules

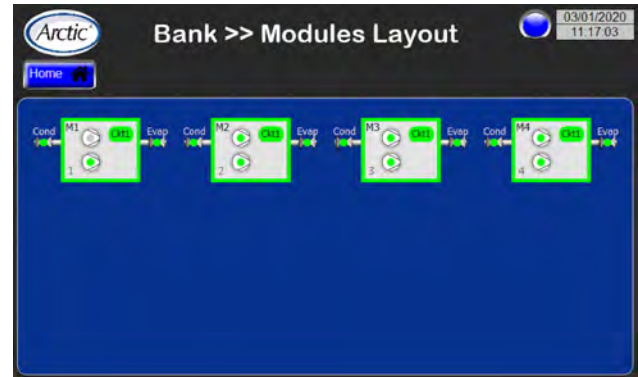

Module Layout Screen Status Conditions

Each module picture is a set of images that show real-time color-coded state of compressor, refrigeration circuit, isolation valves and module.

Table 3. Module status conditions

<p>Module is available</p>	<p>Module is unavailable</p>	<p>Module turned off by alarm and unavailable</p>
<p>Refrigeration circuit in normal state; Compressor ON</p>	<p>Refrigeration circuit is non-operational; Compressor OFF</p>	<p>Refrigeration circuit in alarm state; compressor OFF</p>
<p>Isolation Valves: - Valve LED is green = valve is open - Valve LED is gray = valve is closed</p>	<p>Compressor 1 is OFF; Compressor 2 is ON</p>	<p>Compressor 1 is ON; Compressor 2 is in alarm</p>

Active Alarms Screen

The active alarms screen lists all active (triggered) and non-active alarms in tabular form. See following figure.

Information presented in this screen in tabular form includes:

- Alarm is considered 'Active' (Triggered) if 'Source Value' = 1, other words it's still active in the PLC.
- If alarm is 'Not Active' (Not Triggered), its 'Source Value' = 0 and it can be reset using Reset button.
- Both 'Active' and 'Not Active' alarms can be acknowledged. When 'Not Active' alarm is acknowledged, it can be reset, which will remove it from the list, so only 'Active' alarms will remain on the list.



Select

This column indicates if the alarm is selected or unselected for acknowledgment or resetting.

ID

This column displays the descriptive title each alarm.

Figure 16. Active alarms for the chiller



Source Value

This column displays the numeric value of each alarm.

If an alarm has a Source Value = 1, it can only be reset with the RESET button when the condition triggering the alarm has been resolved.

If an alarm has a Source Value = 0, it can be acknowledged or reset, which removes it from the active alarms list.



State

This column displays the alarm state. There are four possible states for any alarm:

- TRIGGERED (ACTIVE) / NOT ACKNOWLEDGED

- TRIGGERED (ACTIVE) / ACKNOWLEDGED
- NOT TRIGGERED / NOT ACKNOWLEDGED
- NOT TRIGGERED / ACKNOWLEDGED

Both active and non-active alarms can be acknowledged. When a non-active alarm is acknowledged, it can be reset, which immediately removes it from the active alarms list.

When all non-active alarms have been acknowledged, only active alarms will remain on the list.

Description

This column describes the nature of each alarm.

Time

This column is the date-time stamp indicating exactly when the alarm occurred.

Check / Uncheck All

This button is used for selecting and deselecting all listed alarms with a single action.

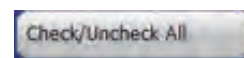

'Hide Not Triggered' Drop Down Menu

This is used to either list all the alarms, both active and non-active, or only active alarms (the default selection).

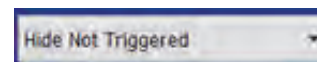

Ack

Pressing this button acknowledges the alarm and removes it from the active alarms list.

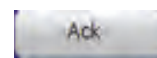

Reset

Pressing this button allows a specific non-active alarm to remain on the active alarms list.



Save

Pressing this button saves the changes made to the active alarms list. Any changes that are made without saving will be lost.

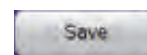

Reset PLC

This button, located in the upper right portion of the screen, resets the active alarms in the primary microprocessor, so they could be further acknowledged or reset on the touchscreen interface.

Operating Procedures

Only those alarms for which the alarm condition is 'false' can be reset in the microprocessor controller; otherwise, the RESET PLC button will have no effect.

A list of all chiller alarms are found in the Troubleshooting chapter.



Figure 17. Alarm history

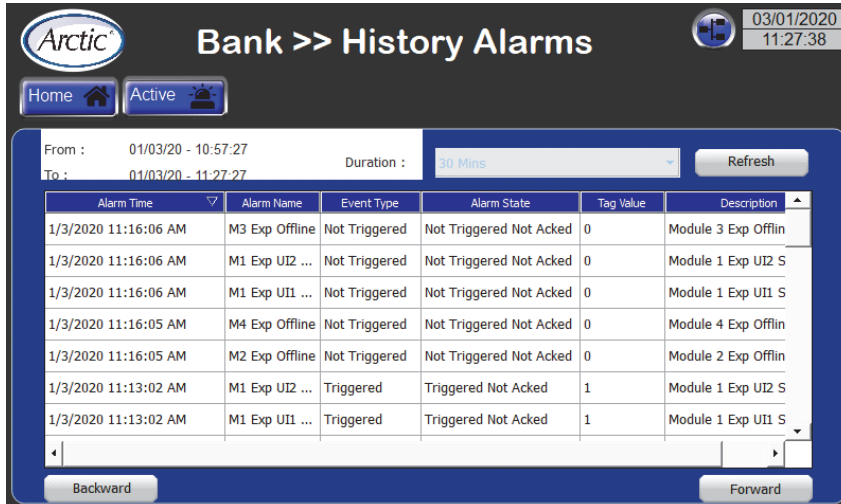

Alarm Time	Alarm Name	Event Type	Alarm State	Tag Value	Description
1/3/2020 11:16:06 AM	M3 Exp Offline	Not Triggered	Not Triggered Not Acked	0	Module 3 Exp Offlin
1/3/2020 11:16:06 AM	M1 Exp UI2 ...	Not Triggered	Not Triggered Not Acked	0	Module 1 Exp UI2 S
1/3/2020 11:16:06 AM	M1 Exp UI1 ...	Not Triggered	Not Triggered Not Acked	0	Module 1 Exp UI1 S
1/3/2020 11:16:05 AM	M4 Exp Offline	Not Triggered	Not Triggered Not Acked	0	Module 4 Exp Offlin
1/3/2020 11:16:05 AM	M2 Exp Offline	Not Triggered	Not Triggered Not Acked	0	Module 2 Exp Offlin
1/3/2020 11:13:02 AM	M1 Exp UI2 ...	Triggered	Triggered Not Acked	1	Module 1 Exp UI2 S
1/3/2020 11:13:02 AM	M1 Exp UI1 ...	Triggered	Triggered Not Acked	1	Module 1 Exp UI1 S

The alarm history screen displays the history of alarms recorded by the primary microprocessor (See [Figure 17, p. 30](#)).

Sort History Items

The alarm history list can be sorted by any column in ascending or descending order by tapping the corresponding column heading. The triangle that appears next to the heading indicates which column is being sorted and the direction of sorting.

Sorting is applied to the alarm time column in ascending order by default, which is indicated when the triangle is pointing up. Ascending order for the alarm time column requires that earlier records appear on the list first. For all other columns, alphabetical sorting applies.

Duration

Allows the selection of the time period for which the alarm history is displayed. Once the selection is made from the drop-down menu, pressing the REFRESH button updates the list and the 'From' and 'To' timestamps will update accordingly.

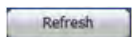

Alarm Time

This is the time stamp that is displayed when the alarm state changes.

Alarm History

On the active alarms screen, pressing the alarm history button displays the alarm history screen.



Event Type

This is the alarm event that is logged on the alarm record. Only active alarms (Event Type = Triggered) are recorded.

Alarm State

This is the same as 'State' for active alarms. Only two alarms states apply to alarm history screen:

- TRIGGERED / NOT ACKNOWLEDGED
- TRIGGERED / ACKNOWLEDGED

Tag Value

This is the same as Source Value for active alarms.

Modules Overview Screens

Each module controlled by the microprocessor controller has its own module screen within which the operator can monitor and maintain conditions affecting that module. Primary module access is made through the system control screen containing multiple controls and indicators:



On the home screen, pressing the **M1** button displays the Module #1 (primary module) overview 1 screen.

The overview menu is comprised of two screens:

Overview Module (primary and secondary) and Overview Circuits. Use the left and right scrolling buttons to scroll through the overview screens.

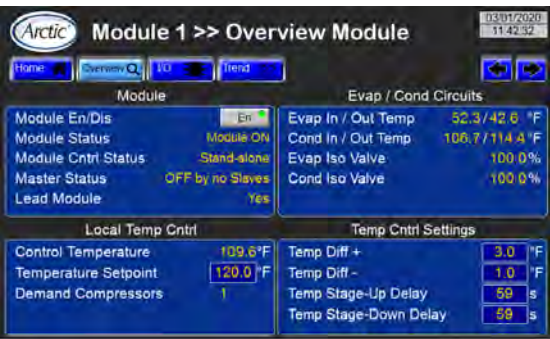
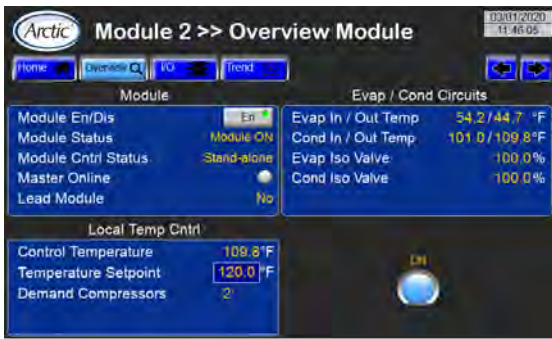

Table 4. The overview screens

 <p>Primary Overview Module Screen</p>	 <p>Secondary Overview Module Screen</p>
 <p>Primary/Secondary Overview Circuit Screen</p>	

Overview Module

Module En/Dis

Pressing this button enables or disables a module. It is used for testing and maintenance purposes. If module is disabled, it's excluded from primary control compressors sequence. Not accessible for 'user.'

Module Status

Possible options:

1. Module ON. Module is ready to run.
2. OFF by Schedule. Module operates according to predefined schedule and is currently off as scheduled.
3. OFF by DI. Module is off by opened state of PLC DI1.
4. OFF by Keypad. Module is off by Module En/Dis button.
5. OFF by Alarm. Module is locked out by one of the major alarms.
6. OFF by Primary. Module is switching between control states Primary / Secondary / Stand-alone.
7. OFF by System. Module is off by one of the System Off conditions.
8. Man Mode. Module is in manual mode.

Module Cntrl Status

Possible options:

1. Primary. Module acts as a primary module. Primary module performs temperature control for either heating or cooling loads. It also acts as a Supervisor when communicating with secondary modules and defines how many modules need to run its compressors in order to satisfy heating or cooling controlled temperatures.
2. Secondary. Module acts as a secondary module. Conditions for the module to be a secondary module:
 - a. Its PLC has been assigned IP address from secondaries addresses range
 - b. It's communicating with primary module
 - c. Primary module exists on the network, other words Primary PLC meets primary module conditions (see Primary Status below).
 - d. Stand-alone. Module doesn't meet either primary module or secondary module conditions.

Primary Status

Applies to primary PLC only. Possible options:



Operating Procedures

1. Primary ON. All primary modules conditions are satisfied by module.
2. Waiting ... All primary modules conditions are satisfied and module is counting down a delay before acquiring primary ON status.
3. OFF by Sensor. System cooling or heating temperature sensor failed.
4. OFF by no secondaries. Primary PLC communicates with no secondaries.
 - a. Primary Status states 3 or 4 will cause all the modules to run in Stand-alone mode. These failing conditions are false at normal primary/secondary operation.
 - b. Primary Online (Applies to secondary PLC only). LED is green - secondary PLC is communicating with primary PLC; LED is gray - secondary PLC is not communicating with primary PLC.

Lead Module

Indicates which module is currently a Lead Module in the chiller.

Evap / Cond Circuits

Displays both heat exchanger Evaporator and Condenser inlet and outlet temperatures as well as opening status of its Isolation Valves.

Control Temperature

Local module hot or chilled water temperature control sensor.

Temperature Setpoint

Local module heating or cooling temperature control setpoint. Can be adjusted by 'tech' user only.

Demand Compressors

Cooling or Heating Demand value in number of requested compressors.

Temp Cntrl Settings

Viewable / adjustable for 'tech' user only.

- Temp Diff +. Temperature control differential above setpoint or positive dead band (DB).
- Temp Diff -. Temperature control differential below setpoint or negative DB.
- Both of them define the temperature control DB.
- Temp Stage-Up Delay. When next compressor has been staged up, this delay has to elapse before next compressor is allowed to stage up.
- Temp Stage-Down Delay. When next compressor has been staged down, this delay has to elapse before next compressor is allowed to stage down.

On/Off Button

Used to turn secondary PLC module on / off in Stand-alone Mode. For primary PLC module, On / Off Button on the Home Screen serves the same purpose.

Overview Circuits

Refrigerant temperatures / pressures are displayed: suction pressure; discharge pressure; suction temperature; suction super heat temperature.

Liq Line Solenoid

Status of the solenoid valve installed on the liquid line pipe.

EX Valve

Indicates the position of electronic expansion valve, if installed.

Comp (X) En/Dis

Compressor enable / disable button.

Comp (X) Status

1. Comp OFF. Compressor is off and can't be turned on.
2. Ready. Compressor is off but can be turned on.
3. OFF by Cond Flow. Compressor has been called to run but waiting for Condenser Flow proof
4. OFF by Evap Flow. Compressor has been called to run but waiting for Evaporator Flow proof.
5. OFF by Min Off. Compressor is cycling through safety Minimum Off Time.
6. OFF by Switch. Compressor is off by En/Dis Switch.
7. OFF by Alarm. Compressor is off by Alarm.
8. Running. Compressor is running.
9. ON by Min On. Compressor has been called off although it keeps running due to safety Minimum On Time.
10. ON by Pumpdown. Compressor has been called off but keeps running due to Pump-down sequence.

Comp (X) Speed

Can be displayed in different units.

1. Volts. If PLC analog output is used to control variable speed compressor.
2. RPM. Compressor speed is communicated to external variable speed drive, for instance VFD.

Module I/O Screens

Data is collected by sensors as either analog or digital signals and displayed on the IO Status screens.

When the module screen is displayed, pressing the I/O button displays the I/O menu.

The I/O menu is comprised of two screens. Both primary and secondary modules have analog I/O (analog input and analog output), and digital I/O (digital input and digital output).



Table 5. The input/output screens

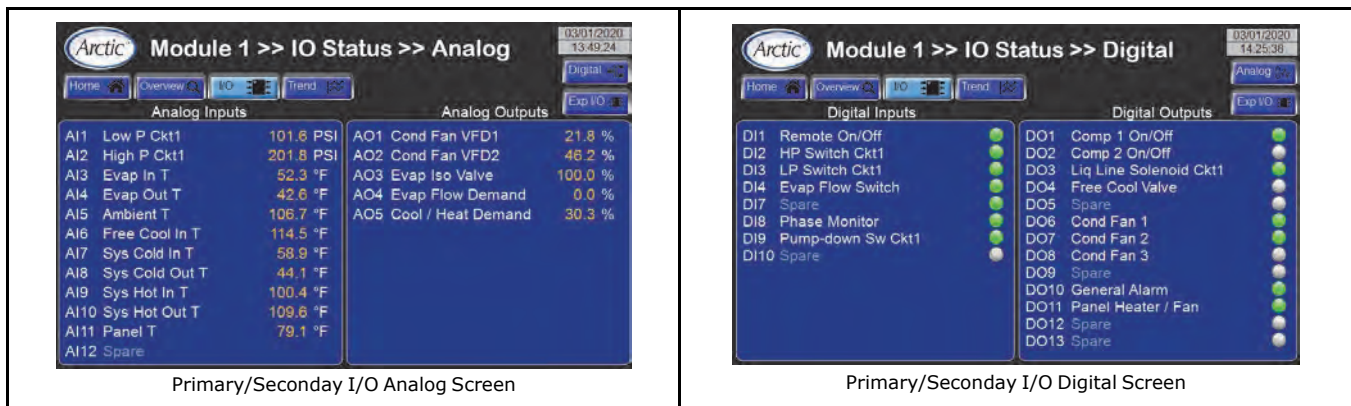

When an I/O screen is displayed, switching to other I/O screens is accomplished by pressing their respective buttons:

- The ANALOG button displays the analog screen.
- The DIGITAL button displays the digital screen.

Analog Inputs



Analog input (AI) data includes these parameters:

AI1

This input indicates suction pressure.

AI2

This input indicates discharge pressure.

AI3, AI4

These inputs indicate the evaporator inlet or outlet temperatures.

AI5, AI6

These inputs indicate the condenser inlet or outlet temperatures.

AI7, AI8

These inputs indicate the inlet or outlet chilled water temperatures. This applies to Cooling Mode.

AI9, AI10

These inputs indicate the inlet or outlet hot water temperatures. This applies to Heating Mode.

AI11

These inputs indicate the panel temperature (optional). This applies to Heating Mode. It is used when temperature control inside control panel is required either heating (for cold environment) or cooling (for hot environment).

Analog Outputs

Analog output (AO) data includes these parameters:

AO1

These outputs indicates condenser isolation valve position.

AO3

These outputs indicate the evaporator's isolation valve position.

AO4

These outputs indicate the evaporator's flow demand hard-wired signal for BAS.

AO5

These outputs indicate the variable speed compressor's hard-wired control signal.

Digital Inputs



Digital input (DI) data includes these parameters:

Digital LEDs



There is an LED for each digital input that indicates its current state. For all inputs, the color of the LED signifies its current state:

Green LED — This digital input is energized, the connected device is closed.

Gray LED — This digital input is de-energized, the connected device is open.

DI1 Remote On/Off

This activates a module on or off via digital input. If the primary digital on-off input is enabled, toggling the **DI1** on the primary module will turn the entire chiller/heater on or off.

DI2, DI3

These show the Discharge / Suction Pressure switches of Circuit 1. DI closed - pressure is in the normal range; DI opened - pressure is exceeding normal range threshold (faulty state).

DI4

These show the state of Evaporator flow switch. DI closed - flow present; DI opened - flow absent.

DI7

These show the state of Condenser flow switch. DI closed

- flow present; DI opened - flow absent

DI8 Phase Monitor

This is feedback for the three-phase power supply protection feature. If the digital input for this switch indicates closed, there are no power supply issues. If the digital input for this switch indicates open, a power supply failure has been detected.

If common power supply protection module is used for the chiller, its failure will affect each module. In such a case this DI is optional for secondary module.

DI9

This is the feedback for Pump-down pressure switch of Circuit 1. DI closed - pressure is in the normal range; DI opened - pressure is exceeding normal range threshold (faulty state).

Digital Outputs

There is an LED for each digital output which shows its current state.

Digital LEDs



There is an LED for each digital input that indicates its current state. For all inputs, the color of the LED signifies its current state:

Green LED — This digital output is energized, the connected device is powered up or running.

Gray LED — This digital output is de-energized, the connected device is not powered up or not running.

DO1, DO2 Comp On/Off

This digital output turns a compressor on and off.

DO3 Liq Line Solenoid

This digital output energizes and de-energizes the liquid line solenoid valve.

DO10 General Alarm

This digital output energizes when any of the following alarms occur:

- An alarm that shuts down and locks out compressor 1 or 2.
- An alarm that shuts down and locks out the entire module.

DO11 Panel Heater / Fan (optional)

This is the digital output is used when temperature control inside control panel is required (identical to A11).

Trend Screen



When on the primary module screen, pressing the trend button displays the trend screen. There are two trend screens: cooling trend screen and heating trend screen.

Module Trend Screen displays three trends: Controlled inlet / outlet water temperatures and Module Demand in %.

Trends can be viewed in real time as well as for the last seven days. Each variable is trended every three seconds. Trending data is stored on HMI internal memory.

Apart from displaying trends, Module Trend Screen has controls for viewing, scrolling, zooming, deleting trends etc.

Figure 18. Module trend screen



1. Trending variables instantaneous values according to cursor position. Current cursor timestamps are displayed as well.
2. Text box to select viewing time span. It's used for zooming in on trends time axis. Options for selection:
3. Maximum and Minimum thresholds for trends viewing. Used for zooming in on trends variables axis. Both Maximum and Minimum thresholds are adjustable via respective numeric boxes. Default Min / Max values: -10.0 / 160.0. 'Default Span' button is used to revert to defaults, so as to reset longitudinal zooming.
4. "Scroll to Time" button is used to return to real time viewing.
5. Cursor positioning buttons.
6. Buttons used to scroll back and forth in time. They implement time axis trends pages scrolling.
7. Buttons used to scroll back and forth in time. High resolution time axis scrolling.
8. Button is used to pause / resume real-time trending.

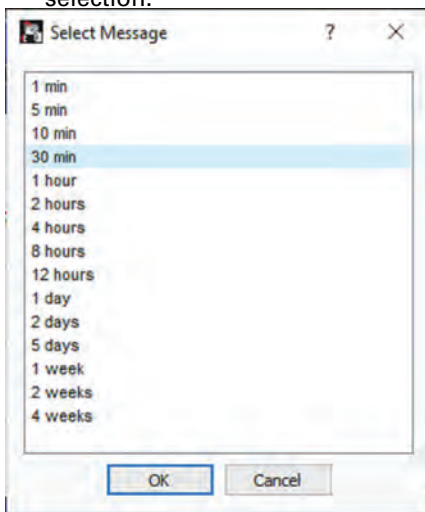

3. Maximum and Minimum thresholds for trends viewing. Used for zooming in on trends variables axis. Both Maximum and Minimum thresholds are adjustable via respective numeric boxes. Default Min / Max values: -10.0 / 160.0. 'Default Span' button is used to revert to defaults, so as to reset longitudinal zooming.

Operator Tasks

Before operating the unit, ensure that all compressor refrigeration service valves are fully back-seated counterclockwise.

NOTICE

Compressor Damage!

Failure to properly back-seat rotalock valves can cause compressor failure. Verify the circuit breakers on the module electrical panel are turned to OFF position prior to applying power.

Normal Power Up

The following procedure is used for a startup resulting from scheduled seasonal or programmed cold shut down of the chiller.

⚠ WARNING

Hazardous Voltage!

Failure to disconnect power before servicing could result in death or serious injury.

Disconnect all electric power, including remote disconnects before servicing. Follow proper lockout/tagout procedures to ensure the power can not be inadvertently energized. Verify that no power is present with a voltmeter.

Important: This start-up procedure is not to be used for the first-time initial startup for a newly installed chiller. See Preparation for Initial Startup in the Installation section of this manual for instructions regarding that situation.

1. De-energize the chiller using standard lockout/tagout procedures.
2. Using a known operational voltage meter, test and confirm the chiller is de-energized before proceeding further.
3. Inspect power distribution fuses and overload settings to verify they are correct.
4. Verify that the oil level is correct in each compressor using the compressor sight glass.

Note: See recommended inspection interval in the maintenance section of this manual.

NOTICE

Compressor Failure!

Failure to follow instructions below could result in catastrophic compressor failure.

Do not operate with insufficient oil.

5. Verify that pressure and temperature switches are closed.
6. Restore power to all modules.
7. Inspect refrigerant pressures for each module using the touchscreen interface panel.
8. Verify that pressure switches and thermostats have the correct cut-in and cut-out settings using the touchscreen interface panel.
9. Verify chiller water flow to condenser and evaporator.
10. Monitor and record temperature and refrigerant pressures registering on the touchscreen interface panel.

Emergency Power Shutdown

The chiller does not include a disconnect to turn off the high voltage to the modules. As per NFPA 70, The National Electrical Code, a disconnect must be installed within the line of sight of the electrical and control panel. Should an emergency condition arise, the

disconnect must be opened to shut down all voltage to the chiller.

There are several ways to interrupt power to all or part of the chiller:

- Disconnect the primary power source from the building that feeds electricity to the chiller. This occurs in sudden emergencies (usually weather-related) or planned maintenance shut-downs.
- Press the panel disconnect switch on the exterior door of the chiller's main power distribution panel, if so equipped.
- Move the circuit breaker switch to the OFF position (CB-1 and CB-2) on the power distribution panel. This cuts power to all of the chiller modules.
- Move the circuit breaker switch to the OFF position (CB-1 and CB-2) on a module's electrical and control panel. This cuts power to the compressors in a single module. It does not cut power to electrical and control panel or other chiller modules.
- Press the SYSTEM ON button on the touchscreen interface panel that is built into the power distribution panel door.

Note: Pressing the ON-OFF button on the touchscreen interface panel does not de-energize the chiller or the high voltage current into each module's electrical and control panel. This action sends a command to the controller in each module's compressors to discontinue electrical current to that component.

Water Quality Guidelines

The chiller is equipped with high efficiency compact brazed plate heat exchangers (BPHX). Water quality must be maintained periodically by the end user to avoid scaling and corrosion inside the heat exchangers.

Table 6. Water quality guidelines

Element /Compound/ Property	Value/Unit
pH	7.5 - 9.0
Conductivity	< 500 μ S/cm
Total Hardness	4.5 - 8.5 dH°
Free Chlorine	< 1.0 ppm
Ammonia (NH ₃)	< 0.5 ppm
Sulphate (SO ₄ ²⁻)	< 100 ppm
Hydrogen Carbonate (HCO ₃₋)	60 - 200 ppm
(HCO ₃₋) / (SO ₄ ²⁻)	> 1.5
(Ca + Mg) / (HCO ₃₋)	> 0.5

Table 6. Water quality guidelines (continued)

Element /Compound/ Property	Value/Unit
Chloride (Cl-)	< 200 ppm

Notes:

1. Total Hardness/corrosion: Water with high hardness can cause corrosion problems due to its high ion content (Ca+2, Mg+2, Fe+2) which also means a high electrical conductivity and a high total dissolved solid (TDS). For this reason, too high hardness values should be avoided, not only due to higher risk of scaling, but also for corrosion risk. On the other hand, soft water, but not necessarily cation exchange softened water, may in contrast have a low buffering capacity and so be more corrosive. If the hardness values are outside the recommended range, other parameters such as oxygen content, conductivity, and pH values should be considered to evaluate the corrosion risk
2. Fe3+ and Mn4+ are strong oxidants and may increase the risk for localized corrosion on stainless steels in combination with brazing material copper.

Monitor Water Quality

Maintaining water/glycol mixture quality and cleanliness is critical to chiller health and maintainability. Strainers should be checked and cleaned on a regular basis. Water/glycol mixture samples should be taken and tested by a professional

lab. The results will enable the accurate adjustment of quality thereby increasing the operational life of the chiller.

Note: Trane will not validate the chiller warranty if the proper water/glycol mixture composition and quality is not maintained.

Protect the chiller from freezing, particularly if the chiller has a set point that is lower than the freezing point of the water/glycol mixture in the chiller. The chiller is designed to operate with a maximum propylene glycol concentration of 50%. See [Table 7, p. 37](#), for the effects on the chiller when operating with other glycol concentrations.

[Table 7, p. 37](#) shows the capacity reduction and the pressure drop that occurs when higher concentrations of glycol are used.

Maintain Glycol Level

When the chiller has a water set point that is below the freezing point of the water/glycol in use, take precautions against freezing.

The glycol concentration should be based on the lowest fluid design temperature. See [Table 8, p. 38](#), provides guidelines for adding propylene glycol.

Table 7. Glycol performance impact factors

Range Factor	Glycol Concentration Percentages and Performance Impact					
	30%		40%		50%	
Propylene Glycol Concentration	30%		40%		50%	
Lowest Ambient Temperature	10 °F (-12 °C)		-4 °F (-10 °C)		-20 °F (-29 °C)	
Recommended Minimum Leaving Fluid Temperature	25 °F (-4 °C)		10 °F (-12 °C)		-10 °F (-23 °C)	
Leaving Temperature	Capacity Reduction Factor	Pressure Drop Factor	Capacity Reduction Factor	Pressure Drop Factor	Capacity Reduction Factor	Pressure Drop Factor
70 °F (21 °C)	0.96	1.27	0.93	1.43	0.91	1.63
60 °F (15.6 °C)	0.95	1.31	0.92	1.47	0.90	1.68
55 °F (13 °C)	0.95	1.31	0.92	1.50	0.89	1.73
50 °F (10 °C)	0.94	1.33	0.91	1.51	0.88	1.75

A 10% to 50% solution of glycol should be added to prevent pipe corrosion regardless of the fluid temperature. Propylene glycol has corrosion inhibitors that protect piping and components from corrosion and buildup of rust and other deposits. Trane recommends against using water/glycol solution in excess of 50% regardless of the ambient temperature conditions.

NOTICE

Equipment Damage!

Failure to follow instructions below could result in permanent damage to pump and internal cooling surfaces.

Do not use automotive antifreeze.

Note: If glycol-free solutions are mandated at the chiller site, special inhibitors are available for rust prevention, mineral deposit inhibition, and biological suppression. Adding these inhibitors to the water solution is strongly recommended.



Operating Procedures

Heaters, heat tracing cable, and closed cell insulation can be installed on any exposed “wet” chiller components and tank and pump modules for protection against freezing in low ambient temperature and low refrigerant pressure conditions. However, the best freeze prevention is using the appropriate concentration of glycol. Trane does not warrant any component that fails due to freezing.

Prevent Freezing

Many liquids expand in volume upon cooling. This expansion may cause pipes and other enclosed systems containing a liquid to rupture or burst when exposed to low temperature conditions. Burst protection is needed to protect piping and other enclosed systems when they are inactive as they could rupture due to expansion during cold weather or low refrigerant pressure.

Freeze points and burst points of glycol-water solutions are shown in [Table 8, p. 38](#).

In order to maintain a high quality glycol solution, the water used in the glycol mixture must have very few impurities. Impurities in the water can increase metal corrosion, aggravate pitting of cast iron and steel, reduce the effectiveness of the corrosion inhibitors, and increase the depletion rate of the inhibitor package.

To assure inhibitor effectiveness, the levels of chlorides and sulfates in the water should not exceed 25 ppm each. The total hardness in terms of calcium carbonate should be less than 100 ppm. For best long-term results, de-ionized or distilled water is recommended. Trane can provide concentrated solutions of Dowfrost, propylene glycol, or premixed solutions for use with the chiller.

NOTICE

Equipment Damage!

Failure to follow instructions below could result in permanent damage to pump and internal cooling surfaces.

Do not use automotive antifreeze.

Propylene Glycol

Glycol-based fluids provide such burst protection in water solutions due to their low freezing points. As a glycol-based fluid cools below the solution’s freezing point, ice crystals begin to form, and the remaining solution becomes more concentrated in glycol. This ice/water/glycol mixture results in a flowable slush, and remains fluid, even as the temperature continues to cool.

The fluid volume increases as this slush forms and the temperature cools, flowing into available expansion volume in the chiller. If the concentration of glycol is sufficient, no damage to the chiller from fluid expansion should occur within the temperature range

indicated in [Figure 19, p. 39](#). When liquids are cooled they eventually either crystallize like ice or become increasingly viscous until they fail to flow and set up like glass. The first type of behavior represents true freezing. The second is known as super-cooling. Glycols do not have sharp freezing points. Under normal conditions, propylene glycol sets to a glass-like solid, rather than freezing.

The addition of glycol to water yields a solution with a freezing point below that of water. This has led to the extensive use of glycol-water solutions as cooling media at temperatures appreciably below the freezing point of water. Instead of having sharp freezing points, glycol-water solutions become slushy during freezing. As the temperature falls, the slush becomes more and more viscous and finally fails to flow.

Table 8. Freeze and burst protection chart

Water/Glycol Temperature	Freeze Protection	Burst Protection
20 °F (-7 °C)	18% glycol mixture	12% glycol mixture
10 °F (-12 °C)	29% glycol mixture	20% glycol mixture
0 °F (-17.8 °C)	36% glycol mixture	24% glycol mixture
-10 °F (-23 °C)	42% glycol mixture	28% glycol mixture
-20 °F (-29 °C)	46% glycol mixture	30% glycol mixture

The precise concentration of glycol for a particular chiller is affected by several key factors such as ambient temperature extremes, entering and leaving water temperatures, and chiller size. A chiller’s optimum glycol concentration is modified by these considerations as reflected in [Table 7, p. 37](#). These capacity correction factors are the “best informed estimates” for chillers with copper evaporators. The percentages may vary depending on the materials and alloys of the heat exchangers, total surface area, the amount of present or future fouling, and the brand of glycol used.

The calculations in this table are most accurate for Dowfrost (propylene glycol) and Dowtherm (ethylene glycol) branded products. Consult your local supplier or engineering contractor for more precise recommendations.

Storage Provisions

The chiller controls are designed for storage in ambient temperatures from -20 °F (-29 °C) to 145 °F (63 °C) with relative humidity from 0% to 100%. The glycol should be removed from the chiller if the unit is to be stored for extended periods. Although fluids can be drained via the plug in the bottom of the evaporator, the inhibitors in an approved glycol solution will best protect the surfaces of the evaporator against oxidation if the glycol remains inside the chiller during storage.

Figure 19. Water/Glycol concentration freezing points (in degrees fahrenheit)

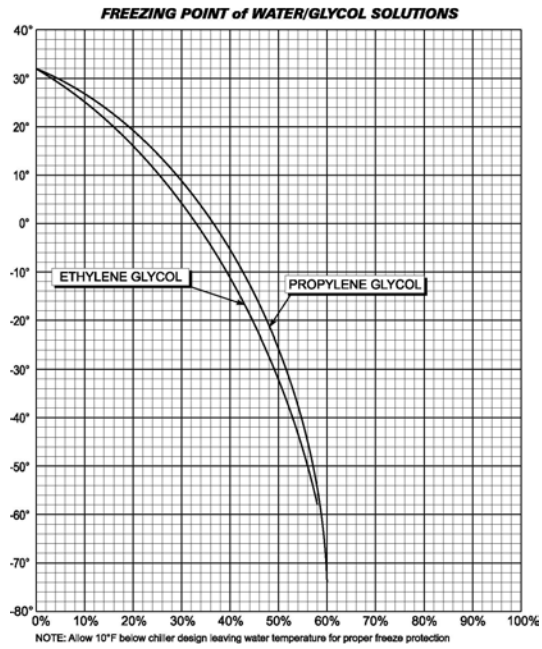



Controls Interface

Microprocessor Control System

SuperMod™ Chiller models employ a Carel c.pCO all-digital data control system to control and report key system settings and indicators.

Primary Microprocessor Controller

Both the primary and secondary modules use a Carel c.pCO medium microprocessor controller. The primary microprocessor controller rotates the lead compressors every 168 system operating hours. See below figure.

Figure 20. c.pCO primary controller



Secondary Microprocessor Controller

In a normal configuration, a secondary controller controls the single module to which it is dedicated. The distributed primary microprocessor controller system enables the chiller to operate in the event the primary microprocessor controller fails. The system automatically fails-over to distributed primary control where each secondary controller operates its own module but lacks the ability to rotate the lead compressors every 168 system operating hours.

Touchscreen Interface Panel

The touchscreen interface panel is the primary means for controlling and monitoring the system for the operator and maintainer. See the following figure.

Figure 21. Touch interface panel



Operator Control and Monitoring

Each system is provided with a touchscreen interface panel that is used to turn the chiller on and off, adjust set points, clear alarms, and perform detailed set-up of the microprocessor controllers.

Chiller Control

The operator uses three different types of controls and indicators to monitor and maintain the desired operating parameters in the SuperMod™ Chiller. These controls and indicators are located in the power panels and the microprocessor controllers.

Power Distribution

There are two different electrical panels used in the SuperMod™ Chiller. The main power distribution panel receives power from the building source and distributes it to the individual chiller modules. The module electrical and control panel receives power from the power distribution panel and provides power to individual electrical components.

⚠ WARNING

Hazardous Voltage!
 Failure to disconnect power before servicing could result in death or serious injury.
 Disconnect all electric power, including remote disconnects before servicing. Follow proper lockout/tagout procedures to ensure the power can not be inadvertently energized. Verify that no power is present with a voltmeter.

Main Power Distribution

The power distribution panel distributes electricity from the external building power supply. It also houses breakers, phase monitor, and a built-in interface panel (and, potentially, an optional door-mounted primary power disconnect switch). See below figure.

Figure 22. Power distribution panel

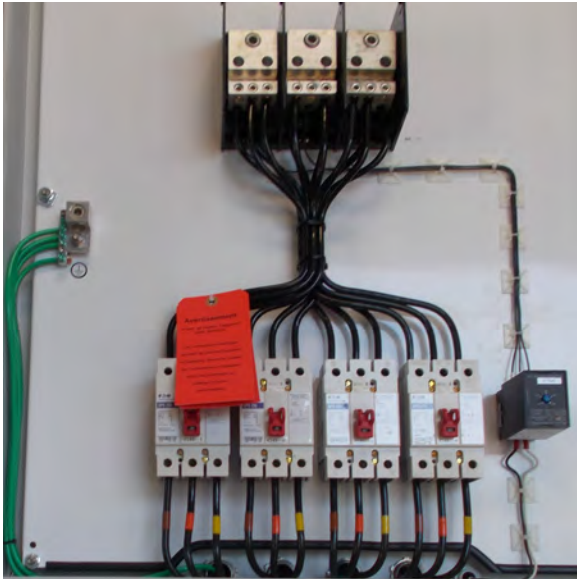

Panel Disconnect

Some SuperMod™ Chiller systems are optionally equipped with a panel-mounted disconnect switch installed on the outside of the power distribution panel (or on each module's electrical and control panel if the chiller has power supplied directly to each individual module). The disconnect switch must be turned to the OFF position before the panel can be opened for service.

Module Electrical and Control Panel

From the power distribution panel, power is fed to the individual chiller modules and connects to each module's electrical and control panel. See the following figure.

Electrical Controls

The SuperMod™ Chiller is provided with controls and indicators to monitor the electrical activity and notify operators if problems arise.

Figure 23. Module electrical and control panel

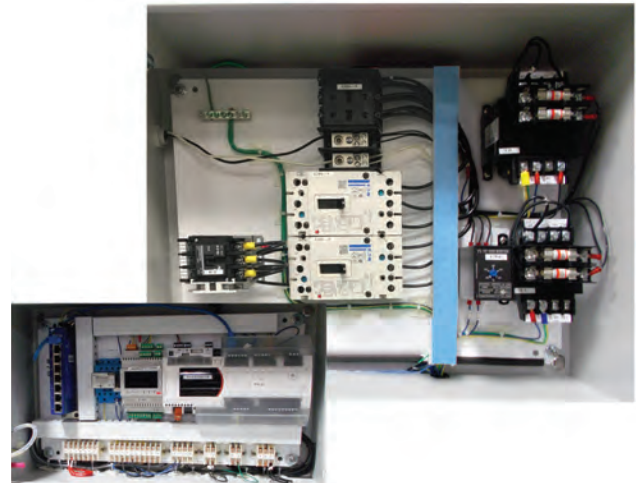

Flow Switch

A flow switch is wired into the low voltage control circuitry used to detect the flow of liquid throughout the hydronic system. Flow switches are found on all evaporators with isolation valves. Flow switches close when flow is detected allowing compressors to start. If there is no flow, compressors cannot operate.

After every chiller power-on, all LEDs on the flow switch illuminate and go out again in sequence. The switch is ready for operation when an amber LED is visible on the switch display:



NOTICE

Proof of Flow Switch!

Failure to provide flow switches or jumping-out of switches could result in severe equipment damage.

Evaporator and condenser water circuits require proof of flow switches.

- Failure to include the proof of flow devices and/or jumping out these devices could cause the unit to stop on a secondary level of protection.
- Frequent cycling on these higher level diagnostic devices could cause excessive thermal and pressure cycling of unit components (O-rings, gaskets, sensors, motors, controls, etc.) and/or freeze damage, resulting in premature failure of the chiller.

Phase Monitor

A compressor can fail if operated in reverse for more than a minute. A phase monitor is used on three phase power systems to ensure that the electricity supplying the chiller is configured appropriately. A phase monitor prevents a motor from operating in reverse—if any of the three legs of power are landed incorrectly—and will shut the system down upon detection of a reversed phase condition.



Refrigeration Controls

Controls on the refrigeration system are designed to provide safety for the major components and for proper operation of the system.

Pressure transducers convert pressure into an electronic signal that the microprocessor displays in pounds per square inch (psi). Transducers vary in pressure ranges that depend on the type of refrigerant used. Pressure transducers are calibrated using the interface panel.

Temperature sensors transmit temperature data electronically to the microprocessor for display in either Fahrenheit (°F) or Celsius (°C). Temperature sensors are calibrated using the interface panel.

Electronic Expansion Valve

An expansion valve is a metering device controlling the flow of refrigerant to the evaporator based on evaporator superheat. The electronic expansion valve is designed to act as the expansion device for the SuperMod™ Chiller. Incorporated sight glass monitors movement of the movable element and refrigerant flow inside the system. The valve is made from modular elements assembled during installation, to simplify maintenance and inspection of the components.

Superheat is factory-set for around 12 °F (-11 °C). Close the valve to increase superheat. To accurately read superheat, install a temperature sensor at the evaporator outlet. The sensor bulb should be located at

the 4 o'clock or 8 o'clock positions on the pipe for the most accurate pressure measurement.

Ensure that the closed cell insulation covers the thermal expansion valve sensing bulb. If insulation is missing, the bulb will tend to feed more refrigerant to satisfy the superheat setting.



Sight Glass

When the sight glass shows a green indicator, no moisture is present. When the sight glass shows a yellow indicator, there is moisture in the refrigerant line. Bubbles can be observed whenever chiller cycling causes the pressure to change up or down.

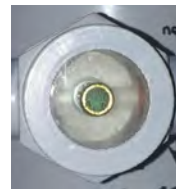

NOTICE

Equipment Damage!

Failure to remove moisture from system could cause corrosion within the chiller/heater components, and degrade performance. Perform vacuum evacuation of system to remove moisture.

Low Pressure Bypass

Logic that uses a time delay that temporarily bypasses the low-pressure switch for compressor start up. Once the delay times out the normal controls are put back on line within the control circuit.

Thermal Capacity

The thermal capacity of the chiller modules is dependent on the leaving temperature of the chilled water/glycol mixture, maintaining a minimum flow of water through the evaporator and keeping debris out of the air-cooled condenser. In applications where it is desired to operate with a lower flow rate or higher temperature change, consult the technical support for recommendations.



Sequence of Operations

This manual describes a typical water-cooled chiller system with few, if any, optional components or devices attached. To cover the primary difference in construction and operation, two sequences of operation are included; one for a constant flow chiller system and the other for a variable flow chiller system.

Variable Flow Sequence

1. The chiller is designed to operate with high voltage power supplied to the unit at all times.
2. As long as there is power on the system, the electronic valve in the primary module will open to allow flow through the entire chiller system.
3. The chiller system is enabled when the system on-off switch on the touchscreen interface panel is energized, and the remote start/stop relay is enabled either through a contact closure or via the BMS.
4. When the system is enabled, the chiller pump (if provided by Trane) will energize. If the differential pressure switch within the tank and pump module closes within the time delay period, the primary pump continues to operate. Should the primary pump fail to start or close the differential pressure switch within the time delay period, this pump will de-energize, and the secondary pump will activate. An alarm signal is generated providing an indication of primary pump failure on the microprocessor controller.
5. The variable frequency drive (VFD) for the chiller pumps are provided and installed by Trane. The control signal for each VFD is provided from the microprocessor in the tank and pump module. The pump speed is synchronized with the number of chillers that are operating on the system.
6. The electronic isolation valve of the primary lead chiller identified in step 2 is already energized. Therefore, the system pump must produce the minimum flow required by the lead chiller. A system bypass must be provided by the customer and installed external of the chiller to assure that the pump can provide the minimum flow required through the lead chiller. (A high-quality pressure-independent valve is recommended for this bypass to provide accurate bypass control regardless of the system pressure differential between the supply and return headers.)
7. Once this minimum flow is established and the system demand (based on leaving water/glycol temperature) indicates that there is a requirement for cooling, the lead compressor of the lead module will energize provided all safeties of that refrigeration circuit are satisfied.
8. Once there is a system load, the building management system will modulate the system bypass decreasing the bypass flow, as the flow rate through the fan coils increases. This control is provided by the customer external of the chiller but is presumed to be based on the temperature of the water back to the chiller or the pressure differential across the most remote fan coil unit if it has a three-way valve.
9. As the system demand continues to increase, the second compressor within that module will energize provided all safeties on that circuit are satisfied.
10. As the system demand continues to increase, the leaving water/glycol mixture temperature from the chiller system will slowly increase until the differential set point is reached. When the differential is reached, a second module is brought on-line. The pump VFD control must be set to ramp up quickly to provide adequate water flow to both operating modules and eliminate nuisance alarms such as low flow and low pressure if there is not sufficient flow to the operating modules.
11. As the flow and demand continue to increase, and the temperature once again reaches the set point plus differential setting, the second compressor on the second module will energize. This operation continues with all subsequent chiller modules as needed based on system demand.
12. On a decrease in system demand (and flow) such that the leaving water/glycol mixture temperature reaches the set point minus the differential, a compressor will de-energize. Once both operating compressors within an operating module have de-energized, the modulating valve will slowly close off flow to that module. It is critical that the corresponding pump variable frequency driver controller slowly ramp down the speed of the pump to the next operating point so as not to limit flow to the operating chillers as the valve time to close is approximately 150 seconds.
13. This process occurs throughout the operating range of the chiller system. At all "in-between" stages of system capacity and demand balancing, the digital scroll compressor on the primary module will modulate its capacity within the temperature control band limits to maintain the leaving water temperature control as tight as possible and to minimize the amount of compressor cycling.
14. Should the primary microprocessor fail, the balance of the modules will continue to operate in response to demand. If the chiller system is provided with a redundant primary microprocessor on a secondary chiller module, all functions of the primary microprocessor are transferred to the redundant



Sequence of Operations

primary microprocessor should the primary microprocessor fail.

15. The microprocessor control system in each chiller module will close the electronic isolation valve within that chiller module if there are alarms on

both refrigeration circuits within that module to prevent flow from flowing through a non-active module which causes an increase in the system flow and an unnecessary increase in the number of chiller modules to maintain the system set point.



Chiller Performance Data

This manual uses a typical 120-ton water-cooled chiller consisting of four modules with brazed plate evaporators for example purposes. The model number

and a chiller's precise electrical and refrigerant data can be found on the chiller model nameplate. See "Model Number and Coding," p. 7.

Table 9. Typical SuperMod™ water-cooled chiller specification for example purposes

Chiller System (four 30-ton water-cooled chiller modules) Model # TPWCCMV0300T4-MM-VS			
Evaporator Type	Brazed plate	Condenser Type	Brazed plate
Evaporator Flow	292 gpm	Condenser flow	352 gpm
Evaporator Fluid	Water	Condenser fluid	Water
Entering Fluid Temperature	54 °F (12 °C)	Entering Fluid Temperature	85 °F (29 °C)
Leaving Fluid Temperature	44 °F (7 °C)	Leaving Fluid Temperature	95 °F (37.3 °C)
Evaporator Pressure Drop	3.7 psi	Condenser Pressure Drop	6.7 psi
Maximum Operating Pressure	650 psi (refrigerant side)	System Capacity	1,503,500 btu/hr. (120 tons)
Refrigerant	R410A	Connections	6 in. roll grooved
Chiller Modules (4)			
Compressors	Two per module	Rated Load Amps	17.1 amps each
Horsepower	15	Total Full Load Amps	34.2 amps per module
Locked Rotor Amps	173 amps	Electrical Power Supply	460/60/3
System			
Total Full Load Amps	136.8 amps	Maximum Overcurrent Capacity	175 amps
Minimum Circuit Ampacity	141.0 amps		
Dimensions			
Each Chiller Module	24 W x 66 L x 77 H in. ^(a)	Overall Chiller System	96 W x 66 L x 77 H in. ^(b)
Weight			
Each Chiller Module	1,600 lbs.	Overall Chiller System	6,400 lbs.

^(a) Primary module is 32 in. wide, including power distribution panel.

^(b) Including power distribution panel and end louvers.

Maintenance Procedures

Maintenance Strategy

The primary goal of preventive maintenance is to avoid the consequences of failure of equipment. This may be by preventing the failure before it actually occurs which preventive maintenance helps to achieve. It is designed to preserve and restore equipment reliability by replacing worn components before they actually fail. In addition, operators can record equipment operating conditions, temperatures, and pressures so they know to replace or repair worn parts before they cause chiller failure. The ideal maintenance program predicts and prevents unnecessary and costly repairs and chiller down time. Trane chillers are designed for ease of access with a premium placed on locating key components to facilitate visual inspection and hands-on verification.

One approach to chiller maintenance envisions three levels of maintenance effort reflecting frequent, periodic, and scheduled maintenance tasks, with each

level building on the previous level. A daily or weekly “health check” involves habitual visual and manual inspections of the components of the chiller so that anomalies become evident when they occur. Weekly or monthly periodic maintenance involves cleaning specific components and inspecting glycol and lubrication fluids. Finally, since all components will eventually wear out, a prudent maintenance strategy will anticipate and schedule replacement or rebuilding of critical components before they fail and require emergency response to keep chillers operational. See below figure.

Maintenance for HVAC equipment and facilities can include a “preventive maintenance checklist” which includes small checks which can significantly extend service life. Other considerations such as weather and equipment age are taken into account; maintenance and equipment replacement is often performed before the hottest time of the year.

Figure 24. An approach to chiller maintenance

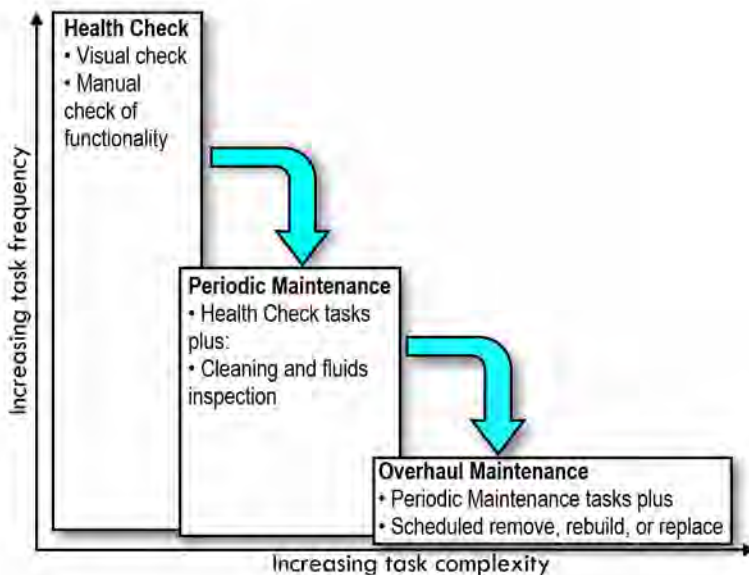

Power Disconnect Switch

Some SuperMod™ Chiller units are optionally equipped with a panel-mounted disconnect switch installed on the outside of the power distribution panel (or on each module’s electrical and control panel if the chiller has power supplied to each individual module). The disconnect switch must be turned to the off position before the panel can be opened for service. When the panel door is open, power can be reconnected by turning the handle located on the inside of the panel to the ON position.

⚠ WARNING

PPE for Arc/Flash Required!

Failure to wear appropriate PPE could result in death or serious injury.

On this unit, if the handle shield is cracked the circuit breaker could arc/flash when reset. To avoid being injured, technicians **MUST** put on all necessary Personal Protective Equipment (PPE), in accordance with NFPA70E for arc/flash protection, **PRIOR** to entering the starter panel cabinet.

NOTICE

Component Damage!

Failure to follow instructions could damage sensitive electronic components beyond repair. To prevent arcing or surges of electrical current, do not use wires or cables to jump components or bypass the manufacturer's safety systems.

Federal Clean Air Act

Responsible refrigerant practices are important to the environment, our customers, and the air conditioning industry. All technicians who handle refrigerants must be properly certified. The Federal Clean Air Act prescribes procedures for handling, reclaiming, recovering, and recycling of refrigerants and the equipment that must be used in maintenance procedures involving potential leakage of HVAC refrigerants. State and local governments may have

additional requirements that must be followed to responsibly handle HVAC refrigerants.

Inspection and Maintenance Schedule

Proactive measures should be taken to prevent potential problems with the chillers. These include maintaining a operational log and conducting weekly, quarterly, and annual inspections of the chiller. See following table.

Daily

A daily visual inspection can reveal obvious problems. Keep notes of the chiller performance:

- Log pressures and temperatures.
- Visually inspect of the unit.

Table 10. Recommended chiller service intervals

Task	Frequency
Visually inspect the chiller	Daily
Log pressure and temperatures	Daily
Inspect touchscreen interface panel for alarm history	Weekly
Clean strainers on the inlet water pipe	Monthly
Check the compressor oil level sight glass	Monthly
Confirm the glycol concentration	Monthly
Confirm the refrigeration pressures	Monthly
Check the refrigeration liquid line sight glass	Monthly
Inspect refrigerant pressures and temperature set points	Quarterly
Inspect superheat (10 °F to 12 °F [5°C to 6°C]) and sub-cooling temperatures (10°F to 15°F [5°C to 8°C])	Quarterly
Inspect the evaporator entering and leaving evaporator temperature	Quarterly
Collect water/glycol mixture sample for analysis	Quarterly
Inspect crankcase heaters	Quarterly
Inspect piping for signs of leaks	Quarterly
Inspect refrigerant piping for oil or refrigerant leaks	Quarterly
Observe refrigeration operating pressures	Quarterly
Confirm motor amperage draw and voltage	Quarterly
Confirm chiller superheat and sub-cooling	Quarterly
Check for worn or burned contactors	Quarterly
Inspect all electrical connections and fuses	Annually
Inspect each compressor for refrigerant pressures, overheating, oil leaks	Annually
Inspect compressor terminals for pitting, corrosion, and loose connections	Annually
Inspect compressor oil level	Annually



Maintenance Procedures

Table 10. Recommended chiller service intervals (continued)

Task	Frequency
Confirm and record compressor amperage draw and voltage	Annually
Compare water/glycol flow against design specifications	Annually
Tighten compressor rotalock nuts	Annually

Weekly

Weekly inspection is a continuation and elaboration of daily best practice:

- Inspect touchscreen interface panel for alarm status and additions to the alarm history. (Do not clear alarms as this is a very important performance record if troubleshooting problems occur.)
- Listen for excessive vibrations or motor noise. This usually signals a loose brace or section of piping.
- Measure all refrigerant static pressure on any idle circuits. Record any significant changes or reductions in pressure.
- Clean strainers weekly during initial weeks after initial start up until water quality has been reliably established. Thereafter, inspect and clean strainers at least monthly .

Monthly

The monthly maintenance inspection examines many items that generally require frequent attention. This routine event identifies small problems early before they can become big problems requiring serious repair and refurbishment:

1. Remove the strainer on the inlet water pipe to the chiller and verify that it is clean and free of debris.
2. Clean the strainer’s mesh screen by back-washing with high water velocity. If fine particles cannot be removed with the water stream, use a mild detergent and a non-abrasive brush to remove them.
3. Check the compressor oil level sight glass. The oil should always be clear and free-flowing. Any milky or “slow rolling” effect indicates that liquid refrigerant is making its way back into the compressor and will cause premature compressor failure.

NOTICE

Equipment Damage!

Failure to remove moisture from system could cause corrosion within the chiller/heater components, and degrade performance. Perform vacuum evacuation of system to remove moisture.

4. When the compressor is not operating, the oil level should be at least at the bottom of the sight glass, up to two-thirds full. When the compressor is

operating, the oil level will normally be at the bottom of the sight glass, or even below, but it must be visible.

NOTICE

Compressor Failure!

Failure to follow instructions below could result in catastrophic compressor failure.

Do not operate with insufficient oil.

5. Low oil sight glass conditions could signify a short cycling, an oil leak, or an undercharged chiller that lacks proper refrigerant velocity to return oil to the compressor sump. Eventually, dry compressor starts could occur causing premature compressor failure. This may indicate that some oil has been lost from a previous refrigerant leak repair. The compressor data label indicates the correct oil type and quantity with which it should be filled.

Note: A flashlight may be required to see the oil churning in the sump of the compressor. Adjusting the line of sight may be necessary to visually inspect the oil in the compressor sump during operation. At a minimum, the oil must be seen churning in the compressor sump. It should be clear.

NOTICE

Compressor Failure!

Failure to follow instructions below could result in catastrophic compressor failure.

Do not operate with insufficient oil.

6. Check the glycol concentration using a refractometer.
7. Check the refrigeration pressures. For R410A refrigerant, low pressure refrigeration gauge should read 120 to 160 psi and high pressure refrigeration gauge should read 300 to 450 psi.

NOTICE

Compressor Damage!

Failure to follow instructions below could result in extensive compressor damage.

Verify that suction pressure is sufficient. Secure the circuit or module offline until status can be examined in detail.

8. Check the refrigeration liquid line sight glass for persistent bubbles (“flashing”) .

Note: Bubbles in the sight glass do not necessarily indicate loss or lack of refrigerant charge. Bubbles (commonly known as “flashing”) will occur whenever the condenser fans cycle until the expansion valve settles out the refrigerant flow. Occasional bubbles also form when the condenser head pressure control valve bypasses hot gas around the condenser coil in low ambient operation. If the refrigeration pressures are in the normal range, the unit is most likely adequately charged. “Flashing” could also indicate excessive superheat adjustment of the thermal expansion valve.

Quarterly

The quarterly maintenance inspection is a comprehensive event that examines all aspects of the chiller to identify early problems before they can damage a chiller and require major repair or refurbishment:

1. Inspect alarm log, refrigerant operating/static pressures and temperature set points of each module independently.
2. Inspect chiller superheat and sub-cooling. System superheat should be 10 °F to 12 °F (5 °C to 6 °C). System sub-cooling should be 10+ °F (5 °C) depending on the ambient conditions.
3. Inspect the approach delta T - entering evaporator water/glycol mixture temperature and leaving refrigerant temperature.
4. Inspect strainers. Ensure bypass valve is properly adjusted to a minimum of 25% open position.
5. Collect chilled water/glycol mixture sample for professional analysis. Check for cleanliness. Drain and refill with clean solution if excessive sludge or dirt is present. Flush the chiller prior to refilling.
6. Inspect water/glycol mixture levels. Add glycol as required.
7. If equipped, inspect crankcase heaters for proper operation.
8. Inspect the water piping for signs of leaks at joints and fittings.
9. Inspect refrigerant piping circuit for signs of oil or refrigerant leakage. Conduct “sniffer test” to find refrigerant leaks. Inspect all pressure switch bellows.
10. Tighten all refrigeration piping connections (e.g. rotalocks, Schrader valves, caps, and ball valves).
11. Install a manifold and gauge set to observe chiller’s refrigeration operating pressures.
 - a. Verify that the pressure controls (low pressure and high pressure switches) are “cutting in” and “cutting out” at the appropriate pressures.
 - b. Verify refrigerant charge by recording the superheat and sub-cooling temperatures.
- c. Observe head pressure for signs of improper condensing from clogged strainers, or a modulating expansion valve issue.

12. Check compressor motor amperage draws and voltage supplies and maintain a record of those values. Verify that they are within the name plate rating. Also, check for voltage imbalance. The chiller’s phase monitor will open if the voltage imbalance exceeds 4%.

13. Check for chattering, excessive wear or burned contacts on motor starters. Replace contacts, if in doubt. It is recommended to replace contactors every 5-6 years.

Annually

The annual chiller maintenance inspection is critical to the long-term performance of the chiller. Whether a chiller has a service life of 15 years or 30 years is almost entirely dependent upon how consistently and how diligently the annual maintenance inspection and tasks are performed. The annual event is a comprehensive inspection that examines all aspect of the chiller to identify and repair small problems before they can become major issues that damage a chiller and require significant repair or refurbishment.

1. Inspect all electrical connections for damage and ensure terminals are tight. Inspect all contactors for pitting and corrosion and replace as necessary. It is recommended to replace contactors every 5-6 years.

⚠ WARNING

Hazardous Voltage!

Failure to disconnect power before servicing could result in death or serious injury.

Disconnect all electric power, including remote disconnects before servicing. Follow proper lockout/tagout procedures to ensure the power can not be inadvertently energized. Verify that no power is present with a voltmeter.

2. Inspect fuses to ensure they are secure, of correct amperage rating, undamaged and functioning.
3. Energize each compressor and check refrigerant pressures, signs of overheating, and oil leaks. Check for noises and for leaks with an electronic or bubble leak detector. Inspect flared fittings, refrigeration gauges, compressor connections, braze joints, pressure switches, and access ports on Schrader valves.

⚠ WARNING**Refrigerant under High Pressure!**

Failure to follow instructions below could result in an explosion which could result in death or serious injury or equipment damage.

System contains refrigerant under high pressure. Recover refrigerant to relieve pressure before opening the system. See unit nameplate for refrigerant type. Do not use non-approved refrigerants, refrigerant substitutes, or refrigerant additives.

4. De-energize each compressor and inspect terminals for pitting, corrosion, and loose connections.
5. Inspect that the oil level is visible in each compressor and not discolored. Annual oil samples should be taken to be analyzed for destructive acids, corrosive materials, or metal deposits.
6. Inspect and record the compressor amperage draws and voltage.
7. Record water/glycol mixture flow to ensure it meets design specifications.
8. Inspect all copper lines and control capillary tubing to ensure that the lines are separated and not vibrating against one another or the frame or housing.
9. Ensure all refrigeration lines are properly supported to prevent vibration from causing premature failure of copper piping.
10. Inspect all insulation on piping and control sensors. Repair and replace as necessary.
11. Inspect entire plumbing system for leaks.
12. Review logged alarms and look for repetitive trends. The chiller's PLC can retain the previous 200 alarms with time and date of occurrence.
13. If equipped, inspect crankcase heaters to verify proper operation.
14. Sample refrigerant to analyze for moisture or acid.
15. Inspect operating pressures and temperatures and ensure the chiller has a full refrigerant charge.

Maintenance Tasks

The maintenance tasks described herein present the basic, minimal, steps required to successfully complete a task. Local policies and protocols may require more elaborate procedures with additional checks and inspections.

Inspection Methods

Appropriate inspection for modern chillers can be described as "hands on." Where possible and appropriate, visual inspection should include touching the component or apparatus being inspected. The sense of touch provides additional feedback regarding

temperature, texture, tightness, and dryness that "eyes only" inspection cannot match. Habitually touching each item to be inspected also ensures that items are not subconsciously skipped during the inspection process. For a summary of tasks, see , Recommended Chiller Service Intervals.

⚠ WARNING**Hazardous Voltage!**

Failure to disconnect power before servicing could result in death or serious injury.

Disconnect all electric power, including remote disconnects before servicing. Follow proper lockout/tagout procedures to ensure the power can not be inadvertently energized. Verify that no power is present with a voltmeter.

Critical Cleaning Tasks

Monitor temperature change and pressure drops across the evaporator and condenser circuit to determine the frequency for strainer cleaning. Monitor water quality in the chiller's closed system to determine the optimum frequency for evaporator cleaning.

On multiple module chillers, Trane provides service isolation valves on each evaporator to isolate each strainer for cleaning without disrupting the operation of any remaining modules in the chiller.

Strainer Cleaning Procedure

Strainers at each evaporator are critical for protecting the brazed plate heat exchanger's small water passages as well as maintaining water/glycol mixture cleanliness. Service valves on the evaporator isolate each strainer for cleaning without interrupting the operation of other modules in the chiller bank. If a tank and pump module is provided, pot strainers are occasionally included on the pumps' suction lines.

NOTICE**Equipment Damage!**

Failure to follow instructions could result in equipment damage.

Do not operate without strainers in place.

1. De-energize power to the module containing the strainer by turning the power OFF at the breaker and/or disconnect.
2. Close the two service isolation valves between the header and the evaporator.

Note: If this is a variable flow chiller, the outlet may be equipped with an electronic valve that must be manually locked in the closed position.

3. Remove the insulation to expose the roll grooved blind end cap or service cap on the end of the strainer housing. Utilize a short section of hose to

connect to the valve on the end cap to relieve pressure and capture fluid. (Dispose of or re-utilize water/glycol mixture according to local protocols.)

⚠ CAUTION

Explosion Hazard!

Failure to relieve pressure gradually could result in minor to moderate injury and equipment damage.

Water/glycol mixture can be under considerable hydraulic pressure in the strainer housing. Close isolation valves fully. Relieve pressure using a boiler valve. Use extreme care to slowly remove the end cap and release pressure gradually.

4. Inspect the gasket and service cap for abrasions, tears, excessive dirt, or deterioration. Replace gasket if necessary.
5. Remove the strainer from the housing.
6. Clean the strainer inside and out using a soft natural bristle brush and tap water.
7. Clean the interior of the end cap (or service cap), and the gasket using a soft natural bristle brush and tap water. Apply a light coating of lubrication to the gasket.
8. Re-install the strainer in the housing (large end first). Replace the gasket and end cap and tighten coupling collar securely.
9. Ensure the water/glycol make-up system is operational to replenish the water/glycol mixture lost during the cleaning process.
10. Energize power to the module containing the strainer by turning power ON at the breaker and/or disconnect.

Evaporator Cleaning Procedure

Fouling of evaporators will result in a gradual decline in performance of the chiller.

1. Isolate each evaporator using the isolation valves.
2. Back flush using the city water supply forced to a drain.
3. A brazed-plate evaporator is cleaned by back washing which is forcing a cleansing water/glycol mixture backwards through it at higher than normal pressures.
4. Flushing should take place across a maximum 30 Mesh screen filter/strainer with frequent screen cleaning to remove the debris from the chiller. Flushing should continue until the screen is clean. After detergent and chemical cleaning, flush the piping for a minimum of one hour with fresh water to remove any remaining cleaning compounds.

Compressor Tasks

The SuperMod™ Chiller has been designed for ease of maintenance access. When properly positioned within a machine room or space, Copeland compressors can be quickly removed for repair or replacement. (See "Site Preparation and Clearances," p. 15).

Remove Compressor

1. Verify that power is turned OFF via the chiller module breaker that is found in the power distribution panel. Confirm module power is OFF by testing with known operational voltmeter. Once confirmed, install lockout/ tagout equipment to ensure power is not turned on while service work is being performed

⚠ WARNING

Hazardous Voltage!

Failure to disconnect power before servicing could result in death or serious injury.

Disconnect all electric power, including remote disconnects before servicing. Follow proper lockout/tagout procedures to ensure the power can not be inadvertently energized. Verify that no power is present with a voltmeter.

2. Recover the remaining refrigerant charge from the compressor using a suitable recovery machine and a clean recovery cylinder that is pressure rated for the refrigerant being removed. Weigh refrigerant charge that was removed.
3. Remove all compressor electrical wiring, as well as safety and crankcase heater wiring. Make sure to notate all connection points for the new installation.

Note: Be sure to document conductor/wire numbers and their corresponding termination points.

4. After ensuring the wiring is stowed away from possible heat damage, proceed with un-brazing the copper compressor connections.
5. Remove the four compressor mounting bolts from frame using two 1/2 inch sockets, or a socket and a wrench. (Install the nuts underneath the frame.)
6. Remove the compressor from the module.

Install Compressor

Verify that power is disconnected from the chiller.

⚠ WARNING

Hazardous Voltage!

Failure to disconnect power before servicing could result in death or serious injury.

Disconnect all electric power, including remote disconnects before servicing. Follow proper lockout/tagout procedures to ensure the power can not be inadvertently energized. Verify that no power is present with a voltmeter.



Maintenance Procedures

1. Position the compressor into the chiller and align the mounting holes. Apply anti-seize compound to the four mounting bolts, washers, and nuts before installation. Tighten nuts securely with 1/2 inch socket and wrench.

Note: Do not over-tighten compressor mounting bolts as the threaded inserts could strip out in the frame.

2. Reinstall and braze the refrigerant lines into the new compressor's suction and discharge stubs.
3. Charge refrigerant circuit with 150 psi dry nitrogen and conduct a bubble and electronic leak check.
4. Evacuate new compressor using the suction and discharge Schrader valves. Monitor and ensure that at least a 500 micron or lower vacuum is achieved (250 to 500 micron range would be ideal.)
5. Weigh in amount of refrigerant charge that was removed.
6. Reconnect compressor electrical connections exactly as they were removed, crankcase heater, and high pressure switch.
7. Replace the electrical and control panel cover securely.

⚠ WARNING

Hazardous Voltage!

Failure to disconnect power before servicing could result in death or serious injury.

Disconnect all electric power, including remote disconnects before servicing. Follow proper lockout/tagout procedures to ensure the power can not be inadvertently energized. Verify that no power is present with a voltmeter.

8. Restore power to the module containing the compressor by removing the lockout/tagout in the power distribution panel.
9. Energize the new compressor allowing it to run as long as possible.
10. Observe and document the operating pressures of the newly installed compressor. It is advised that the expansion valve superheat adjustment be checked.

Pump Tasks

The following section applies to those chillers equipped with a tank and pump module.

Remove Pump

Prior to servicing the pump or pump motor, verify that the power to the chiller is disconnected.

1. The pump module breaker is found in the power distribution panel. Confirm module power is OFF by testing with known operational voltmeter. Once confirmed, install lockout/tagout equipment to

ensure power is not turned on while service work is being performed.

⚠ WARNING

Hazardous Voltage!

Failure to disconnect power before servicing could result in death or serious injury.

Disconnect all electric power, including remote disconnects before servicing. Follow proper lockout/tagout procedures to ensure the power can not be inadvertently energized. Verify that no power is present with a voltmeter.

2. Remove electrical access cover on the pump motor.
3. Remove all electrical wiring and flex conduit from the pump. Make sure to notate all connection points for the new installation.

Note: Be sure to document conductor/wire numbers

4. Close valves. There are isolation valves on the suction and discharge sides of the pump as well as union connections.
5. Using appropriate wrenches, slowly break loose the union fittings at the suction and discharge piping. Capture any escaping fluids encountered during the pump change out process.

Notes:

- Always use a second, counter, wrench, when performing plumbing tasks to firmly hold the fittings or joint while loosening the tightening the opposite side.
- A small quantity of water/glycol mixture will be lost during this operation. Although propylene glycol does not pose an environmental hazard, it is the installers responsibility to adhere to local codes and ordinances involving hazardous fluids.

6. Loosen the four bolts that attach the pump base to the frame with the appropriate size wrench or socket.
7. Remove the pump.
8. Disconnect the piping stubs from the suction and discharge connections on the old pump to be reused on the new pump.

Install Pump

Verify that power is disconnected from the chiller.

⚠ WARNING

Hazardous Voltage!

Failure to disconnect power before servicing could result in death or serious injury.

Disconnect all electric power, including remote disconnects before servicing. Follow proper lockout/tagout procedures to ensure the power can not be inadvertently energized. Verify that no power is present with a voltmeter.

1. When installing the stubs from the old pump, apply a minimal amount of thread sealant, such as Rectorseal Tru-Blu with Teflon or equivalent, to the threads of the suction and discharge pipe adapters and install the adapters onto the new pump.
2. Position the pump over the mounting holes. Apply anti-seize compound to the four mounting bolts, washers, and nuts before installation. Tighten nuts securely with 1/2 inch socket and wrench.

Note: Do not over-tighten compressor mounting bolts as the threaded inserts could strip out in the frame.

3. Loosely install the four mounting bolts onto the mounting nuts on the chiller frame.
4. Align the pump suction and discharge unions onto the piping connections and hand tighten.

Note: The pump suction pipe stub must be positioned 90 degrees to the right of the pump to mate up to the union on the pump suction piping.

5. Fasten the mounting bolts to the frame using a 1/2 inch wrench or socket. Be sure to reuse the rubber isolation pads from the old pump.
6. Tighten the suction and discharge unions using large adjustable wrenches or pipe wrenches. To minimize the torque on the piping, apply an equal and opposite force to the pipe fitting with an additional adjustable wrench or pipe wrench.

Note: Always use a second, counter, wrench, when performing plumbing tasks to firmly hold the fittings or joint while loosening the tightening the opposite side.

7. Position the conduit into the knockout of the electrical box cover.
8. Fasten the conduit to the box with the ring nut.
9. Reconnect pump electrical connections exactly as they were notated at removal.
10. Replace the cover onto the electrical box on the side of the pump motor. Ensure gasket is in place prior to replacing cover.
11. Reconnect the nut on the strain relief connector from the motor housing using an adjustable wrench.
12. Open the ball valves on the suction and discharge sides of the pump.

13. Restore power to the module by removing the lockout/tagout equipment and turning the pump module breaker back to the ON position.
14. Observe the newly installed pump to verify that all connections have been seated and tightened correctly and not leaking.
15. Turn pump on and record amp draws for your records.

Replace Pump Seal

Prior to servicing the pump, verify that the power to the chiller is disconnected.

1. Confirm module power is OFF by testing with known operational voltmeter. Once confirmed, install lockout/tagout equipment to ensure power is not turned on while service work is being performed.

⚠ WARNING

Hazardous Voltage!

Failure to disconnect power before servicing could result in death or serious injury.

Disconnect all electric power, including remote disconnects before servicing. Follow proper lockout/tagout procedures to ensure the power can not be inadvertently energized. Verify that no power is present with a voltmeter.

2. Remove electrical access cover on the pump motor.
3. Remove all electrical wiring and flex conduit from the pump. Make sure to notate all connection points for the re-installation.

Note: Be sure to document conductor/wire numbers

4. Close valves. There are isolation valves on the suction and discharge sides of the pump as well as union connections.
5. Using appropriate wrenches, slowly break loose the union fittings at the suction and discharge piping. Capture any escaping fluids encountered during the pump change out process.

Notes:

- Always use a second, counter, wrench, when performing plumbing tasks to firmly hold the fittings or joint while loosening the tightening the opposite side.
 - A small quantity of water/glycol mixture will be lost during this operation. Although propylene glycol does not pose an environmental hazard, it is the installers responsibility to adhere to local codes and ordinances involving hazardous fluids.
6. Loosen the four bolts that attach the pump base to the frame with the appropriate size wrench or socket. Keep up with rubber isolation boots for reuse on install.



Maintenance Procedures

7. Remove the pump from the chiller, and take to shop bench.
8. Remove insulation from the wet end of the pump to allow volute cover access and removal.
9. Remove pump volute cover.
10. Remove retaining nut on shaft which secures seal.
11. Remove seal.
12. Remove back plate which will allow you to repair /replace water slinger.
13. Install new water slinger rubber. Replace back cover.

NOTICE

Pump Seal Damage!

Do not touch seal with bare skin, or allow any grease to come into contact with the new seal. Even a small piece of grit or dirt can damage the pump seal. Wash hands thoroughly prior to installing the new seal. Latex gloves are suggested for handling of parts after they have been cleaned and prepped.

Note: It is highly recommended that you gather seal replacement procedural information for your particular pump make and model.

14. Place the seal, sleeve, spring, and seal retainer onto the shaft.
15. Position the pump impeller and secure into place with the impeller retainer bolt.
16. Replace the volute cover with new o-ring and re-insulate.
17. Re-install pump. Attach the mounting bolts to the frame using a 1/2 inch wrench or socket.
18. Push the conduit and wires into the knockout on the electrical box cover.
19. Attach the conduit to the box with the ring nut. Use a standard screwdriver to secure the nut.
20. Secure the leads with crimp-type bell caps.
21. Reconnect pump electrical connections exactly as they were notated at removal.
22. Replace the cover onto the electrical box on the side of the pump motor. Ensure gasket is in place prior to replacing cover.
23. Reconnect suction and discharge at unions with appropriate size wrenches as with the removal process.
24. Open the ball valves on the suction and discharge sides of the pump.
25. Observe the newly installed pump to verify that all connections have been seated and tightened correctly and not leaking.
26. Restore power to the module by removing the lockout/tagout equipment and turning the pump module breaker back to the on position.
27. Turn pump on and record amp draws for your records.

Controller Tasks

Replace PLC Logic Controller

Prior to servicing the controller, verify that the power to the chiller is disconnected.

1. Remove all quick-connect black plugs and the one orange plug (power supply 24 Vac).

⚠ WARNING

Hazardous Voltage!

Failure to disconnect power before servicing could result in death or serious injury.

Disconnect all electric power, including remote disconnects before servicing. Follow proper lockout/tagout procedures to ensure the power can not be inadvertently energized. Verify that no power is present with a voltmeter.

2. The PLC logic controller is DIN rail-mounted. Once plugs are removed, this will expose the gray secure tabs on the bottom rear of the PLC.
3. Using a flathead screwdriver, insert screwdriver into the slotted holes on the gray tabs and use downward force to release PLC.
4. Remove the PLC by lifting the bottom out and then up, off of the DIN rail.
5. Replace new controller in reverse fashion.

Note: On a multiple modular system with multiple PLC's, it is imperative that the new PLC has the exact same programming as the remaining PLC's or it will not be compatible and would create havoc within the other PLCs.

6. Energize power to the module by turning power ON at the breaker and/or disconnect.



Chiller Troubleshooting

General Approach to Fault Isolation

Trane manufactures chillers with embedded fault detection and diagnostics in each module's controller that offers continuous dedicated monitoring to record and report faults as they occur in real time allowing repairs to be performed in a timely manner.

Various faults occurring in a building's HVAC system can lead to unnecessary energy consumption and poor thermal comfort for a building's occupants. Fault detection and isolation plays a significant role in

monitoring, maintaining, and repairing chillers to improve operator safety and minimize operating costs.

Fault detection is recognizing that a problem has occurred, even if the root cause is not yet known. Fault isolation is the process of reducing potential causes to determine the most likely source of chiller failure.

Controller Diagnostic Codes

The following table assists in explaining the alarm codes that appear in the remote interface panel in the event of an alarm. The alarm history is accessed by pressing the alarm log key.

Table 11. Interface panel diagnostic code key

ALARM	RESET	ACTION
BMS offline	Auto	Warning
Compressor 1/2 CoreSense Failure	Auto	Shuts down compressor 1/2
Compressor 1/2 Failure	Auto	Shuts down compressor 1/2
Compressor 1/2 Lockout	Auto	Shuts down Circuit 1/2
Compressor 1/2 Offline	Auto	Shuts down compressor 1/2
Compressor 1/2 Warning	Auto	Warning
Condenser Flow Alarm	User	Shuts down Circuits / Circuit 1 in Constant Flow systems
Condenser LWT too low	Auto	Warning
c.pCOe Offline Alarm	Auto	Shuts down Circuit 2
c.pCOe UI1 sensor failure	Auto	Shuts down Circuit 2 if Low Pressure sensor selected for Suction Pressure Alarm
c.pCOe UI2 sensor failure	Auto	Shuts down Circuit 2
c.pCOe wrong config Alarm	Auto	Warning
Error in retain memory writings	User	Warning
Error in the number of retain memory writings	User	Warning
Evaporator Flow Alarm	User	Locks out module in Variable Flow systems
Evaporator Freezing Alarm	User	Locks out module
Evaporator LWT too high	Auto	Warning
HP Alarm	User	Shuts down Circuit 1/2
HP Switch Alarm	User	Shuts down Circuit 1/2
LP Alarm	Auto	Shuts down Circuit 1/2
LP Lockout Alarm	User	Shuts down Circuit 1/2
Primary communication lost	Auto	Secondary modules switch into Stand-alone Mode
Phase Monitor Alarm	Auto	Locks out module
Secondary 1/2/3/4/5/6/7/8/9 communication lost	Auto	Warning
System Chilled LWT too high	Auto	Warning

Table 11. Interface panel diagnostic code key (continued)

ALARM	RESET	ACTION
System Hot LWT too low	Auto	Warning
UI1 sensor failure	Auto	Shuts down circuit 1 if Low Pressure sensor selected for Suction Pressure Alarm
UI2 sensor failure	Auto	Shuts down Circuit 1
UI3 sensor failure	Auto	Shuts down local cooling control if Module is in Stand-alone Mode and respective Entering / Leaving Water sensor selected for Temperature Control
UI4 sensor failure	Auto	Locks out module
UI5 sensor failure	Auto	Shuts down local heating control if Module is in Stand-alone Mode and respective Entering / Leaving Water sensor selected for Temperature Control
UI6 sensor failure	Auto	Shuts down Free Cooling control if Module is in Stand-alone Mode and respective Entering / Leaving Water sensor selected for Temperature Control
UI7 sensor failure	Auto	Modules switch into Stand-alone Mode if both respective Cooling / Heating Mode selected and respective Entering / Leaving Water sensor selected for Temperature Control
UI8 sensor failure	Auto	Modules switch into Stand-alone Mode if both respective Cooling / Heating Mode selected and respective Entering / Leaving Water sensor selected for Temperature Control
UI9 sensor failure	Auto	Modules switch into Stand-alone Mode if both respective Cooling / Heating Mode selected and respective Entering / Leaving Water sensor selected for Temperature Control
UI10 sensor failure	Auto	Modules switch into Stand-alone Mode if both respective Cooling / Heating Mode selected and respective Entering / Leaving Water sensor selected for Temperature Control
UI11 sensor failure	Auto	Control panel heating / cooling control is disabled
UI12 sensor failure	Auto	Warning
Wrong local rotation control parameters	Auto	Warning
Wrong primary rotation control parameters	Auto	Warning
Wrong temperature control parameters	Auto	Warning

Compressor Diagnostic Codes

Copeland compressors used in Trane chillers are highly automated with digital capability to record and report a range of operating parameters and critical events. This technology can be employed to assist in troubleshooting compressor faults and potential corrective action.

CoreSense Flash Codes

The CoreSense technology in the Copeland compressor will communicate an abnormal system condition through a unique flash code:

ALERT LED (Yellow): The ALERT LED will flash a number of times consecutively, pause and then repeat the process. The number of consecutive flashes, defined as the flash code, correlates to a specific anomaly or abnormal condition.

TRIP/LOCK LED (Red): indicates either a TRIP or LOCK condition.

- **TRIP** is indicated by a solid illumination of the LED. This means the compressor is not running and demand is present at the module.
- **LOCK** is indicated by a flashing LED correlating to a lock condition in which the module will prevent the compressor from starting.

CoreSense Flash Code Description

Copeland compressors will report a range of flash codes when specific critical events occur. See [Table 11, p. 55](#).

CODE 1 – Long Run Time: The module will flash yellow one time when the compressor operates for longer than 18 continuous hours. This is an alert code only and the module will not lockout the compressor for this condition. (This code is inactive for heat pumps.)

CODE 2 – Compressor (Pressure) Trips: The module will flash yellow two times when the compressor operates from 12 seconds to 15 minutes followed by a

trip condition lasting longer than 7 minutes. When four consecutive or ten total CODE 2 events are recorded, the module will lockout the compressor and flash red two times.

CODE 3 – Pressure Switch Cycling: The module will flash yellow three times when the compressor operates from 12 seconds to 15 minutes followed by a trip condition lasting between 35 seconds to 7 minutes. When four consecutive or ten total CODE 3 events are recorded, the module will lockout the compressor and flash red three times.

CODE 4 – Locked Rotor Trip: The module will flash yellow four times when the compressor trips within 12 seconds of operation and does not reset and start within 35 seconds. When ten consecutive CODE 4 events are recorded the module will lockout the compressor and flash red four times.

CODE 5 – Compressor (Moderate Run) Trip: The module will flash yellow five times when the compressor has operated between 15 minutes and 18 hours, followed by a compressor trip lasting longer than 7 minutes. When four consecutive or ten total CODE 5 events are recorded, the module will lockout the compressor and flash red five times.

CODE 6 – Open Start Circuit: The module will lockout the compressor and flash red six times if the module

detects a demand signal in the Y terminal and current in the S winding of the compressor, but no current is detected in the S winding of the compressor for 2 seconds.

CODE 7 – Open Run Circuit: The module will lockout the compressor and flash red seven times if the module detects a demand signal in the Y terminal and current in the S winding of the compressor, but no current is detected in the R winding of the compressor for 2 seconds.

CODE 8 – Welded Contactor: The module will flash yellow eight times if it has detected line currents in the S and R windings and demand is absent for 15 seconds.

CODE 9 – Low Voltage: The module will flash nine times if the module supply voltage drops below 17 Vac for 2 seconds. The module will prevent the compressor from starting until adequate voltage is established.

CODE 10 – Over-Current Protection: When the current at the PROT terminal is greater than 2A for 40 milliseconds, the module will flash a CODE10. The red LED will flash 10 times with the yellow LED remaining off. This event will cause a lockout of the compressor and indicates that the module is mis-wired or the contactor coil is shorted to ground.

Table 12. Compressor fault code summary





AlertCode	Alert Condition	Lockout Level	Lockout Indication
Normal Run Solid Green	Normal operation, no alarm status.	N/A	N/A
CODE 1 Yellow Flash 1	Long run time. Compressor is running for more than 18 hours at full load. (CODE 1 is disabled in heat pump mode.)	N/A	N/A
CODE 2 Yellow Flash 2	Compressor pressure trip. Compressor runs for 12 seconds to 15 minutes followed by a compressor trip condition lasting longer than 7 minutes.	4x consecutive, 10x total	Red:Flash 2
CODE 3 Yellow Flash 3	Pressure switch cycling. Compressor runs for 12 seconds to 15 minutes followed by a compressor trip lasting 35 seconds to 7 minutes.	4x consecutive, 10 total	Red:Flash 3
CODE 4 Yellow Flash 4	Locked rotor. Compressor trips within a compressor run time of 12 seconds and does not start within 35 seconds.	10x consecutive	Red:Flash 4
CODE 5 Yellow Flash 5	Compressor moderate run trip. Compressor runs for 15 minutes to 18 hours followed by a compressor trip lasting longer than 7 minutes.	4x consecutive, 10x total	Red:Flash 5
CODE 6 Red Flash 6	Open start circuit. Module has detected Y or Y1 , and current in the R winding of the compressor and no current in the S winding of the compressor for 2 seconds.	1 occurrence	Red:Flash 6
CODE 7 Red Flash 7	Open run circuit. Module has detected Y or Y1 , and current in the S winding of the compressor and no current in the R winding of the compressor for 2 seconds.	1 occurrence	Red:Flash 7
CODE 8 Yellow Flash 8	Welded contactor. Module has detected line currents in R and S windings, and Y or Y1 is at 0 Vac for 15 seconds.	N/A	N/A
CODE 9 Yellow Flash 9	Low voltage. Module has detected a 24 Vac supply voltage below 17 Vac \pm 1 Vac for 2 seconds.	N/A	N/A
CODE 10 Red Flash 10	Over current protection. PROT terminal has above a 2A input for more than 40 milliseconds.	1 occurrence	Red:Flash 10

Phase Monitor Protection

If the chiller fails to power up, eliminate electrical phase issues by inspecting the phase monitor device located in the power distribution panel.

When all voltages are acceptable and the phase sequence is correct the output relay is energized and the LED glows green. Under-voltages and unbalanced voltages must be sensed for a continuous trip delay period before the relay de-energizes. Reset is automatic upon correction of the fault condition. The output relay will not energize if a fault condition is sensed as power is applied. The LED flashes red during the trip delay, then glows red when the output de-energizes. The LED flashes green/red if phase reversal is sensed.

Table 13. LED phase monitor diagnostic codes

LED Display	Indication
	Glowing green: All voltages are acceptable and phase sequence is correct.
	Flashing red: Trip delay prior to de-energizing. Glowing red: Output has been de-energized upon fault detection.
	Flashing red and green: Phase reversal is detected.
	No power to phase monitor.

If the phase monitor fails to energize (the LED glows red) check wiring of all three phases, voltage, and phase sequence. If phase sequence is incorrect, the LED flashes green/red. To correct this, swap any two line voltage connections at the mounting socket. No further adjustment should be required.

Symptoms and Solutions

This section lists the most common troubleshooting symptoms and the closest potential solution for each. The "References" column will list a reference within this manual, if applicable. This is not an exhaustive listing of all potential causes or resolutions, but represents the best direction in which to initiate a solution.

Note: An anti-short cycle timer is included in the primary microprocessor controller to prevent the compressors from starting until the delay has elapsed. The microprocessor also provides minimum compressor run timers. Take these fixed timer parameters into consideration when conducting a fault isolation process.

1. Symptom: Compressor will not start	
Possible Causes	Potential Solutions
Temperature control not in demand	Set point has been reached
Pressure switch open due to low water flow	Condenser side loss of flow; open switch
Low pressure switch open	Low pressure event has occurred
High pressure switch open	High pressure event has occurred
Compressor overload opened	Allow motor to cool and reset; High amp load/floodback
No power to module	Check breakers and fuses; energize from module electrical and control panel
Phase monitor open or tripped	Over/under 4% to 8%; loss of leg

2. Symptom: Compressor will not run	
Possible Causes	Potential Solutions
Compressor will not run	Assure all breakers and switches are on
Main switch open or circuit breakers open	Check circuits and motor winding for shorts or grounds
Fuse is blown	Replace fuse or reset breakers after fault is corrected

2. Symptom: Compressor will not run	
Possible Causes	Potential Solutions
Investigate for possible overloading	Overloads are auto-reset. Monitor to assure the overload does not re-occur.
Thermal overload breaker tripped or fuses blown	Repair or replace
Defective contactor or coil	Determine type and cause. Correct fault before resetting safety.
System shut down by safety devices	Repair or replace coil
Liquid line solenoid will not open	Check motor for open circuit, short circuit, or motor burnout
Motor electrical trouble	Tighten all terminal screws

3. Symptom: Compressor has excessive noise or vibration	
Possible Causes	Potential Solutions
Flooding of refrigerant into crankcase	Check setting of expansion valve
Improper discharge piping support	Relocate, add, or remove supports
Improper or worn compressor supports	Replace supports
Worn compressor	Replace or rebuild compressor

4. Symptom: Compressor will not load or unload	
Possible Causes	Potential Solutions
Defective capacity control	Repair or replace module
Unloader mechanism defective	Replace unloader
Faulty thermostat gauge or broken capillary tube	Replace thermostat assembly
Stages not properly set for application	Reset thermostat setting for operating requirements

5. Symptom: Compressor Loading/Unloading Cycles Too Short	
Possible Causes	Potential Solutions
Temperature differential set too low (4 °F (2 °C) minimum)	Ramp/set temperature set point
Erratic water thermostat device	Replace thermostat assembly
Insufficient evaporator water flow	Adjust flow rate or remove flow

6. Symptom: Compressor loses oil	
Possible Causes	Potential Solutions
Low refrigerant charge	Check for leaks and repair. Add refrigerant to proper charge.
Gas velocity in risers too low	Check riser sizes against compressor gas flow
Oil trapped in line	Check pitch of lines and refrigerant velocities
Excessive compression ring blow by	Replace or rebuild compressor
Liquid refrigerant	Check compressor superheat. Superheat at the compressor suction should be approximately 15° F (8.3° C).



Chiller Troubleshooting

7. Symptom: Low refrigeration suction pressure	
Possible Causes	Potential Solutions
Lack of refrigerant	Check for leaks. Repair and add charge.
Evaporator dirty	Clean chemically
Clogged suction line or suction gas strainers	Clean strainers
Condensing temperature too low	Check condensing temperature regulation system
Low water temperature	Raise set point; check design specification
Compressor will not unload	Replace solenoid or controller
Low discharge pressure	Refrigerant charge; replace compressor
Expansion valve malfunctioning	Reset for proper superheat (10-12 ° SH)
Mis-adjusted or defective TXV	Adjust or replace valve
Receiver service valve closed	Turn counterclockwise completely. Do not fully backseat if pressure switch is installed on service port
Compressor service valves closed	Dangerous! Turn counterclockwise completely
Clogged liquid line filter-drier	Replace cartridges
Excessive glycol concentration	Drain, refill (deionized water), retest
Liquid line solenoid restricted or faulty	Replace solenoid valve, coil, or internals as necessary
Insufficient chilled water	Adjust flow rate across evaporator
Restricted water/glycol line	Clean strainers; check manual and electronic valves
Water/glycol mixture contaminated	Intensive cleanup effort needed to identify source of contamination; external filter may be required
Evaporator tubing clogged or fouled	Reverse flush with appropriate chemical solutions

8. Symptom: High refrigeration suction pressure	
Possible Causes	Potential Solutions
Expansion valve opened too far	Re-adjust to 10° to 12°
Excessive refrigerant charge	Creates high pressure alarms; reclaim excess refrigerant and verify proper sub-cooling and superheat.
High water temperature	Low refrigerant charge; failing compressor; check design specifications

9. Symptom: Low refrigerant discharge pressure	
Possible Causes	Potential Solutions
Suction shut off valve partially closed	Open valve
Insufficient refrigerant in chiller	Check for leaks. Repair and add refrigerant as needed
Compressor operating unloaded	See failure of compressor to unload or load up below
Low ambient conditions	Check condenser rating tables
Low suction pressure	See low pressure below
Condenser pressure regulating valve not properly adjusted	Refer to OEM manufacturer manual for default settings; check equipment room ambient temperature
Fan cycling controls not properly set	Reset cut-in, cut-out settings to conform to design specifications

10. Symptom: High refrigerant discharge pressure	
Possible Causes	Potential Solutions
System overcharged with refrigerant	Remove excess refrigerant
Dirty tube and fin surface	Clean with compressed air or water spray, use fin comb if fins are bent
Non-condensables in chiller	Purge non-condensables.
Fan cycling controls not properly set	Reset fan cycle setting; replace motor controller fuse
Condensing fans not operating	Reset fan cycle setting; replace motor controller fuse
Restricted bypass line	Check valves obstructed; flush line; blow out line with dry nitrogen gas
Discharge shut off valve partially closed	Open valve
Condenser is undersized	Check condenser rating tables with operating parameters
High ambient conditions exist	Check condenser rating tables with operating parameters

11. Symptom: Low chilled water temperature	
Possible Causes	Potential Solutions
Temperature controllers set too low	Reset temperature controllers to correct design specifications
Water velocity through evaporator too low	Clean strainer; check pump, VFD, and differential pressure settings
Temperature controllers malfunctioning	Replace temperature sensor

12. Symptom: High chilled water temperature	
Possible Causes	Potential Solutions
Load higher than capacity of chiller	Refer to chiller design specifications
Loss of refrigeration charge	Pressure test refrigeration system
Fouled evaporator	Reverse flush evaporator; check strainer for debris
Obstructed flow through evaporator	Reverse flush evaporator; check strainer for debris; check VFD, pump, valves

13. Symptom: Compressor thermal protector switch open	
Possible Causes	Potential Solutions
Operating beyond design conditions	Check fan switch or fan pressure settings as appropriate
Discharge valve partially shut	Open valve
Faulty compressor overload	Replace overload if external type provided

14. Symptom: No low voltage (24 Vac)	
Possible Causes	Potential Solutions
Control circuit fuse open	Check fuse prong contact points; replace fuse
Phase monitor opened or tripped	Check for correct voltages
Transformer T1 defective	Replace transformer T1, T2, T3
No primary voltage on T1	Check breakers, fuses; check power supply specifications



Chiller Troubleshooting

15. Symptom: Expansion valve superheat too high	
Possible Causes	Potential Solutions
Water/glycol temperature too warm	Low refrigerant level; recharge chiller
Obstructed filter dryer	Replace dryer core
Low refrigerant charge	Recharge refrigerant as per data plate
Improperly adjusted superheat valve setting	Reset valve settings to factory specifications

16. Symptom: Expansion valve superheat too low	
Possible Causes	Potential Solutions
Temperature sensor not properly located	Check if secured to pipe or insulated; check sensor position on pipe at 4-8-10-2 clock positions
Evaporator pressure transducer issue	Check pressure transducer location and accuracy
Valve setting incorrect	Re-adjust to 10° to 12°

17. Symptom: Contactor/relay inoperative	
Possible Causes	Potential Solutions
Coil shorted or open	Replace coil
Mechanical parts broken or jammed	Replace assembly
Contacts pitted or burned	Replace contactors
No 24 Vac to coil	Replace secondary fuse to T2 transformer

18. Symptom: Freeze protection safety activated	
Possible Causes	Potential Solutions
Thermostat set too low	Reset above freezing temperature at evaporate or discharge
Low water flow	Remove restrictions. Increase HP
Low suction pressure	See "low suction pressure"

Variable Frequency Drive Diagnostics

A comprehensive user's manual for the Emerson Copeland Scroll EVC1150B/1185B Variable Frequency Drive (VFD) can be located and downloaded from <https://climate.emerson.com/documents/evc-series-zpv066-zpv096-user-guide-en-3671334.pdf>.

Status Modes

The keypad display and LED on the VFD gives various information about the status of the drive including trip, alarm, and status indications.

Table 14. Status indications

Upper Row String	Description	Drive Output Stage
Inhibit	The drive is inhibited and cannot be run. The Safe Torque Off signal is not applied to Safe Torque Off terminals or Pr 06.015 is set to 0.	Disabled
Ready	The drive is ready to run. The drive enable is active, but the drive inverter is not active because the final drive run is not active.	Disabled
Stop	The drive is stopped / holding zero speed.	Enabled
Run	The drive is active and running.	Enabled
Supply Loss	Supply loss condition has been detected.	Enabled

Table 14. Status indications (continued)

Upper Row String	Description	Drive Output Stage
Deceleration	The motor is being decelerated to zero speed / frequency because the final drive run has been deactivated.	Enabled
Trip	The drive has tripped and no longer controlling the motor. The trip code appears in the lower display.	Disabled
Active	The regen unit is enabled and synchronized to the supply.	Enabled
Under Voltage	The drive is in the under voltage state either in low voltage or high voltage mode.	Disabled
Heat	The motor pre-heat function is active.	Enabled

Figure 25. Status indications

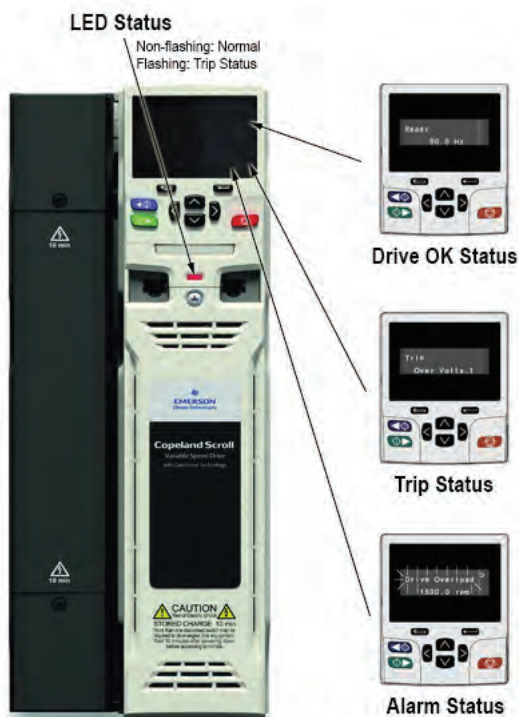

Alarm Indications

In any mode, an alarm is an indication given on the display by alternating the alarm string with the drive status string on the first row and showing the alarm symbol in the last character in the first row. If an action is not taken to eliminate any alarm except the drive may eventually trip. Alarms are not displayed when a parameter is being edited, but the user will still see the alarm character on the upper row.

Table 15. Alarm indications

Alarm String	Description
Ind Overload	Regen inductor overload. Inductor Protection Accumulator (04.019) in the drive has reached 75.0% of the value at which the drive will trip and the load on the drive is >100%.
Drive Overload	Drive over temperature. Percentage Of Drive Thermal Trip Level (07.036) in the drive is greater than 90%.
Limit Switch	Limit switch active. Indicates that a limit switch is active and that is causing the motor to be stopped.

Chiller Troubleshooting

Trip Indications

The keypad display and LED on the VFD gives various information about the status of the drive including trip, alarm, and status indications.

The output of the drive is disabled under any trip condition so that the drive stops controlling the motor. If the motor is running when the trip occurs, it will coast to a stop.

During a trip condition, where a KI-Keypad is being used, the upper row of the display indicates that a trip has occurred and the lower row of the keypad display will display the trip string. Some trips have a sub-trip

number to provide additional information about the trip. If a trip has a sub-trip number, the sub-trip number is flashed alternately with the trip string unless there is space on the second row for both the trip string and the sub-trip number in which case both the trip string and sub-trip information is displayed separated by a decimal place.

The back-light of the KI-Keypad display will also flash during a trip condition. If a display is not being used, the drive LED Status indicator will flash with 0.5 s duty cycle if the drive has tripped.

Table 16. Trip Indications

Trip	Diagnosis	Recommended Actions
28	An Input 1 Loss: An Input 1 Loss trip indicates that a current loss was detected in current mode on Analog input 1 (Terminal 5, 6). In 4-20 mA and 20-4 mA modes loss of input is detected if the current falls below 3 mA.	<ul style="list-style-type: none"> Check control wiring is correct Check control wiring is undamaged Check the Analog Input 1 Mode (07.007) Current signal is present and greater than 3 mA
29	An Input 2 Loss: An Input 2 Loss indicates that a current loss was detected in current mode on Analog input 2 (Terminal 7). In 4-20 mA and 20-4 mA modes loss of input is detected if the current falls below 3 mA.	<ul style="list-style-type: none"> Check control wiring is correct Check control wiring is undamaged Check the Analog Input 2 Mode (07.011) Current signal is present and greater than 3 mA
219	An Output Calib: The An output Calib trip indicates that one or both of the Analog outputs have failed during the zero offset calibration. The failed output can be identified by the sub-trip number.	<ul style="list-style-type: none"> Check the wiring associated with analog outputs Remove all the wiring that is connected to analog outputs and perform the calibration If trip persists replace the drive
185	Card Access: The Card Access trip indicates that the drive was unable to access the NV Media Card. If the trip occurs during the data transfer to the card then the file being written may be corrupted. If the trip occurs when the data being transferred to the drive then the data transfer may be incomplete. If a parameter file is transferred to the drive and this trip occurs during the transfer, the parameters are not saved to non-volatile memory, and so the original parameters can be restored by powering the drive down and up again.	<ul style="list-style-type: none"> Check NV Media Card is installed / located correctly Replace the NV Media Card
177	Card Boot: Menu 0 changes are automatically saved on exiting edit mode. The Card Boot trip will occur if a write to a Menu 0 parameter has been initiated via the keypad by exiting edit mode and Pr 11.042 is set for auto or boot mode, but the necessary boot file has not been created on the NV Media Card to take the new parameter value. This occurs when Pr 11.042 is changed to Auto (3) or Boot (4) mode, but the drive is not subsequently reset.	<ul style="list-style-type: none"> Ensure that Pr 11.042 is correctly set, and then reset the drive to create the necessary file on the NV Media Card Re-attempt the parameter write to the Menu 0 parameter
178	Card Busy: The Card Busy trip indicates that an attempt has been made to access a file on NV Media Card, but the NV Media Card is already being accessed by an option module, such as one of the Applications modules. No data is transferred.	Wait for the option module to finish accessing the NV Media Card and re-attempt the required function
179	Card Data Exists: The Card Data Exists trip indicates that an attempt has been made to store data on a NV Media Card in a data block which already contains data.	<ul style="list-style-type: none"> Erase the data in data location Write data to an alternative data location

Table 16. Trip Indications (continued)

Trip	Diagnosis	Recommended Actions
188	<p>Card Compare: A compare has been carried out between a file on the NV Media Card, a Card Compare trip is initiated if the parameters on the NV Media Card are different to the drive.</p>	<ul style="list-style-type: none"> • Set Pr mm.000 to 0 and reset the trip • Check to ensure the correct data block on the NV Media Card has been used for the compare
187	<p>Card Drive Mode: The Card Drive Mode trip is produced during a compare if the drive mode in the data block on the NV Media Card is different from the current drive mode. This trip is also produced if an attempt is made to transfer parameters from a NV Media Card to the drive if the operating mode in the data block is outside the allowed range of operating modes.</p>	<ul style="list-style-type: none"> • Ensure the destination drive supports the drive operating mode in the parameter file. • Clear the value in Pr mm.000 and reset the drive • Ensure destination drive operating mode is the same as the source parameter file
182	<p>Card Error: The Card Error trip indicates that an attempt has been made to access a NV Media Card but an error has been detected in the data structure on the card. Resetting the trip will cause the drive to erase and create the correct folder structure. The cause of the trip can be identified by the sub-trip.</p>	<ul style="list-style-type: none"> • Erase all the data block and re-attempt the process • Ensure the card is located correctly • Replace the NV Media Card
184	<p>Card Full: The Card Full trip indicates that an attempt has been made to create a data block on a NV Media Card, but there is not enough space left on the card.</p>	<ul style="list-style-type: none"> • Delete a data block or the entire NV Media Card to create space • Use a different NV Media Card
183	<p>Card No Data: The Card No Data trip indicates that an attempt has been made to access non-existent file or block on a NV Media Card.</p>	<p>Ensure data block number is correct</p>
180	<p>Card Option: The Card Option trip indicates that parameter data or default difference data is being transferred from a NV Media Card to the drive, but the option module categories are different between source and destination drives. This trip does not stop the data transfer, but is a warning that the data for the option modules that are different will be set to the default values and not the values from the card. This trip also applies if a compare is attempted between the data block and the drive.</p>	<ul style="list-style-type: none"> • Ensure the correct option modules are installed. • Ensure the option modules are in the same option module slot as the parameter set stored. • Press the red reset button to acknowledge that the parameters for one or more of the option modules installed will be at their default values • This trip can be suppressed by setting Pr mm.000 to 9666 and resetting the drive.
175	<p>Card Product: The Card Product trip is initiated either at power-up or when the card is accessed, If Drive Derivative (11.028) is different between the source and target drives. This trip can be reset and data can be transferred in either direction between the drive and the card.</p>	<ul style="list-style-type: none"> • Use a different NV Media Card • This trip can be suppressed by setting Pr mm.000 to 9666 and resetting the drive
186	<p>Card Rating: The Card Rating trip indicates that parameter data is being transferred from a NV Media Card to the drive, but the current and / or voltage ratings are different between source and destination drives. This trip also applies if a compare (using Pr mm.000 set to 8yyy) is attempted between the data block on a NV Media Card and the drive. The Card Rating trip does not stop the data transfer but is a warning that rating specific parameters with the RA attribute may not be transferred to the destination drive.</p>	<ul style="list-style-type: none"> • Reset the drive to clear the trip • Ensure that the drive rating dependent parameters have transferred correctly
181	<p>Card Read Only: The Card Read Only trip indicates that an attempt has been made to modify a read-only NV Media Card or a read-only data block. A NV Media Card is read-only if the read-only flag has been set.</p>	<p>Clear the read only flag by setting Pr mm.000 to 9777 and reset the drive. This will clear the read-only flag for all data blocks in the NV Media Card</p>

Chiller Troubleshooting

Table 16. Trip Indications (continued)

Trip	Diagnosis	Recommended Actions
35	Control Word: The Control Word trip is initiated by setting bit 12 on the control word in Pr 06.042 when the control word is enabled (Pr 06.043 = On).	<ul style="list-style-type: none"> • Check the value of Pr 06.042 • Disable the control word in Control Word Enable (Pr 06.043) Bit 12 of the control word set to a one causes the drive to trip on Control Word. When the control word is enabled, the trip can only be cleared by setting bit 12 to zero
225	Current Offset: The Current Offset trip indicates that the current offset is too large to be trimmed.	<ul style="list-style-type: none"> • Ensure that there is no possibility of current flowing in the output phases of the drive when the drive is not enabled • Hardware fault – Contact the supplier of the drive
97	Data Changing: A user action or a file system write is active that is changing the drive parameters and the drive has been commanded to enable, i.e. Drive Active (10.002) = 1.	Ensure the drive is not enabled when one of the following is being carried out: Loading defaults / Changing drive mode / Transferring data from NV Media Card or position feedback device / Transferring user programs
199	Destination: The Destination trip indicates that destination output parameters of two or more logic functions (Menus 3, 7, 8, 9, 12 or 14) within the drive are writing to the same parameter.	Set Pr mm.000 to 'Destinations' or 12001 and check all visible parameters in all menus for parameter write conflicts
224	Drive Size: The Drive Size trip indicates that the control PCB has not recognized the drive size of the power circuit to which it is connected.	<ul style="list-style-type: none"> • Ensure the drive is programmed to the latest firmware version • Hardware fault - return drive to supplier
248	Derivative Image: The Derivative Image trip indicates that an error has been detected in the derivative image.	Contact the supplier of the drive
31	EEPROM Fail: The EEPROM Fail trip indicates that default parameters have been loaded. The exact cause/reason of the trip can be identified from the sub-trip number.	<ul style="list-style-type: none"> • Default the drive and perform a reset • Allow sufficient time to perform a save before the supply to the drive is removed • If the trip persists - return drive to supplier
HF01 - HF20	Hardware Fault	Contact the supplier of the drive
26	I/O Overload: The I/O Overload trip indicates that the total current drawn from 24 V user supply or from the digital output has exceeded the limit. A trip is initiated if one or more of the following conditions: <ul style="list-style-type: none"> • Maximum output current from one digital output is 100 mA • The combined maximum output current from outputs 1 and 2 is 100 mA • The combined maximum output current from output 3 and +24 V output is 100 mA 	<ul style="list-style-type: none"> • Check total loads on digital outputs • Check control wiring is correct • Check output wiring is undamaged
23	OHT Control: This OHT Control trip indicates that a control stage over-temperature has been detected. From the sub-trip 'xxyz', the Thermistor location is identified by 'zz'.	<ul style="list-style-type: none"> • Check enclosure / drive fans are still functioning correctly • Check enclosure ventilation paths • Check enclosure door filters • Increase ventilation • Reduce the drive switching frequency • Check ambient temperature

Table 16. Trip Indications (continued)

Trip	Diagnosis	Recommended Actions
27	<p>OHT dc bus: The OHT dc bus trip indicates a DC bus component over temperature based on a software thermal model. The drive includes a thermal protection system to protect the DC bus components within the drive. This includes the effects of the output current and DC bus ripple. The estimated temperature is displayed as a percentage of the trip level in Pr 07.035. If this parameter reaches 100 % then an OHT dc bus trip is initiated. The drive will attempt to stop the motor before tripping. If the motor does not stop in 10 s the drive trips immediately.</p>	<ul style="list-style-type: none"> • Check the AC supply voltage balance and levels • Check DC bus ripple level • Reduce duty cycle • Reduce motor load • Check the output current stability
21	<p>OHT Inverter: This trip indicates that an IGBT junction over-temperature has been detected based on a software thermal model.</p>	<ul style="list-style-type: none"> • Reduce the selected drive switching frequency • Ensure Auto-switching Frequency Change Disable (05.035) is set to Disabled (1) • Reduce duty cycle • Decrease acceleration / deceleration rates • Reduce motor load • Check DC bus ripple • Ensure all three input phases are present and balanced
22	<p>OHT Power: This trip indicates that a power stage over-temperature has been detected. From the sub-trip 'xyzz', the Thermistor location is identified by 'zz'.</p>	<ul style="list-style-type: none"> • Check enclosure / drive fans are still functioning correctly • Force the heatsink fans to run at maximum speed • Check enclosure ventilation paths • Check enclosure door filters • Increase ventilation • Reduce the drive switching frequency • Reduce duty cycle • Decrease acceleration / deceleration rates • Reduce motor load • Check the derating tables and confirm the drive is correctly sized for the application. • Use a drive with larger current / power rating
102	<p>OHT Rectifier: The OHT Rectifier indicates that a rectifier over-temperature has been detected. The thermistor location can be identified from the sub-trip number.</p>	<ul style="list-style-type: none"> • Check the motor and motor cable insulation with an insulation tester • Fit an output line reactor or sinusoidal filter • Force the heatsink fans to run at maximum speeds by setting Pr 06.045 = 11 • Check enclosure / drive fans are still functioning correctly • Check enclosure ventilation paths • Check enclosure door filters • Increase ventilation • Decrease acceleration / deceleration rates • Reduce duty cycle • Reduce motor load

Chiller Troubleshooting

Table 16. Trip Indications (continued)

Trip	Diagnosis	Recommended Actions
3	OI ac: The instantaneous drive output current has exceeded above VM_DRIVE_CURRENT_MAX.	<ul style="list-style-type: none"> • Acceleration/deceleration rate is too short • Check for short circuit on the output cabling • Check integrity of the motor insulation using an insulation tester • Check feedback device wiring • Check feedback device mechanical coupling • Check feedback signals are free from noise • Is motor cable length within limits for the frame size
109	OI dc: The OI dc trip indicates that the short circuit protection for the drive output stage has been activated.	<ul style="list-style-type: none"> • Disconnect the motor cable at the drive end and check the motor and cable insulation with an insulation tester • Replace the drive
92	OI Snubber: The OI Snubber trip indicates that an over-current condition has been detected in the rectifier snubber circuit. The reason for the trip can be identified by the sub-trip number.	<ul style="list-style-type: none"> • Ensure the internal EMC Filter is installed • Ensure the motor cable length does not exceed the maximum for selected switching frequency • Check for supply voltage imbalance • Check for supply disturbance such as notching from a DC drive • Check the motor and motor cable insulation with an insulation tester • Fit an output line reactor or sinusoidal filter
98	Out Phase Loss: The Out Phase Loss trip indicates that a phase loss has been detected at the drive output. If Output Phase Loss Detection Enable (06.059) = 1 then output phase loss is detected as follows: 1. When the drive is enabled short pulses are applied to make sure each output phase is connected. 2. During running the output current is monitored and the output phase loss condition is detected if the current contains more than TBD % negative phase sequence current for TBDs.	<ul style="list-style-type: none"> • Check motor and drive connections • To disable the trip set Output Phase Loss Detection Enable (06.059) = 0
222	Over Frequency: The Over Frequency trip indicates that the output frequency has exceeded 560 Hz for more than 4 ms.	
7	Over Speed: If the Speed Feedback Pr 00.011 {29.020} exceeds the Over Speed Threshold in Pr 03.008 an Over Speed trip is produced. If Pr 03.008 is set to 0.0 the threshold is then equal to 1.2 x the value set in Pr 01.006. For compressor applications, the Over Speed trip can occur if the rotor is locked and thus the speed estimator is not valid. The trip is latched and requires a power-cycle to reset in order to conform to UL testing. The above description relates to a standard over speed trip, however in RFC-S mode it is possible to produce an Over Speed trip with sub-trip 1. This is caused if the speed is allowed to exceed the safe level in RFC-S mode with flux weakening. See Enable High Speed Mode (05.022) for details.	Reduce the Speed Controller Proportional Gain (03.010) to reduce the speed overshoot
2	Over Volts: The Over Volts trip indicates that the DC bus voltage has exceeded the VM_DC_VOLTAGE[MAX] or VM_DC_VOLTAGE_SET[MAX] for 15 s.	<ul style="list-style-type: none"> • Increase deceleration ramp (Pr 00.004) • Check nominal AC supply level • Check for supply disturbances which could cause the DC bus to rise • Check motor insulation using a insulation tester

Table 16. Trip Indications (continued)

Trip	Diagnosis	Recommended Actions
32	Phase Loss: The Phase Loss trip indicates that the drive has detected an input phase loss or large supply imbalance. The drive will attempt to stop the motor before this trip is initiated. If the motor cannot be stopped in 10 s, the trip occurs immediately. The Phase Loss trip works by monitoring the ripple voltage on the DC bus of the drive, if the DC bus ripple exceeds the threshold, the drive will trip on Phase Loss. Potential causes of the DC bus ripple are input phase loss, large supply impedance, and severe output current instability. Input phase loss detection can be disabled when the drive is required to operate from the DC supply or from a single phase supply in Input Phase Loss Detection Mode (06.047).	<ul style="list-style-type: none"> • Check the AC supply voltage balance and level at full load • Check the DC bus ripple level with an isolated oscilloscope • Check the output current stability • Reduce the duty cycle • Reduce the motor load • Disable the phase loss detection, set Pr 06.047 to 2
198	Phasing Error: For compressor applications, the phasing error trip can occur if the rotor is locked and thus the rotor cannot be synchronized.	This trip is latched and requires a power-cycle to reset to conform to UL testing.
90	Power Comms: The Power Comms trip is initiated if there is no communications between power, control or the rectifier module or if excessive communication errors have been detected. The reason for the trip can be identified by the sub-trip number.	Hardware fault – Contact the supplier of the drive
220	Power Data: The Power Data trip indicates that there is an error in the configuration data stored in the power system.	Hardware fault – Contact the supplier of the drive
37	Power Down Save: The Power Down Save trip indicates that an error has been detected in the power down save parameters saved in nonvolatile memory.	Perform a 1001 save in Pr mm.000 to ensure that the trip doesn't occur the next time the drive is powered up.
5	PSU: The PSU trip indicates that one or more internal power supply rails are outside limits or overloaded.	<ul style="list-style-type: none"> • Remove any option modules and perform a reset • Hardware fault within the drive – return the drive to the supplier
9	PSU 24V: The total user load of the drive and option modules has exceeded the internal 24 V power supply limit. The user load consists of the drive digital outputs.	<ul style="list-style-type: none"> • Reduce the load and reset • Provide an external 24 V power supply on control terminal 2 • Remove all option modules
253	Slot4 Not Fitted: The Slot4 Not Fitted trip indicates that the interface in slot 4 on the drive has been removed since the last power-up.	Hardware fault - Contact the supplier of the drive.
253	Slot App Menu: The Slot App Menu trip indicates that more than one option slot has requested to customize the application menus 18, 19, and 20. The sub-trip number indicates which option slot has been allowed to customize the menus.	Ensure that only one of the Application modules is configured to customize the application menus 18, 19 and 20
204 / 209 / 214	SlotX Different: The SlotX Different trip indicates that the option module in option slot X on the drive is a different type to that installed when parameters were last saved on the drive.	<ul style="list-style-type: none"> • Turn off the power, ensure the correct option modules are installed in the correct option slots and re-apply the power. • Confirm that the currently installed option module is correct, ensure option module parameters are set correctly and perform a user save in Pr mm.000
202 / 207 / 212	SlotX Error: The SlotX Error trip indicates that the option module in option slot X on the drive has detected an error. The reason for the error can be identified by the sub-trip number.	See relevant Option Module User Guide for details of the trip

Chiller Troubleshooting

Table 16. Trip Indications (continued)

Trip	Diagnosis	Recommended Actions
200 / 205 / 210	SlotX HF: The SlotX HF trip indicates that the option module in option slot X on the drive has indicated a hardware fault. The possible causes of the trip can be identified by the sub-trip number.	<ul style="list-style-type: none"> • Ensure the option module is installed correctly • Replace the option module • Replace the drive
203 / 208 / 213	SlotX Not Installed: The SlotX Not installed trip indicates that the option module in option slot X on the drive has been removed since the last power up.	<ul style="list-style-type: none"> • Ensure the option module is installed correctly. • Re-install the option module. • To confirm that the removed option module is no longer required perform a save function in Pr mm.000
201 / 206 / 211	SlotX Watchdog: The SlotX Watchdog trip indicates that the option module installed in Slot X has started the option watchdog function and then failed to service the watchdog correctly.	Replace the option module
226	Soft Start: The Soft Start trip indicates that the soft start relay in the drive failed to close or the soft start monitoring circuit has failed.	Hardware fault – Contact the supplier of the drive
221	Stored HF: The Stored HF trip indicates that a hardware trip (HF01 – HF17) has occurred and the drive has been power cycled. The sub-trip number identifies the HF trip i.e. stored HF.17.	Enter 1299 in Pr mm.000 and press reset to clear the trip
227	Sub-array RAM: The Sub-array RAM indicates that an option module, derivative image or user program image has requested more parameter RAM than is allowed. The RAM allocation is checked in order of resulting sub-trip numbers, and so the failure with the highest sub-trip number is given. The sub-trip is calculated as (parameter size) + (parameter type) + sub-array number.	
218	Temp Feedback: The Temp Feedback trip indicates that an internal thermistor has failed. The thermistor location can be identified by the sub-trip number.	Hardware fault – Contact the supplier of the drive
36	User Save: The User Save trip indicates that an error has been detected in the user save parameters saved in non-volatile memory. For example, following a user save command, If the power to the drive was removed when the user parameters were being saved.	<ul style="list-style-type: none"> • Perform a user save in Pr mm.000 to ensure that the trip doesn't occur the next time the drive is powered up. • Ensure that the drive has enough time to complete the save before removing the power to the drive.
40-89 / 112-159	User Trip: These trips are not generated by the drive and are to be used by the user to trip the drive through an application program.	Check the user program

Logical Flow Diagrams

The following section presents the simplified logical flow block diagrams for the principal systems in the SuperMod™ Water-Cooled Modular Chiller.

configurations to meet the demands of a worldwide market. The chiller is designed to operate with high voltage power supplied to the unit at all times. See [Figure 26, p. 71.](#)

High Voltage Logical Flow

SuperMod™ Water-Cooled Modular Chiller models are available in a range of voltage/amperage/phase

Figure 26. High voltage logical flow

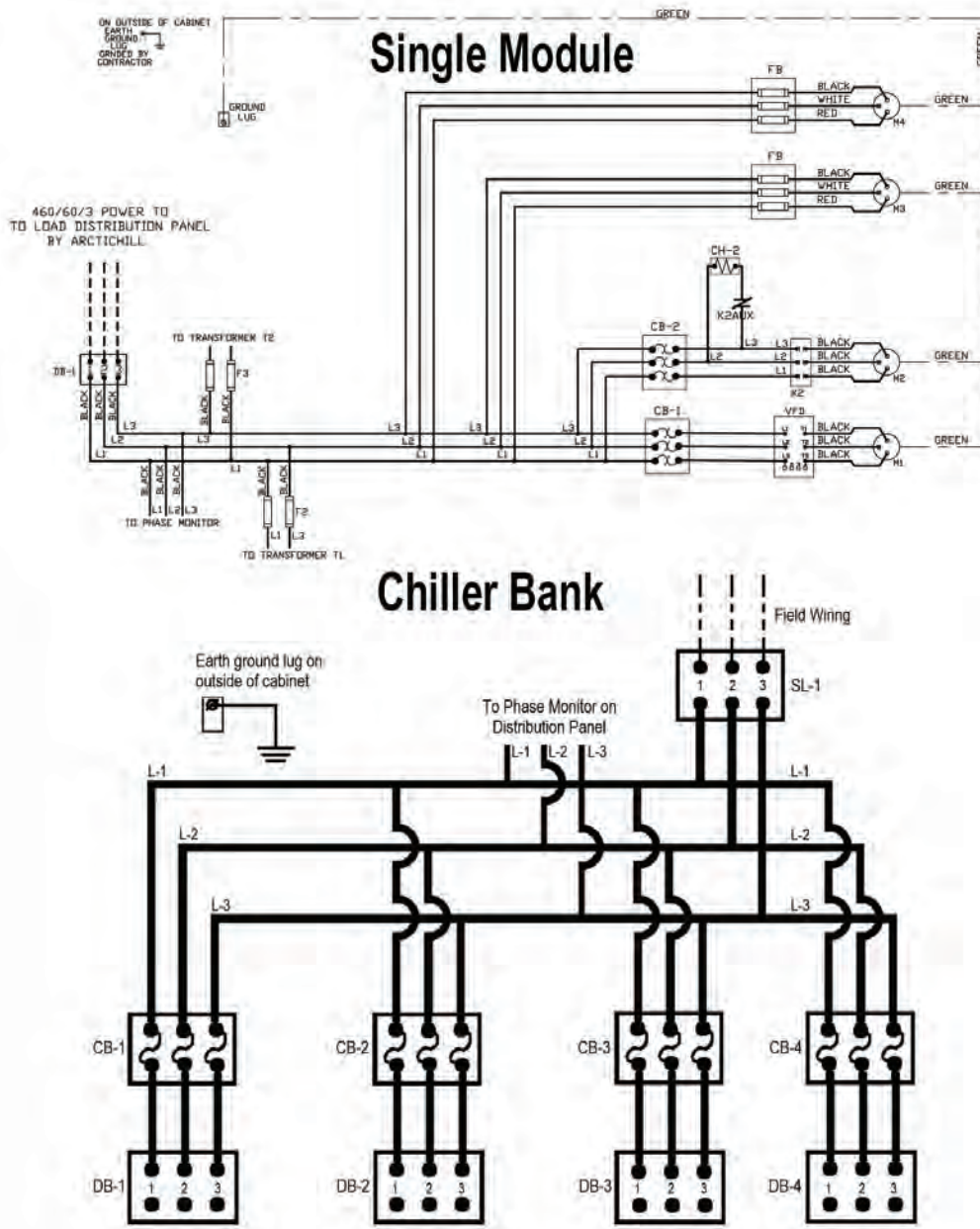

Control Logical Flow

The chiller uses low voltage for controller and sensor circuits. See following figure.

Figure 27. Control logical flow

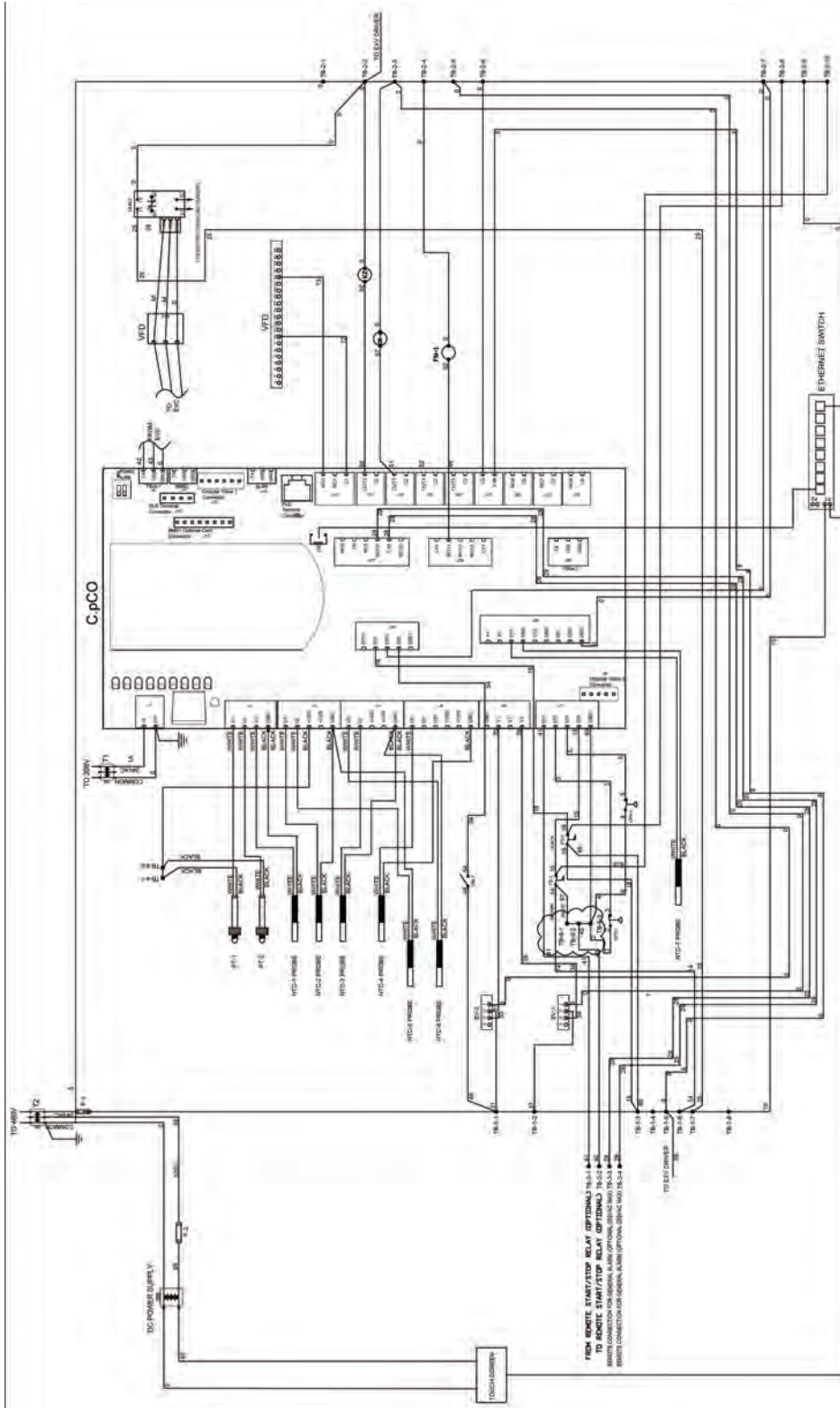
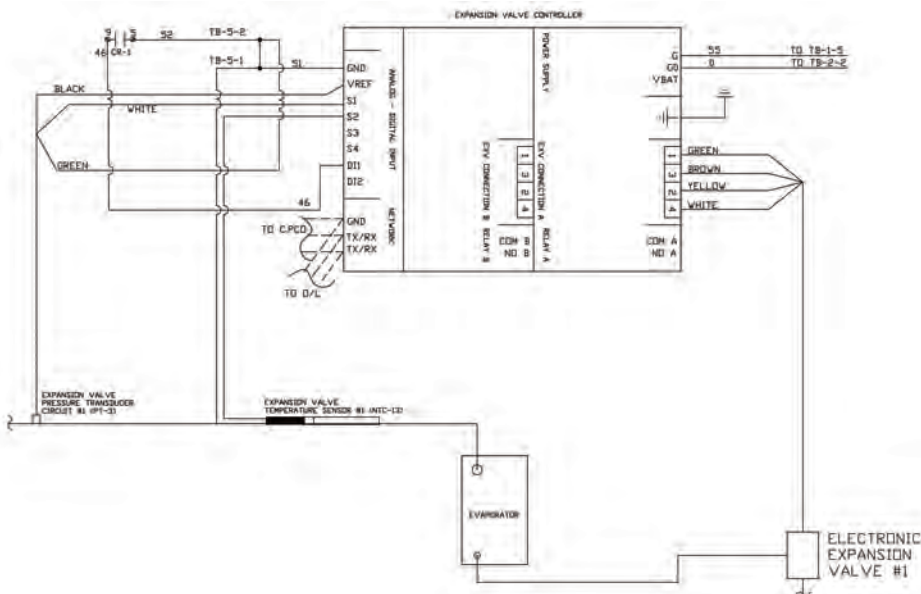

Figure 28. Expansion valve wiring



Refrigeration Logical Flow

The SuperMod™ Chiller uses one refrigeration circuits per module using tandem scroll compressor sets. See below figure.

The thermal capacity of the chiller modules is dependent on the leaving temperature of the chilled water, maintaining a minimum flow of water through the evaporator.

Figure 29. Refrigeration logical flow

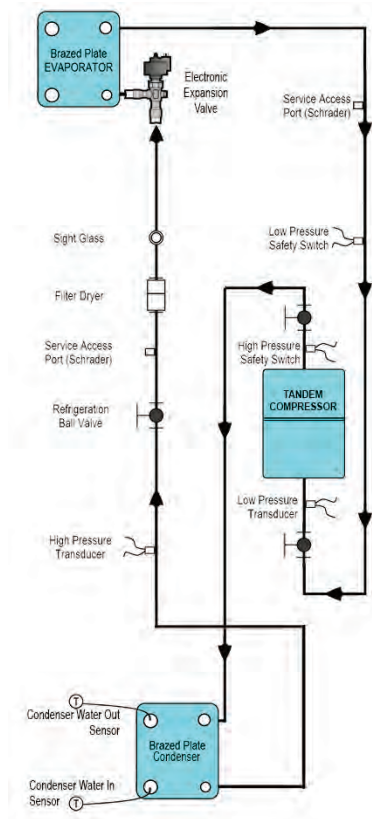

Water/Glycol Mixture Logical Flow

used within a closed system as shown in the following figure.

Trane recommends using a water/glycol mixture instead of an all water fluid. The water/glycol mixture is

Figure 30. Water/glycol mixture logical flow

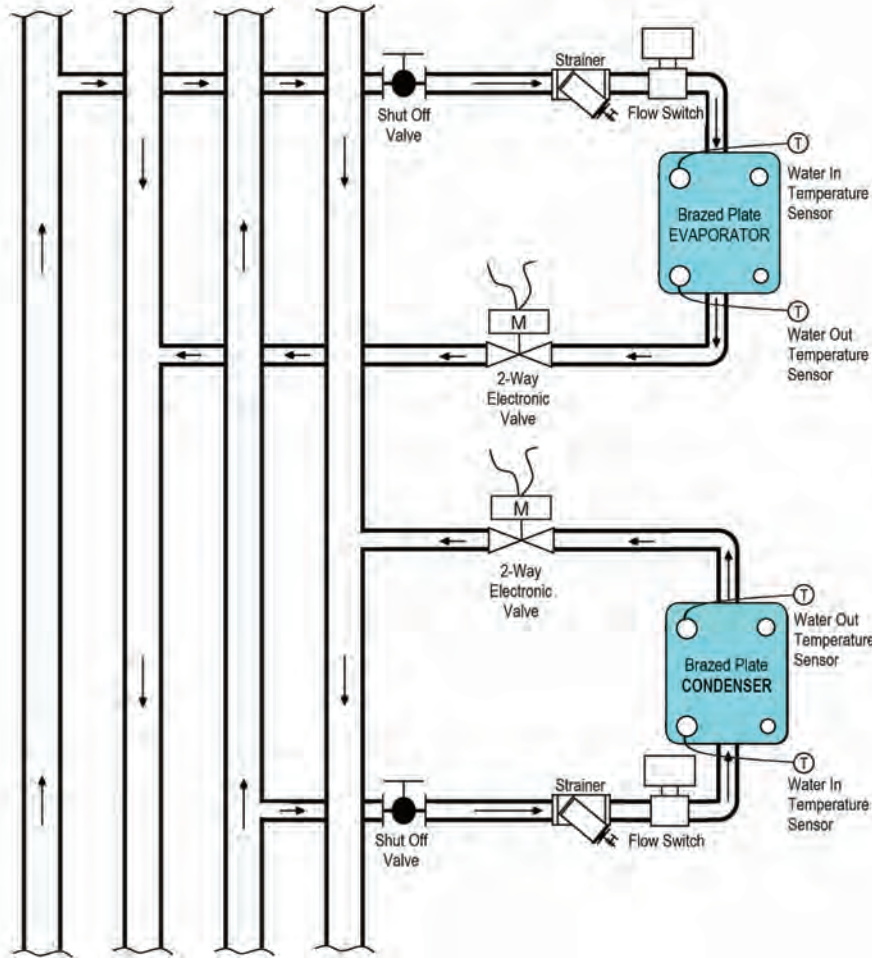



Appendix A. Acronyms and Abbreviations

All acronyms and abbreviations used in this manual, on the chiller controllers, and on module indicators and gauges are listed in the following tables.

Acronym List

All acronyms and abbreviations in this publication are listed in the following table, with their full spellings and expansions.

Table 17. Acronyms and abbreviations

Item	Expansion
410A	R410A
ACWS	Automatic City Water Switchover
AHRI	Air-Conditioning, Heating and Refrigeration Institute
AL	alarm
Alrms	alarms
Anlg	Analog
AO1	analog output one
Bd	board
btu	British thermal unit
C	Celsius
C1	Circuit 1
C2	Circuit 2
CB	Circuit Breaker
CE	Conformance European
ckt	circuit
CL	cool
Cntrl	Controller
Comps	Compressors
COND	condenser
CSA	Canadian Standards Association
DB	Dry Bulb
DB	Distribution Block
DifPr	Differential Pressure
Dly	Delay
DP	Differential Pressure
ECM	Electrically Commutated Motor
EER	Energy Efficiency Rating

Table 17. Acronyms and abbreviations (continued)

Item	Expansion
EMC	Electromagnetic Compatibility
EMI	Electromagnetic Interference
EPC	Extended Performance Compressor
EvapFl	Evaporator Flow
EVC	Electronic [expansion] Valve Controller
EXP1	Expansion Board 1
EXV	Electronic [expansion] Valve
F	Fahrenheit
FLA	Full Load Amperes
FLC	Full Load Current
FRECOOL	Free Cooling
FRI	Friday
gpm	gallons per minute
GUI	Graphical User Interface
HFC	Hydrofluorocarbon
HG	Hot Gas
Hotgas1	Hot Gas 1
HP	horsepower
HPS	High Pressure Switch
HT	heat
HVAC	Heating, Ventilation, and Air-Conditioning
ID	Inside Diameter
Ident	Identification
IEEE	Institute of Electrical and Electronic Engineers
IGBT	Insulated Gate Bipolar Transistor
INFO	Information
Int	Integration
IP	Industry Pack
Iso	Isolation
LA	Low Ambient
lbf	foot pounds
LBV	Load Balance Valve
LED	Light-Emitting Diode
LIFO	Last In First Out
LLS	Liquid Line Solenoid
LP	Low Pressure



Acronyms and Abbreviations

Table 17. Acronyms and abbreviations (continued)

Item	Expansion
LPPD	Low Pressure Pump Down
LPS	Low Pressure Switch
LRA	Locked Rotor Amperes
m	minute
Max	Maximum
Min	Minimum
MON	Monday
NEMA	National Electrical Manufacturers Association
NFPA	National Fire Protection Association
NTC	Negative Temperature Coefficient
OA	Outside Ambient
OAT	Outside ambient Air Temperature
OD	Outside Diameter
ORD	Open on Rise Differential pressure
ORI	Open on Rise Inlet pressure
P	Process
PD	Pressure Differential
PE	Protective Earth
PLC	Programmable Logic Controller
PMD	Panel Mounted Disconnect
POE	Polyolester Oil
ppm	parts per million
Pres	pressure
psi	pounds per square inch
PumpDown	Pump Down
PumpMod	Pump Module
PWM	Pulse Width Modulation
Pwrup Stg Up	Power Up Stage Up
REFRIG	Refrigeration
RemOff	Remote Off

Table 17. Acronyms and abbreviations (continued)

Item	Expansion
RMA	Returned Merchandise Authorization
Rot	Rotation
rpm	revolutions per minute
RP	Redundant Pump
s	second
SAT	Saturday
SDT	Saturated Discharge Temperature
SP	Set Point
SSS	Solid State Starter
SST	Saturated Suction Temperature
StartPt	Stating Point
SUN	Sunday
Sys	System
Temp	Temperature
TEMPS	Temperatures
THU	Thursday
TT	Twin Turbine
TUE	Tuesday
TXV	Thermal Expansion Valve
U1, U2	binary 1, binary 2
UL	Underwriters Laboratories
UV	Ultraviolet
VAC	Volts, Alternating Current
VDC	Volts, Direct Current
VFD	Variable Frequency Drive
WED	Wednesday
Y1, Y2	analog output: y1 = condenser
Y4	analog output



Appendix B. Request for Initial Startup

SuperMod™ Water-Cooled Modular Chiller

As part of a continuous commitment to quality, initial startup of this chiller by a factory-certified technician may be purchased from Trane. No initial startup will be scheduled without a Request for Initial Startup form completed and on file with the Trane customer service

department. Submitting this form indicates that all critical work described on the form has been completed. To prevent additional charges for aborted startups, the following items must be completely functional and operating and this form signed and returned to Trane at least 10 working days prior to the scheduled initial startup date.

Chiller/Heater Initial Startup Data

Model Number:	Primary Module Serial Number:
Primary Contact Name:	Primary Contact Phone:
Primary Contact FAX:	Primary Contact Mobile:
Name of Chiller Site:	
Physical Location of Chiller:	
Requested Date for Initial Start-up:	
Requested Time for Initial Start-up:	

Mandatory Initial Startup Requirements

Mandatory Tasks	Date Completed	Initialed Complete
All chiller modules are installed with minimum clearances available from all sides.		
Refrigeration gauges are indicating equal pressures.		
Chilled water lines from chiller to customer's equipment are permanently connected.		
Chilled water lines have been flushed clean of mud, slag, and other construction debris.		
All chilled water line filters and strainers are clean.		
Chilled water lines have been leak tested according to prestart instructions.		
Chiller reservoir (if included) is at operating level with correct water/glycol mixture.		
High voltage wiring is installed, tested, and functional.		
All water, refrigeration, electrical, and control connections between chiller modules are completed.		
All control wiring between modular chillers is installed, tested, and functional.		
Control wiring is complete, including any remote interface panel or special-purpose module wiring.		
Automatic City Water Switchover (if included) is installed, flushed, and leak-tested.		
Condenser, if applicable, is installed, piped, wired, and leak-tested.		
All responsible installing contractors and sub-contractors are notified to have representatives available on site to provide technical support for the initial start-up procedure.		
Full load shall be available for chiller on the initial start-up date.		



Request for Initial Startup

Initial Startup Agreement

By signing this form, you agree the chiller is ready for initial startup. It is understood that, if the chiller is not ready for initial startup due to site problems, the initial startup will be aborted at the discretion of the

designated startup technician. Payment for an aborted startup will be forfeited. Rescheduled initial startups are subject to any additional costs that may have been incurred by the technician. An approved purchase order or payment in advance will be required to reschedule an aborted initial startup.

Name (Printed): _____

Date: _____

Signature: _____

Company: _____

Trane creates comfortable, energy efficient indoor environments for commercial applications. For more information, please visit trane.com or americanstandardair.com.

Arctic designs cost-efficient leading-edge chillers and applied solutions to meet individual customer needs—from large, medium to smaller-scale systems. For more information, please visit www.arcticchillergroup.com.

Trane has a policy of continuous product and product data improvement and reserves the right to change design and specifications without notice. We are committed to using environmentally conscious print practices.