



Product Catalog

Tracer[®] SC⁺ System Controller with the Tracer[®] Synchrony User Interface





Introduction

Tracer SC+, the next generation building controller, features a faster processor for increased space for custom graphics, data logs and applications. Tracer SC+ is accompanied by the Tracer Synchrony user interface, which combines performance and function.

Tracer Synchrony features include:

- Customization of the log in screen (apply a custom graphic)
- Expansion module management and point referencing
- USB port management
- Backup and restore — restore backups from earlier version of Tracer SC to Tracer Synchrony

Copyright

This document and the information in it are the property of Trane, and may not be used or reproduced in whole or in part without written permission. Trane reserves the right to revise this publication at any time, and to make changes to its content without obligation to notify any person of such revision or change.

Trademarks

All trademarks referenced in this document are the trademarks of their respective owners.

Revision History

Updated Controller specifications Table in Specifications Chapter.



Table of Contents

Product Overview	5
Tracer Building Automation Systems	5
Tracer SC+ System Architecture	6
Tracer Communication Bridges	6
Tracer SC+ Facilities	7
The User Interface	9
Alarms	10
Data Logs	10
Schedules	11
Overrides	12
Reports	13
Graphical and Bindable Widgets	14
Graphics and The Tracer Graphics Editor	14
The Navigation Tree	16
User Security	16
Remote Access to a Tracer BAS	17
System Control	19
Applications	19
Area Application	19
Trim/Respond Setpoint Reset Logic	19
Linear Reset	20
Chiller Plant Control (CPC) Application	20
Variable Air Systems (VAS) Application	21
Demand Management Application	21
Tracer Graphical Programming (TGP2)	21
Unit Control	23
BACnet® (MS/TP) Unit Controllers Supported by Tracer SC+	23
BACnet IP Unit Controllers Supported by Tracer SC+	23
Air-Fi® Wireless Unit Controllers Supported by Tracer SC+	23
LonTalk® Unit Controllers Supported by Tracer® SC+	23
Trane Legacy Unit Controllers (Comm3/4) Supported by Tracer SC+	23
Resources	25
Specifications	26



Table of Contents

Hardware Components	29
Tracer® SC+ Components	29
Dimensions	30
Tracer® SC+ Power Supply	30
Tracer BACnet Terminator	32
Medium/Large Enclosure (Optional)	32
Large Enclosure (Optional)	32



Product Overview

Tracer SC+ allows you to streamline facility management without reinventing the entire system. Adding Tracer SC+ to your system provides a flexible, cost effective solution for building automation, and managing the facility climate that can extend to lighting and energy consumption.

Accessible from most PCs, tablets, and smart phones, the Tracer Synchrony user interface eliminates the need for a dedicated computer and monitor so you can manage system performance whenever and wherever it is convenient. The intuitive online tools provide improved efficiencies, increased tenant comfort and reduced energy costs, which result in operational cost-savings and a better bottom line.

	<p>Occupant comfort and energy savings</p> <ul style="list-style-type: none"> Tracer SC+ includes several factory engineered HVAC applications that have been developed by HVAC system experts and tested on tens of thousands of facilities to ensure that your facility operates at its peak performance. These applications provide consistent comfort and improved indoor air quality, while reducing energy requirements. Tracer Graphical Programming (TGP2) is a powerful graphical program that can be used to customize factory applications or control non-HVAC equipment.
	<p>Access your facility from anywhere</p> <ul style="list-style-type: none"> Tracer Synchrony is web-enabled and accessible from virtually any device with a web browser. All of the most popular device types, operating systems, and browsers are supported. The Tracer BAS Operator Suite is a mobile app that allows you to monitor and manage buildings from virtually anywhere, giving you greater freedom and constant peace of mind. Trane Connect for Remote Access provides an easy, secure option for remotely connecting to a Tracer SC+.
	<p>Support for open, standard protocols</p> <ul style="list-style-type: none"> Open, standard protocols are the key to enabling communication among Trane and non-Trane HVAC equipment, as well as other complementary facility systems. These protocols enable communication across systems and vendors to ensure that your building operates at its best on day one and beyond. Tracer SC+ natively communicates to BACnet® and LonTalk controllers and is listed as a BACnet Building Controller (B-BC) by BACnet Test Labs (BTL). Tracer SC+ supports Trane Air-Fi® Wireless, providing standard wireless BACnet Zigbee™ building automation between Trane BACnet controllers and zone sensors.
	<p>Support for Trane Air-Fi® Wireless</p> <ul style="list-style-type: none"> Trane Air-Fi Wireless brings maximum flexibility to your building automation system. For contractors, it significantly simplifies building controls projects by minimizing the engineering, estimating and project management tasks associated with communication link. For building owners, it provides easier and more cost-effective controls upgrades and building expansion projects. Trane technology helps prepare your facilities for the future of building information. Trane Air-Fi Wireless runs BACnet protocol over ZigBee building automation standards. Trane Air-Fi is the first HVAC manufacturer to be Zigbee Certified.

Tracer Building Automation Systems

From our industry-leading building automation systems to equipment controls and sensors, Trane offers a complete controls portfolio to enable you to operate buildings at peak energy and operational efficiency.

Trane controls are built on open, scalable platforms. They provide options to integrate with your existing equipment and controls, regardless of brand, and give you the latitude to easily expand into other systems within your building, multiple buildings and buildings you'll add in the future.

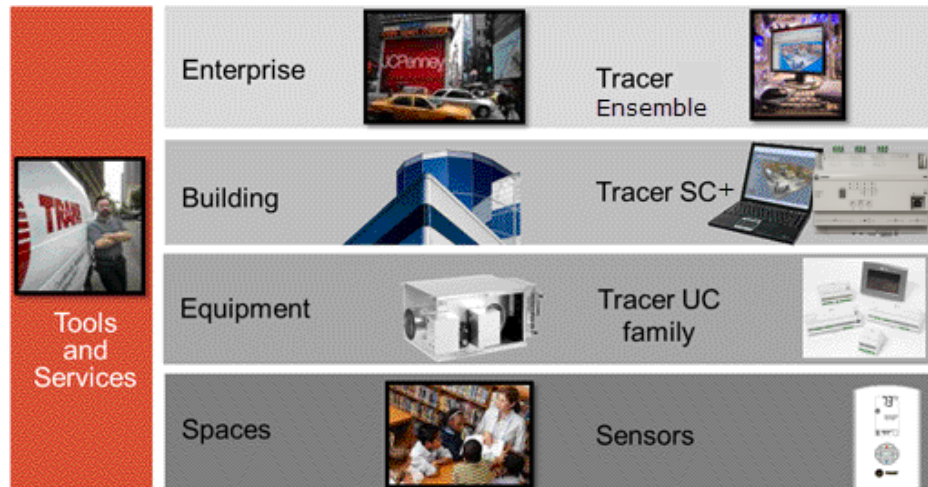

Tracer SC+ System Architecture

Tracer SC+, along with the Tracer Synchrony user interface, is at the heart of a Tracer building automation system. Tracer Synchrony provides a web-based front end for your facility that can be accessed with most PCs, tablets and smart phones. Tracer SC+ includes powerful, factory-engineered applications that are designed to provide the perfect balance of energy efficiency and user comfort. Tracer SC+ communicates with a variety of Trane and non-Trane controllers using open, standard protocols, including BACnet, LonTalk, and Modbus. A diagram depicting the high-level system architecture is shown in the following figure.

Figure 1. Tracer BAS structure (PC/tablet/phone with web browser)

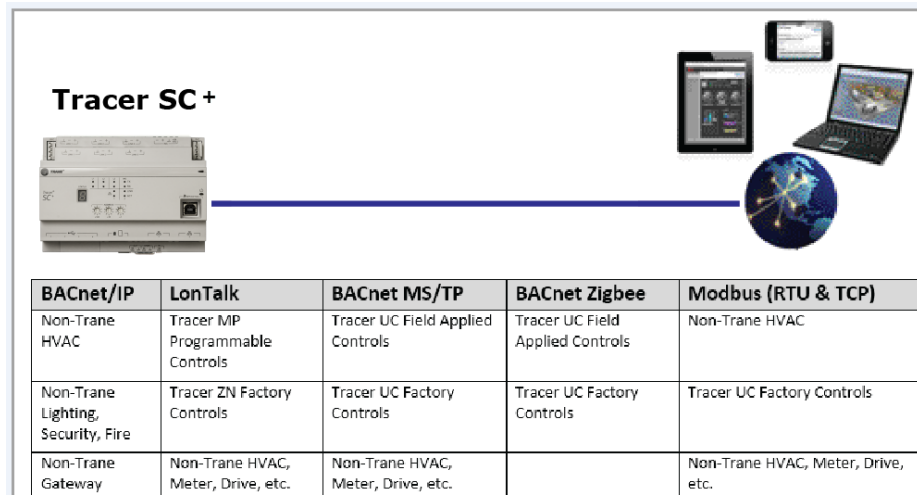

Tracer Communication Bridges

Tracer Communications Bridges integrate legacy control products into current Tracer systems for monitoring and control purposes.

Tracer Communications Bridges use legacy communications protocols to access points stored in previous-generation field-level controllers. The Bridges then convert the points to BACnet objects and

properties, which makes them available for system use through the BACnet IP communications protocol.

Comm2 to BACnet IP

This bridge is used to integrate up to three UCP1-controlled chillers (CenTraVac and Series-R) into Tracer systems for monitoring and control purposes. For more information, refer to the *Comm2 to BACnet IP Product Data Sheet*, (BAS-PRC070).

Tracer SC+ Facilities

A Tracer SC+ facility is defined as a collection of one or more Tracer SC+ controllers. A single building or campus can contain more than one Tracer SC+ facility.

An Application or App SC+ is a Tracer SC+ controller that has had one or more "Application Licenses" applied to it. The typical deployment of an App SC+ is for actively controlling a system.

A Base SC+ is a Tracer SC+ controller that has not had an "Application License" applied to it. The typical deployment of a Base SC+ is for passively monitoring a system (through web UI or Trane Intelligent Services) OR adding capacity to a Multi-Tracer SC+ facility.

A Single Tracer SC+ facility has the following characteristic:

- It is either an App SC+ or a Base SC+.

A Multi-Tracer SC+ facility has the following characteristics:

- It can have at most one App SC+.
- It can optionally have one or more Base SC+s.
- It can support a maximum of 240 controllers, although the practical limitation may be lower due to the combination of Tracer SC+ controllers and protocol.

The following table shows the maximum device capability for the communication type and the facility type. However, observe the following when configuring your facility:

- Do not exceed Individual link limitations
 - BACnet MS/TP 60 per link (App or Base Tracer SC+)
 - Modbus® RTU 30 per link (App SC+ only)
 - LonTalk® 120 per link (App SC+ only)
- Three links can be configured as BACnet MS/TP or Modbus RTU
- Do not exceed the maximum of 240 total devices per facility

Note: In a Multi-Tracer SC+ installation, LonTalk, Modbus TCP, and Modbus RTU controllers must all be installed in the App SC+.

Table 1. Device capability

Communication Type	Single SC+	Multi SC+
Air-Fi® Wireless	Up to 120 devices	Up to 240 devices
BACnet MS/TP	Up to 180 devices	Up to 240 devices
BACnet/IP	Up to 240 devices	Up to 240 devices
BACnet/SC	Up to 240 devices	Up to 240 devices
COMM 3/4*	Up to 240 devices	Up to 240 devices
LonTalk	Up to 240 devices (when using two Tracer USB LonTalk modules)	Up to 240 devices (when using two Tracer USB LonTalk modules)**
Modbus TCP	Up to 240 devices	Up to 240 devices**
Trane VRF (XML/IP)	Up to 240 devices	Up to 240 devices**
Modbus RTU	Up to 90 devices	Up to 90 devices**
* A BMTB is required for communication to COMM 3/4		
** Must be installed on the Application SC+		

Note: Trane Air-Fi® sensors do not count against the device limits listed above. For more information, see the Air-Fi Wireless System IOM Manual, (BAS-SVX40-EN).*

Figure 2. Example of a single SC+ facility configuration

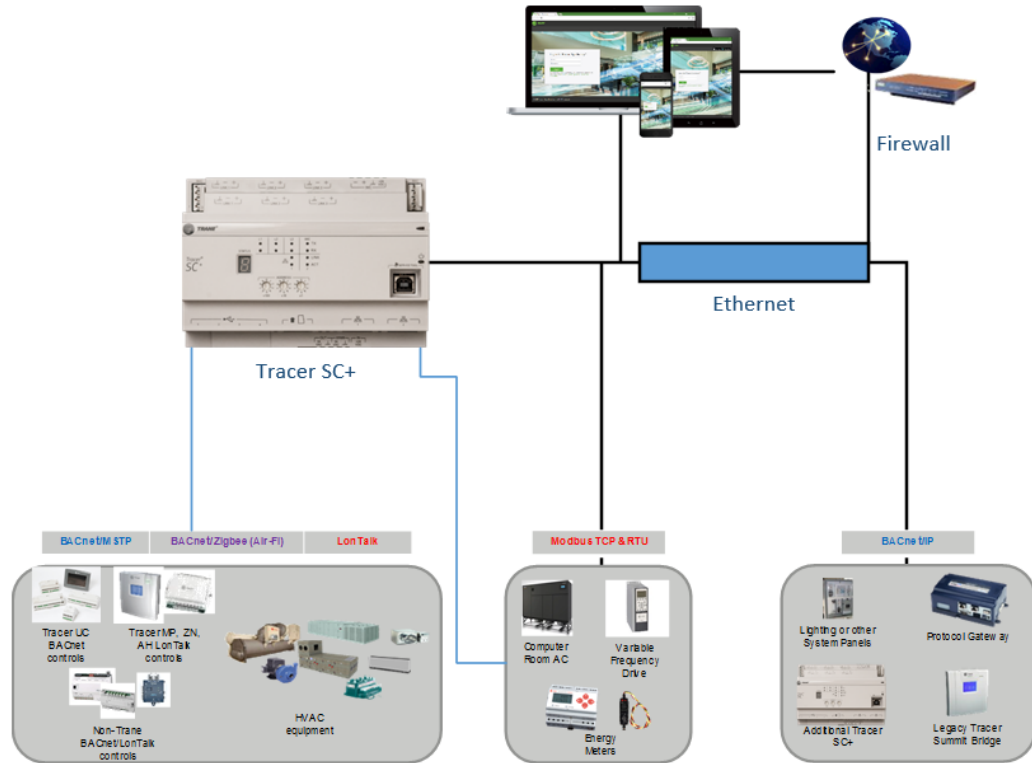

The User Interface

The Tracer® Synchrony user interface provides an easy way for users to set up, operate, and modify a building automation system. The home page contains system status information and links to navigate to all areas of the system. The navigational elements are described in the following table.

Table 2. Navigating the user interface



Number	Button/Menu Functions	Description
		
1	Global Navigation Bar	<p>This is visible on every page. From left to right, the bar contains:</p> <ul style="list-style-type: none">  (User) — Click to logout, view or edit preferences, or change your password. Favorites —Click this button to save frequently Tracer Synchrony UI pages. Home —Click this button at anytime to return to your home page. Alarms —Shortcut to the Alarms page. If a new alarm or event has been detected by the system since the Alarms page, the Alarms icon flashes. Admin... Provides access to roles and users. <ul style="list-style-type: none"> Appears only if the user has administrative privileges. A role is a collection of access rights to equipment, functions, and applications. Users are assigned to roles. The role assignment determines a user's access rights. Six pre-defined user roles exist in the Tracer SC+. These roles can be used as is, or as a basis to create additional roles. Roles define the extent to which a user is allowed to perform specific functions. Each user is assigned a role. If you make a change to a role, all users assigned to that role will have their permissions changed, as prescribed by the updated role.  — Click to open a help topic that pertains only to the information on the page in view. When the help topic is opened, click "show" to access the entire Tracer Synchrony help system.
2	Outdoor Conditions	Shows current outdoor temperature and humidity.
3	Internal Scroll Bar	An internal scroll bar is available for pages that contain long lists of data and multiple sections.

Table 2. Navigating the user interface (continued)

Number	Button/Menu Functions	Description
4	Left Navigation Menu	Contains a list of menu items that are linked to features, applications, and equipment.
5	Navigation Tree	A customized view of user-selected elements in the HVAC system. You can group, order, name elements, and assign custom graphics to the tree nodes according to your preferences.

Alarms

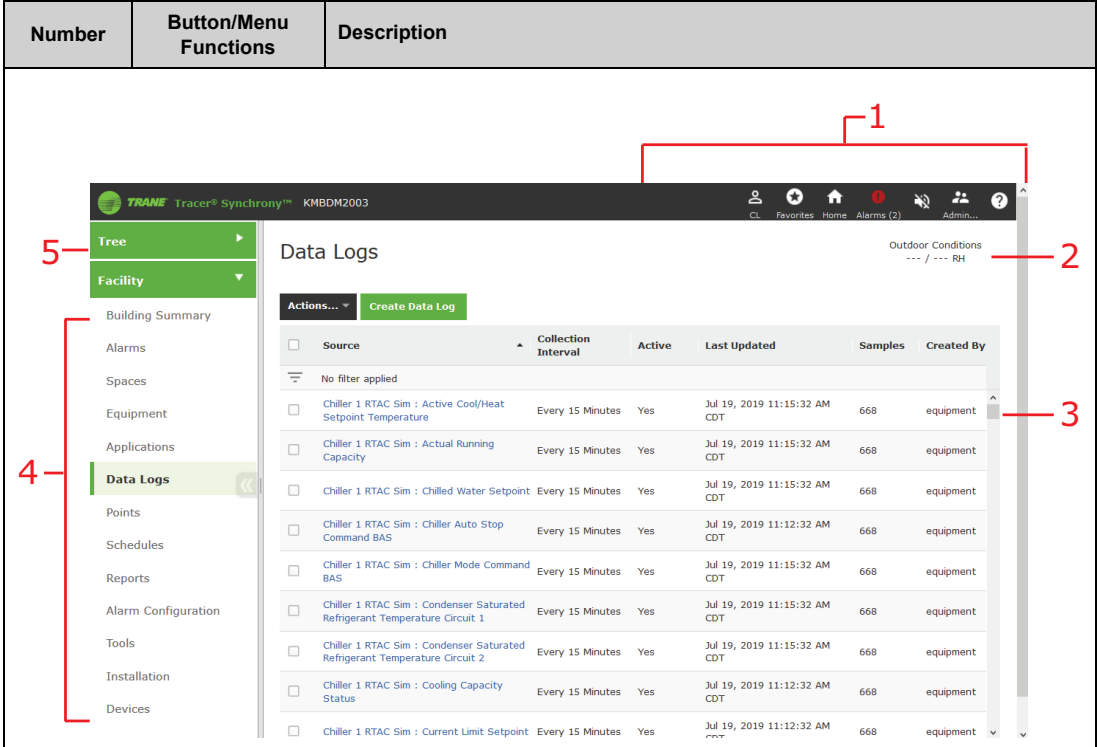
The alarm handling capabilities of Tracer SC+ allow users to receive, view, acknowledge, and make comments on building alarms and events. BACnet standard requires alarms and events. An alarm is used to indicate an abnormal condition such as a sensor failure. An event is something that is expected to happen in a system, such as a chiller shutting down because it was no longer needed. Trane Tracer uses categories to classify the alarms; however, third party BAS systems still use the events. If a critical alarm exists an alarm icon flashes in the global navigation bar, which remains visible in the right corner of every page on the user interface.

The Unsuppressed Alarms tab contains a list of all unsuppressed alarms that have been detected by the system. Data displayed includes when and where the event occurred and whether operator acknowledgment is required. The Suppressed Alarms tab lists all unnecessary alarms that are suppressed. Suppressed alarms will not be annunciated or routed to e-mail recipients.

Figure 3. Alarms log

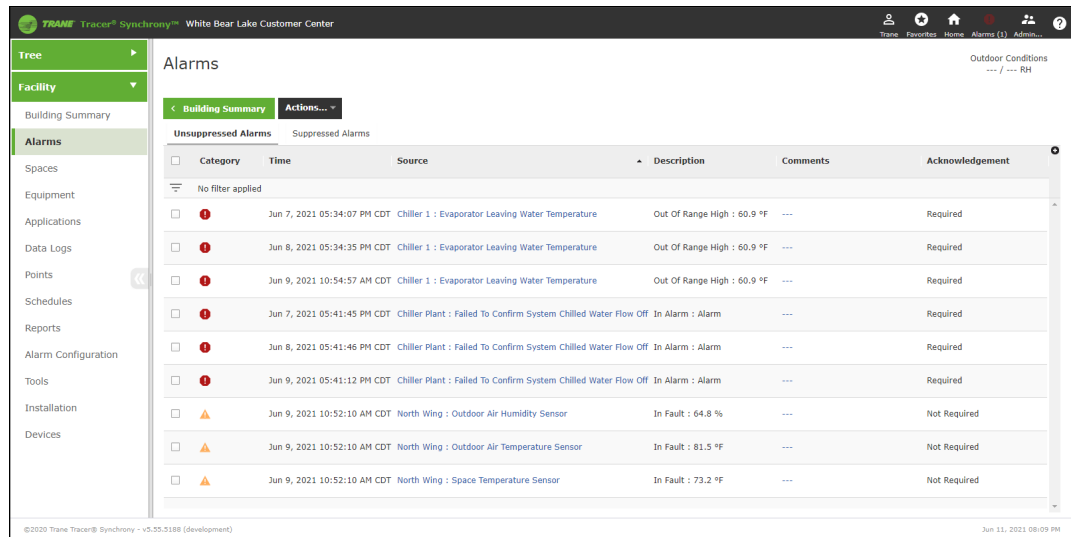

Data Logs

Data Logging, also referred to as trending, records in real-time the value of a data point in the system and the time at which the value was recorded.

By default, Tracer® SC+ automatically generates system-created data logs (for equipment and standard applications) on a 15-minute interval and then stores that data for seven days. Data storage is a continuous window where only the most recent seven days of data are stored. Data older than seven days is discarded in order to make room for the newest data.

Users can also create interval (either scheduled or triggered) or change of value data logs by clicking the log data button on equipment and applications pages or by using the create data log wizard from the Data Logs section.

A list of data logs can be accessed by clicking **Data Logs** from the left navigation menu. From this page you can take action on a data log, such as comparing or exporting, by selecting one or more data logs and then clicking the **Actions** button.

Figure 4. Data logs page

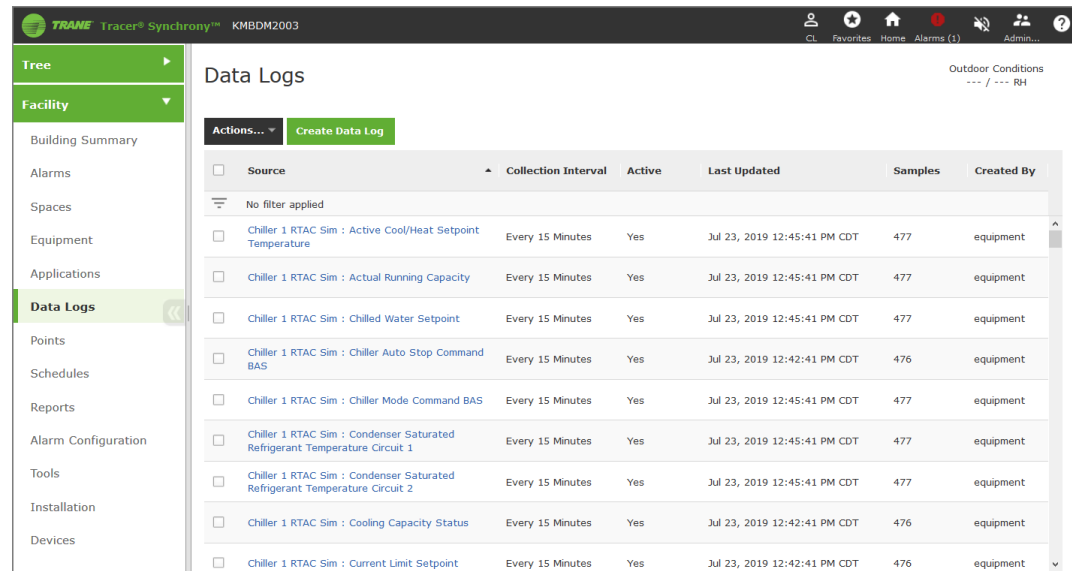

Schedules

Scheduling for Tracer SC+ is based on the BACnet schedule object implementation. Scheduling is one of a facility's most important energy-saving strategies. It ensures that equipment runs only when needed. Scheduling facilitates the following tasks:

- Creating, editing, and deleting schedules
- Creating, editing, and deleting calendars and exception schedules
- Viewing all effective schedules in a facility

The Schedules page contains four tabs: Active Schedules, All Schedules, All Exceptions, and All Calendars.

Figure 5. All Schedules (Active shown)

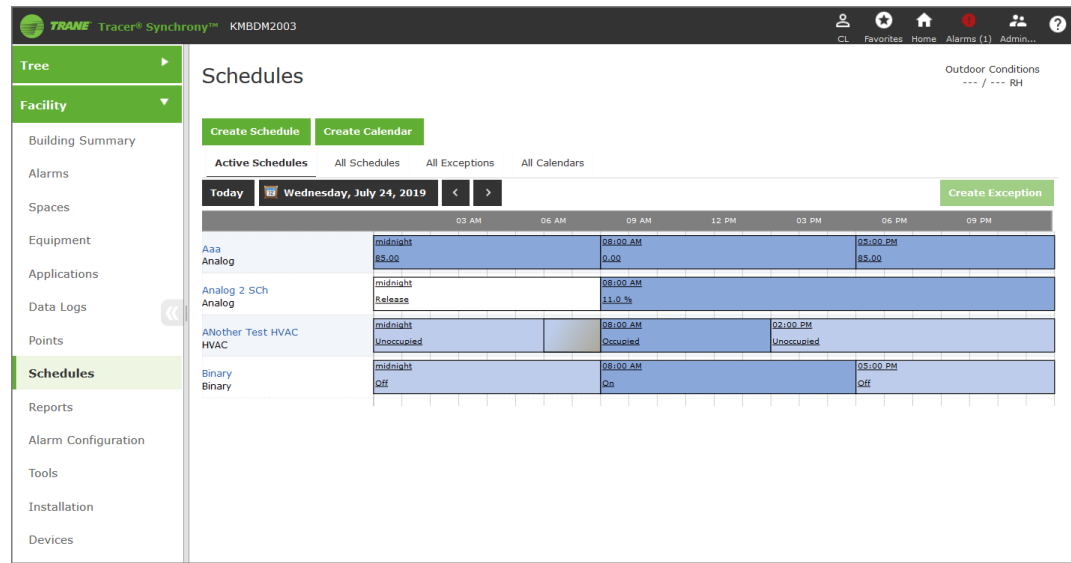

Overrides

A typical challenge that facility managers have is maintaining the balance between automatic and manual system control. Tracer SC+ provides multiple methods of overriding equipment, applications, and points while also ensuring that the proper balance of automatic and manual system control is kept. These methods include:

Permanent Overrides

The most typical use of a permanent override is through applications. Tracer SC+ provides the ability to determine which user or application has performed an override to quickly determine who has overridden a setpoint.

Temporary Overrides

A common challenge in facilities is inadvertent overrides. Tracer SC+ provides a default override option for users, which allows an override to expire after a period of time. This ensures that temporary overrides do not inadvertently become permanent overrides.

All items in Override Report

It can be difficult to track down overrides that have become permanent and are causing a facility to act differently than a facility manager expects. Tracer SC includes a standard report that allows a user to quickly identify all points within the system that have been overridden. See the following figure.

Figure 6. All Items in Override Report

Name	Owner Name	Value	Priority	Owner Name	Last Control Time	Value Description
Chilled Water Valve Status	Blower Coil - Loading Dock	0.0 %	9	cool_vlv_modTriac	Nov 29, 2017 03:01:31 PM CST	...
Cool Valve Request	Blower Coil - Loading Dock	0.0 %	9	cool_vlv	Nov 29, 2017 03:01:26 PM CST	...
Space Temperature Setpoint Active	Blower Coil - Loading Dock	72.5 °F	9	common	Nov 29, 2017 03:01:34 PM CST	...
Outdoor Air Temperature Active	Blower Coil - Loading Dock	-1,768.0 °F	9	common	Nov 29, 2017 03:01:34 PM CST	...
Filter Runtime Hours	Blower Coil - Loading Dock	11,787.21	9	1speedFan	Nov 29, 2017 03:01:31 PM CST	...

Reports

You can generate the following types of reports for Trane equipment:

- Site reports
- VAS commissioning reports
- Points reports
- Chiller reports

Report features include:

- Scheduling reports to run during specific date periods and run frequencies
- Specifying file storage options for scheduled reports
- Exporting reports to save to your PC as CSV, HTML, or PDF files
- Editing scheduled reports

Figure 7. Reports page

Title	Type	Date and Time of Run
All Items in Override Report	All Items in Override	Nov 29, 2017 03:00:52 PM CST
Site Commissioning Report	Site Commissioning	Nov 29, 2017 03:00:08 PM CST
All Items in Alarm Report -MEM_812	All Items in Alarm	Nov 29, 2017 08:00:08 AM CST
All Items in Alarm Report -MEM_811	All Items in Alarm	Nov 28, 2017 08:00:07 AM CST
All Items in Alarm Report -MEM_810	All Items in Alarm	Nov 27, 2017 08:00:05 AM CST
All Items in Alarm Report -MEM_809	All Items in Alarm	Nov 23, 2017 08:00:02 AM CST
All Items in Alarm Report -MEM_808	All Items in Alarm	Nov 22, 2017 08:00:00 AM CST

Graphical and Bindable Widgets

Graphical and bindable widgets can be incorporated into Tracer SC+ custom pages. Graphical widget components provide a visual representation of an analog process such as the current temperature or the current level of a water tank. Bindable widgets provide control and display of system controls and states in a simplified way. The following figure provides an example of each.

Figure 8. Widget examples (A. Graphical, B. Bindable)

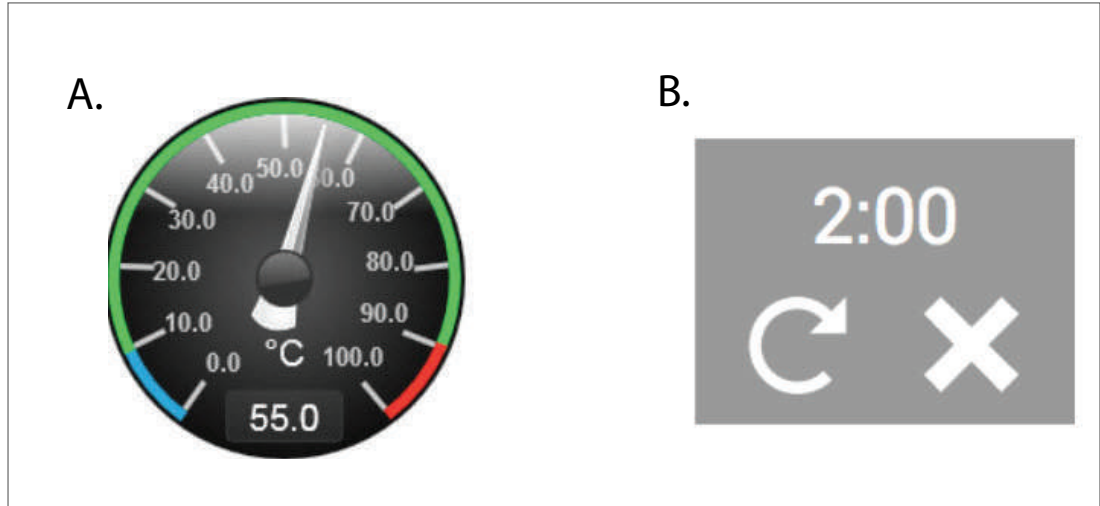

Graphics and The Tracer Graphics Editor

With the Tracer Graphics Editor (TGE), available through the Tracer TU service tool, users can create, edit, and publish graphics for use on Tracer Synchrony. Graphics on Tracer Synchrony monitor and control building equipment and applications. They can display data related to climate, lighting, and other controllable operations. They can be used to change setpoints and to override equipment operation.

TGE can be used to align graphical elements, determine which elements appear on top, and perform cut, copy, and paste functions.

Graphics can include:

- Data from external websites — including weather data, documents and other information.
- Any data that is available in the system as a numerical or text value
- Analog values that can change colors if they deviate from a desired value
- Multiple graphic images in JPEG, GIF, and animated GIF formats
- Visual elements from the building, such as floor plans or exterior views from CAD drawings
- Digital photography in JPG and GIF formats
- Animated images to represent binary and analog values
- Target buttons that provide links to related sources
- User controls including push buttons, check boxes, drop-down list boxes, and entry fields

Graphics can be grouped in a logical way to simulate navigation through the building automation system. See the following figures for examples.

Figure 9. Tracer Synchrony home page with building exterior graphic (example 1)

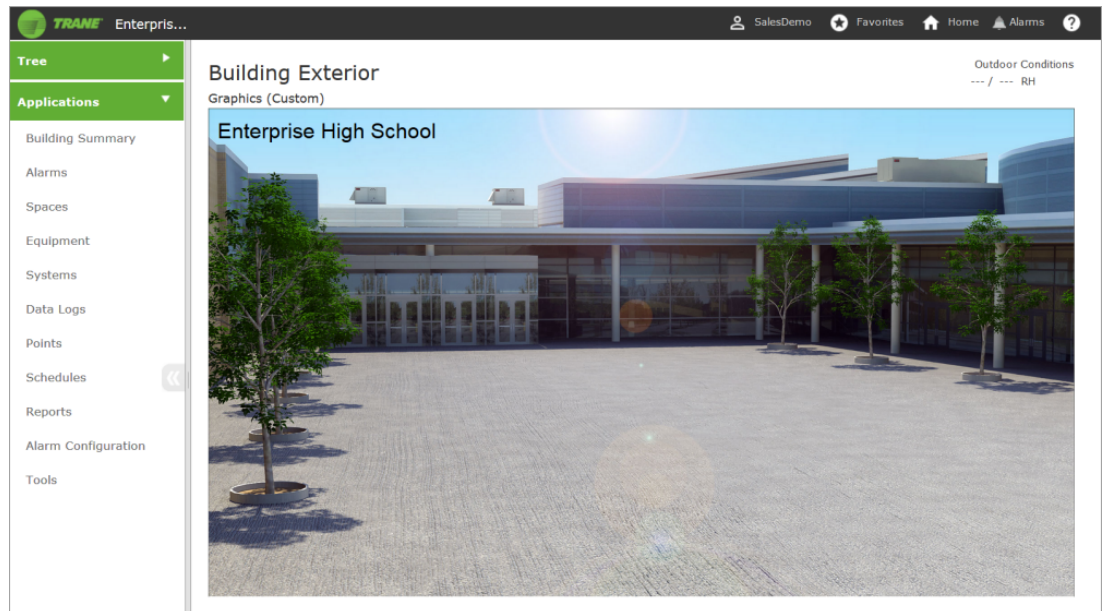

Figure 10. Tracer Synchrony home page with floor plan graphic (example 2)

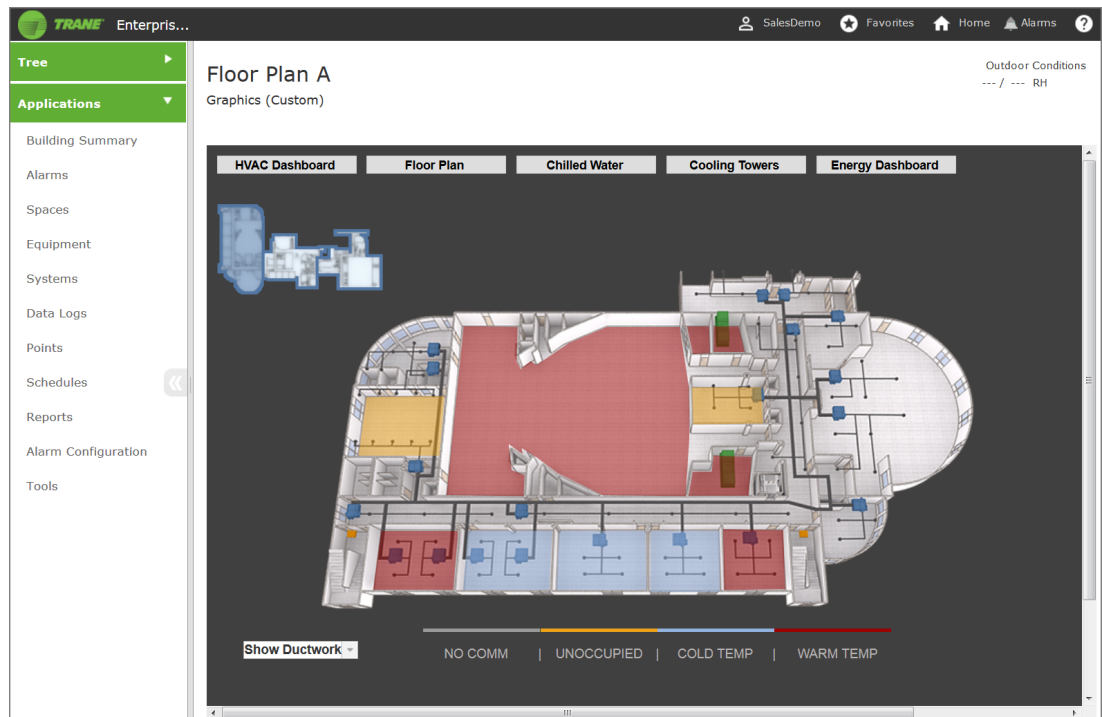
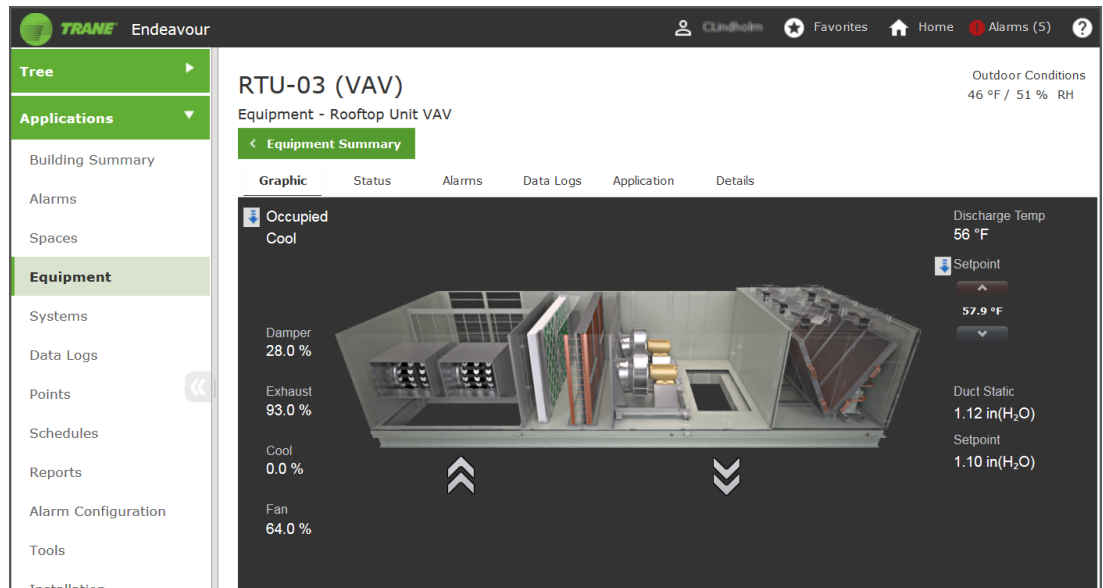

Figure 11. Equipment status graphic (example 3)



The Navigation Tree

The navigation tree contains the logically ordered and grouped content of all the elements of your HVAC system. The navigation tree populates automatically when spaces, systems, points, and equipment are installed. A navigation tree provides an alternate way to navigate through the user interface. The navigation tree consists of nodes, display text, and icons. You build the tree by choosing display text for nodes, arranging the nodes, and assigning associated graphics. The graphics represent equipment and areas of the facility.

Figure 12. The navigation tree

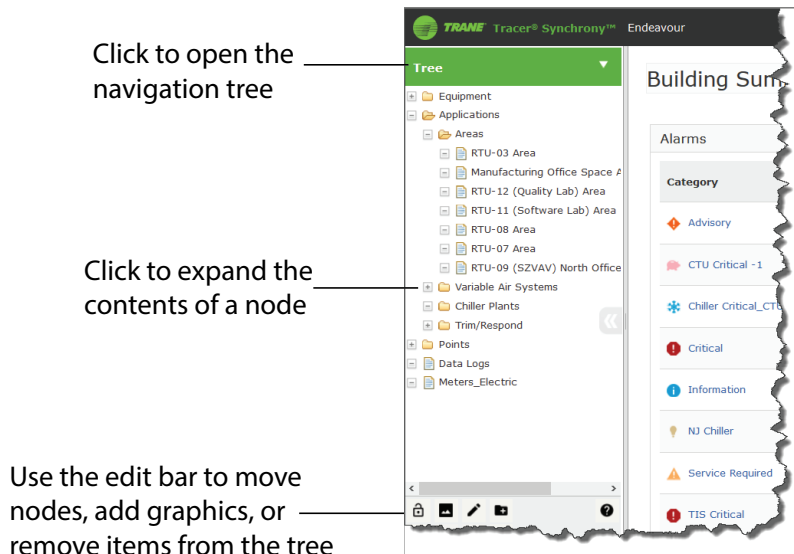

User Security

A sophisticated password system protects a Tracer system from unauthorized access. Password strength criteria is editable and can be tailored to meet security requirements.

Figure 13. Password requirements

Security

The following security settings apply to all user profiles.

▼ Password Requirements

Password Requires Mixed Case: ✓

Password Requires Number: ✓

Password Requires Symbol: ✓

Password May Not Contain User Information: ✓

Password Minimum Length:

Number Of Previous Passwords Blocked From Reuse:

Enforce Password Expiration

Days Until Expiration:

Operators are assigned a role, which defines their access rights.

- Operators have access only to those features that are defined in their roles.
- Several predefined roles can be selected from Tracer SC+ and roles can also be customized.
- An operator with administrative-level security can manage users and roles and has the ability to reset passwords.

Figure 14. Tracer SC+ user roles

Roles

Outdoor Conditions
--- / --- RH

Actions...
Create Role

<input type="checkbox"/>	Name	Description
<input type="checkbox"/>	Installer/Programmer	Installs and configures system equipment and program functions, modifies points and other system objects, and can override most equipment and application setpoints.
<input type="checkbox"/>	Building Operator	Acknowledges alarms, responds to building occupant requests, creates and modifies schedules, and can override most equipment.
<input type="checkbox"/>	Facility Manager	Configures and runs schedules, data logs, and standard reports that are used as tools for budgeting and planning.
<input type="checkbox"/>	Advanced Building Operator	Acknowledges alarms, responds to building occupants requests, creates and modifies schedules, data logs, and standard reports.
<input type="checkbox"/>	Remote Building Operator	Responds to and acknowledges alarms and space comfort requests from occupants, and creates and modifies schedules.
<input type="checkbox"/>	Tenant	Views the alarm log and data logs, operates the building light functions, and has full scheduling capabilities.
<input type="checkbox"/>	Trane Concierge	Intended for use with Tracer Concierge display. Configure schedules, override most equipment and application setpoints. Similar to the Installer/Programmer role.
<input type="checkbox"/>	Trane Concierge without Schedules	Intended for use with Tracer Concierge display for National Accounts. No access to schedules. Override most equipment and application setpoints.

Remote Access to a Tracer BAS

Trane recommends using Trane Connect Remote Access, a pre-engineered, secure IT technology. For more information about Trane Connect Remote Access, refer to the *Intelligent Services Software Interface User Guide*, (BAS-SVU22). If the Tracer BAS does not have access to the internet, a Trane Cellular Router or Trane USB Cellular Module can be used. For more information on the cellular router



The User Interface

solution, including ordering information and remote access, refer to the *Trane Cellular Router Installation, Operation, and Maintenance Guide*, (BAS-SVX067). For more information on the Trane USB Cellular Module solution, refer to the *Trane USB Cellular Module Installation Instructions*, (BAS-SVN213).



System Control

Tracer SC+ includes a powerful system control engine. Every Tracer SC+ ships with several factory engineered HVAC applications, support for Trane Earthwise™ Systems, and a powerful custom graphical programming language.

Applications

Tracer SC+ includes a powerful system control engine. Every Tracer SC+ ships with several factory engineered HVAC applications, support for Trane Earthwise™ Systems, and a powerful custom graphical programming language.

Tracer SC+ supports the following system applications:

- Area
- Variable Air Systems (VAS)
- Chiller Plant Control (CPC)
- Trim/Respond
- Linear Reset
- Demand Management

The Synchrony user-interface for each system component allows you to view status, configure the system and its functions, and to view and add members.

Area Application

Area is an application that resides on the Tracer SC+. The primary function of Area is to coordinate the start and stop of equipment based on a schedule stored in the Tracer SC+. An Area may consist of a single room, a group of rooms, a large open warehouse, a manufacturing space, or any grouping defined by a system user. Area allows such functions as synchronizing member setpoints and controlling a large number of devices to be performed as one efficient operation.

Area can be configured to use multiple algorithms, along with area temperatures and humidity inputs, to make an economizing decision.

Area also supports:

- Optimal start/stop
- Humidity pulldown
- Unoccupied Economizer (formally Night Purge)
- Unoccupied heating/cooling setpoints
- Unoccupied humidify/dehumidify
- Timed override functions
- Setpoint synchronization

Additionally, the Area application allows users to efficiently perform a single operation, such as changing a setpoint, creating a schedule, performing an override, and apply it to all members of the area. For more information, see the *Air Systems for Tracer SC+ Application Guide*, (BAS-APG036*-EN).

Trim/Respond Setpoint Reset Logic

Trim/Respond (T/R) logic is an application that resets a setpoint for pressure, temperature, or any other variable in a system. It changes the setpoint at a fixed rate (Trim) until a downstream device is no longer satisfied and generates a request. When a sufficient number of requests are present in a specific time frame, the setpoint is adjusted in response (Respond). The importance of each zone's requests can be adjusted to ensure that critical zones are always satisfied (Importance multiplier). When a sufficient number of requests no longer exist, the setpoint resumes changing (Trim) at its fixed rate. A running total of the requests generated by each zone is kept to identify zones that are driving the reset logic.

Trim/Respond logic is optimal for controlling a single variable that is subject to the requirements of multiple downstream zones and is prescribed by ASHRAE Guideline 36 as the method for resetting

Discharge Air Temperature, Static Pressure, Hot Water Temperature, Chilled Water Temperature, and others values in a system.

Several instances of T/R logic can be created on the same Tracer SC+ to control different setpoints. Users can select from the predefined resets described on ASHRAE Guideline 36 or create their own custom reset strategy. The following is the list of available options:

- Cooling Discharge Air Temperature Setpoint Reset
- Heating Discharge Air Temperature Setpoint Reset
- Duct Static Pressure Setpoint Reset
- Chilled Water Temperature Reset
- Chilled Water Plant Enable
- Chilled Water Pump Pressure Reset
- Hot Water Temperature Reset
- Hot Water Plant Enable
- Hot Water Pump Pressure Reset
- Custom Reset

For more information, see the *Air Systems for Tracer SC+ Application Guide* (BAS-APG036*-EN).

Linear Reset

Linear reset is a reset application that follows a linear function. An input is selected as the condition to reset one or several output setpoints. The slope of the linear function can be positive or negative depending on the values defined by the user (see the [Figure 15, p. 20](#)).

Note: *Linear Reset operates at priority 13. If used in conjunction with Trim/Respond, Linear Reset should be set to priority 9. This will allow the Linear Reset to modify the configuration parameters of the Trim/Respond application.*

Figure 15. Linear reset example

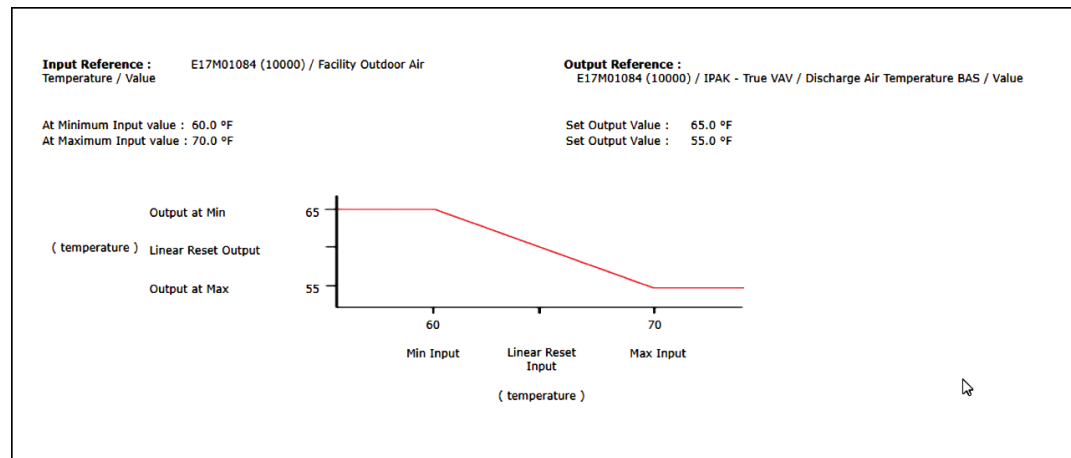

Chiller Plant Control (CPC) Application

The Chiller Plant Control (CPC) application coordinates chillers and provides system chilled water control.

The CPC application allows you to configure a chiller plant for optimal efficiency and reliability, and provides a means for you to monitor and control the daily operation. Depending upon the many possible chiller plant configurations and design differences, the CPC application can:

- Provide overall chiller plant status information and alarms to local and remote Tracer SC+ users.
- Enable or disable chiller plants.
- Start, stop, and monitor the status of system chilled water pumps.

- Calculate individual chilled water setpoints for individual chillers in series chiller plants
- Request when chillers are added or subtracted according to building load requirements and user-specified add and subtract logic
- Rotate chillers according to user-defined intervals
- Remove chillers from the rotation in the event

For more information, see the *Chiller Plant Application Guide*, (BAS-APG037*-EN).

Variable Air Systems (VAS) Application

The variable air system (VAS) coordinates the control of air handlers, rooftop units, and variable air volume terminal units. The Tracer SC+ VAS includes valuable tools to help manage tasks that were previously problematic and time consuming, such as:

- Determining Heat/Cool mode for changeover systems
- Coordinating AHU and VAV box operation
- Commissioning VAV boxes
- Scheduling common spaces
- Optimizing ventilation
- Optimizing duct static pressure

For more information, see the *Air Systems for Tracer SC+ Application Guide*, (BAS-APG036*-EN).

Demand Management Application

The Demand Management application provides users several options to automatically reduce the demand on their buildings. Demand Management allows users to configure their buildings for the following types or curtailment programs:

- Demand Limiting
- Demand Response – Day Ahead
- Demand Response – Day Of

Demand Limiting monitors the building demand and automatically applies **resources** – curtailment loads/strategies – to maintain the building demand at or below the user-defined demand limit. For more integrated applications, Trane offers two different types of demand response programs – both applied with Trane GridFlex, a cloud-based application designed to help users manage their demand.

Demand Response – Day Ahead programs notify users one day prior to a curtailment event, while **Demand Response – Day Of** events normally provide users notification in the range of 30 minutes up to a few hours.

For all program types, the demand management application controls the Curtailment Request point for each of the defined resources (loads). The user has the flexibility to define how the curtailment request controls an actual load or strategy. Users normally leverage existing standard tools and/or custom programs to accomplish the control of the equipment, device, or control strategy to reduce the demand on their facility. For more information, see the *Demand Management Application Guide*, (BAS-APG044*-EN).

Tracer Graphical Programming (TGP2)

Tracer Graphical Programming (TGP2) is a powerful graphical program that allows you to customize Tracer system applications. TGP2 routines are typically used for sequencing equipment, calculating setpoints and values, and performing shutdown sequences. See the following figure for an example.

Figure 16. TGP2 example

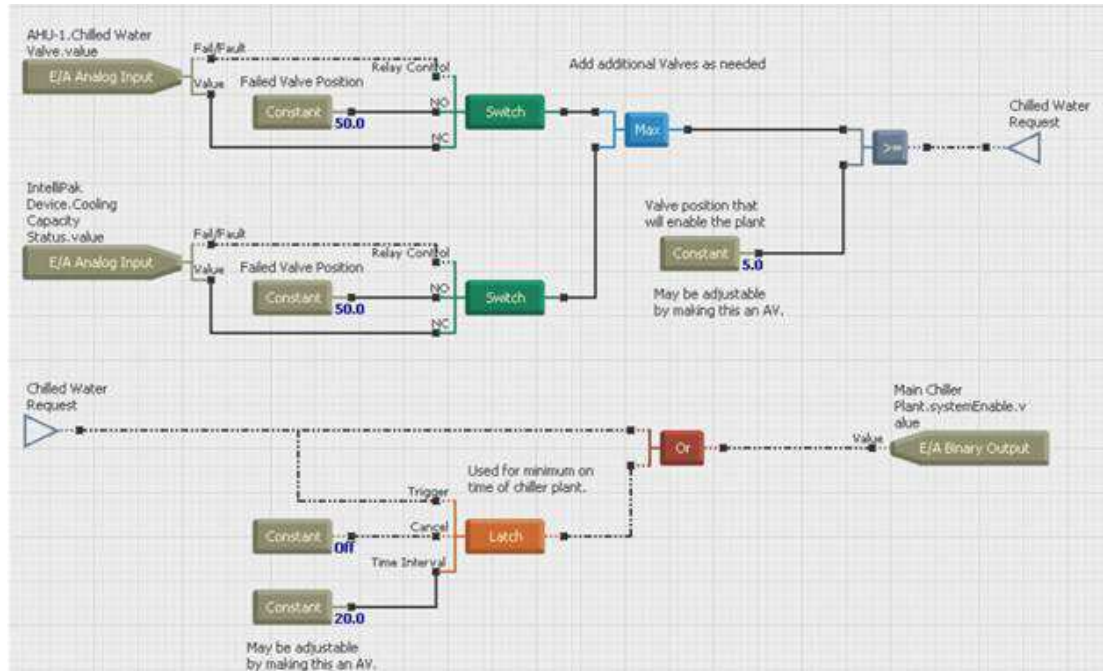



Unit Control

Unit controllers provide all necessary unit control functions. They operate associated unitary equipment, while ensuring that all built-in safety features are enabled and that diagnostics are issued. Each controller is designed to operate in stand-alone mode. Therefore, if system control fails, unit operation can continue. Unit controllers installed on a Tracer® SC+ can be a combination of the following BACnet®, LonTalk®, Air-Fi® wireless, and legacy unit controllers:

BACnet® (MS/TP) Unit Controllers Supported by Tracer SC+

Tracer UC factory and field programmable controllers, including UC210, UC400, UC600, UC800, Symbio™ 210, Symbio™ 400-B, Symbio™ 500, Symbio™ 700, and Symbio™ 800.

BACnet IP Unit Controllers Supported by Tracer SC+

Tracer UC600, Symbio™ 210e, Symbio™ 500, Symbio™ 700, Symbio™ 800, and Symbio™ factory and field programmable controllers.

Air-Fi® Wireless Unit Controllers Supported by Tracer SC+

All Tracer Symbio™ factory and field programmable controllers, including Symbio™ 800, Symbio™ 700.

LonTalk® Unit Controllers Supported by Tracer® SC+

- Tracer® AH540/541 air-handler controllers
- Tracer® MP501 multi-purpose controller
- Tracer® MP503 input/output module
- Tracer® MP580/581 programmable controller
- Tracer® VV550/551 VAV controller
- Tracer® ZN510/511 zone controller
- Tracer® ZN517 unit controller
- Tracer® ZN520/521 zone controller
- Tracer® ZN523 zone controller
- Tracer® ZN524 water-source heat pump unit controller
- Tracer® ZN525 zone controller
- Tracer® CH530 chiller controller
- Tracer® CH532 chiller controller
- LCI-C: LonTalk® communications interface for chillers
- LCI-I: LonTalk® communications interface for IntelliPak systems
- LCI-R: LonTalk® communications interface for ReliaTel systems
- LCI-V: LonTalk® communications interface for Voyager systems
- Trane TR200 Variable Frequency Drive (VFD)
- WAGO High Density I/O module (third-party)
- Trane® Enercept Flex Power and Energy Meters
- Trane E50 Series Power and Energy Meters
- Non-Trane LonTalk® devices using SCC, DAC, and chiller profiles, devices that support LonTalk® standard network generic variables, and devices with Standard Network Variable Types (SNVTs)

Trane Legacy Unit Controllers (Comm3/4) Supported by Tracer SC+

A maximum of 240 legacy devices can be installed and controlled through multiple Comm3/4 bridges (BTMB). There is no limit to the number of bridges allowed.



Unit Control

- Variable Air Volume (VAV I, II, III, IV)
- IntelliPak
- Voyager
- Commercial Self-Contained (CSC)
- Thermostat Control Module (TCM)
- Programmable Control Module (PCM)
- Universal Programmable Control Module (UPCM)
- Terminal Unit Controller (TUC)
- Centrifugal Chillers (UCP2)
- Helical Rotary Chillers (UCP2)
- CGX Chillers
- Series-R Chillers (RTA/RTW)



Resources

The following is a list of related Tracer SC+/Synchrony documentation and training resources.

- **Tracer SC+ System Controller Installation and Setup Guide (BAS-SVX077)**
Describes detailed configuration for network settings, Ethernet network wiring, and IT security.
- **Tracer SC+ System Controller Installation Sheet (BAS-SVN037)**
For mounting the enclosure and providing AC power.
- **Tracer Synchrony online help**
An online help system is included with the Tracer Synchrony user interface. Global help has a table of contents and is searchable. Contextual help is specific to the information on each page.
- **Tracer BAS Operator Suite (Mobile App) Getting Started Guide (BAS-SVU23)**
Describes how to obtain, download, install, and set up the mobile app.
- **BACnet MS/TP Wiring Best Practices and Troubleshooting (BAS-SVX51)**
Provides best practices, procedures, and troubleshooting for wiring BACnet unit controllers to a Tracer SC+ system controller.
- **Tracer SC+ Air Systems Application Guide (BAS-APG036)**
Describes variable-air-volume strategies for variable air systems. It also include constant-volume applications and area application strategies for Tracer SC+.
- **Tracer Graphical Programming (TGP2) Applications Guide (BAS-APG008)**
Describes how to use the TGP2 editor and typical implementation strategies and best practices for using TGP2.
- **Tracer TU Service Tool Getting Started Guide (TTU-SVN01)**
This document describes how to use the Tracer TU service tool to
 - Transfer programs to the Tracer SC+
 - Start the Tracer Graphical Programming (TGP2) Editor and the Tracer Graphics Editor from within Tracer TU
 - Backing up and restoring firmware and TGP2 programs
- **Trane University™**
Trane University offers a comprehensive portfolio of technical courses to help you effectively monitor and coordinate your HVAC equipment and systems.
<https://tranetechnologies.sharepoint.com/sites/trane-u/SitePages/Building%20System%20and%20Controls.aspx>



Specifications

This section contains specifications for Tracer® SC+ system controllers and for Tracer building automation systems.

Table 3. Controller specifications

Tracer SC+ Controller	
Web Browsers	<p>The most recent version of web browsers are tested with each new firmware release and will provide the best user experience. Utilization of other operating systems and browsers may work given our adherence to web standards, but this is not recommended/supported.</p> <p>Microsoft® Windows</p> <ul style="list-style-type: none"> • Google Chrome • Mozilla Firefox • Microsoft Edge (chromium) <p>Apple® Mac OS</p> <ul style="list-style-type: none"> • Google Chrome • Mozilla Firefox
Mobile Devices	<p>Apple® iOS/iPadOS</p> <ul style="list-style-type: none"> • Google Chrome • Mozilla Firefox • Safari <p>Android</p> <ul style="list-style-type: none"> • Google Chrome • Mozilla Firefox
Concurrent Users	<ul style="list-style-type: none"> • Five
Supported Languages	<p>Up to four languages are supported per Tracer SC+.</p> <ul style="list-style-type: none"> • English • Chinese (Simplified/Traditional) • French • French Canadian • Portuguese (Brazil) • German • Indonesian • Japanese • Korean • Spanish (Latin America) • Thai • Polish • Arabic

Table 3. Controller specifications (continued)

Power requirements	24 Vac @ 30 VA Class 2 transformer- Output:600mA at 24 Vdc@ 50C, Tracer® Plugin power supply w/single barrel connector - Output: 0.75A maximum at 24 Vdc @50C. Polarity: outer ground, inner 24 Vdc, PM014power supply module through inter-module-communication bus (IMC) - Output: 1.4A maximum @ 24 Vdc @ 70C
Operating environment	<ul style="list-style-type: none"> Temperature: From –40°F to 158°F (–40°C to 70°C) when 24 Vdc and 500 mA max. USB current. –40°C to 50°C (–40°F to 122°F) for all other configurations. Relative humidity: From 10% to 90%, non-condensing
Storage environment	<ul style="list-style-type: none"> Temperature: From –40°F to 158°F (–40°C to 70°C) Relative humidity: From 5% to 95%, non-condensing
Agency Listings	CE: <ul style="list-style-type: none"> The European Union (EU) Declaration of Conformity is available from your local Trane® office.
Processor	Arm A9 Cortex Dual Core
Memory	<ul style="list-style-type: none"> FLASH 4 GB eMMC SDRAM 1 GB DDR3
Battery	<ul style="list-style-type: none"> Coin cell battery (2032 type) that preserves regional settings (including date/time) for up to 30 days. Battery must be obtained from an outside vendor.
Protocol Communications	
BACnet	Tracer building automation systems communicates with BACnet devices that support: <ul style="list-style-type: none"> Communications based on the BACnet ASHRAE/ANSI standard ENV-1805-1/ENV-13321-1 User Datagram Protocol/Internet (UDP/IP) compatible network Tracer SC+ is listed by BACnet Test Labs (BTL) as a BACnet Building Controller (B-BC). Listing information can be found at: http://www.bacnetinternational.net
LonTalk®	Tracer building automation systems communicates with LonTalk devices that support: <ul style="list-style-type: none"> Communications based on the EIA-709.1 (LonTalk) standard LonTalk standard network variable types (SNVTs) FTT-10A or FT-X1 transceivers Twisted-pair physical media (Level 4 wiring) Note: Requires an external Tracer USB LonTalk module (part# X13651698001)
Modbus	<ul style="list-style-type: none"> Communications based on Modbus RTU defacto standard over EIA/TIA 485 (2–wire) Communications based on Modbus TCP defacto standard over 10BASE-T/100BASE-TX Transmission Control Protocol/Internet Protocol (TCP/IP) compatible network
Trane VRF	Tracer building automation systems communicates with XML devices that support: <ul style="list-style-type: none"> Communication based on Trane®/Mitsubishi Electric VRF Centralized Controllers (TE-200, TE-50, or TW-50) User Datagram Protocol/Internet (UDP/IP) Compatible network

Table 3. Controller specifications (continued)

Device Limits	<p>240 per facility - per device limits below (per link/per facility)</p> <p>BACnet Tracer UC210/400/600/800/BCI, Symbio™ 210/210e/400-B/500/700/800, BC12- 60/240 Non-Trane BACnet - 32/240 Trane Communicating Thermostats - 60/240 Air-Fi® (BACnet Zigbee) - 30/240 Symbio 800 - 60/240</p> <p>LonTalk® AH/CH/VV/ZN Series - 120/240 MP503 - 120/240 MP580 - 20/40 Trane Communicating Thermostats - 120/240 Symbio 800 - 120/240</p> <p>Modbus® TCP - 240/240 RTU - 30/90</p> <p>Trane VRF XML/IP – 240/240</p> <p>Legacy Trane Comm 2 - 240 through Comm 2 bridge Comm 3 - 240 through BMTB Comm 4 - 240 through BMTB</p>
Medium Enclosure (optional)	
NEMA Type	NEMA-1
Weight	14 lb. (6.5 kg)
Mounting	Wall-mounted with #10 (5 mm) screws and #10 wall anchors. Mounting surface must be able to support 60 lb. (28 kg)
Large Enclosure (optional)	
NEMA Type	NEMA-1
Weight	50 lb (23.0 kg)
Mounting	Wall-mounted with #10 (5 mm) screws and #10 wall anchors. Mounting surface must be able to support 120 lb. (56 kg)

Hardware Components

The Tracer SC+ system controller and additional hardware options are described in this section.

- Tracer SC+ system controller components
- Trane PM014 power supply module
- Tracer BACnet terminator
- Medium enclosure
- Large enclosure

Tracer® SC+ Components

The Tracer SC+ system controller is equipped with the components shown in the following figure. The table that follows provides descriptions.

Figure 17. Tracer SC+ components

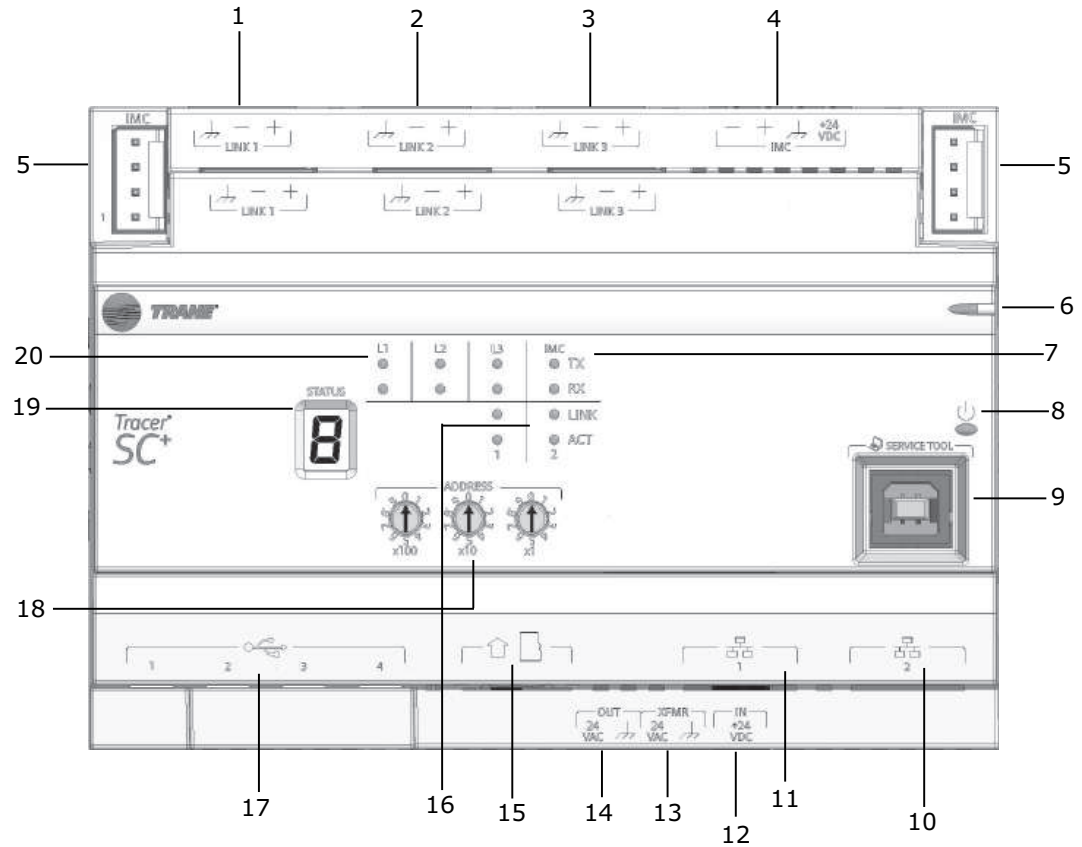

Callout Number in Figure	Tracer® SC+ Components Description
1	Communication Link 1: RS-485 port configurable for BACnet MS/TP or Modbus RTU
2	Communication Link 2: RS-485 port configurable for BACnet MS/TP or Modbus RTU
3	Communication Link 3: RS-485 port configurable for BACnet MS/TP or Modbus RTU
4	4-pin IMC terminal block port
5	IMC pin connection
6	Status LED

Callout Number in Figure	Tracer® SC+ Components Description
7	IMC LEDs
8	Power button
9	USB service tool port
10	Ethernet network connection 2: supports TCP/IP, BACnet/IP, BACnet/SC, and Modbus TCP communication
11	Ethernet network connection 1: supports TCP/IP, BACnet/IP, BACnet/SC, and Modbus TCP communication
12	24 Vdc power adapter port: supports external 24Vac/dc power adapter
13	24 Vac input
14	24 Vac output
15	Micro SD card slot: support for backups (up to 10 backup files, FIFO)
16	Ethernet LEDs
17	USB 2.0 ports: support for Tracer USB LonTalk® module, WiFi and USB mass storage
18	Rotary switches
19	7-segment display
20	RS-485 communication link LEDs

Dimensions

Figure 18. Tracer SC+ system controller dimensions

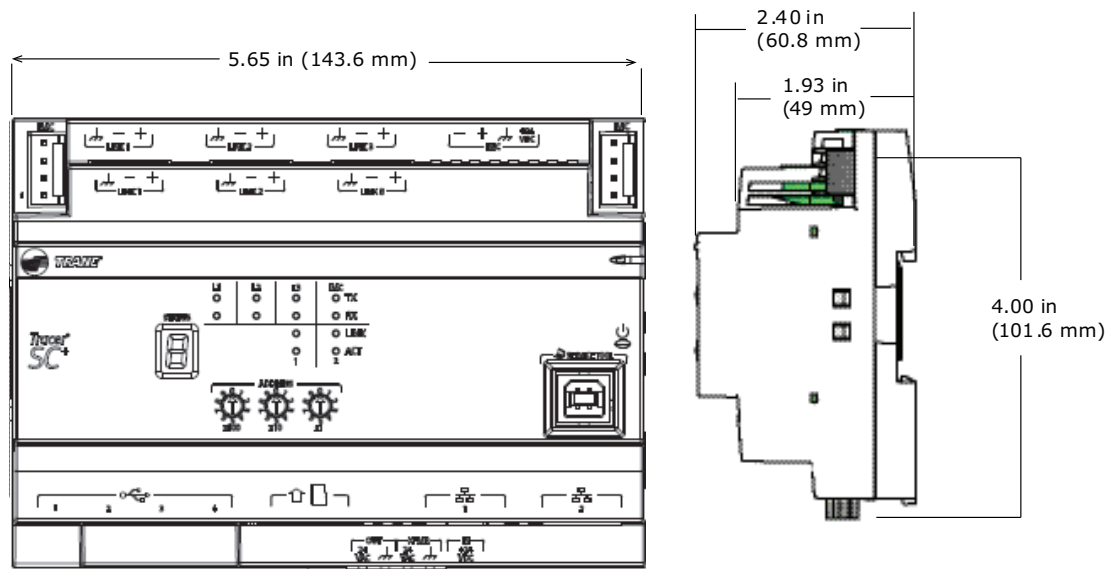

Tracer® SC+ Power Supply

The Tracer SC+ controller can be powered in one of the following three ways.

- 24 Vac at 30 VA Class 2 Transformer with 4-position terminal block.
 - Output: 600 mA at 24 Vdc at 50°C
- Tracer Plugin power supply with single barrel connector.
 - Output: 0.75 A maximum at 24 Vdc at 50°C. Polarity: outer ground, inner 24 Vdc
- PM014 power supply module through inter-module-communication bus (IMC).

- Output: 1.4 A maximum at 24 Vdc at 70°C. Refer to the *PM014 Power Supply IOM*, (BAS-SVX33*-EN).
- Tracer SC+ Min/Max Ratings: 24 Vac +/- 15%, 24 Vdc +/- 10%

Direct Current Requirements for SC+ and Peripherals

The Tracer SC+ output is 24 Vdc. [Table 4, p. 31](#) provides the current draw per component for DC power budgeting.

Table 4. 24 Vdc current draw per component on a Tracer SC+ controller

Component	Current withdraw
SC+ controller	150 mA
See below "USB Port Power Requirements," p. 31	See below "USB Port Power Requirements," p. 31
New WCI (see note)	10 mA
XM30	110 mA
XM32	100 mA

Notes:

- *New WCI part numbers: X13790901030 (Field Installed Indoor), X13790941030 (Field Installed Outdoor), X13790902030 (Service Indoor Flush), X13790903030 (Factory Indoor), and X13790904030 (Factory Indoor Flush).*
- *The XM70 and XM90 require 24 Vac. Do not wire the XM70 and XM90 to the SC+ power source.*

Tracer SC+ DC Power Budget

Depending on the power source, Tracer SC+ has a maximum current available for peripheral devices. Perform a power budget if you have more than three external devices connected through the IMC.

- AC Powered
 - The preferred power method is to provide 24 Vac from a transformer. Using the values from [Table 4, p. 31](#), calculate the current draw for all the components connected to the SC+. If the total exceeds 600 mA, use a PM014 module or a plug-in power supply.
- Tracer Plug-in power supply
 - Using the values from [Table 4, p. 31](#), calculate the current draw for all the components connected to the SC+. The total cannot exceed 0.75 A. If the sum exceeds 750 mA, use a PM014 module.
- PM014 powered
 - Using the values from [Table 4, p. 31](#), calculate the power draw for all the components connected to the SC+. The total cannot exceed 1.4 A.

USB Port Power Requirements

The table below states the 5 Vdc power available for all four USB Ports. No single port can support a sustained load 500 mA, or 510 mA intermittent. Overloading a port, or ports may cause the USB load switch to shut down. The USB load switch will shut down very quickly during a direct short circuit.

Table 5. 5 Vdc current draw per component on the Tracer® SC+ USB ports

Component	Current Withdraw
Trane Wi-Fi Module (X13651743001)	250 mA
Trane U60 LON Adapter	110 mA
Trane USB Cellular Module (Verizon, USA)	450 mA

Tracer BACnet Terminator

A Tracer BACnet® terminator is placed at the end of each communication link in order to decrease communication signal degradation. Refer to the *BACnet® Wiring Best Practices and Troubleshooting Guide*, (BAS-SVX51*-EN).

Figure 19. BACnet terminator (wiring)

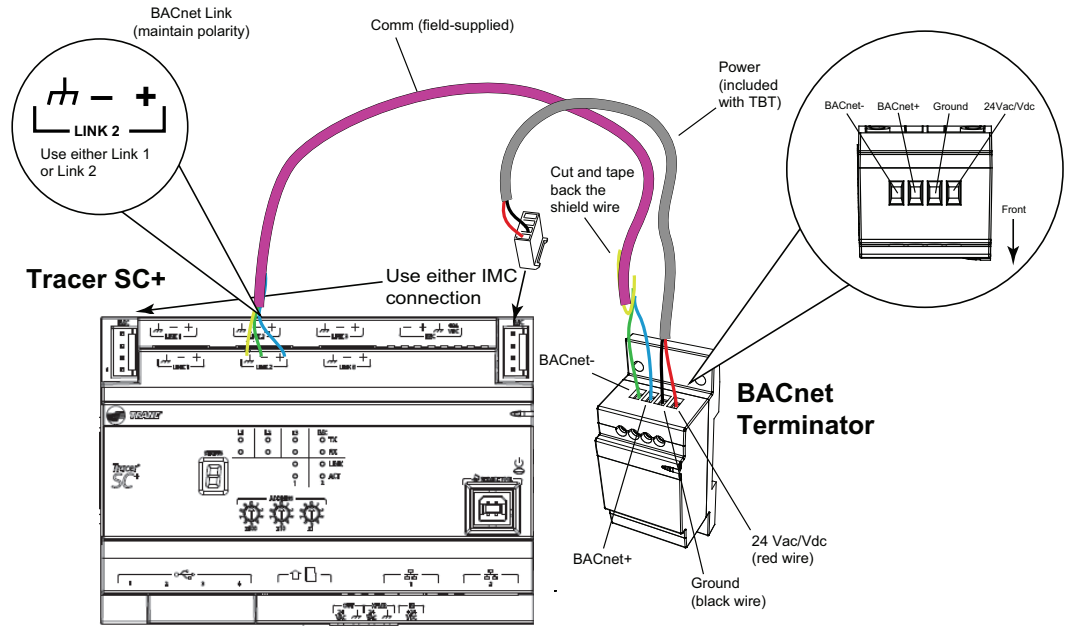

Medium/Large Enclosure (Optional)

Table 6. Medium/Large enclosure

Type	Details	Order number
Medium Enclosure, 120 Vac with 1 outlet	Tracer DIN-mounted controller	X13651559010
Medium Enclosure, 120 Vac with 3 outlets	Tracer DIN-mounted controller	X13651699001
Medium Enclosure, 230 Vac with 0 outlet	Tracer DIN-mounted controller	X13651560010
Large Enclosure, 120 Vac	Tracer DIN-mounted controller with solid door	X1365155201
Large Enclosure, 120 Vac	Tracer DIN-mounted controller with display-capable door	X1365155301
Large Enclosure, 230 Vac Dual Transformer	Tracer DIN-mounted controller with solid door	X1365155401
Large Enclosure, 230 Vac Dual Transformer	Tracer DIN-mounted controller with display-capable door	X1365155501

Large Enclosure (Optional)

The large enclosure for Tracer DIN-mounted controllers is available in the following:

- 120 Vac
 - solid door (*order number: X1365155201*)
 - display-capable door (*order number: X1365155301*)
- 230 Vac Dual Transformer

- solid door (order number: X1365155401)
- display-capable door (order number: X1365155501)

Figure 20. Large enclosure (dimensions)

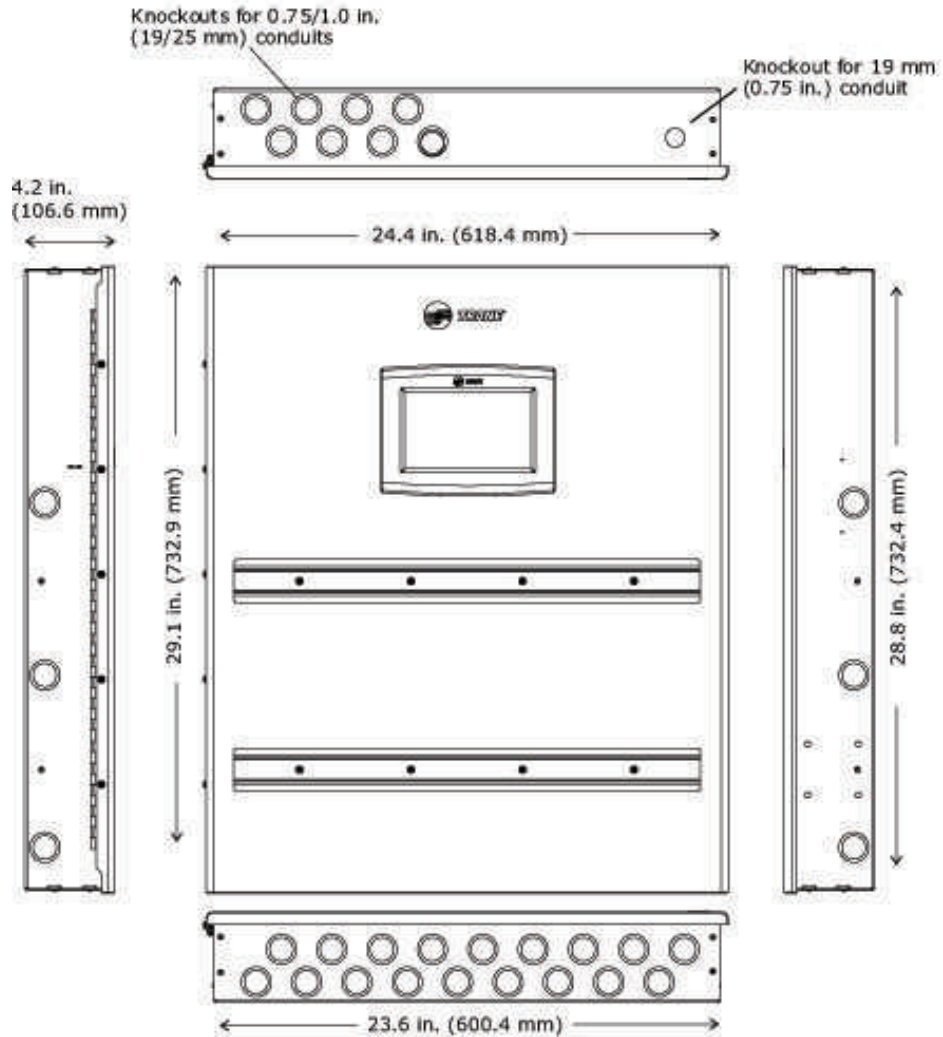



Notes

Trane - by Trane Technologies (NYSE: TT), a global innovator - creates comfortable, energy efficient indoor environments for commercial and residential applications. For more information, please visit trane.com or tranetechnologies.com.

Trane has a policy of continuous product and product data improvements and reserves the right to change design and specifications without notice. We are committed to using environmentally conscious print practices.

BAS-PRC087E-EN 30 Sep 2023
Supersedes BAS-PRC087D-EN (August 2021)

©2023 Trane